

**FCJJ-40**



## PRODUCT DESCRIPTION

The Renewable Energy Box provides a complete understanding of how fuel cell technology interacts with renewable energy sources to create an entirely sustainable power grid. Solar power, wind energy, kinetic energy from a hand crank and a demonstration of the incredible storage potential of a super capacitor. There's a range of fuel cells to compare: PEM hydrogen fuel cell, the salt water fuel cell and a direct ethanol fuel cell. Countless experiments, so many scientific principles at work and plenty of space for creativity.

## FEATURES

- ✓ Fuel cell science from fuel cell experts: PEM, direct ethanol, salt water and reversible fuel cells in one kit.
- ✓ Introduction to renewable energy: solar panel, wind turbine, temperature cell and hand crank.
- ✓ Includes super capacitor to demonstrate the latest in energy storage technology.
- ✓ Includes CD with curriculum content for 40 hours of classroom activities.



## LANGUAGE PACK

- ✓ Assembly Guide :
- ✓ Technical Support Guide:

## ADD-ON

Make your Horizon Energy Box truly energy independent with the optional addition of HYDROFILL PRO desktop refueling station.



## EXPERIMENTS AND ACTIVITIES

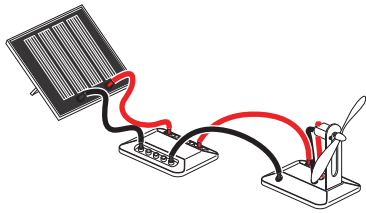

### ✓ Solar energy experiments

1. The effect of heat and cooling on solar panels
2. The effect of shade on solar panels
3. The effect of tilt angle on solar panels
4. Finding the solar panel's maximum power point

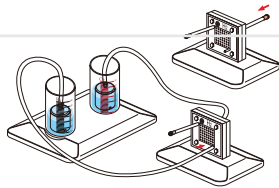

### ✓ Hydrogen energy experiments

1. Electrolysis mode: generating hydrogen and oxygen from water
2. Fuel cell mode: generating electricity from hydrogen and oxygen
3. Determining the minimum voltage for water decomposition
4. Polarization states for hydrogen fuel cells

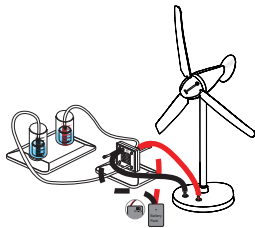

### ✓ Wind energy experiments

1. How many blades are best - 1, 2, 3 ... More?
2. Using three different curved blade shapes
3. Using blades you make yourself
4. Turbine efficiencies
5. Measuring rpm
6. Tuning for maximum power
7. How blade angle or pitch affects output power
8. The process of hydrogen generation

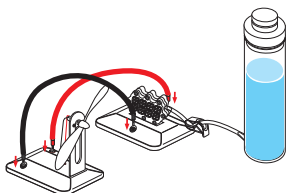

### ✓ Bio-energy experiments

1. Create electricity from ethanol and water
2. Exploring polarity
3. Ethanol fuel consumption
4. Exploring the effect of varying fuel concentrations
5. Create electricity from wine and beer
6. Exploring the effects of temperature

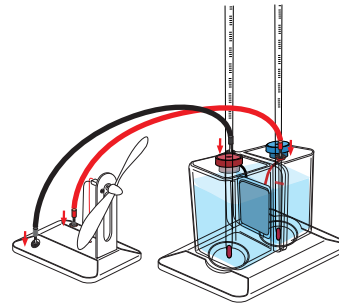

### ✓ Thermal energy experiments

1. Power a fan with two heat sources
2. Analyze power generation with the Renewable Energy Monitor
3. Understand thermoelectric effect

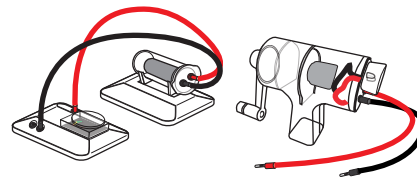

### ✓ Mechanical / electrical energy experiments

1. Explore the concept of hand crank energy generation
2. Explore the concept of super capacitor energy storage
3. Power a fan with electrical energy from the super capacitor
4. Power a fan with mechanical energy from the hand crank

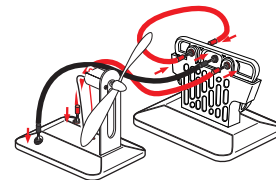

### ✓ Salt water energy experiments

1. Create energy from salt water solution and power a fan
2. Analyze current and voltage variation using different salt concentrations
3. Analyze current and voltage variations using different temperatures
4. Analyze current and voltage variations using different fuel volumes

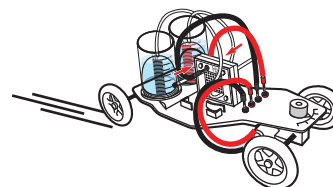

### ✓ Multi energy powered car experiments

1. Power a car with a hydrogen fuel cell (reversible and mini fuel cell)
2. Power a car with a salt water fuel cell
3. Power a car with solar energy
4. Power a car with a super capacitor and hand crank
5. Power a car with different forms of hydrogen (hydrogen gas and hydrogen hydride)



## CONTENT

1. Hand crank generator
2. Ethanol fuel cell module
3. Reversible fuel cell
4. Salt water fuel cell
5. Multi car chassis
6. Battery pack
7. LED module
8. Mini fuel cell base
9. Potentiometer
10. Super capacitor
11. Water tank base
12. Solar panel
13. HYDROSTIK PRO
14. Pressure regulator
15. Mini fuel cell
16. Thermoelectrical system
17. Rotor Base
18. Blade holder
19. Assembly lock
20. Main body assembly
21. Variable resistor module
22. Base assembly
23. Blade A (3pcs)
24. Blade B (3pcs)
25. Blade C (3pcs)
26. Windpitch post assembly
27. Spanner
27. Spanner
28. Screwdriver
29. Water & oxygen tank
30. Water & hydrogen tank
31. Fuel solution container
32. HYDROSTIK PRO U locker
33. HYDROSTIK PRO suport
34. Syringe
35. Fuel cell base
36. Multi connection base
37. Solar panel support
38. Heavy fan module
39. Fan module
40. Fan blade
41. Ethanol fuel tank with lid
42. Wires
43. Wheel
44. Purging valve
45. Clamp
46. PH paper
47. Silicon tubes
48. Red & black pins
49. Fan blade & wheel adapter
50. Windpitch post screws
51. Reversible fuel cell
52. Thermometers
53. REM USB cable
54. REM

## CERTIFICATION

CoC, ROHS, EN71:PART1;PART2;PART3, EN62115, PHTH-EU, ASTM F963, CPSIA-LEAD, CPSIA-LEAD, CPSIA-PHTHALATES, REACH.

## PACKING INFORMATION

<b>Case Pack Quantity</b> (units):	1
<b>Master Pack Quantity</b> (units):	1
<b>Packaging Type:</b>	cardboard
<b>20' Container</b> (units):	270
<b>40' Container</b> (units):	550
<b>Unit Box Length</b> (cm/in):	63 / 24.8
<b>Unit Box Width</b> (cm/in):	44 / 17.3
<b>Unit Box Height</b> (cm/in):	35 / 13.8
<b>Unit Volume</b> (Litres/Cubic Meters):	97.0 / 0.097
<b>Unit Box Weight</b> (kg/lbs):	6.6 / 14.6
<b>Case Pack Length</b> (cm/in):	63 / 24.8
<b>Case Pack Width</b> (cm/in):	44 / 17.3
<b>Case Pack Height</b> (cm/in):	35 / 13.8
<b>Case Pack Volume</b> (Litres/Cubic Meters):	97.0 / 0.097
<b>Case Pack Weight</b> (kg/lbs):	6.6 / 14.6

\*The cartons' size may vary between ±1-2 cm.

## LOGISTICS INFORMATION

<b>Item UPC-Code:</b>	6942503405309
<b>Item HS-Code:</b>	-
<b>Manufactured in:</b>	Shanghai, China
<b>Local Warehouse</b>	Prague, Czech Republic
<b>FOB Harbor:</b>	Los Angeles, USA
<b>First Ship Date:</b>	available now
<b>Minimum Order:</b>	1