

Features

- ◆ Rugged, compact metal case
- ◆ Screw terminal adaptor available for easy connection
- ◆ Optional DIN-rail mounting kit
- ◆ Ultra wide 4:1 input voltage range
- ◆ Full load operation up to 60°C with convection cooling
- ◆ Undervoltage lockout
- ◆ Reverse input voltage protection
- ◆ Input protection filter
- ◆ 3-year product warranty

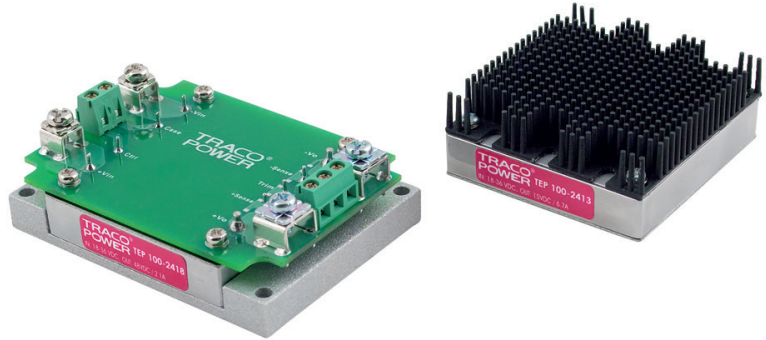

(Models pictured with chassis mount adaptor / optional heatsink)

The TEP-75WI Series is a family of isolated high performance DC/DC converter modules with ultra-wide 4:1 input voltage ranges which come in a rugged, sealed metal case. These converters are suitable for a wide range of applications, but the product is designed particularly also for industrial applications where often no PCB mounting is possible but the module has to be mounted on a chassis. Four threaded M3 inserts in the module makes chassis mount or attachment of a heatsink for optimal thermal management very simple. For easy connection there is also an unique adaptor available with screw terminals. A very high efficiency allows an operating temperature up to +60°C with natural convection cooling without power derating. Further features include output voltage trimming, Remote On/Off and under voltage lockout. The very wide input voltage range and reverse input voltage protection make these converters also an interesting solution for battery operated systems.

Table of contents

Output Specification	P2	Output Over Voltage Protection	P58
Input Specification	P3	Over Temperature Protection	P58
General Specification	P5	Thermal Considerations	P59
Environmental Specification	P6	Heat-Sink Considerations	P60
EMC characteristic	P6	Remote ON/OFF Control	P61
Characteristic Curves	P7	Mechanical Data	P62
Testing Configurations	P49	Recommended Pad Layout	P65
EMI Considerations	P50	Soldering Considerations	P66
Output Voltage Adjustment	P55	Packaging Information	P67
Remote Sense	P57	Part Number Structure	P68
Input Source Impedance	P57	Safety and Installation Instruction	P69
Output Over Current Protection	P58	MTBF and Reliability	P69
Short Circuitry Protection	P58		

Output Specification

Parameter	Device	Min	Typ	Max	Unit
Output Voltage ($V_{in} = V_{in(nom)}$, Full Load , $T_A = 25C^\circ$)	TEP 75-xx10WI	3.267	3.3	3.333	VDC
	TEP 75-xx11WI	4.95	5	5.05	VDC
	TEP 75-xx12WI	11.88	12	12.12	VDC
	TEP 75-xx13WI	14.85	15	15.15	VDC
	TEP 75-xx15WI	23.76	24	24.24	VDC
	TEP 75-xx16WI	27.72	28	28.28	VDC
	TEP 75-xx18WI	47.52	48	48.48	VDC
Voltage Adjustability (see page 55)	All	-20		+10	%
Output Regulation Line ($V_{in(min)}$ to $V_{in(max)}$ at Full Load) Load (0% to 100% of Full Load)	All		± 0.1	± 0.2	%
	All		± 0.1	± 0.2	%
Output Ripple & Noise ($V_{in} = V_{in(nom)}$, Full Load , $T_A = 25C^\circ$). Peak to Peak (5Hz to 20MHz bandwidth) Measured with a ripple & noise test board: $C_{OUT,ext.} = 4.7\mu F$ 50V 1812 X7R MLCC $C_{OUT,ext.} = 2.2\mu F$ 100V 1812 X7R MLCC	TEP 75-xx10WI		75	100	mV _{P-P}
	TEP 75-xx11WI		75	100	mV _{P-P}
	TEP 75-xx12WI		100	125	mV _{P-P}
	TEP 75-xx13WI		100	125	mV _{P-P}
	TEP 75-xx15WI		200	250	mV _{P-P}
	TEP 75-xx16WI		200	250	mV _{P-P}
	TEP 75-xx18WI		300	350	mV _{P-P}
Temperature Coefficient	All	-0.02		+0.02	%/K
Output Voltage Overshoot ($V_{in} = V_{in(min)}$ to $V_{in(max)}$, Full Load , $T_A = 25C^\circ$)	All		0	5	% Vout
Dynamic Load Response ($V_{in} = V_{in(nom)}$, $T_A = 25C^\circ$) Load step change between 75% to 100% of Full Load Peak Deviation	TEP 75-xx10WI		200		mV
	TEP 75-xx11WI		200		mV
	TEP 75-xx12WI		350		mV
	TEP 75-xx13WI		400		mV
	TEP 75-xx15WI		950		mV
	TEP 75-xx16WI		950		mV
	TEP 75-xx18WI		1500		mV
Setting Time ($V_{out} < 10\%$ peak deviation)	All		200		μS

Output Specification (continued)					
Parameter	Device	Min	Typ	Max	Unit
Output Current	TEP 75-xx10WI	0		20.0	A
	TEP 75-xx11WI	0		15.0	A
	TEP 75-xx12WI	0		6.3	A
	TEP 75-xx13WI	0		5.0	A
	TEP 75-xx15WI	0		3.2	A
	TEP 75-xx16WI	0		2.7	A
	TEP 75-xx18WI	0		1.6	A
			0		
Output Capacitor Load	TEP 75-xx10WI			60600	μF
	TEP 75-xx11WI			30000	μF
	TEP 75-xx12WI			5250	μF
	TEP 75-xx13WI			3330	μF
	TEP 75-xx15WI			1330	μF
	TEP 75-xx16WI			960	μF
	TEP 75-xx18WI			330	μF
Output Over Voltage Protection (Hiccup Mode)	TEP 75-xx10WI	3.795		4.29	VDC
	TEP 75-xx11WI	5.75		6.50	VDC
	TEP 75-xx12WI	13.80		15.60	VDC
	TEP 75-xx13WI	17.25		19.50	VDC
	TEP 75-xx15WI	27.60		31.20	VDC
	TEP 75-xx16WI	32.20		36.40	VDC
	TEP 75-xx18WI	55.20		62.40	VDC
Output Over Current Protection (Hiccup Mode)	TEP 75-24xxWI	110		140	% FL
	TEP 75-48xxWI				
	TEP 75-72xxWI		150		
Output Short Circuit Protection (Hiccup Mode)	All		Automatics recovery		

Input Specification					
Parameter	Device	Min	Typ	Max	Unit
Operating Input Voltage	TEP 75-24xxWI	9	24	36	VDC
	TEP 75-48xxWI	18	48	75	VDC
	TEP 75-72xxWI	43	110	160	VDC
Input Voltage Continuous	TEP 75-24xxWI			40	VDC
	TEP 75-48xxWI			80	VDC
	TEP 75-72xxWI			160	VDC
Transient (100mS maximum)	TEP 75-24xxWI			50	VDC
	TEP 75-48xxWI			100	VDC
	TEP 75-72xxWI			185	VDC
Input Standby Current ($V_{in} = V_{in(nom)}$, No Load , $T_A = 25C^\circ$)	TEP 75-2410WI		85		mA
	TEP 75-2411WI		120		mA
	TEP 75-2412WI		185		mA
	TEP 75-2413WI		185		mA
	TEP 75-2415WI		85		mA
	TEP 75-2416WI		85		mA
	TEP 75-2418WI		85		mA
	TEP 75-4810WI		60		mA
	TEP 75-4811WI		60		mA

Input Specification (continued)					
Parameter	Device	Min	Typ	Max	Unit
	TEP 75-4812WI		90		mA
	TEP 75-4813WI		50		mA
	TEP 75-4815WI		50		mA
	TEP 75-4816WI		50		mA
	TEP 75-4818WI		50		mA
	TEP 75-7210WI		10		mA
	TEP 75-7211WI		10		mA
	TEP 75-7212WI		10		mA
	TEP 75-7213WI		10		mA
	TEP 75-7215WI		10		mA
	TEP 75-7216WI		10		mA
	TEP 75-7218WI		10		mA
Input reflected ripple current (see page 49) (5 to 20MHz, 12 μ H source impedance)	All		50		mA _{p-p}
Start Up Time (Vin = Vin(nom) and constant resistive load)					
Power up	TEP 75-24xxWI		25	40	mS
	TEP 75-48xxWI		25	40	mS
	TEP 75-72xxWI		60	80	mS
Remote ON/OFF	TEP 75-24xxWI		25	40	mS
	TEP 75-48xxWI		25	40	mS
	TEP 75-72xxWI		60	80	mS
Remote ON/OFF (see page 61) (The CTRL pin voltage is referenced to -INPUT) Negative logic (Standard) : Device code without Suffix DC-DC ON (Short) DC-DC OFF (Open) Positive logic (Option) : Device code with Suffix "-P" DC-DC ON (Open) DC-DC OFF (Short) Remote Off state Input Current Input Current of Remote Control Pin	All	0 3 3 0 -0.5		1.2 12 12 1.2 1	VDC VDC VDC VDC mA mA
Under Voltage Lockout Turn-on Threshold	TEP 75-24xxWI			9	VDC
	TEP 75-48xxWI			18	VDC
	TEP 75-72xxWI			43	VDC
Under Voltage Lockout Turn-off Threshold	TEP 75-24xxWI		7.5		VDC
	TEP 75-48xxWI		16		VDC
	TEP 75-72xxWI		36		VDC

General Specification					
Parameter	Device	Min	Typ	Max	Unit
Efficiency ($V_{in} = V_{in(nom)}$, Full Load , $T_A = 25C^\circ$)	TEP 75-2410WI		87		%
	TEP 75-2411WI		88		%
	TEP 75-2412WI		88		%
	TEP 75-2413WI		88		%
	TEP 75-2415WI		87		%
	TEP 75-2416WI		87		%
	TEP 75-2418WI		87		%
	TEP 75-4810WI		88		%
	TEP 75-4811WI		90		%
	TEP 75-4812WI		90		%
	TEP 75-4813WI		89		%
	TEP 75-4815WI		88		%
	TEP 75-4816WI		88		%
	TEP 75-4818WI		87		%
	TEP 75-7210WI		89		%
	TEP 75-7211WI		91		%
	TEP 75-7212WI		91		%
	TEP 75-7213WI		91		%
TEP 75-7215WI		90		%	
TEP 75-7216WI		90		%	
TEP 75-7218WI		90		%	
Isolation voltage (Basic Insulation)(1 minute) Input to Output Input (Output) to Case	All	2250 1600			VDC VDC
Isolation resistance	All	1			GΩ
Isolation capacitance	All			2500	pF
Switching Frequency	All	270	300	330	KHz
Weight	All		97		g
MTBF Bellcore TR-NWT-000332, $T_c = 40C^\circ$, MIL-HDBK-217F	All		1.010×10^6 7.416×10^4		hours hours
Case material	TEP 75-24xxWI TEP 75-48xxWI TEP 75-72xxWI		Metal Metal Aluminum base-plate with plastic case		
Base material	TEP 75-24xxWI TEP 75-48xxWI		FR4 PCB FR4 PCB		
Potting material	All		Silicon (UL94-V0)		
Dimensions	All		2.40 X 2.28 X 0.50 (61.0×57.9×12.7)		Inch (mm)

Environmental Specification					
Parameter	Model	Min	Typ	Max	Unit
Operating ambient temperature (with derating) *	All	-40		85	C°
Operating case temperature	All	-40		105	C°
Storage temperature	All	-55		125	C°
Over temperature protection (see page 58)	All		115		C°
Thermal impedance without Heat-sink	All	6.7			K/ Watt
With 0.24" Height Heat-sink		5.4			K/ Watt
With 0.45" Height Heat-sink		4.7			K/ Watt
Relative humidity	All	5		95	% RH
Thermal shock	MIL-STD-810F				
Vibration	MIL-STD-810F				

* Test condition with vertical direction by natural convection (20FLM)

EMC characteristic			
Environmental Phenomena	Basic Standard	Severity	Performance Criteria
EMI Standard (see page 50) Option TF	EN55011、EN55022 EN55011、EN55022		Class A Class A
ESD	EN61000-4-2	Air Contact ±8KV ±6KV	A
Radiated immunity	EN61000-4-3	20V/m	A
Fast transient	EN61000-4-4	±2KV	A
Surge	EN61000-4-5	EN55024 ±1KV EN50155 ±2KV	A A
Conducted immunity	EN61000-4-6	10Vr.m.s	A

** The TEP 75WI series meets EMC characteristics only with external components connected before the input pin to the converter.
If customer only need to meet EN61000-4-4, EN61000-4-5, an external input filter capacitor is required. Recommended 1 pcs of aluminum electrolytic capacitor (Nippon Chemi-con KY series, 220μF/100V, ESR 48mΩ) to connect in parallel. Recommended 2 pcs of aluminum electrolytic capacitor (Nippon Chemi-con KXJ series, 150μF/200V) to connect in parallel.

Characteristic Curves

All test conditions are at 25°C. The figures are identical for TEP 75-2410WI

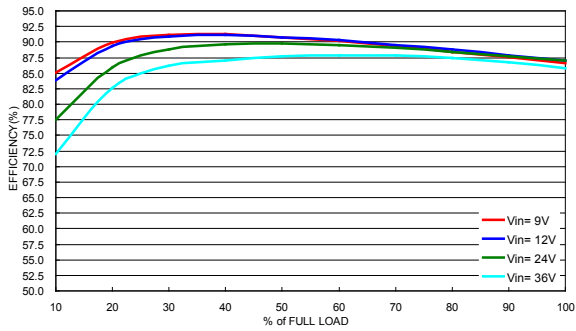

Efficiency versus Output Current

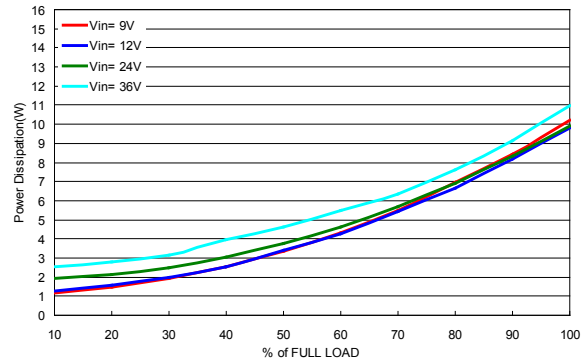

Power Dissipation versus Output Current

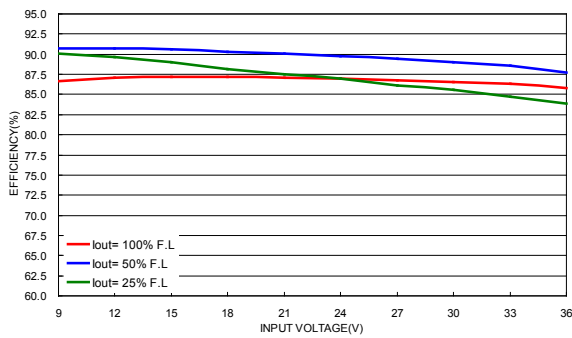

Efficiency versus Input Voltage. Full Load

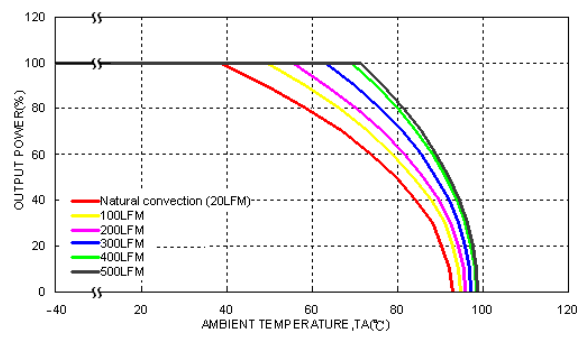

Derating Output Current versus Ambient Temperature with Airflow , Vin = Vin(nom)

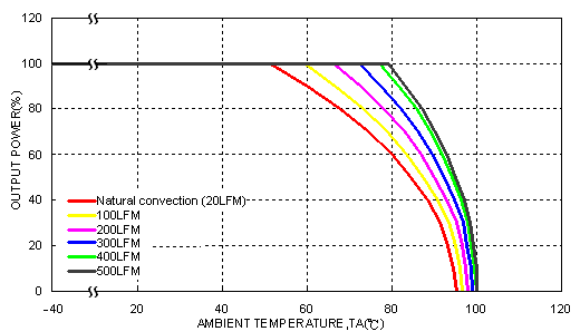

Derating Output Current versus Ambient Temperature with 0.24" Heat-Sink and Airflow , Vin = Vin(nom)

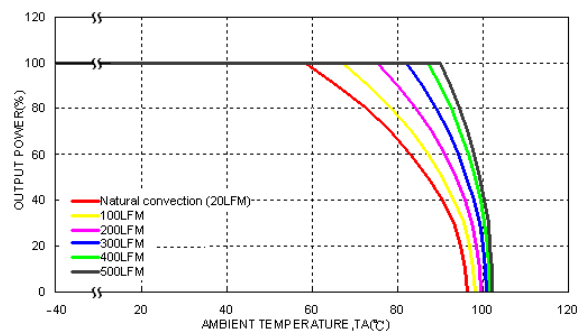

Derating Output Current versus Ambient Temperature with 0.45" Heat-Sink and Airflow , Vin = Vin(nom)

Characteristic Curves

All test conditions are at 25°C. The figures are identical for TEP 75-2410WI (continued)

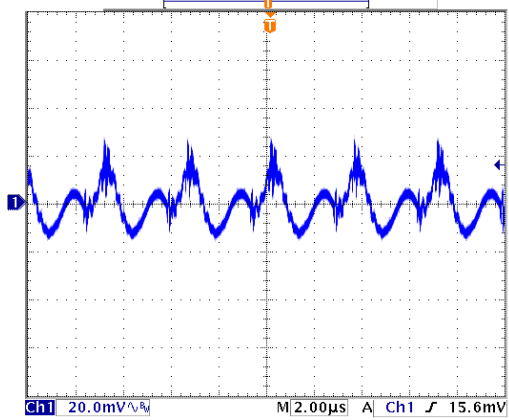

Typical Output Ripple and Noise.
Vin = Vin(nom), Full Load

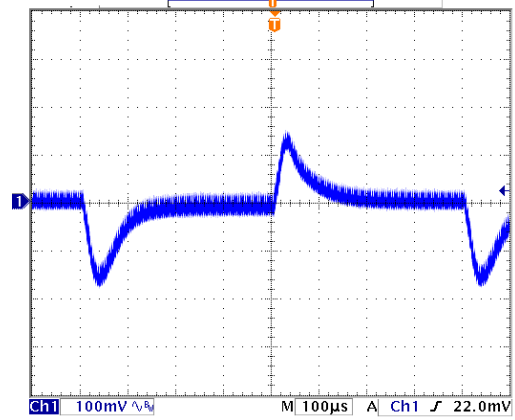

Transient Response to Dynamic Load Change from 100% to 75% to 100% of Full Load, Vin = Vin(nom)

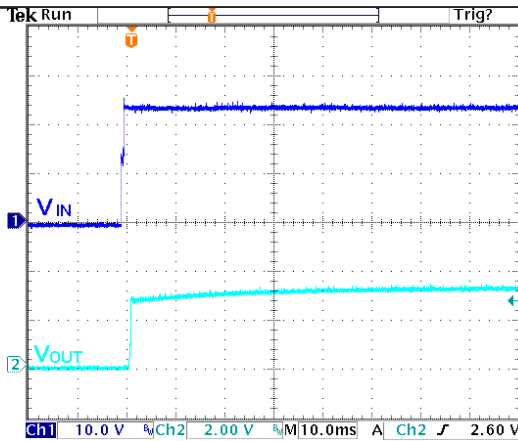

Typical Input Start-Up and Output Rise Characteristic
Vin = Vin(nom), Full Load

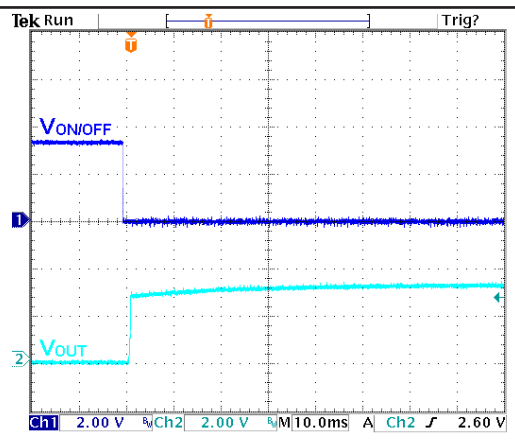

Using ON/OFF Voltage Start-Up and Vo Rise Characteristic
Vin = Vin(nom), Full Load

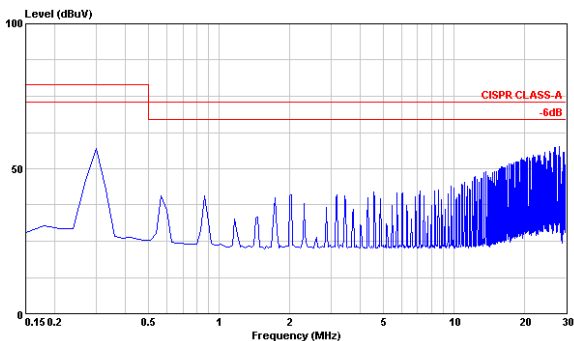

Conduction Emission of EN5022 Class A
Vin = Vin(nom), Full Load

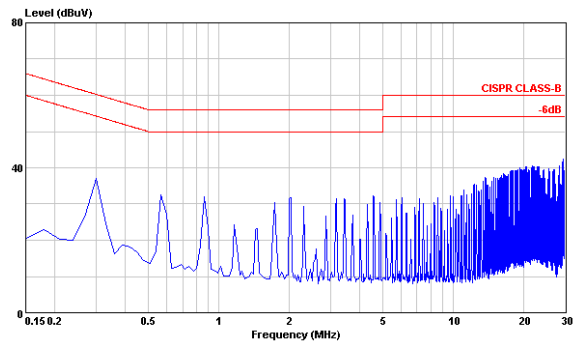

Conduction Emission of EN5022 Class B
Vin = Vin(nom), Full Load

Characteristic Curves

All test conditions are at 25°C. The figures are identical for TEP 75-2411WI

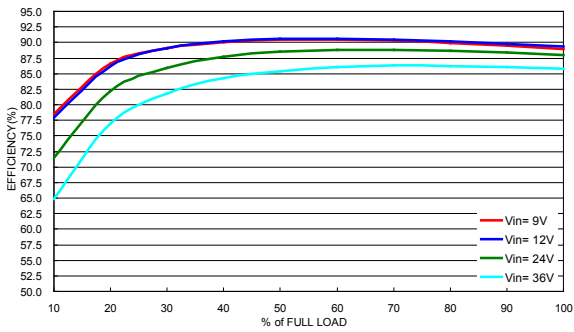

Efficiency versus Output Current

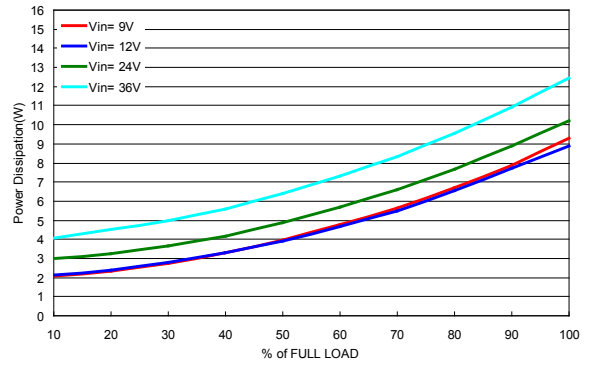

Power Dissipation versus Output Current

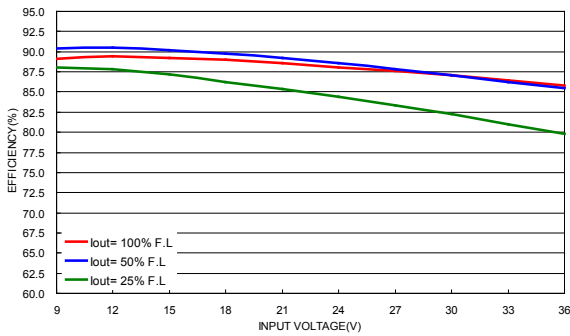

Efficiency versus Input Voltage. Full Load

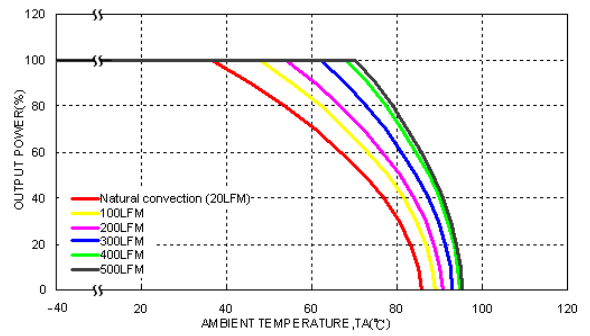

Derating Output Current versus Ambient Temperature with Airflow, Vin = Vin(nom)

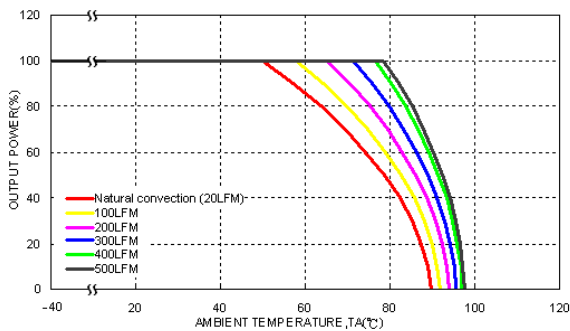

Derating Output Current Versus Ambient Temperature with 0.24" Heat-Sink and Airflow, Vin = Vin(nom)

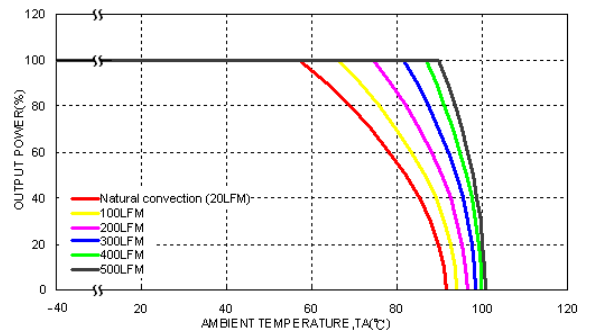

Derating Output Current Versus Ambient Temperature with 0.45" Heat-Sink and Airflow, Vin = Vin(nom)

Characteristic Curves

All test conditions are at 25°C. The figures are identical for TEP 75-2411WI (continued)

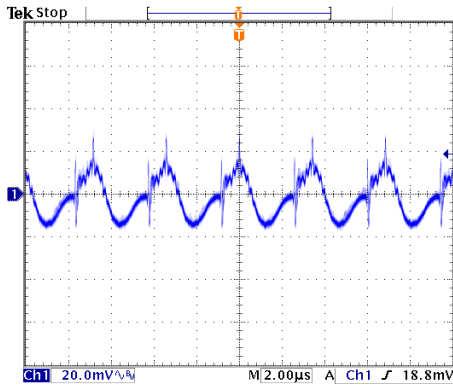

Typical Output Ripple and Noise.
Vin = Vin(nom), Full Load

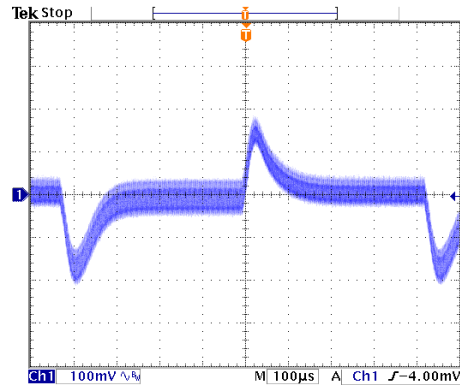

Transient Response to Dynamic Load Change from 100% to 75% to 100% of Full Load , Vin = Vin(nom)

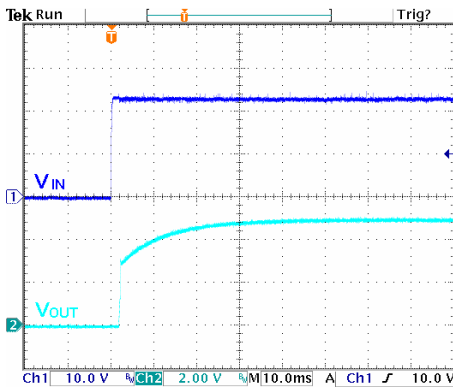

Typical Input Start-Up and Output Rise Characteristic
Vin = Vin(nom), Full Load

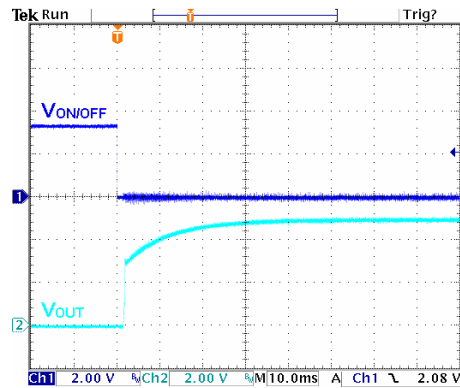

Using ON/OFF Voltage Start-Up and Vo Rise Characteristic
Vin = Vin(nom), Full Load

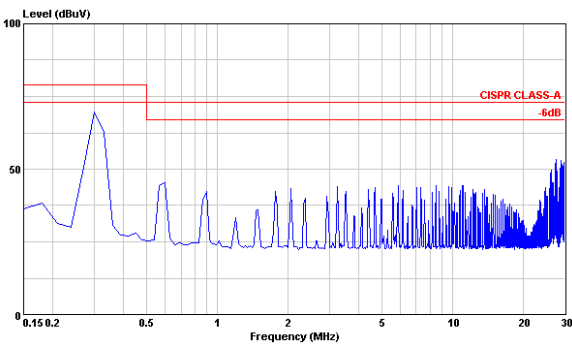

Conduction Emission of EN55022 Class A
Vin = Vin(nom), Full Load

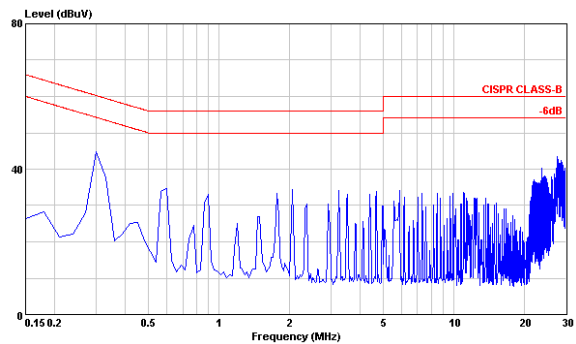

Conduction Emission of EN55022 Class B
Vin = Vin(nom), Full Load

Characteristic Curves

All test conditions are at 25°C. The figures are identical for TEP 75-2412WI

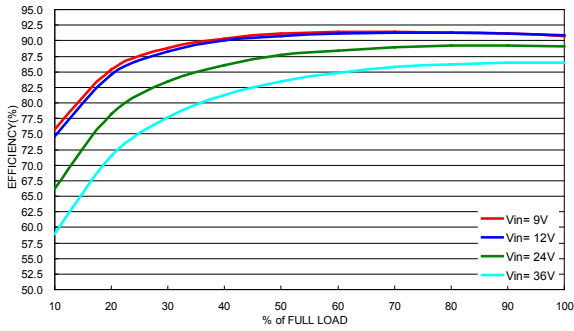

Efficiency versus Output Current

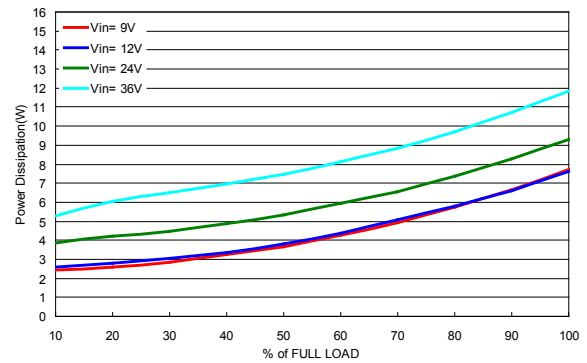

Power Dissipation versus Output Current

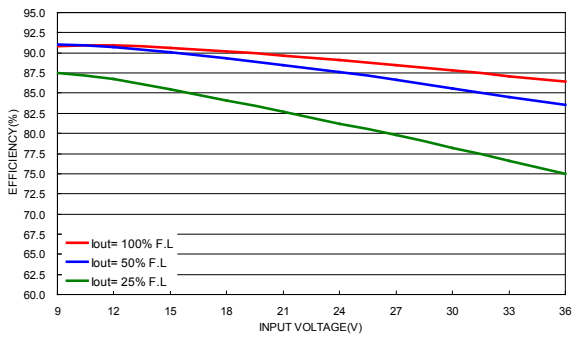

Efficiency versus Input Voltage. Full Load

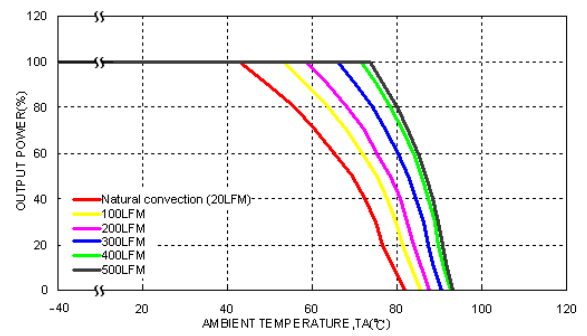

Derating Output Current versus Ambient Temperature with Airflow , Vin = Vin(nom)

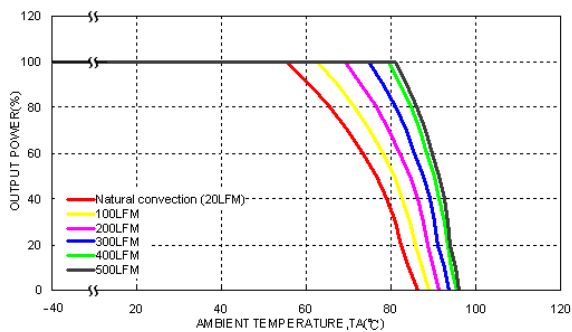

Derating Output Current Versus Ambient Temperature with 0.24" Heat-Sink and Airflow , Vin = Vin(nom)

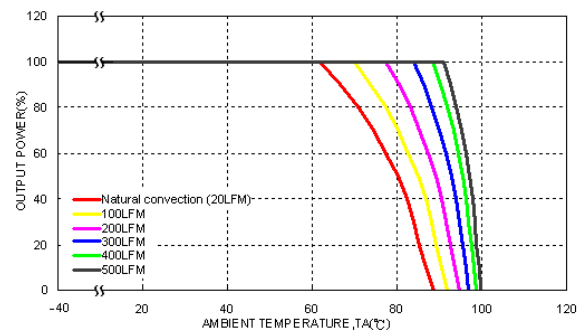

Derating Output Current Versus Ambient Temperature with 0.45" Heat-Sink and Airflow , Vin = Vin(nom)

Characteristic Curves

All test conditions are at 25°C. The figures are identical for TEP 75-2412WI (continued)

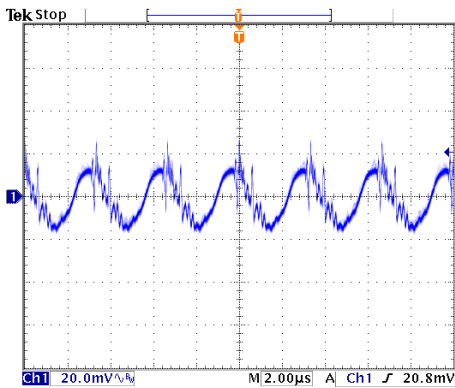

Typical Output Ripple and Noise.
Vin = Vin(nom), Full Load

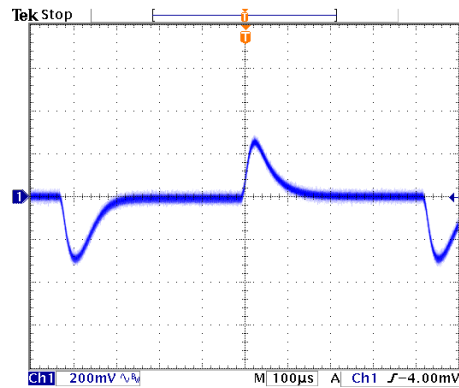

Transient Response to Dynamic Load Change from 100% to 75% to 100% of Full Load , Vin = Vin(nom)

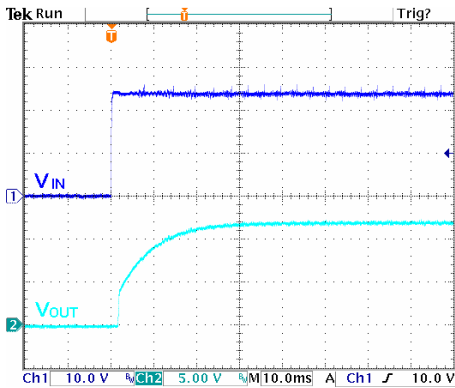

Typical Input Start-Up and Output Rise Characteristic
Vin = Vin(nom), Full Load

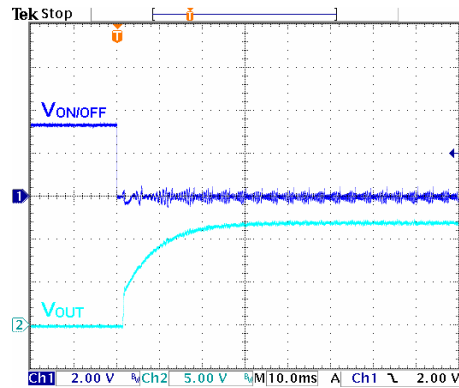

Using ON/OFF Voltage Start-Up and Vo Rise Characteristic
Vin = Vin(nom), Full Load

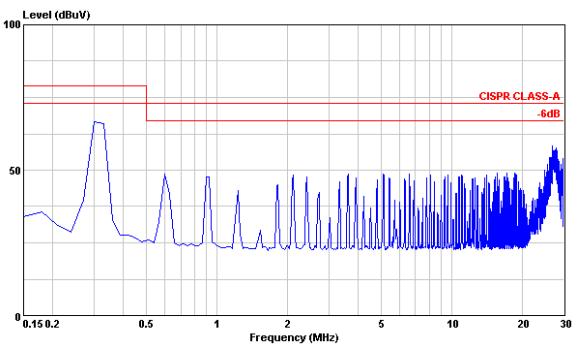

Conduction Emission of EN55022 Class A
Vin = Vin(nom), Full Load

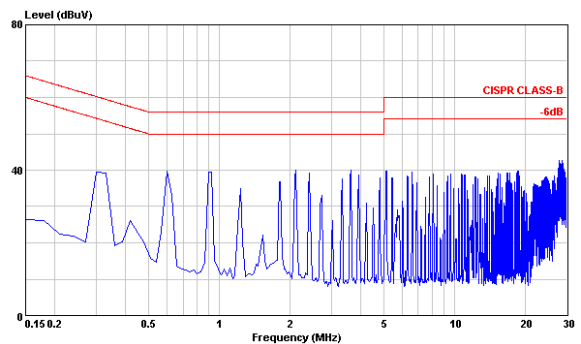

Conduction Emission of EN55022 Class B
Vin = Vin(nom), Full Load

Characteristic Curves

All test conditions are at 25°C. The figures are identical for TEP 75-2413WI

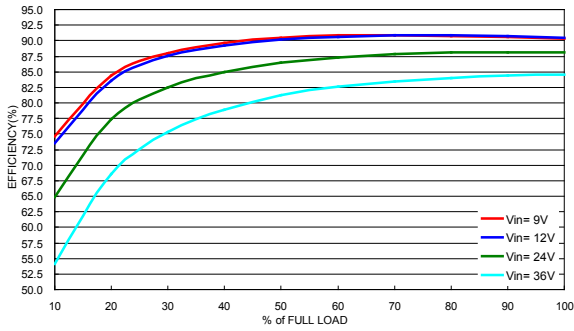

Efficiency versus Output Current

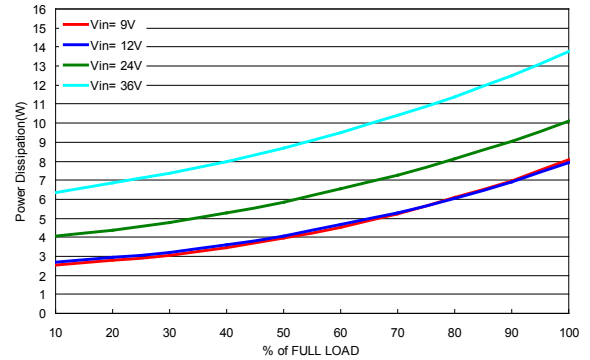

Power Dissipation versus Output Current

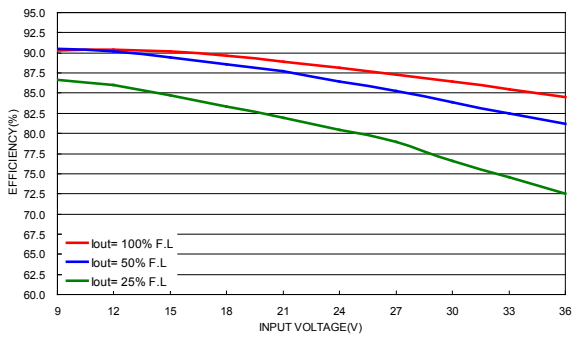

Efficiency versus Input Voltage. Full Load

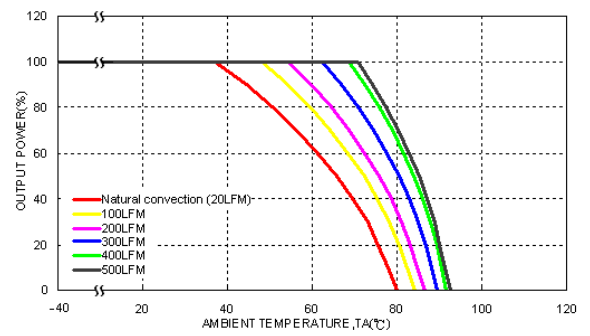

Derating Output Current versus Ambient Temperature with Airflow , Vin = Vin(nom)

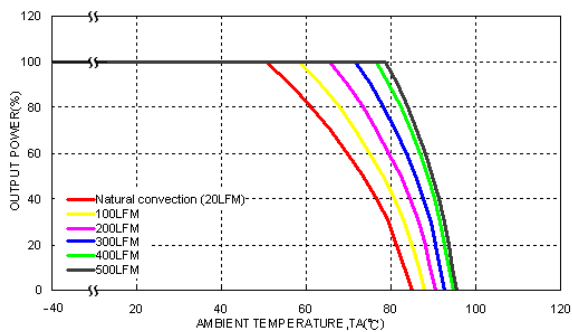

Derating Output Current Versus Ambient Temperature with 0.24" Heat-Sink and Airflow , Vin = Vin(nom)

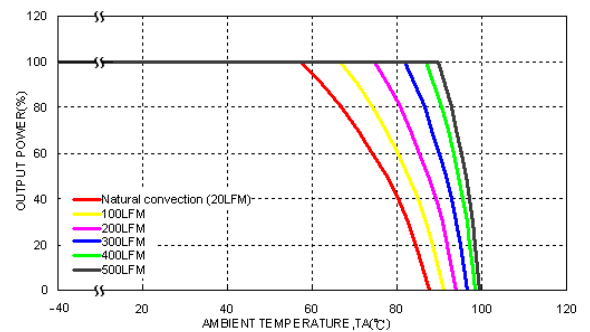

Derating Output Current Versus Ambient Temperature with 0.45" Heat-Sink and Airflow , Vin = Vin(nom)

Characteristic Curves

All test conditions are at 25°C. The figures are identical for TEP 75-2415WI (continued)

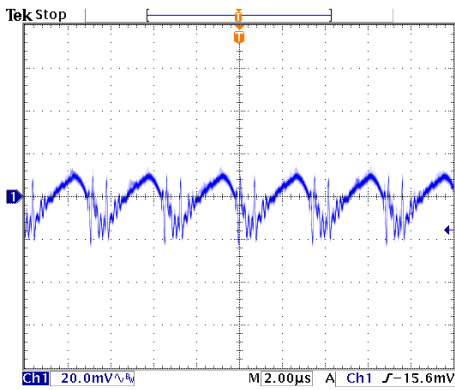

Typical Output Ripple and Noise.
Vin = Vin(nom), Full Load

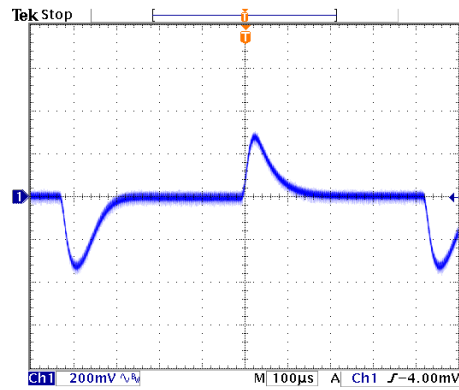

Transient Response to Dynamic Load Change from 100% to 75% to 100% of Full Load , Vin = Vin(nom)

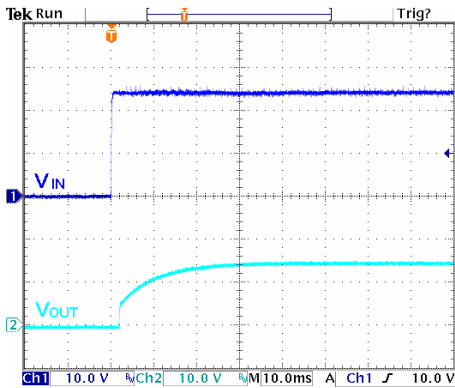

Typical Input Start-Up and Output Rise Characteristic
Vin = Vin(nom), Full Load

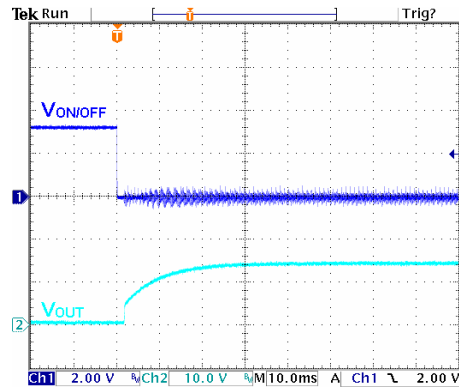

Using ON/OFF Voltage Start-Up and Vo Rise Characteristic
Vin = Vin(nom), Full Load

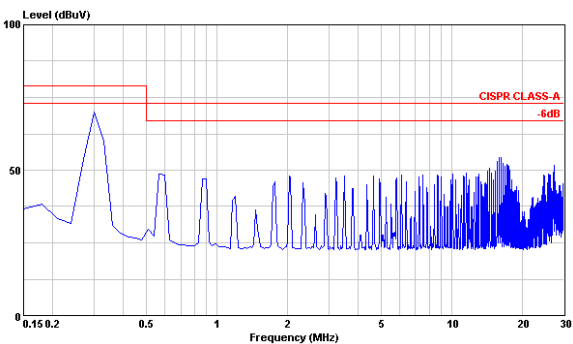

Conduction Emission of EN55022 Class A
Vin = Vin(nom), Full Load

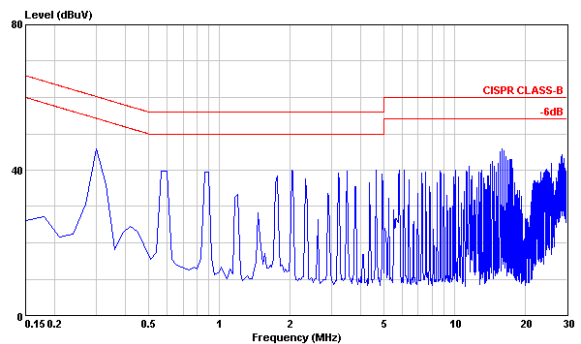

Conduction Emission of EN55022 Class B
Vin = Vin(nom), Full Load

Characteristic Curves

All test conditions are at 25°C. The figures are identical for TEP 75-2415WI

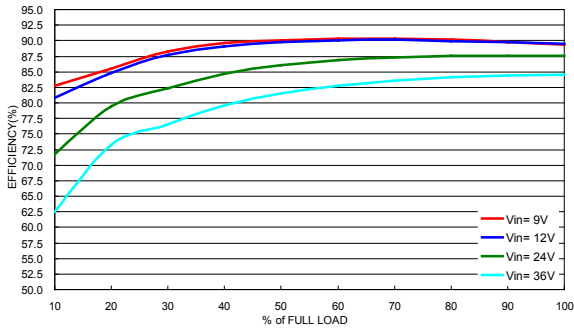

Efficiency versus Output Current

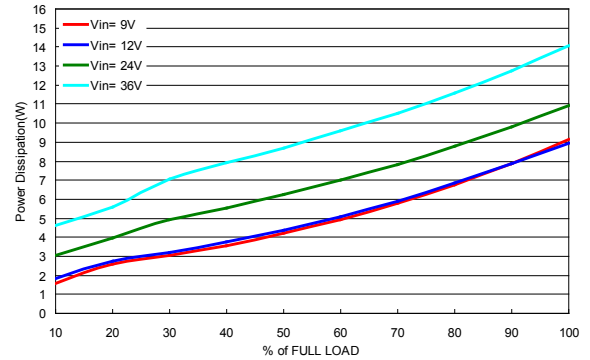

Power Dissipation versus Output Current

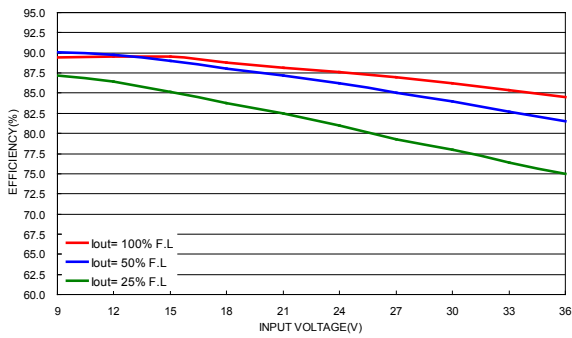

Efficiency versus Input Voltage. Full Load

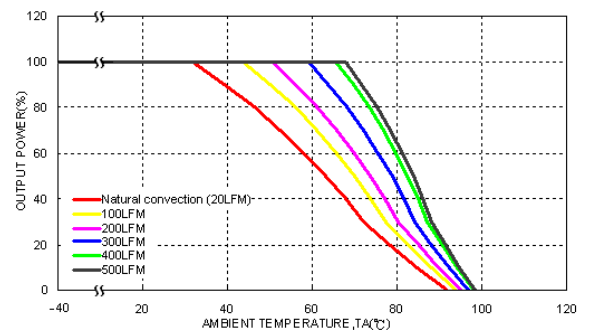

Derating Output Current versus Ambient Temperature with Airflow , Vin = Vin(nom)

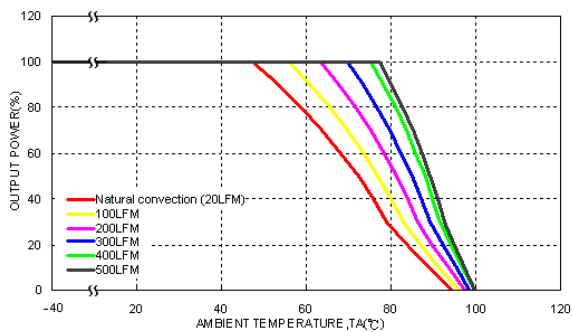

Derating Output Current versus Ambient Temperature with 0.24" Heat-Sink and Airflow , Vin = Vin(nom)

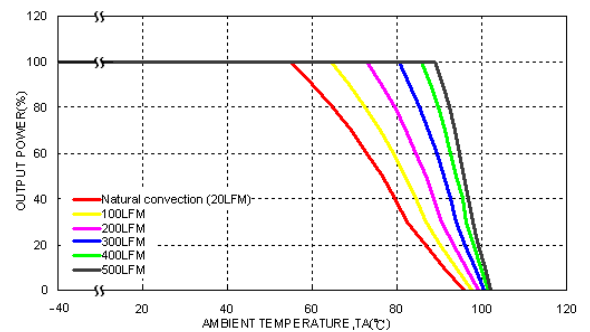

Derating Output Current versus Ambient Temperature with 0.45" Heat-Sink and Airflow , Vin = Vin(nom)

Characteristic Curves

All test conditions are at 25°C. The figures are identical for TEP 75-2415WI (continued)

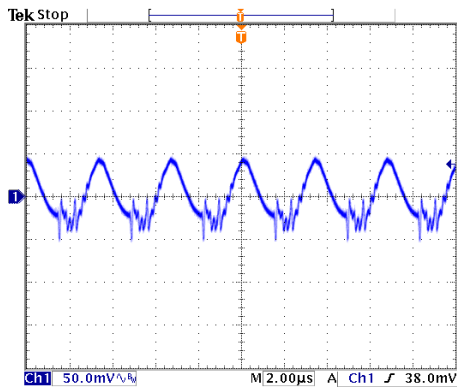

Typical Output Ripple and Noise.
Vin = Vin(nom), Full Load

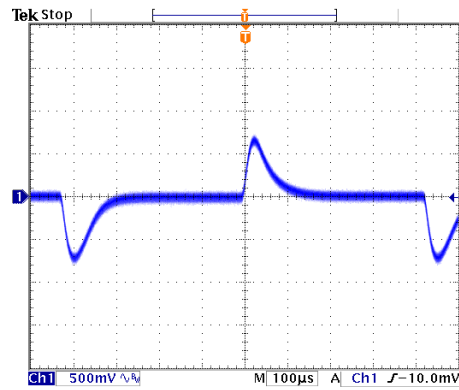

Transient Response to Dynamic Load Change from 100% to 75% to 100% of Full Load , Vin = Vin(nom)

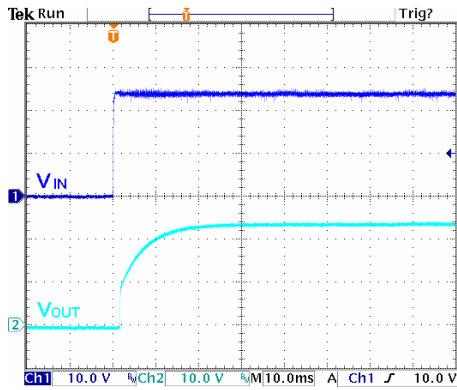

Typical Input Start-Up and Output Rise Characteristic
Vin = Vin(nom), Full Load

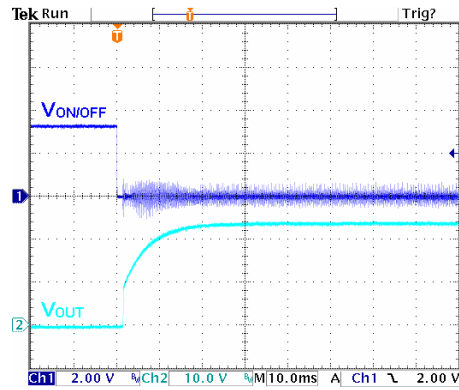

Using ON/OFF Voltage Start-Up and Vo Rise Characteristic
Vin = Vin(nom), Full Load

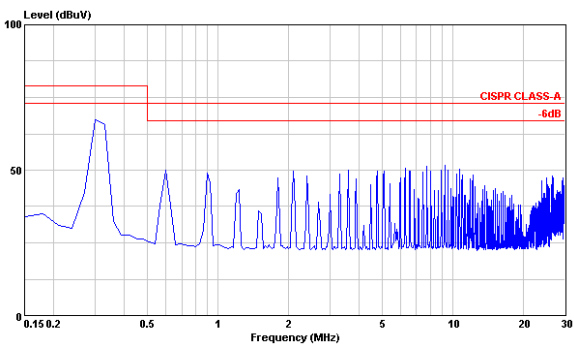

Conduction Emission of EN55022 Class A
Vin = Vin(nom), Full Load

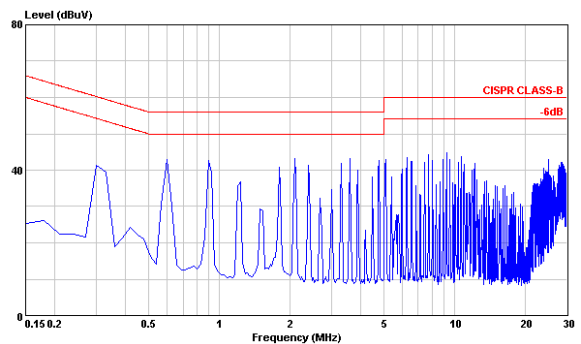

Conduction Emission of EN55022 Class B
Vin = Vin(nom), Full Load

Characteristic Curves

All test conditions are at 25°C. The figures are identical for TEP 75-2416WI

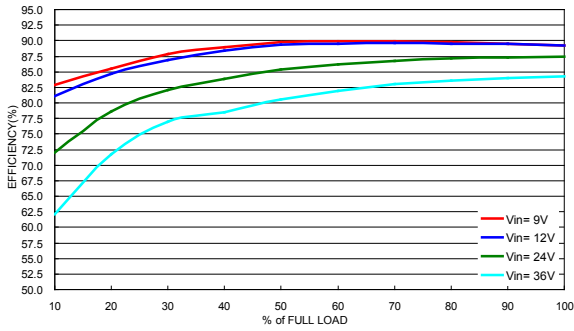

Efficiency versus Output Current

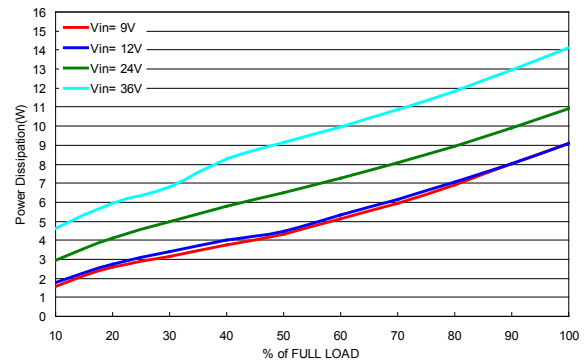

Power Dissipation versus Output Current

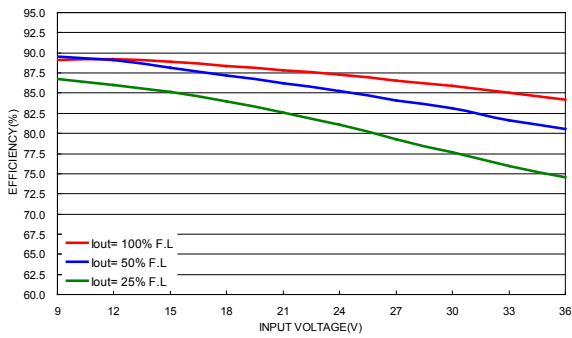

Efficiency versus Input Voltage. Full Load

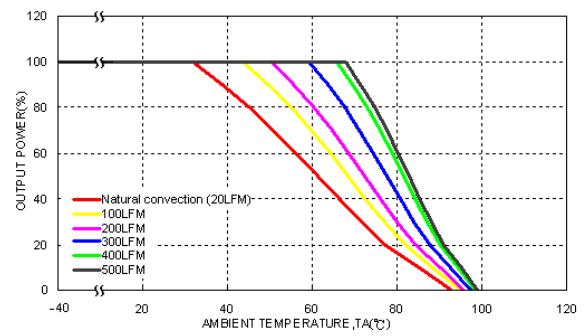

Derating Output Current versus Ambient Temperature with Airflow , Vin = Vin(nom)

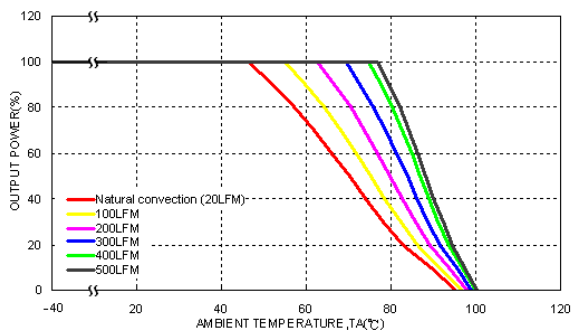

Derating Output Current Versus Ambient Temperature with 0.24" Heat-Sink and Airflow , Vin = Vin(nom)

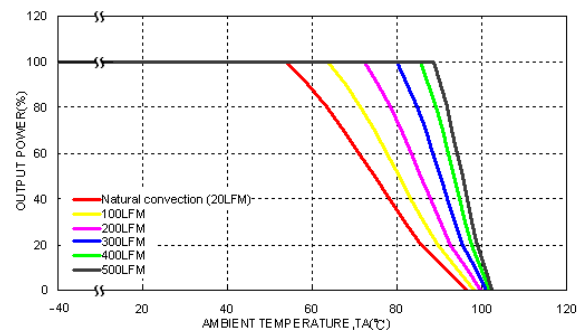

Derating Output Current Versus Ambient Temperature with 0.45" Heat-Sink and Airflow , Vin = Vin(nom)

Characteristic Curves

All test conditions are at 25°C. The figures are identical for TEP 75-2416WI (continued)

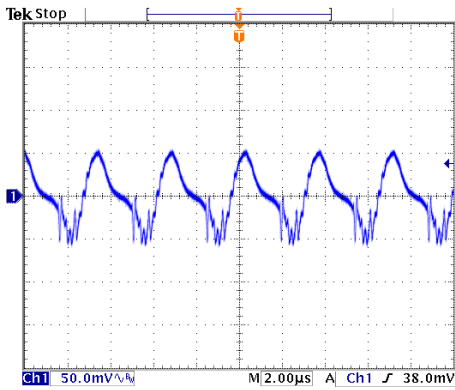

Typical Output Ripple and Noise.
Vin = Vin(nom), Full Load

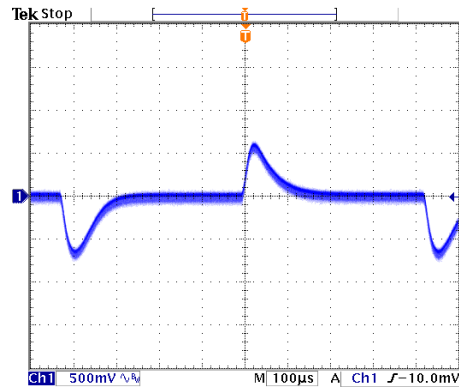

Transient Response to Dynamic Load Change from 100% to 75% to 100% of Full Load , Vin = Vin(nom)

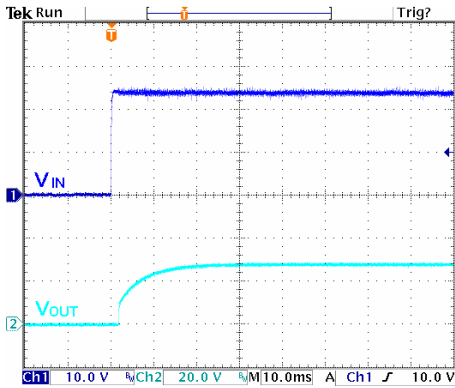

Typical Input Start-Up and Output Rise Characteristic
Vin = Vin(nom), Full Load

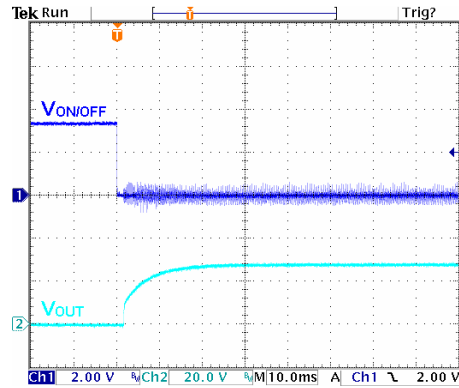

Using ON/OFF Voltage Start-Up and Vo Rise Characteristic
Vin = Vin(nom), Full Load

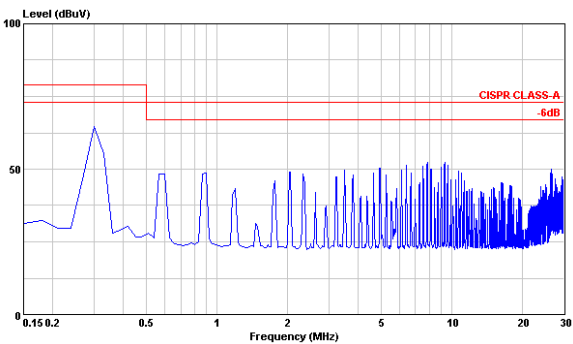

Conduction Emission of EN55022 Class A
Vin = Vin(nom), Full Load

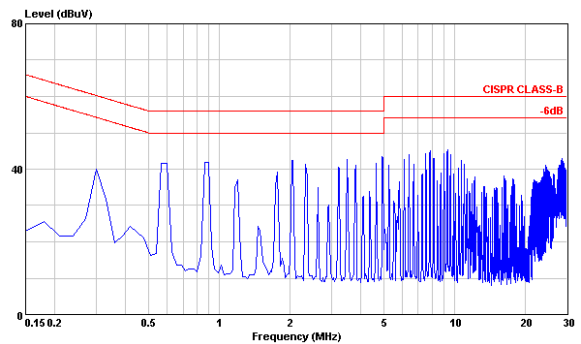

Conduction Emission of EN55022 Class B
Vin = Vin(nom), Full Load

Characteristic Curves

All test conditions are at 25°C. The figures are identical for TEP 75-2418WI

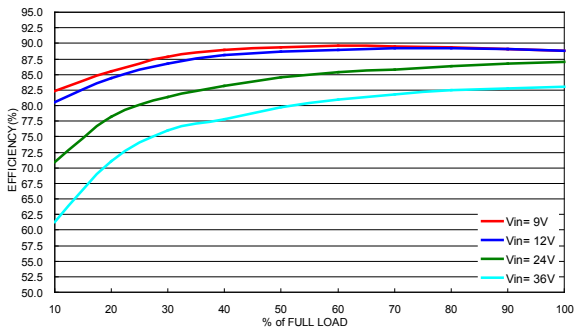

Efficiency versus Output Current

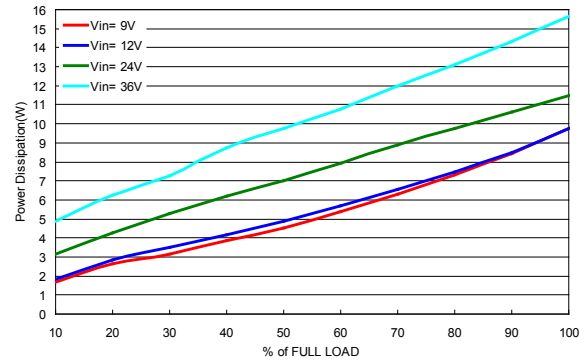

Power Dissipation versus Output Current

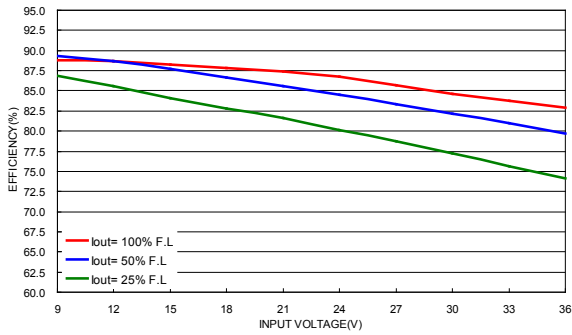

Efficiency versus Input Voltage. Full Load

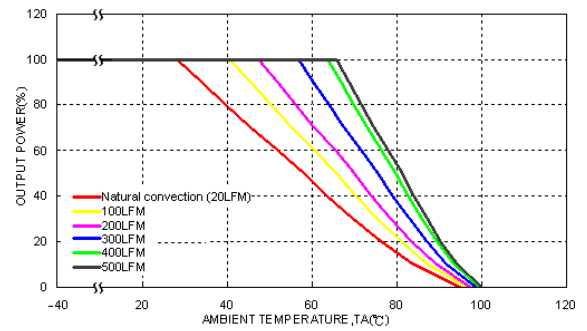

Derating Output Current versus Ambient Temperature with Airflow , Vin = Vin(nom)

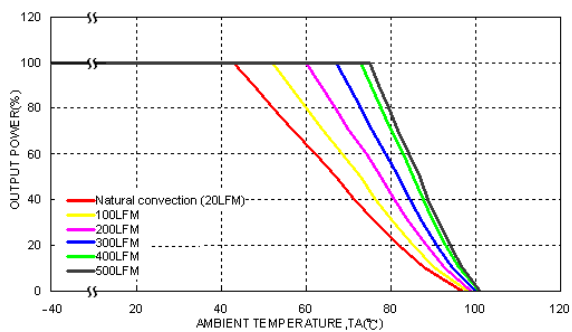

Derating Output Current versus Ambient Temperature with 0.24" Heat-Sink and Airflow , Vin = Vin(nom)

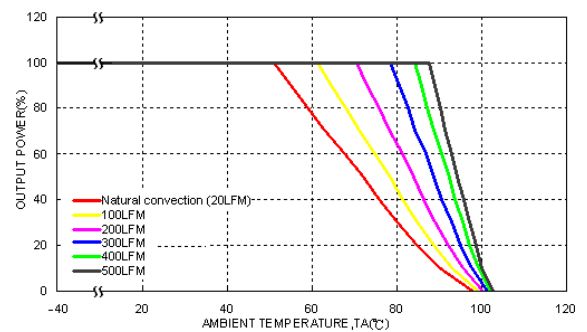

Derating Output Current versus Ambient Temperature with 0.45" Heat-Sink and Airflow , Vin = Vin(nom)

Characteristic Curves

All test conditions are at 25°C. The figures are identical for TEP 75-2418WI (continued)

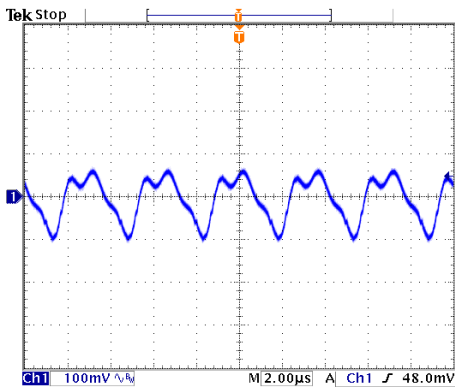

Typical Output Ripple and Noise.
Vin = Vin(nom), Full Load

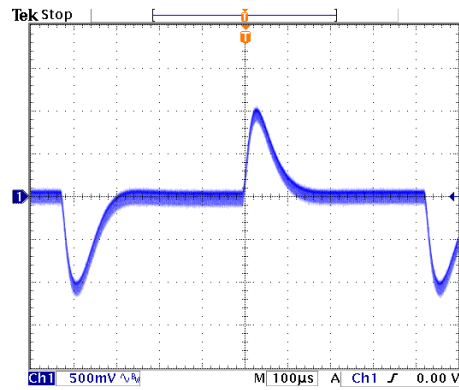

Transient Response to Dynamic Load Change from 100% to 75% to 100% of Full Load , Vin = Vin(nom)

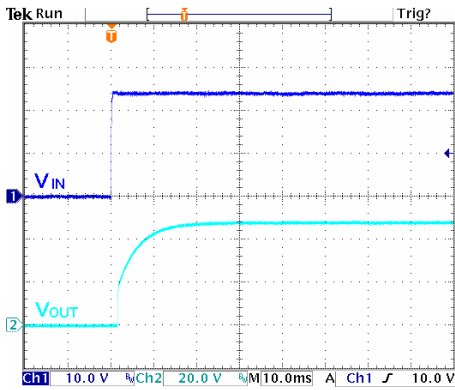

Typical Input Start-Up and Output Rise Characteristic
Vin = Vin(nom), Full Load

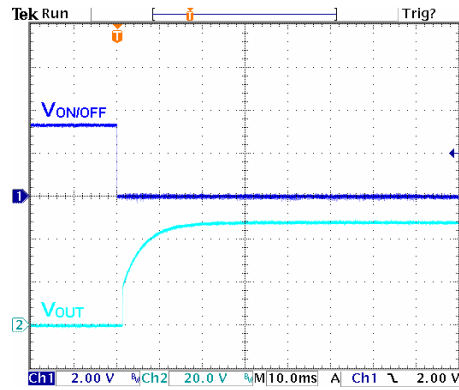

Using ON/OFF Voltage Start-Up and Vo Rise Characteristic
Vin = Vin(nom), Full Load

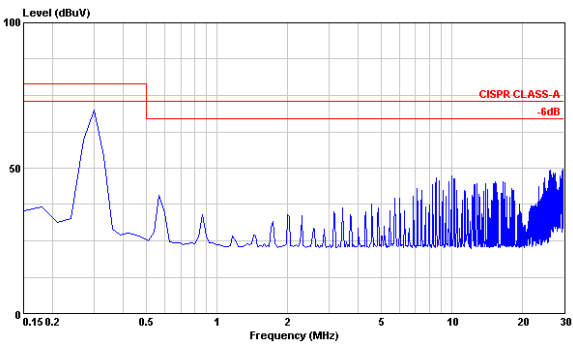

Conduction Emission of EN55022 Class A
Vin = Vin(nom), Full Load

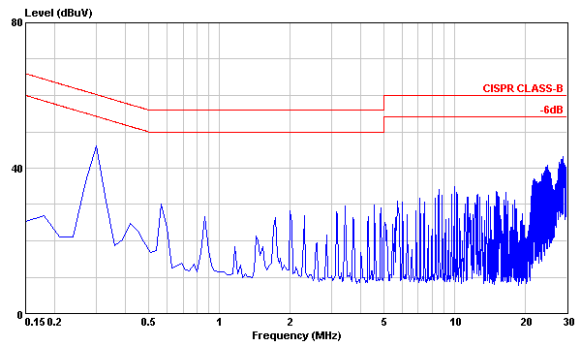

Conduction Emission of EN55022 Class B
Vin = Vin(nom), Full Load

Characteristic Curves

All test conditions are at 25°C. The figures are identical for TEP 75-4810WI

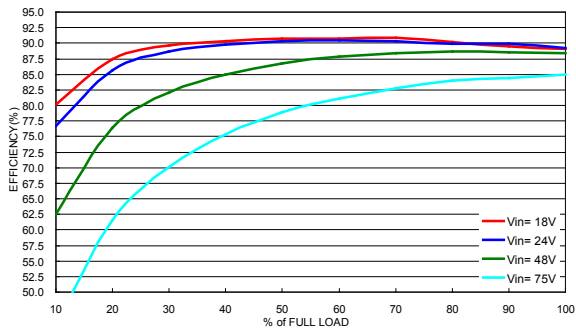

Efficiency versus Output Current

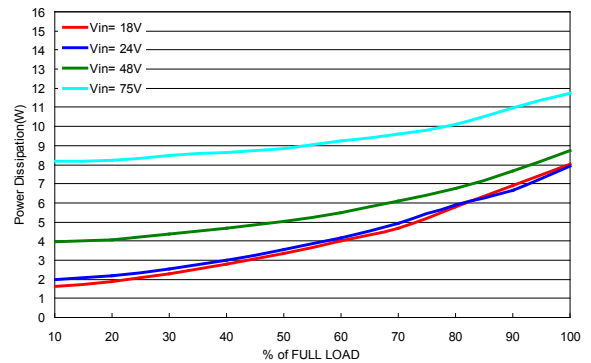

Power Dissipation versus Output Current

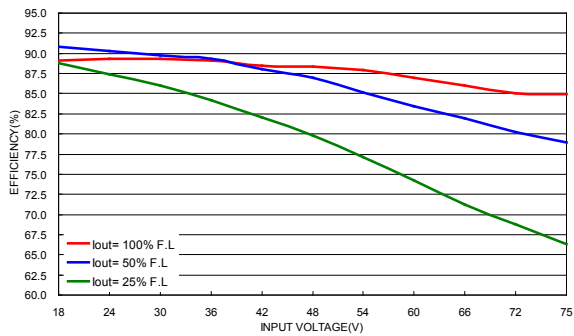

Efficiency versus Input Voltage. Full Load

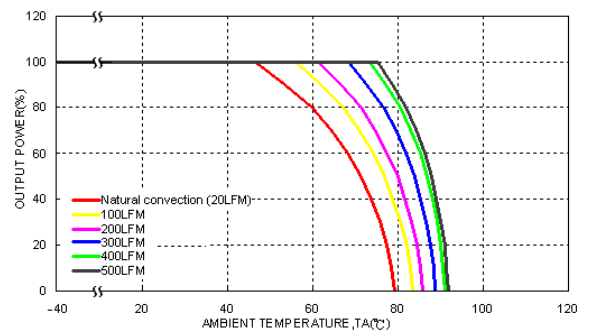

Derating Output Current versus Ambient Temperature with Airflow , Vin = Vin(nom)

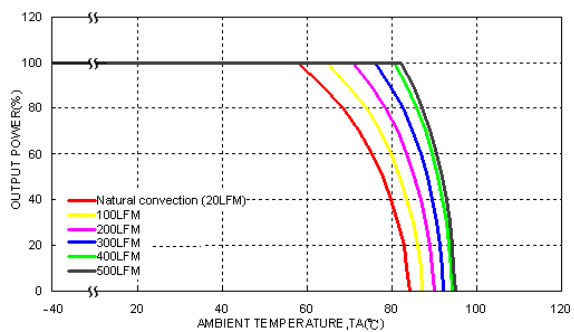

Derating Output Current Versus Ambient Temperature with 0.24'' Heat-Sink and Airflow , Vin = Vin(nom)

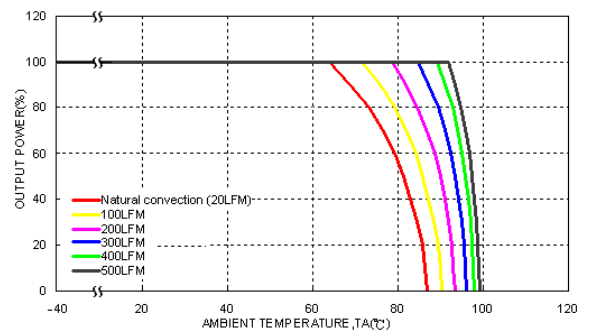

Derating Output Current Versus Ambient Temperature with 0.45'' Heat-Sink and Airflow , Vin = Vin(nom)

Characteristic Curves

All test conditions are at 25°C. The figures are identical for TEP 75-4810WI (continued)

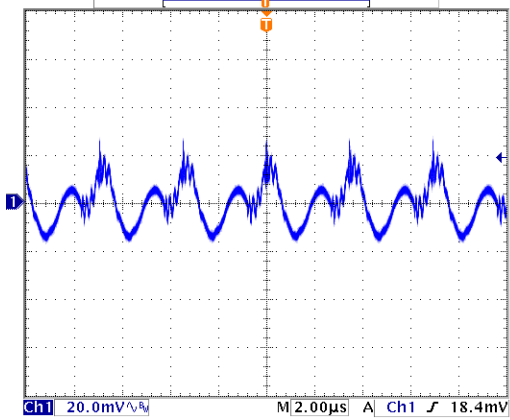

Typical Output Ripple and Noise.
Vin = Vin(nom), Full Load

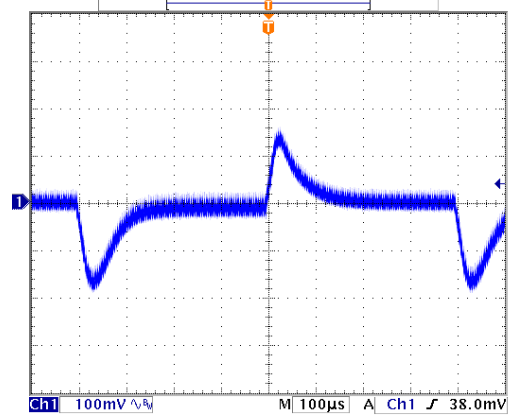

Transient Response to Dynamic Load Change from 100% to 75% to 100% of Full Load , Vin = Vin(nom)

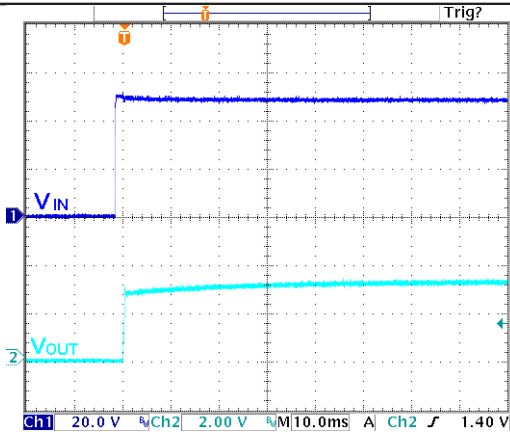

Typical Input Start-Up and Output Rise Characteristic
Vin = Vin(nom), Full Load

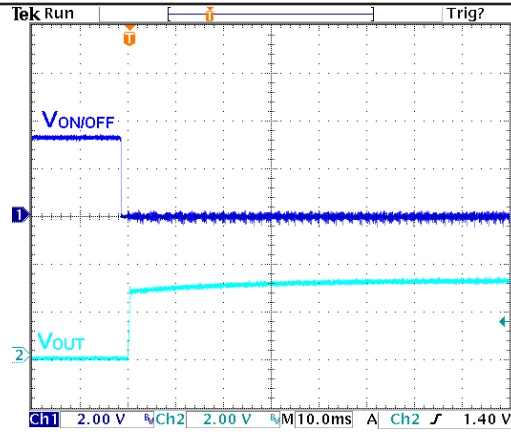

Using ON/OFF Voltage Start-Up and Vo Rise Characteristic
Vin = Vin(nom), Full Load

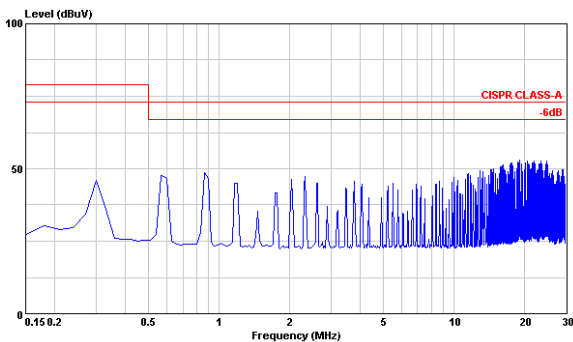

Conduction Emission of EN55022 Class A
Vin = Vin(nom), Full Load

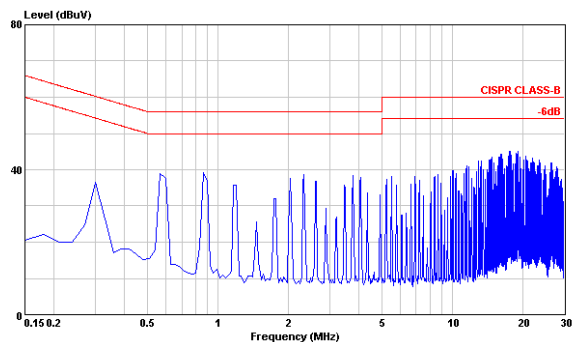

Conduction Emission of EN55022 Class B
Vin = Vin(nom), Full Load

Characteristic Curves

All test conditions are at 25°C. The figures are identical for TEP 75-4811WI

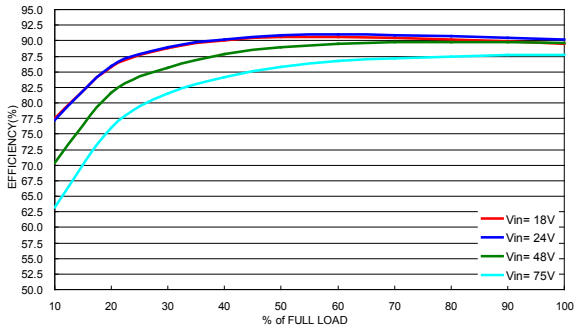

Efficiency versus Output Current

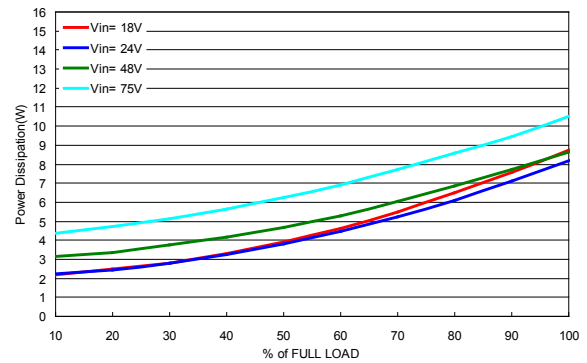

Power Dissipation versus Output Current

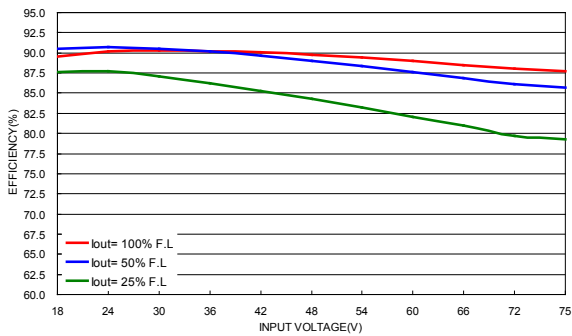

Efficiency versus Input Voltage. Full Load

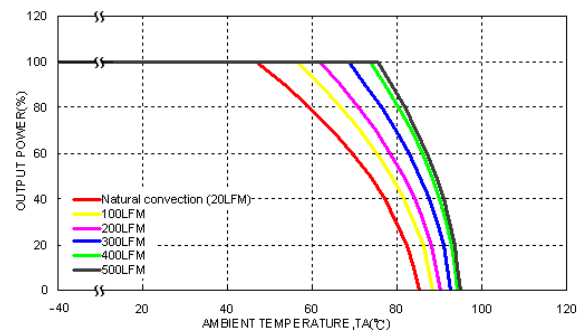

Derating Output Current versus Ambient Temperature with Airflow , Vin = Vin(nom)

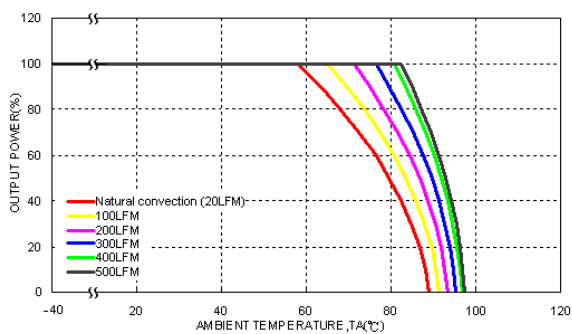

Derating Output Current Versus Ambient Temperature with 0.24'' Heat-Sink and Airflow , Vin = Vin(nom)

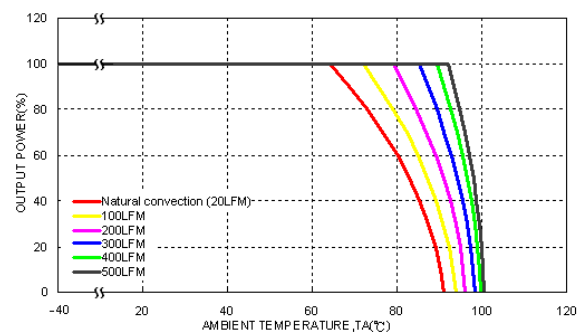

Derating Output Current Versus Ambient Temperature with 0.45'' Heat-Sink and Airflow , Vin = Vin(nom)

Characteristic Curves

All test conditions are at 25°C. The figures are identical for TEP 75-4811WI (continued)

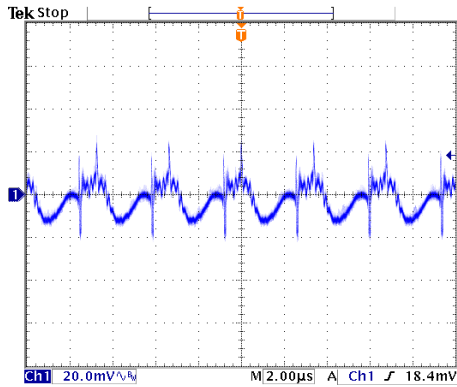

Typical Output Ripple and Noise.
Vin = Vin(nom), Full Load

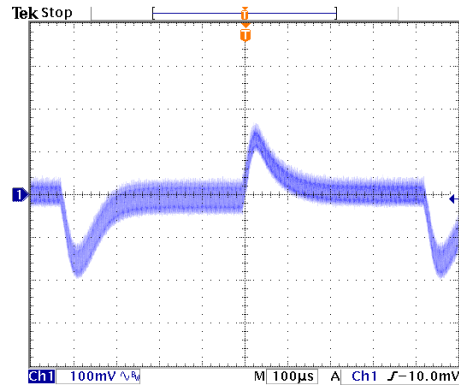

Transient Response to Dynamic Load Change from 100% to 75% to 100% of Full Load , Vin = Vin(nom)

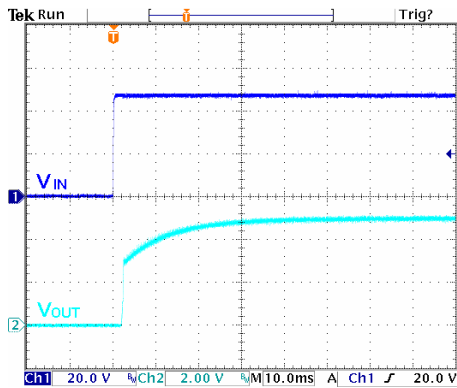

Typical Input Start-Up and Output Rise Characteristic
Vin = Vin(nom), Full Load

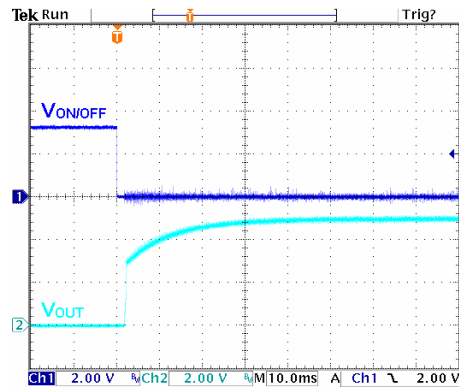

Using ON/OFF Voltage Start-Up and Vo Rise Characteristic
Vin = Vin(nom), Full Load

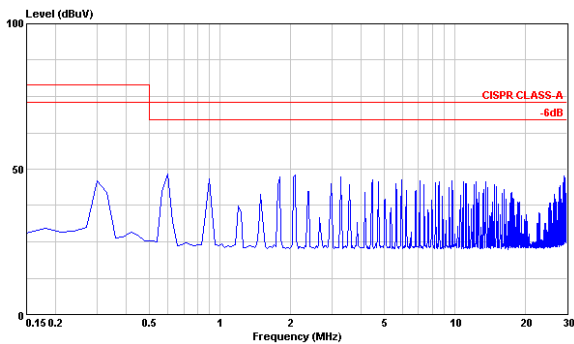

Conduction Emission of EN55022 Class A
Vin = Vin(nom), Full Load

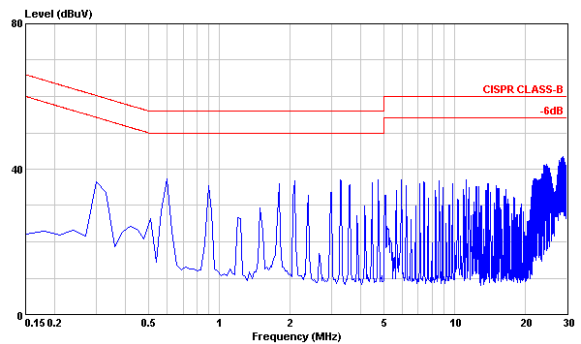

Conduction Emission of EN55022 Class B
Vin = Vin(nom), Full Load

Characteristic Curves

All test conditions are at 25°C. The figures are identical for TEP 75-4812WI

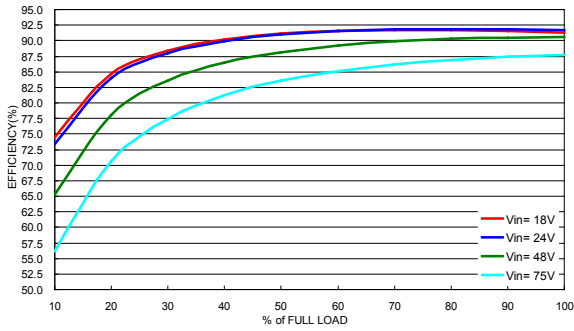

Efficiency versus Output Current

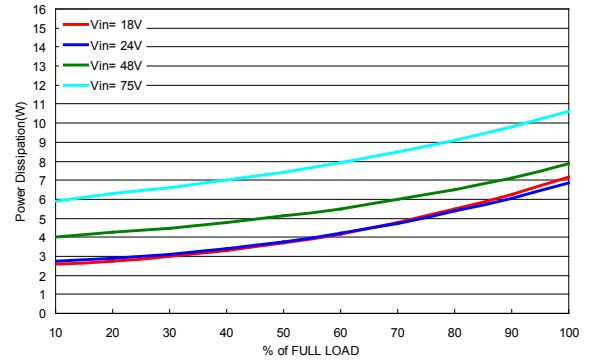

Power Dissipation versus Output Current

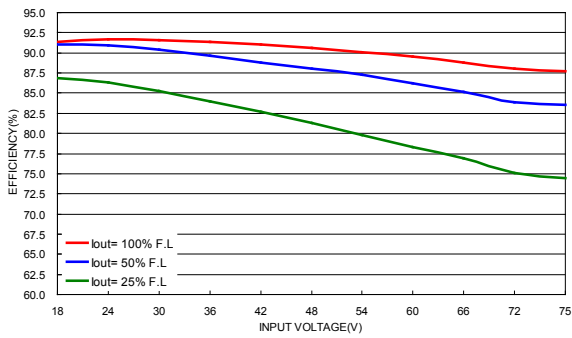

Efficiency versus Input Voltage. Full Load

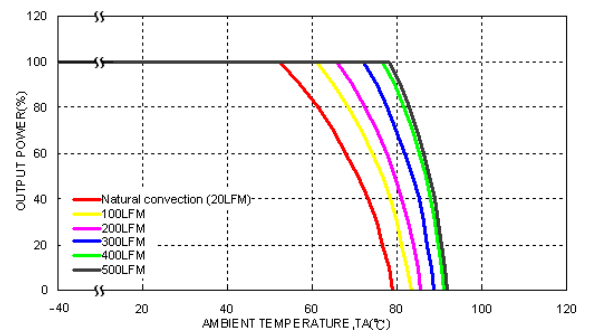

Derating Output Current versus Ambient Temperature with Airflow , Vin = Vin(nom)

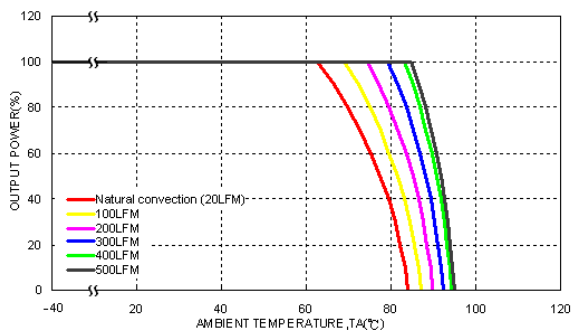

Derating Output Current Versus Ambient Temperature with 0.24'' Heat-Sink and Airflow , Vin = Vin(nom)

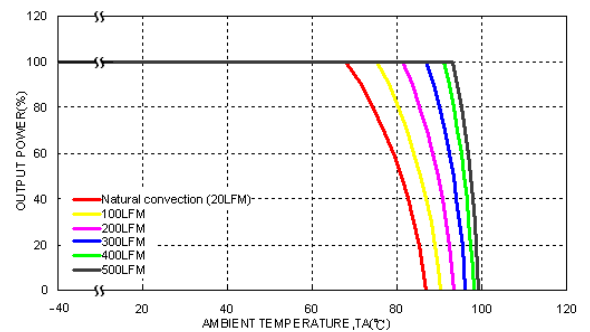

Derating Output Current Versus Ambient Temperature with 0.45'' Heat-Sink and Airflow , Vin = Vin(nom)

Characteristic Curves

All test conditions are at 25°C. The figures are identical for TEP 75-4812WI (continued)

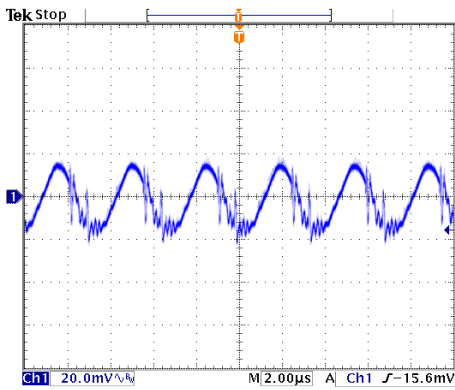

Typical Output Ripple and Noise.
Vin = Vin(nom), Full Load

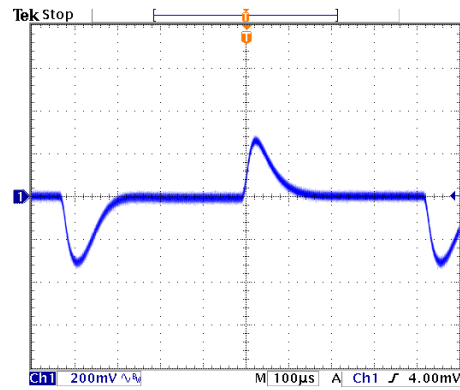

Transient Response to Dynamic Load Change from 100% to 75% to 100% of Full Load , Vin = Vin(nom)

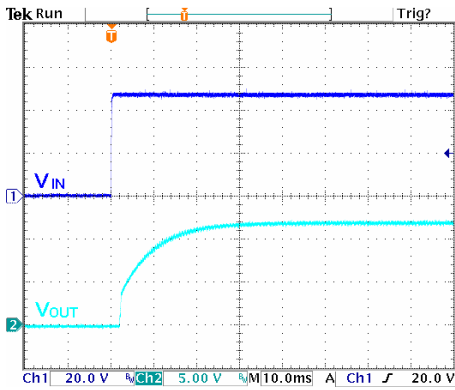

Typical Input Start-Up and Output Rise Characteristic
Vin = Vin(nom), Full Load

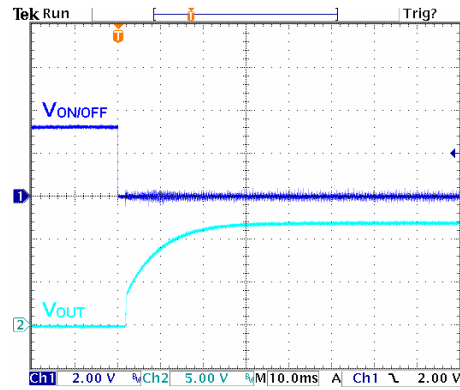

Using ON/OFF Voltage Start-Up and Vo Rise Characteristic
Vin = Vin(nom), Full Load

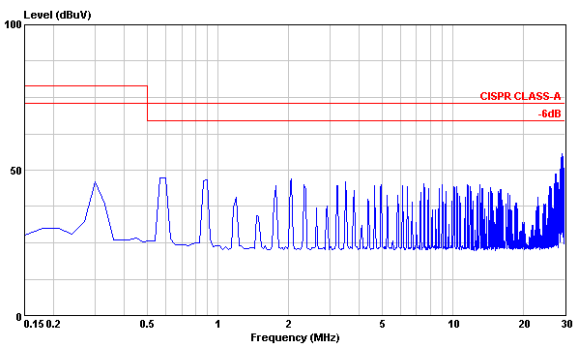

Conduction Emission of EN55022 Class A
Vin = Vin(nom), Full Load

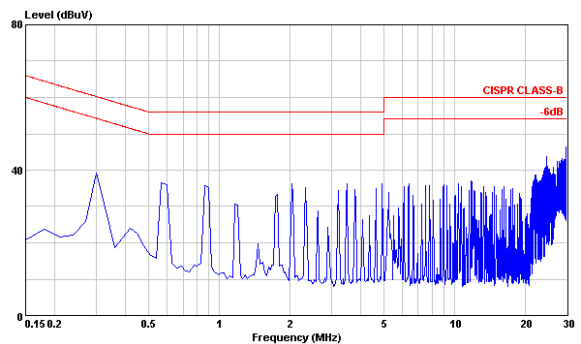

Conduction Emission of EN55022 Class B
Vin = Vin(nom), Full Load

Characteristic Curves

All test conditions are at 25°C. The figures are identical for TEP 75-4813WI

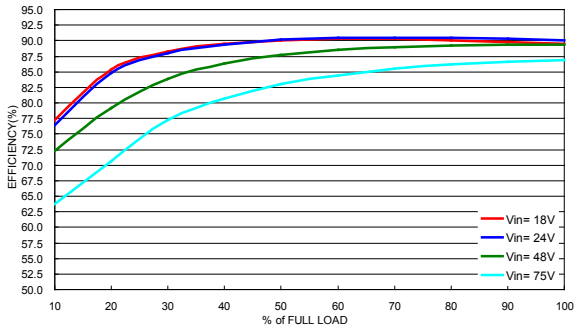

Efficiency versus Output Current

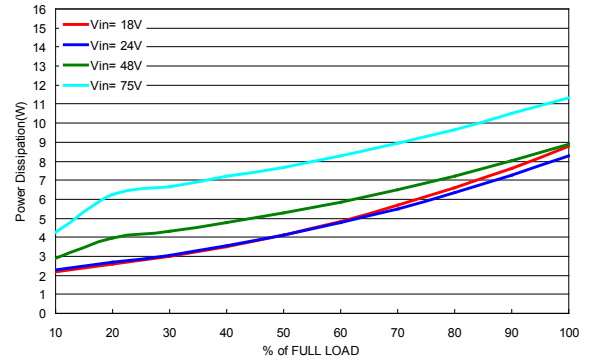

Power Dissipation versus Output Current

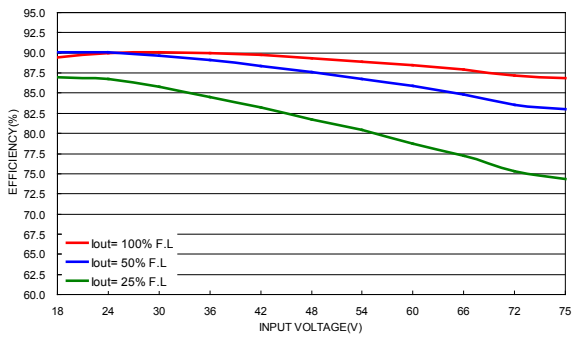

Efficiency versus Input Voltage. Full Load

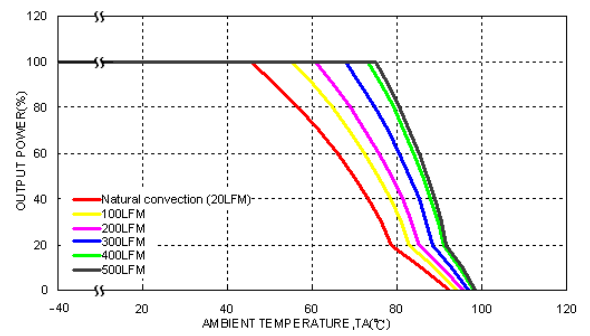

Derating Output Current versus Ambient Temperature with Airflow , Vin = Vin(nom)

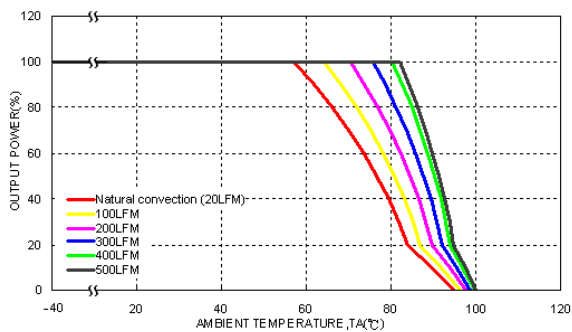

Derating Output Current versus Ambient Temperature with 0.24" Heat-Sink and Airflow , Vin = Vin(nom)

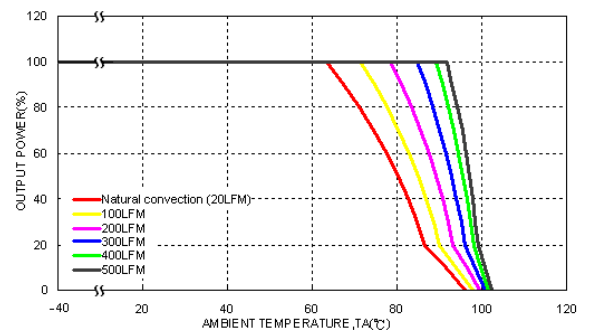

Derating Output Current versus Ambient Temperature with 0.45" Heat-Sink and Airflow , Vin = Vin(nom)

Characteristic Curves

All test conditions are at 25°C. The figures are identical for TEP 75-4813WI (continued)

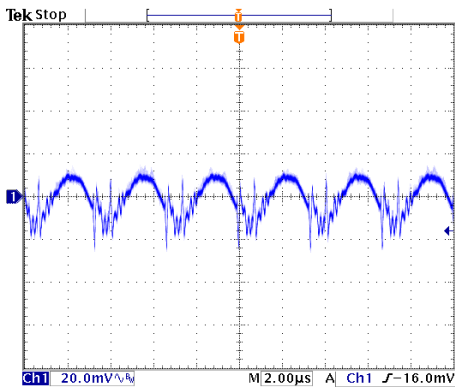

Typical Output Ripple and Noise.
Vin = Vin(nom), Full Load

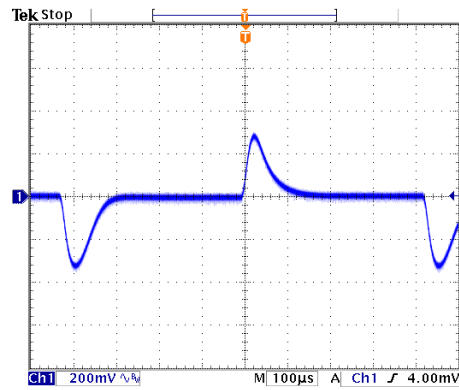

Transient Response to Dynamic Load Change from 100% to 75% to 100% of Full Load , Vin = Vin(nom)

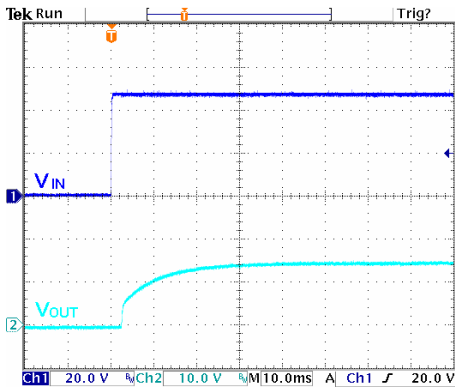

Typical Input Start-Up and Output Rise Characteristic
Vin = Vin(nom), Full Load

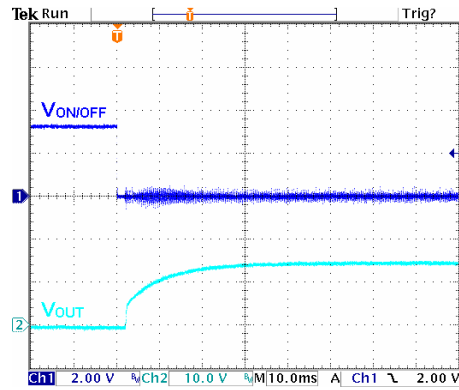

Using ON/OFF Voltage Start-Up and Vo Rise Characteristic
Vin = Vin(nom), Full Load

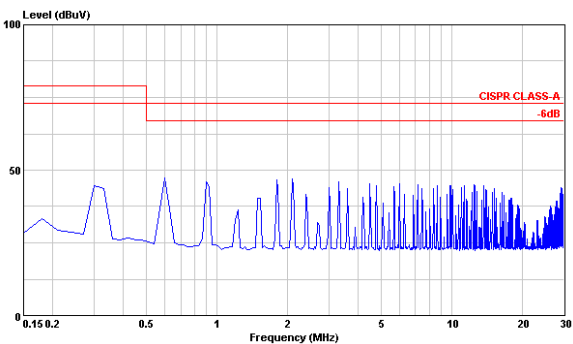

Conduction Emission of EN55022 Class A
Vin = Vin(nom), Full Load

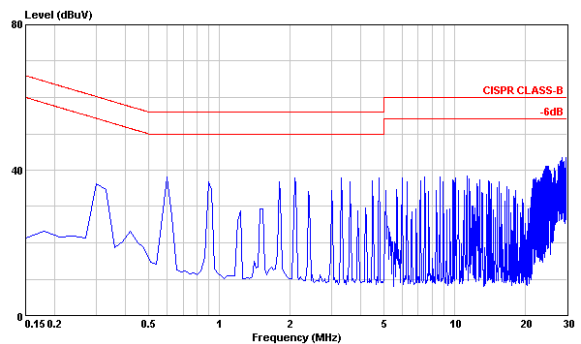

Conduction Emission of EN55022 Class B
Vin = Vin(nom), Full Load

Characteristic Curves

All test conditions are at 25°C. The figures are identical for TEP 75-4815WI

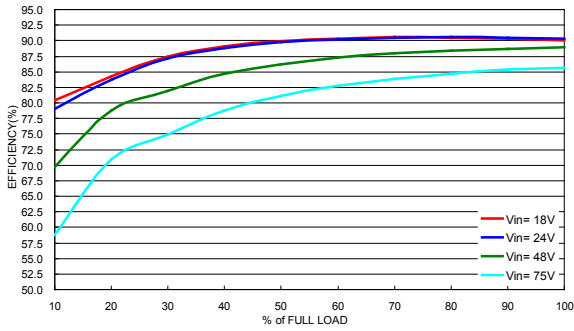

Efficiency versus Output Current

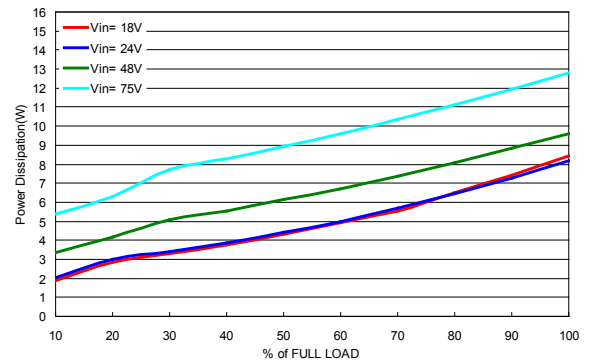

Power Dissipation versus Output Current

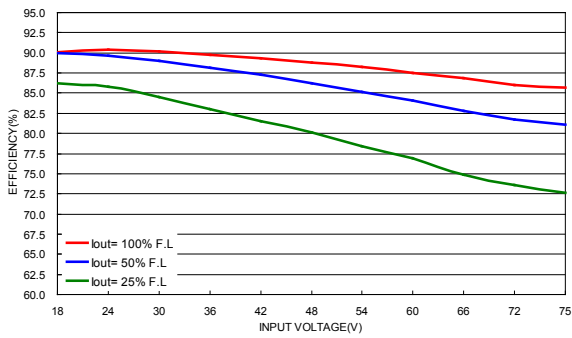

Efficiency versus Input Voltage. Full Load

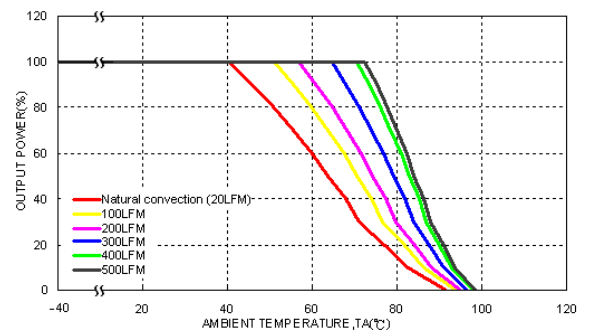

Derating Output Current versus Ambient Temperature with Airflow , Vin = Vin(nom)

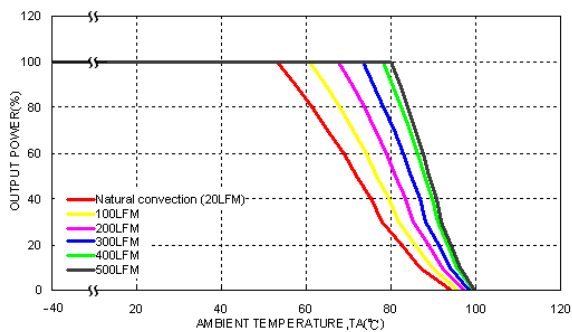

Derating Output Current Versus Ambient Temperature with 0.24'' Heat-Sink and Airflow , Vin = Vin(nom)

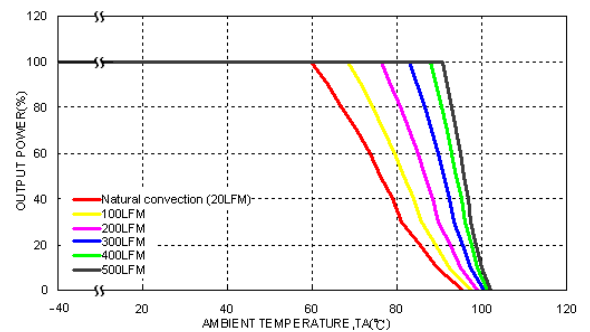

Derating Output Current Versus Ambient Temperature with 0.45'' Heat-Sink and Airflow , Vin = Vin(nom)

Characteristic Curves

All test conditions are at 25°C. The figures are identical for TEP 75-4815WI (continued)

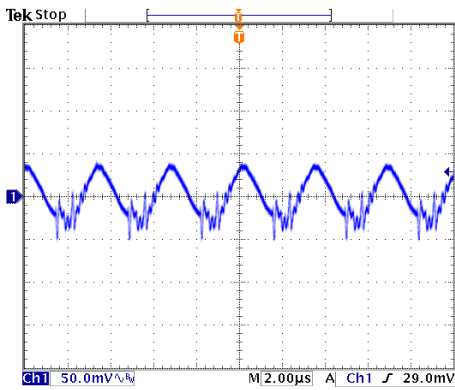

Typical Output Ripple and Noise.
Vin = Vin(nom), Full Load

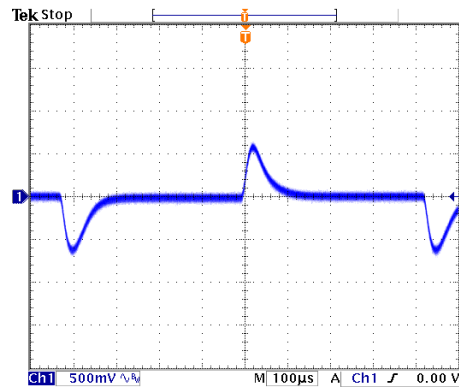

Transient Response to Dynamic Load Change from 100% to 75% to 100% of Full Load , Vin = Vin(nom)

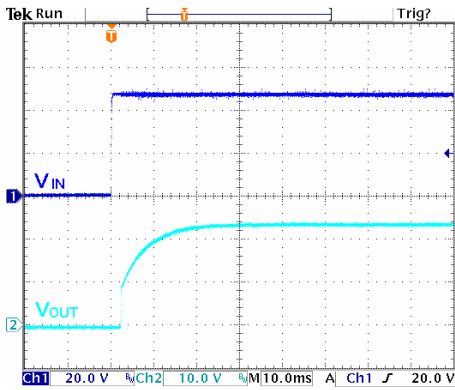

Typical Input Start-Up and Output Rise Characteristic
Vin = Vin(nom), Full Load

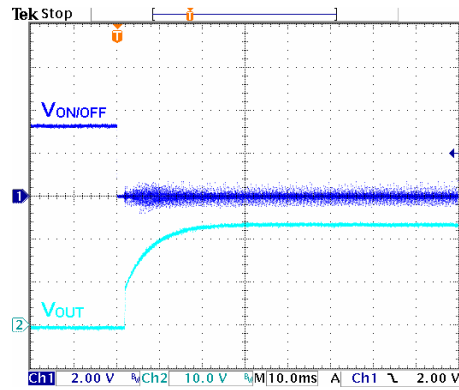

Using ON/OFF Voltage Start-Up and Vo Rise Characteristic
Vin = Vin(nom), Full Load

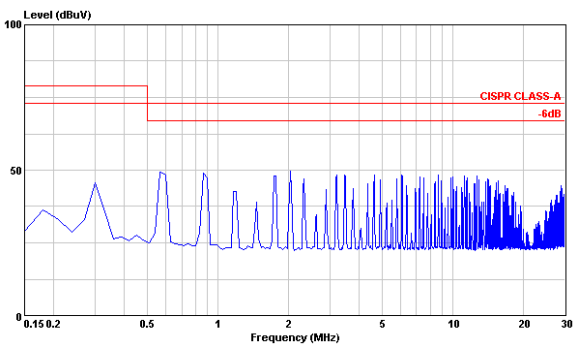

Conduction Emission of EN55022 Class A
Vin = Vin(nom), Full Load

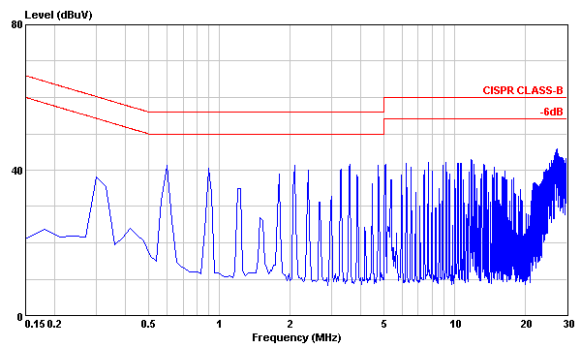

Conduction Emission of EN55022 Class B
Vin = Vin(nom), Full Load

Characteristic Curves

All test conditions are at 25°C. The figures are identical for TEP 75-4816WI

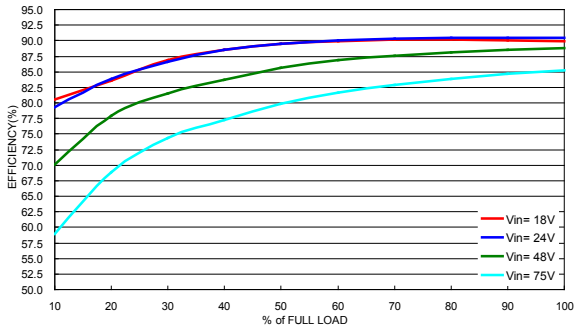

Efficiency versus Output Current

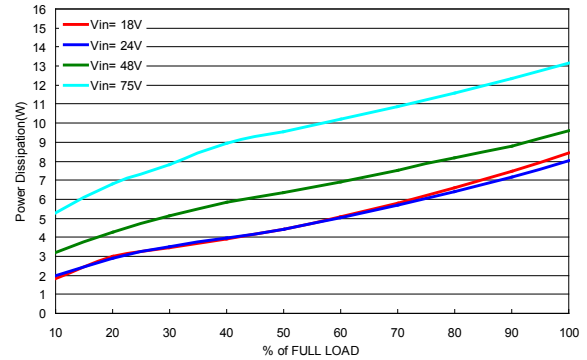

Power Dissipation versus Output Current

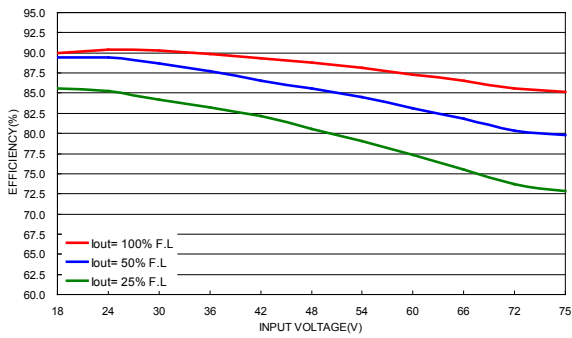

Efficiency versus Input Voltage. Full Load

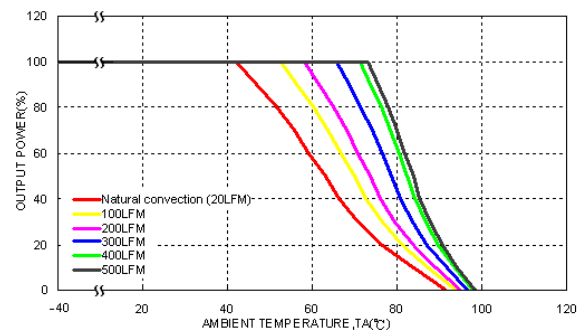

Derating Output Current versus Ambient Temperature with Airflow , Vin = Vin(nom)

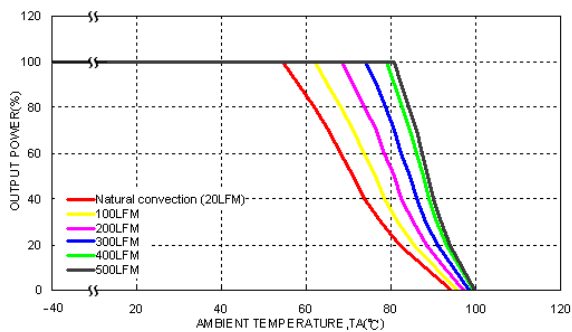

Derating Output Current Versus Ambient Temperature with 0.24'' Heat-Sink and Airflow , Vin = Vin(nom)

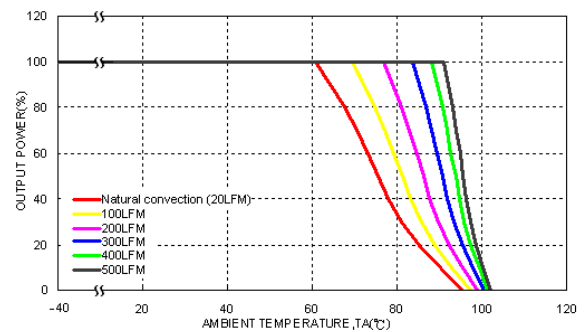

Derating Output Current Versus Ambient Temperature with 0.45'' Heat-Sink and Airflow , Vin = Vin(nom)

Characteristic Curves

All test conditions are at 25°C. The figures are identical for TEP 75-4816WI (continued)

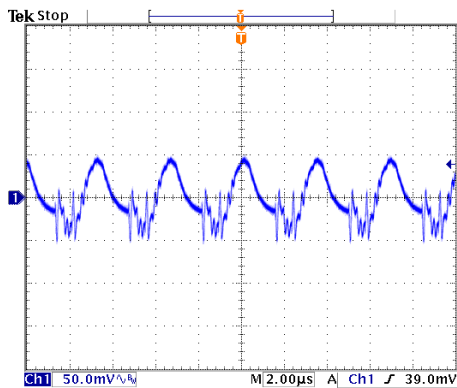

Typical Output Ripple and Noise.
Vin = Vin(nom), Full Load

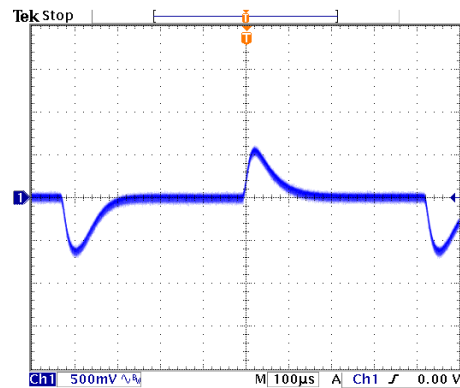

Transient Response to Dynamic Load Change from 100% to 75% to 100% of Full Load , Vin = Vin(nom)

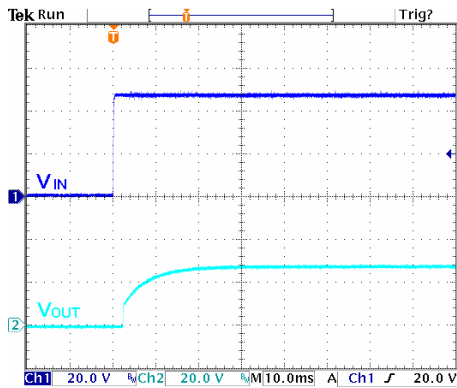

Typical Input Start-Up and Output Rise Characteristic
Vin = Vin(nom), Full Load

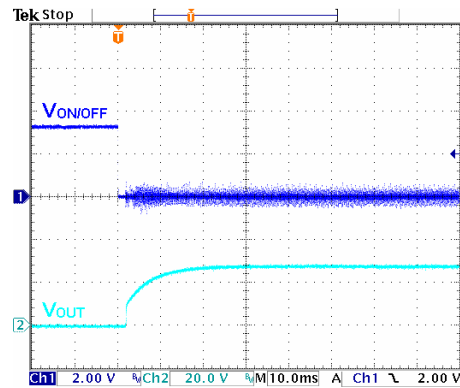

Using ON/OFF Voltage Start-Up and Vo Rise Characteristic
Vin = Vin(nom), Full Load

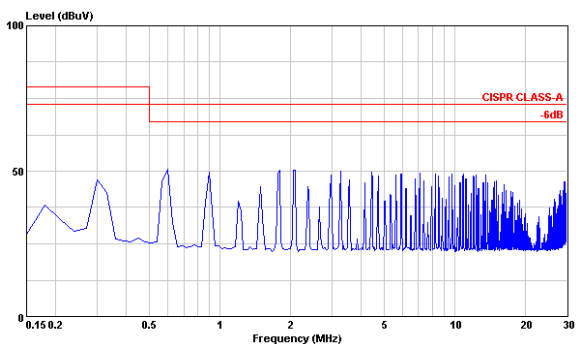

Conduction Emission of EN55022 Class A
Vin = Vin(nom), Full Load

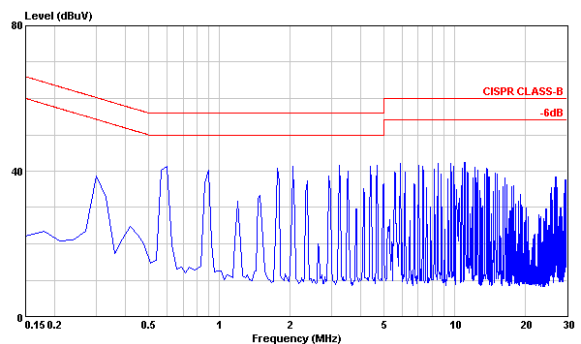

Conduction Emission of EN55022 Class B
Vin = Vin(nom), Full Load

Characteristic Curves

All test conditions are at 25°C. The figures are identical for TEP 75-4818WI

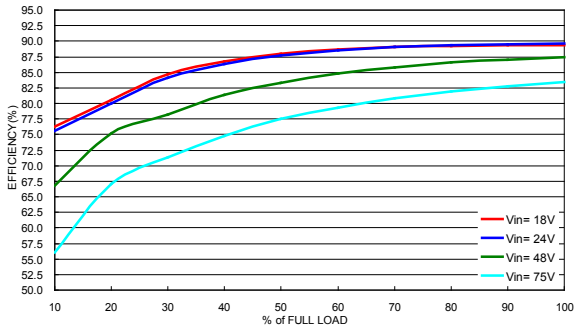

Efficiency versus Output Current

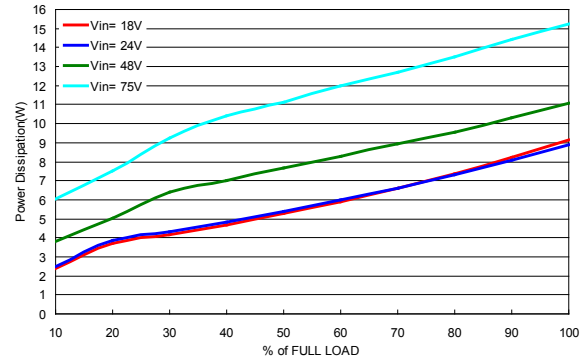

Power Dissipation versus Output Current

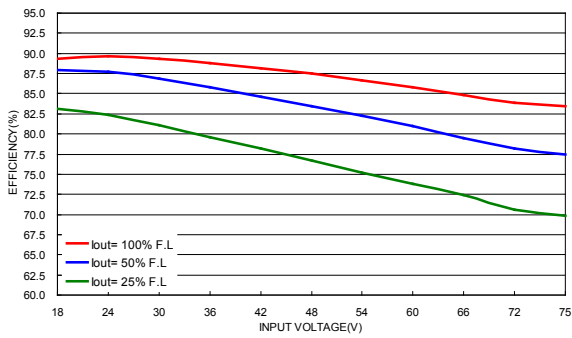

Efficiency versus Input Voltage. Full Load

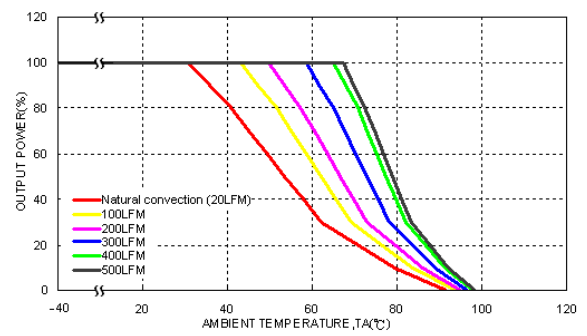

Derating Output Current versus Ambient Temperature with Airflow , Vin = Vin(nom)

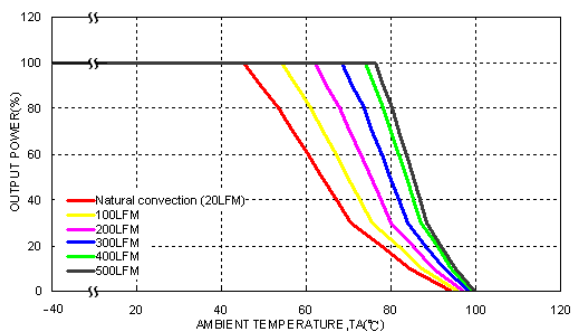

Derating Output Current versus Ambient Temperature with 0.24" Heat-Sink and Airflow , Vin = Vin(nom)

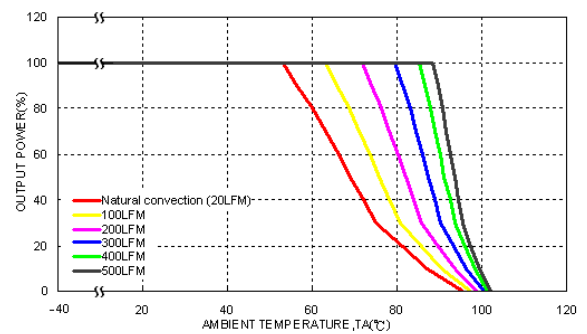

Derating Output Current versus Ambient Temperature with 0.45" Heat-Sink and Airflow , Vin = Vin(nom)

Characteristic Curves

All test conditions are at 25°C. The figures are identical for TEP 75-4818WI (continued)

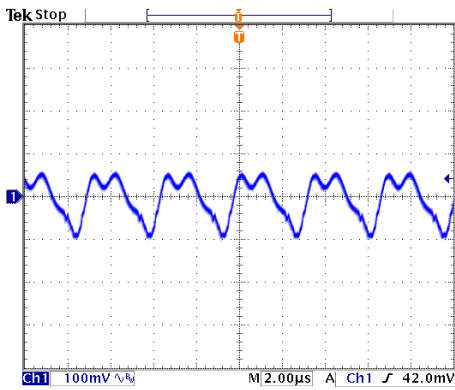

Typical Output Ripple and Noise.
Vin = Vin(nom), Full Load

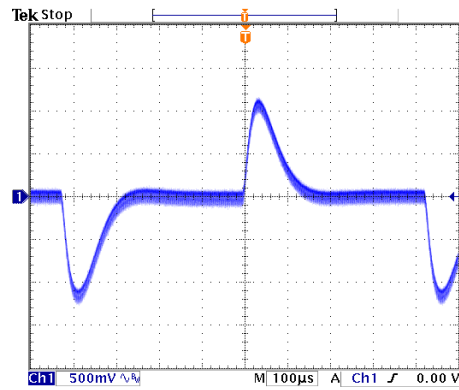

Transient Response to Dynamic Load Change from 100% to 75% to 100% of Full Load , Vin = Vin(nom)

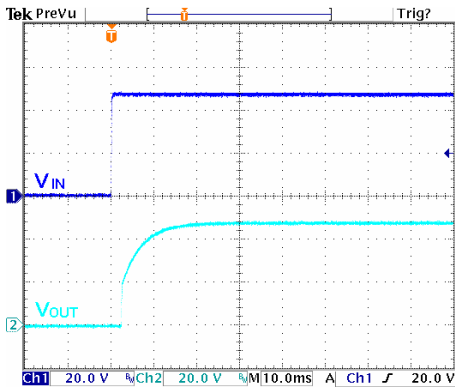

Typical Input Start-Up and Output Rise Characteristic
Vin = Vin(nom), Full Load

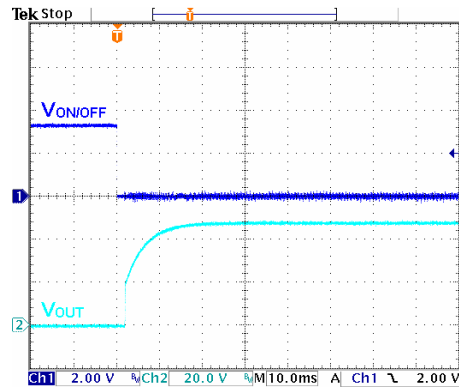

Using ON/OFF Voltage Start-Up and Vo Rise Characteristic
Vin = Vin(nom), Full Load

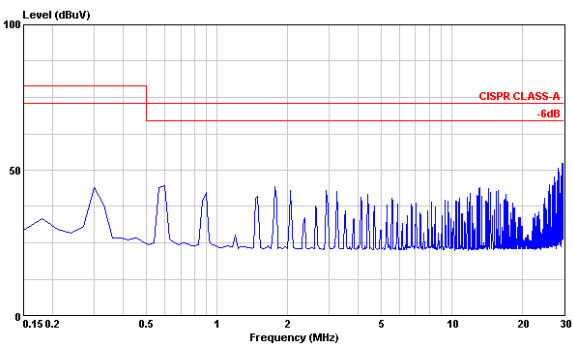

Conduction Emission of EN55022 Class A
Vin = Vin(nom), Full Load

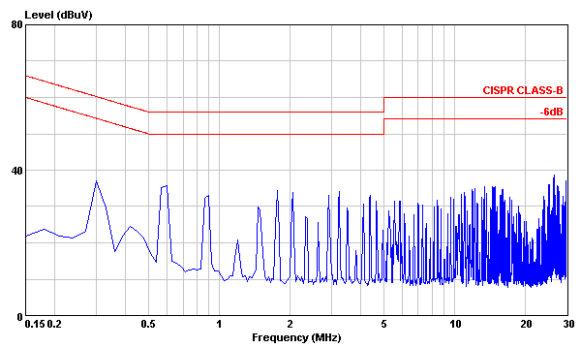

Conduction Emission of EN55022 Class B
Vin = Vin(nom), Full Load

Characteristic Curves

All test conditions are at 25°C. The figures are identical for TEP 75-7210WI

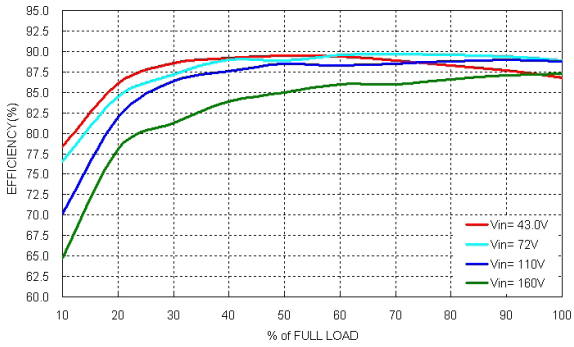

Efficiency versus Output Current

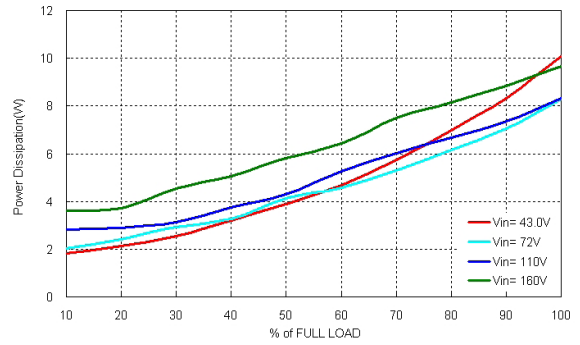

Power Dissipation versus Output Current

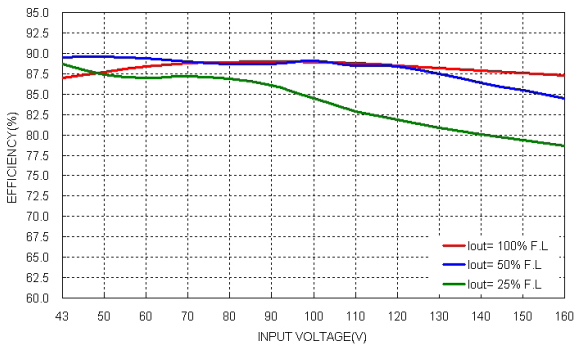

Efficiency versus Input Voltage. Full Load

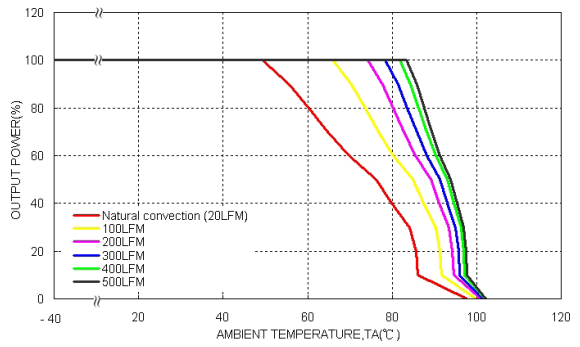

Derating Output Current versus Ambient Temperature with Airflow , Vin = Vin(nom)

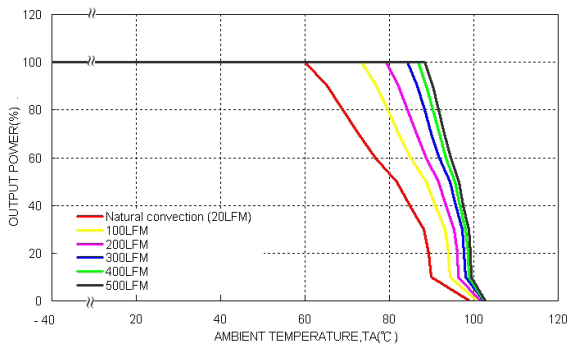

Derating Output Current Versus Ambient Temperature with 0.24" Heat-Sink and Airflow , Vin = Vin(nom)

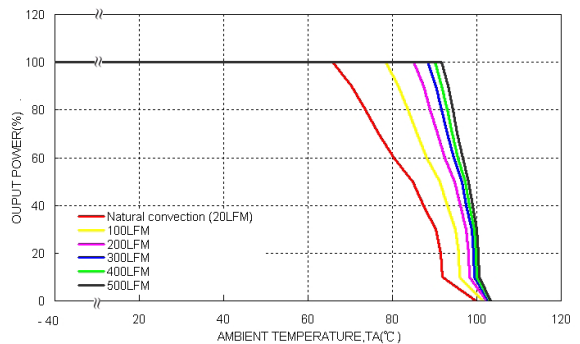

Derating Output Current Versus Ambient Temperature with 0.45" Heat-Sink and Airflow , Vin = Vin(nom)

Characteristic Curves

All test conditions are at 25°C. The figures are identical for TEP 75-7210WI (continued)

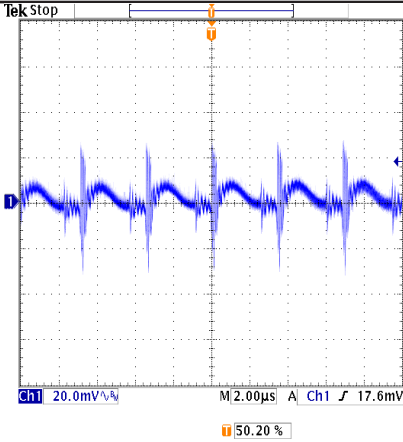

Typical Output Ripple and Noise.
Vin = Vin(nom), Full Load

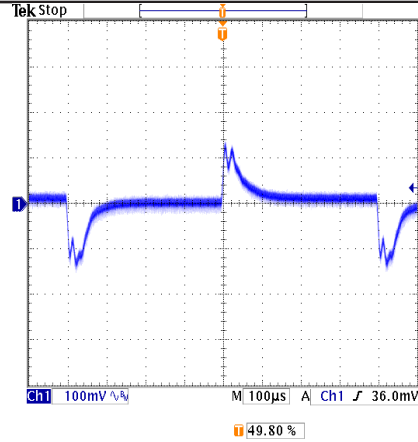

Transient Response to Dynamic Load Change from 100% to 75% to 100% of Full Load , Vin = Vin(nom)

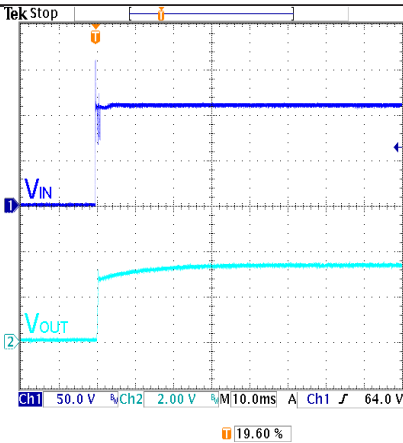

Typical Input Start-Up and Output Rise Characteristic
Vin = Vin(nom), Full Load

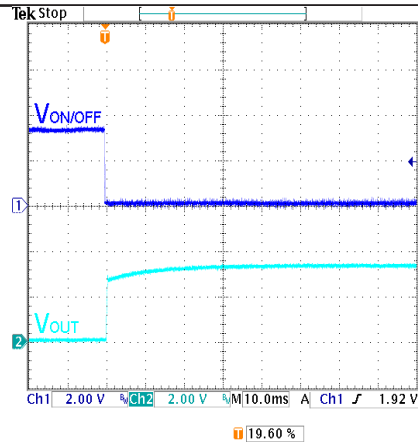

Using ON/OFF Voltage Start-Up and Vo Rise Characteristic
Vin = Vin(nom), Full Load

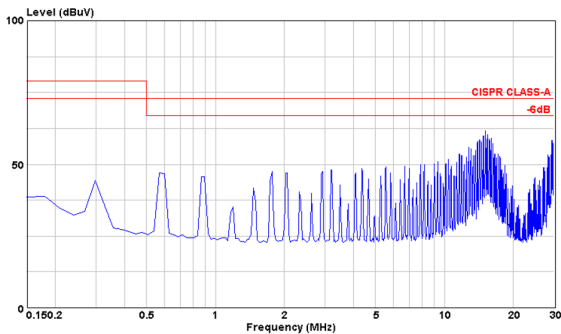

Conduction Emission of EN55022 Class A
Vin = Vin(nom), Full Load

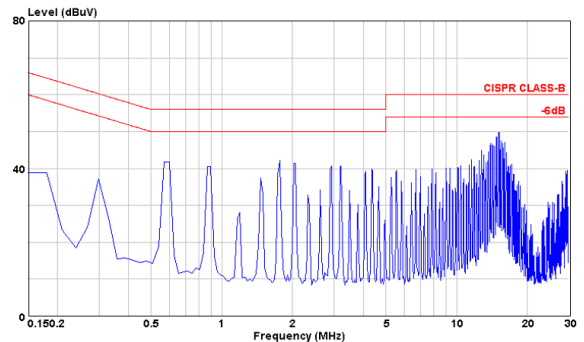

Conduction Emission of EN55022 Class B
Vin = Vin(nom), Full Load

Characteristic Curves

All test conditions are at 25°C. The figures are identical for TEP 75-7211WI

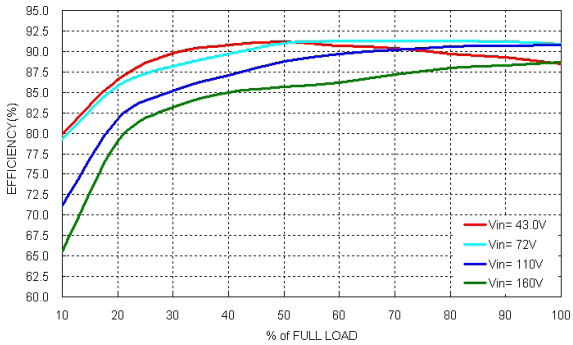

Efficiency versus Output Current

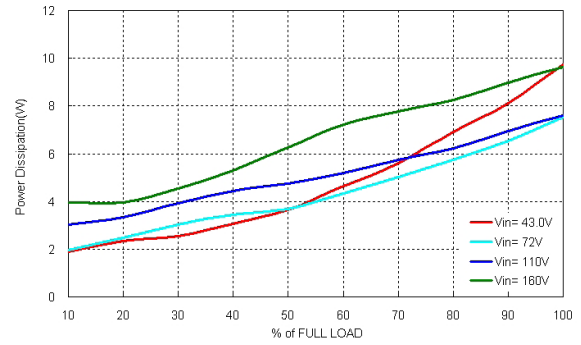

Power Dissipation versus Output Current

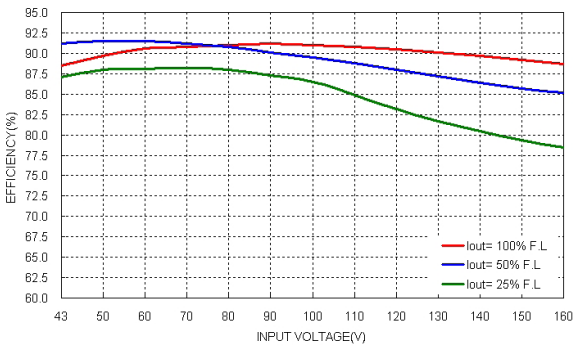

Efficiency versus Input Voltage. Full Load

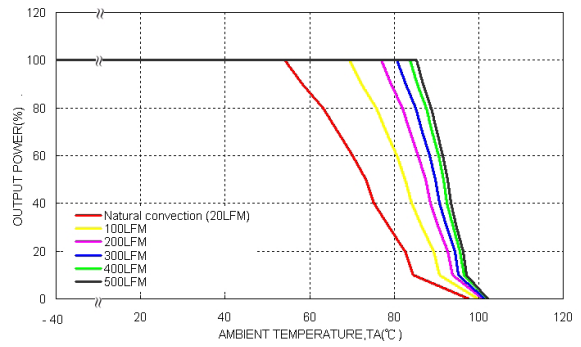

Derating Output Current versus Ambient Temperature with Airflow , Vin = Vin(nom)

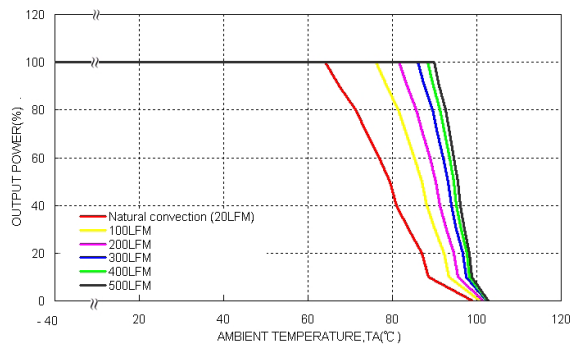

Derating Output Current Versus Ambient Temperature with 0.24'' Heat-Sink and Airflow , Vin = Vin(nom)

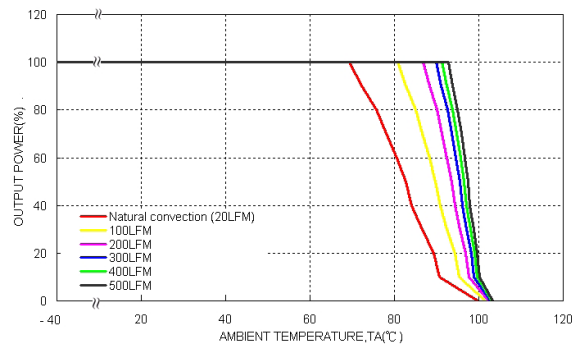

Derating Output Current Versus Ambient Temperature with 0.45'' Heat-Sink and Airflow , Vin = Vin(nom)

Characteristic Curves

All test conditions are at 25°C. The figures are identical for TEP 75-7211WI (continued)

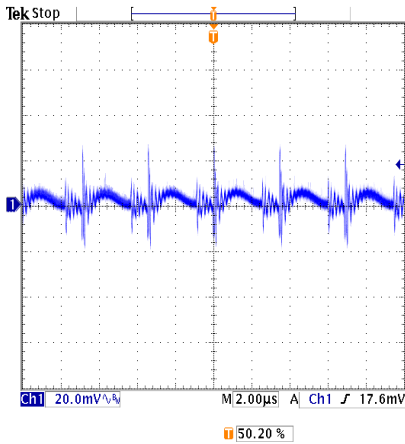

Typical Output Ripple and Noise.
Vin = Vin(nom), Full Load

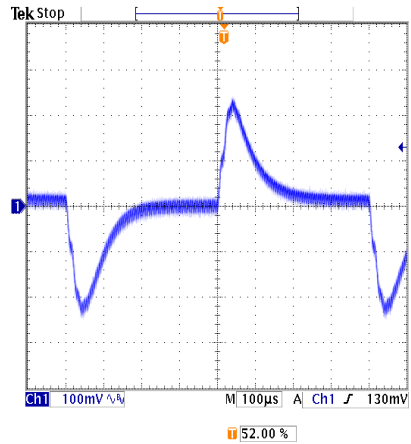

Transient Response to Dynamic Load Change from 100% to 75% to 100% of Full Load , Vin = Vin(nom)

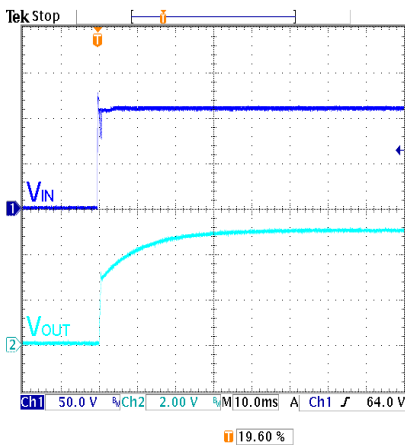

Typical Input Start-Up and Output Rise Characteristic
Vin = Vin(nom), Full Load

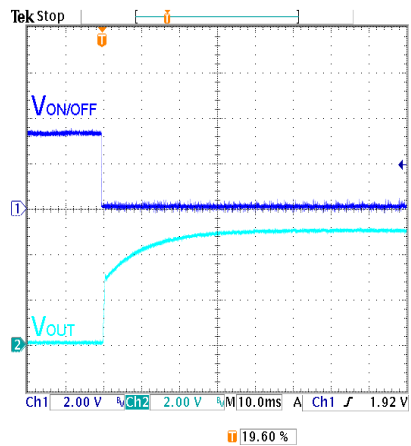

Using ON/OFF Voltage Start-Up and Vo Rise Characteristic
Vin = Vin(nom), Full Load

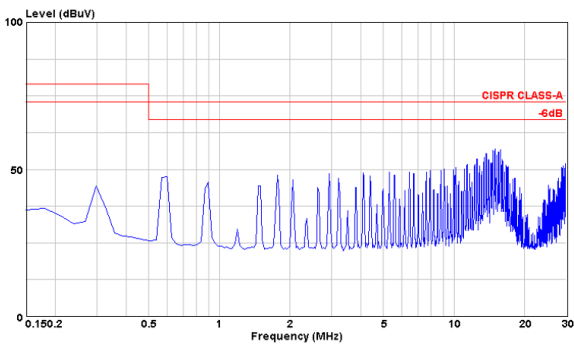

Conduction Emission of EN55022 Class A
Vin = Vin(nom), Full Load

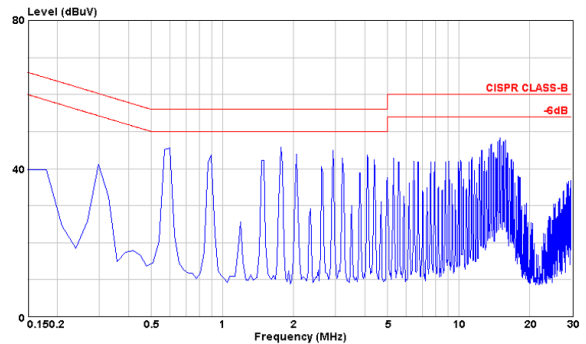

Conduction Emission of EN55022 Class B
Vin = Vin(nom), Full Load

Characteristic Curves

All test conditions are at 25°C. The figures are identical for TEP 75-7212WI

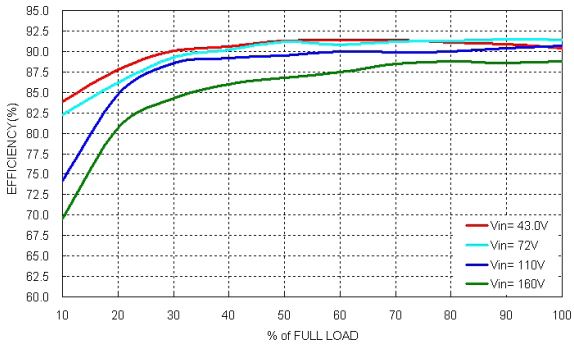

Efficiency versus Output Current

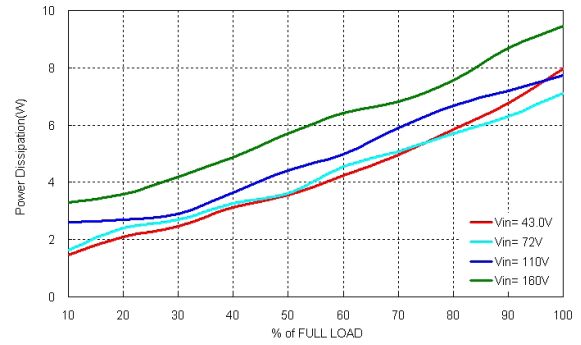

Power Dissipation versus Output Current

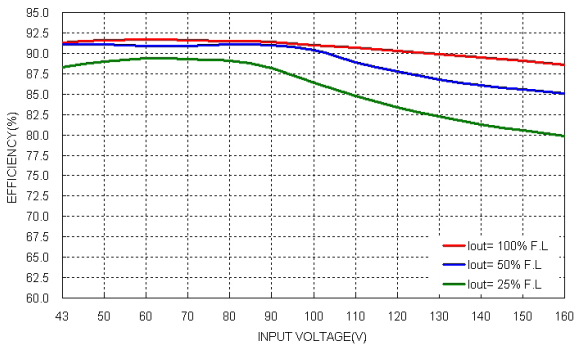

Efficiency versus Input Voltage. Full Load

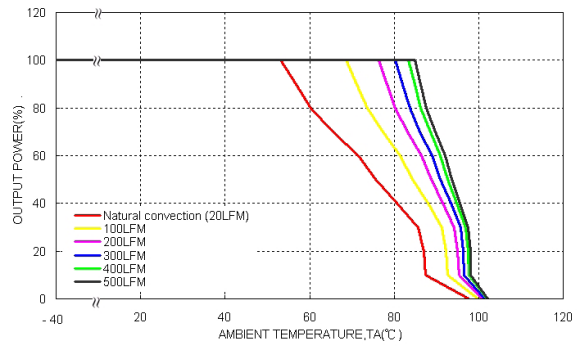

Derating Output Current versus Ambient Temperature with Airflow , Vin = Vin(nom)

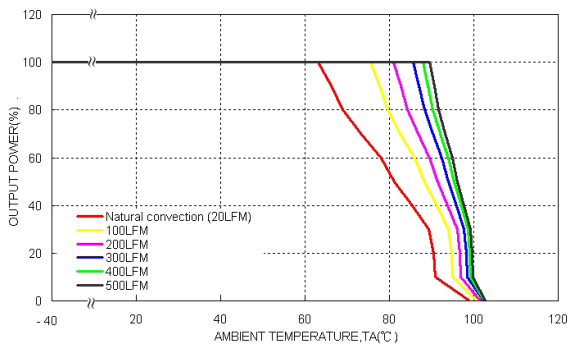

Derating Output Current Versus Ambient Temperature with 0.24'' Heat-Sink and Airflow , Vin = Vin(nom)

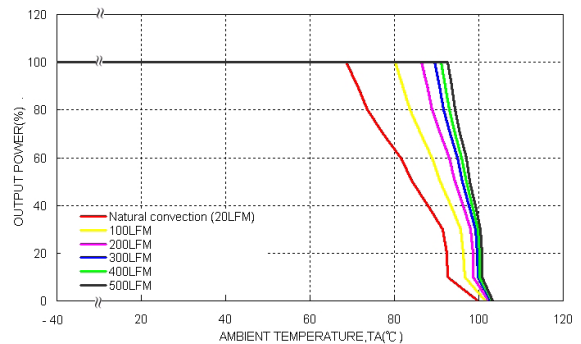

Derating Output Current Versus Ambient Temperature with 0.45'' Heat-Sink and Airflow , Vin = Vin(nom)

Characteristic Curves

All test conditions are at 25°C. The figures are identical for TEP 75-7212WI (continued)

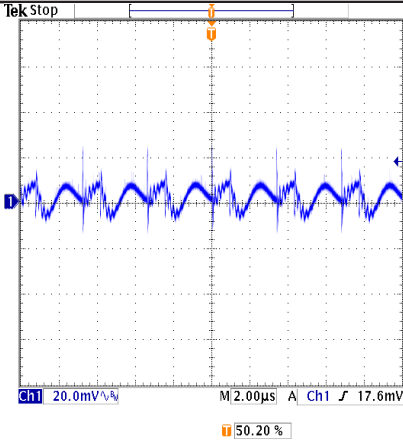

Typical Output Ripple and Noise.
Vin = Vin(nom), Full Load

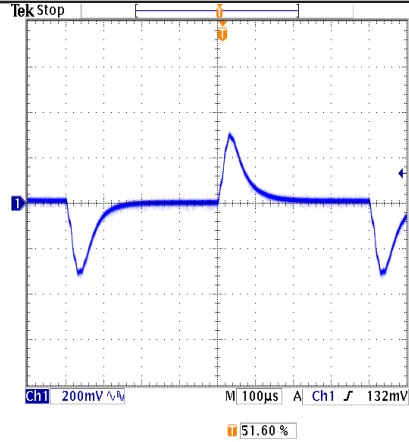

Transient Response to Dynamic Load Change from 100% to 75% to 100% of Full Load , Vin = Vin(nom)

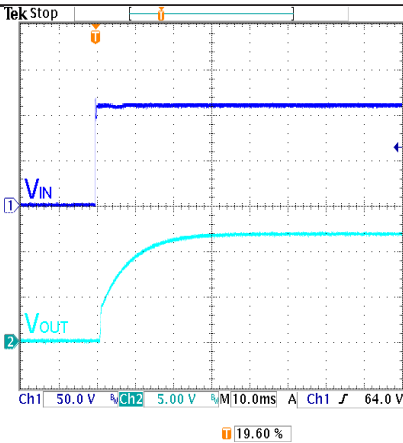

Typical Input Start-Up and Output Rise Characteristic
Vin = Vin(nom), Full Load

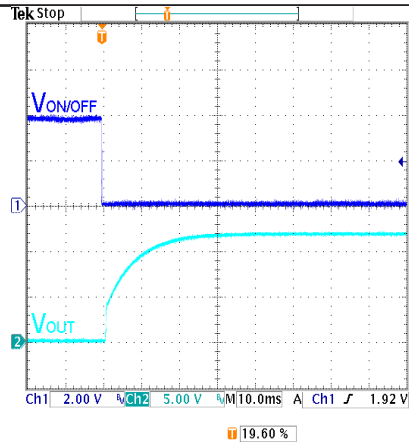

Using ON/OFF Voltage Start-Up and Vo Rise Characteristic
Vin = Vin(nom), Full Load

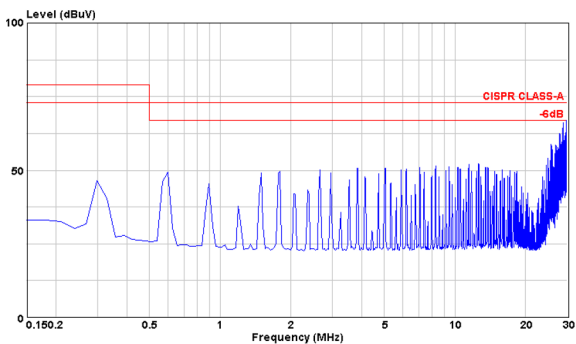

Conduction Emission of EN55022 Class A
Vin = Vin(nom), Full Load

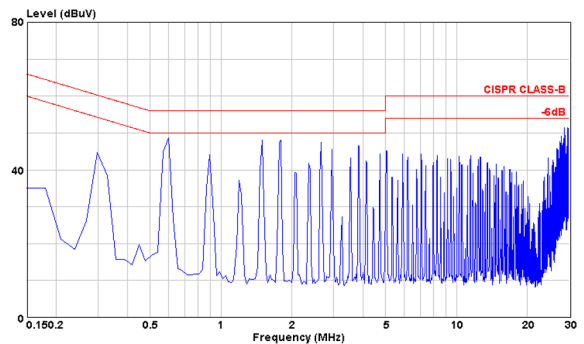

Conduction Emission of EN55022 Class B
Vin = Vin(nom), Full Load

Characteristic Curves

All test conditions are at 25°C. The figures are identical for TEP 75-7213WI

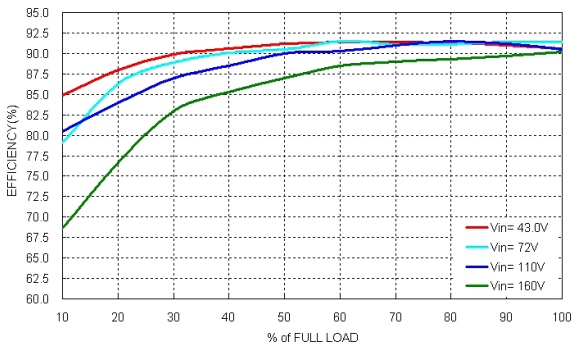

Efficiency versus Output Current

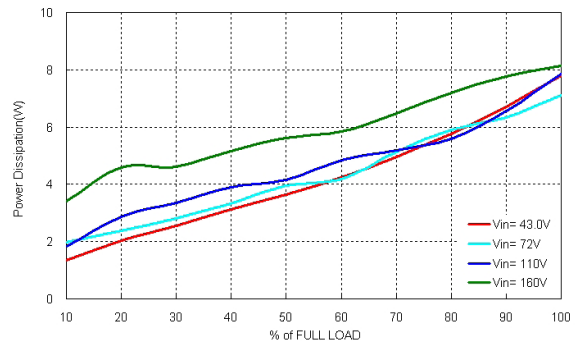

Power Dissipation versus Output Current

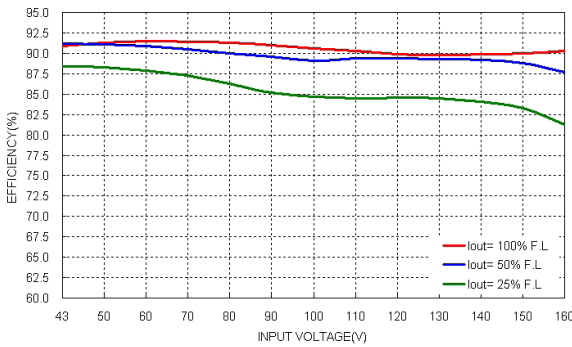

Efficiency versus Input Voltage. Full Load

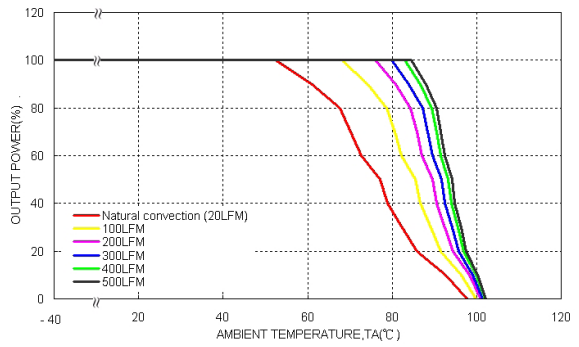

Derating Output Current versus Ambient Temperature with Airflow , Vin = Vin(nom)

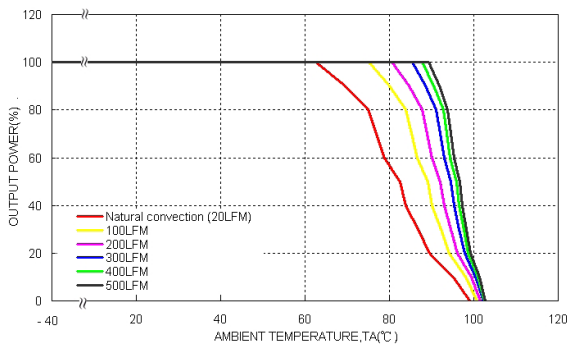

Derating Output Current Versus Ambient Temperature with 0.24'' Heat-Sink and Airflow , Vin = Vin(nom)

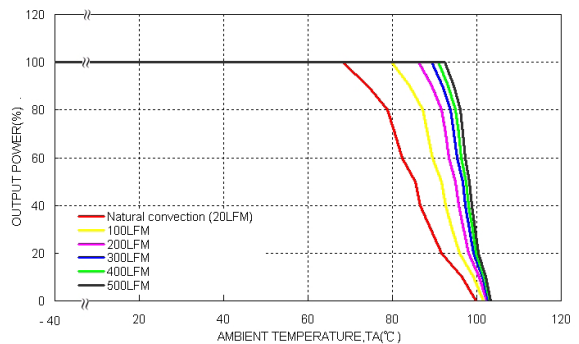

Derating Output Current Versus Ambient Temperature with 0.45'' Heat-Sink and Airflow , Vin = Vin(nom)

Characteristic Curves

All test conditions are at 25°C. The figures are identical for TEP 75-7213WI (continued)

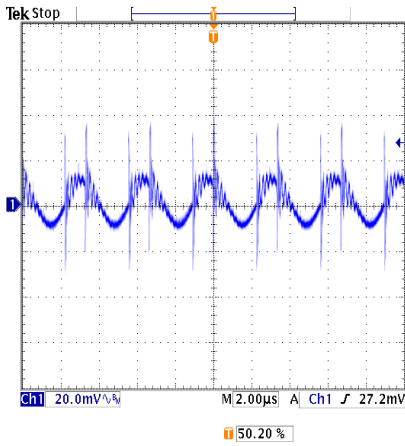

Typical Output Ripple and Noise.
Vin = Vin(nom), Full Load

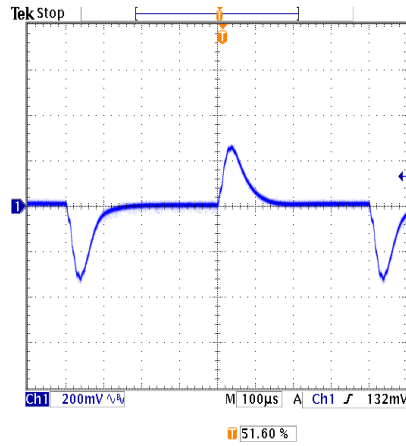

Transient Response to Dynamic Load Change from 100% to 75% to 100% of Full Load , Vin = Vin(nom)

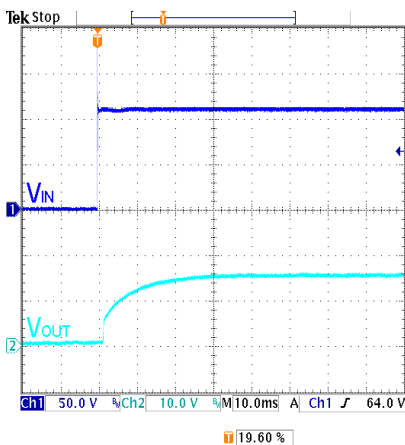

Typical Input Start-Up and Output Rise Characteristic
Vin = Vin(nom), Full Load

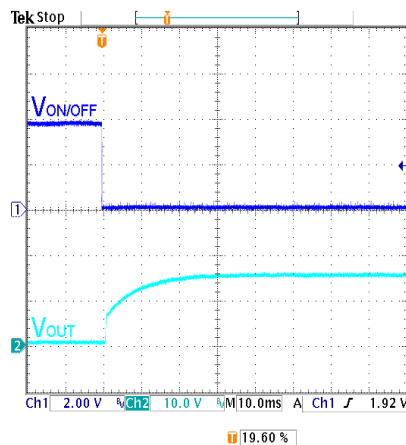

Using ON/OFF Voltage Start-Up and Vo Rise Characteristic
Vin = Vin(nom), Full Load

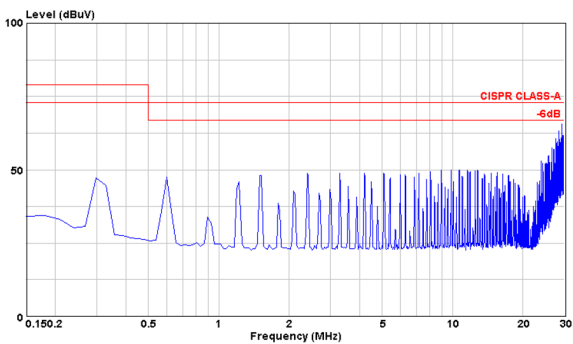

Conduction Emission of EN55022 Class A
Vin = Vin(nom), Full Load

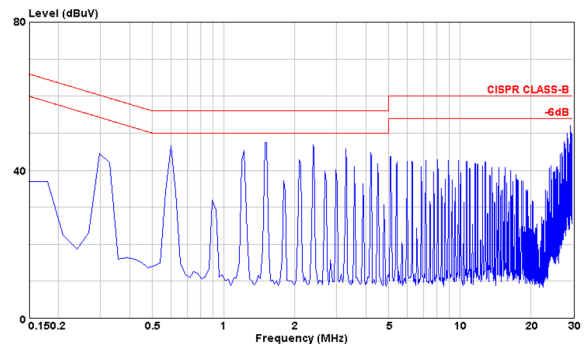

Conduction Emission of EN55022 Class B
Vin = Vin(nom), Full Load

Characteristic Curves

All test conditions are at 25°C. The figures are identical for TEP 75-7215WI

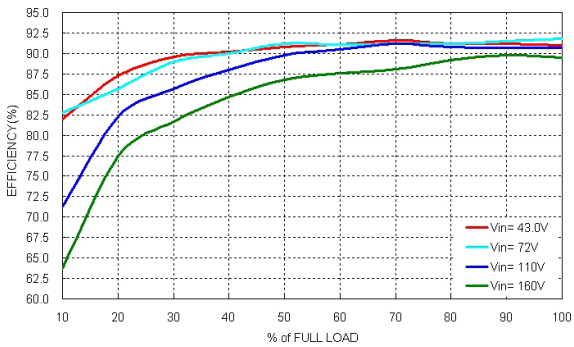

Efficiency versus Output Current

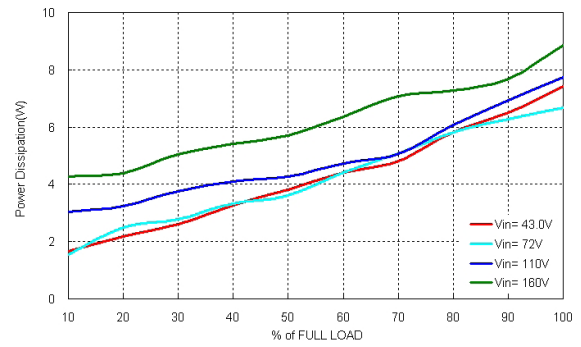

Power Dissipation versus Output Current

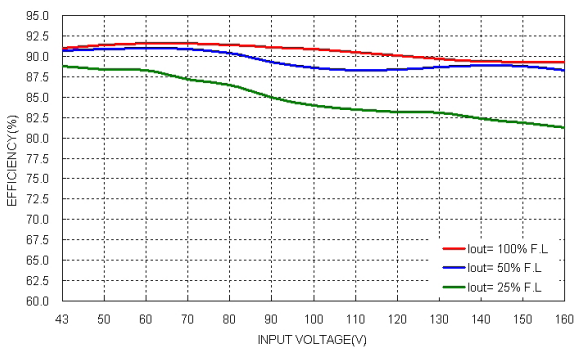

Efficiency versus Input Voltage. Full Load

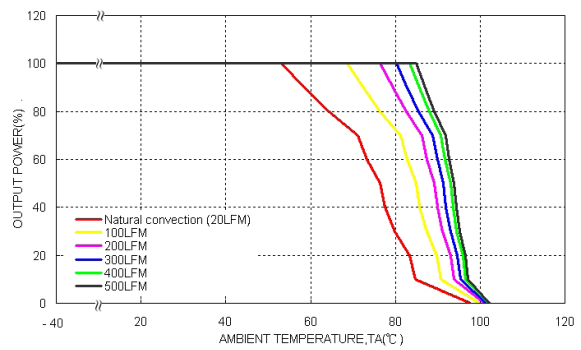

Derating Output Current versus Ambient Temperature with Airflow , Vin = Vin(nom)

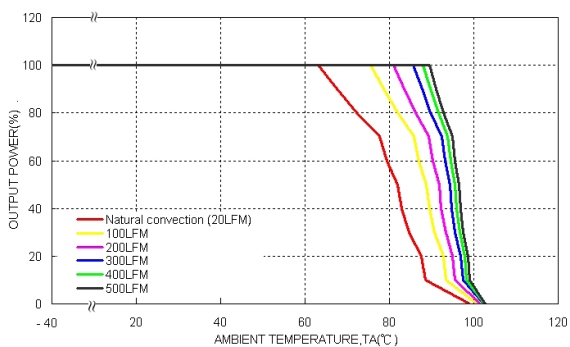

Derating Output Current Versus Ambient Temperature with 0.24'' Heat-Sink and Airflow , Vin = Vin(nom)

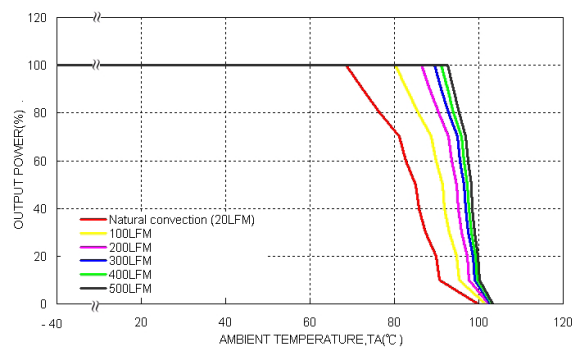

Derating Output Current Versus Ambient Temperature with 0.45'' Heat-Sink and Airflow , Vin = Vin(nom)

Characteristic Curves

All test conditions are at 25°C. The figures are identical for TEP 75-7215WI (continued)

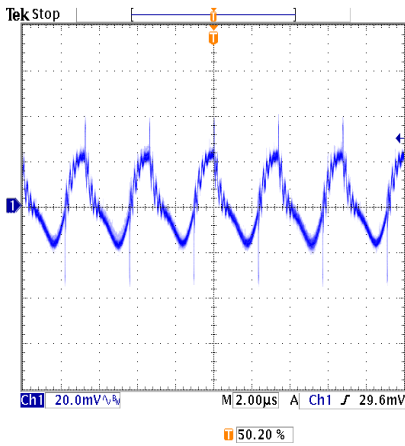

Typical Output Ripple and Noise.
Vin = Vin(nom), Full Load

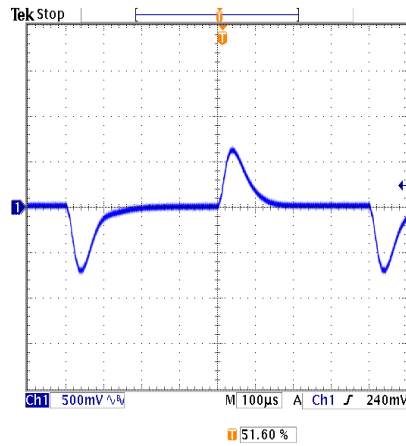

Transient Response to Dynamic Load Change from 100% to 75% to 100% of Full Load , Vin = Vin(nom)

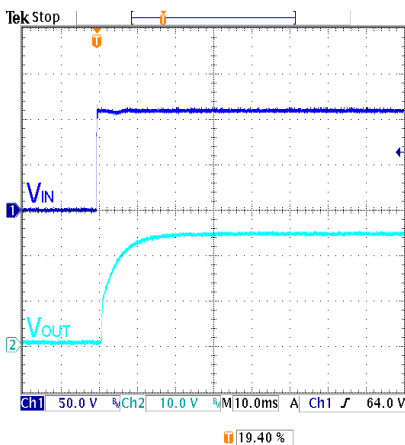

Typical Input Start-Up and Output Rise Characteristic
Vin = Vin(nom), Full Load

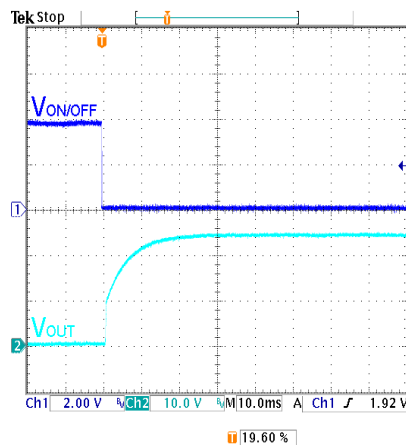

Using ON/OFF Voltage Start-Up and Vo Rise Characteristic
Vin = Vin(nom), Full Load

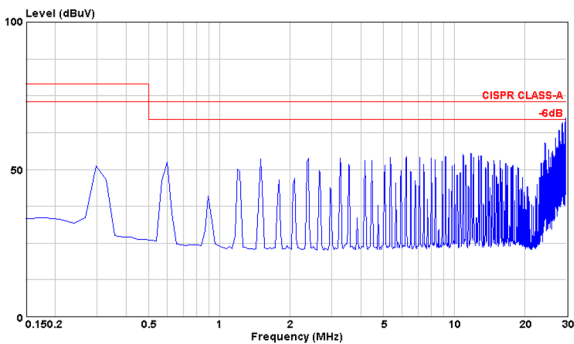

Conduction Emission of EN55022 Class A
Vin = Vin(nom), Full Load

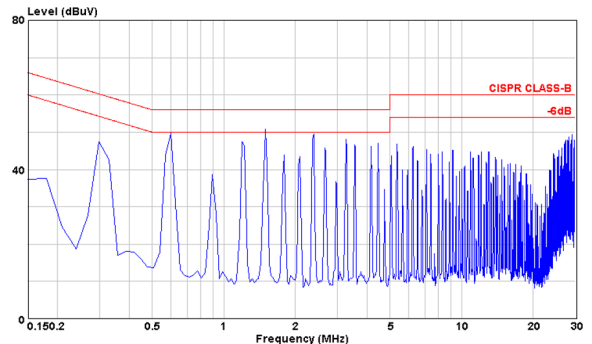

Conduction Emission of EN55022 Class B
Vin = Vin(nom), Full Load

Characteristic Curves

All test conditions are at 25°C. The figures are identical for TEP 75-7216WI

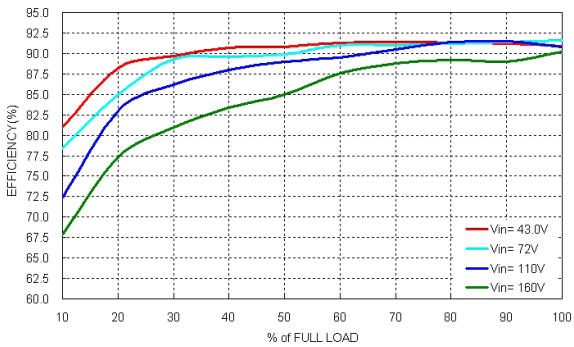

Efficiency versus Output Current

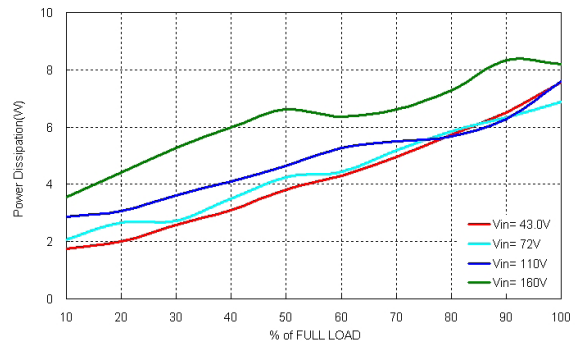

Power Dissipation versus Output Current

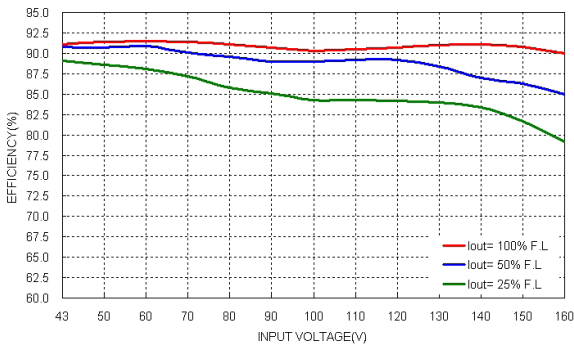

Efficiency versus Input Voltage. Full Load



Derating Output Current versus Ambient Temperature with Airflow , Vin = Vin(nom)

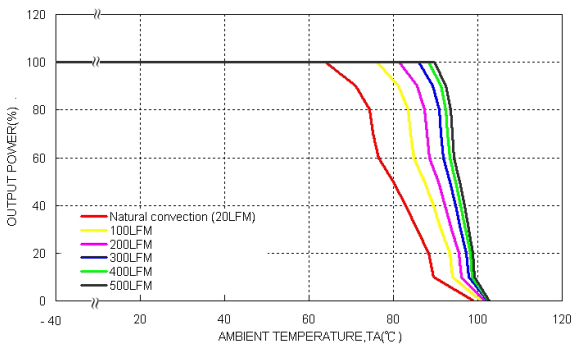

Derating Output Current Versus Ambient Temperature with 0.24'' Heat-Sink and Airflow , Vin = Vin(nom)

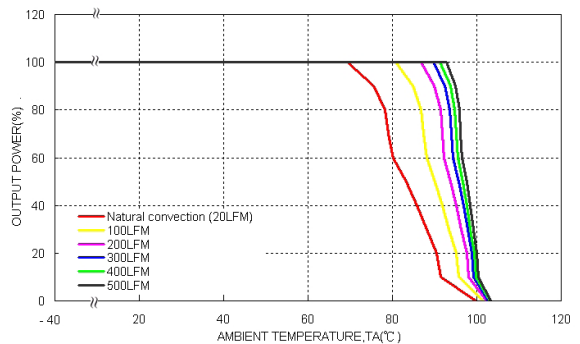

Derating Output Current Versus Ambient Temperature with 0.45'' Heat-Sink and Airflow , Vin = Vin(nom)

Characteristic Curves

All test conditions are at 25°C. The figures are identical for TEP 75-7216WI (continued)

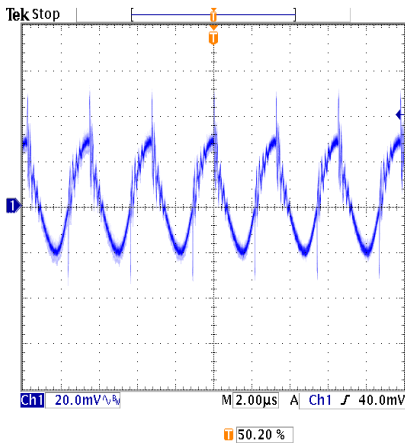

Typical Output Ripple and Noise.
Vin = Vin(nom), Full Load

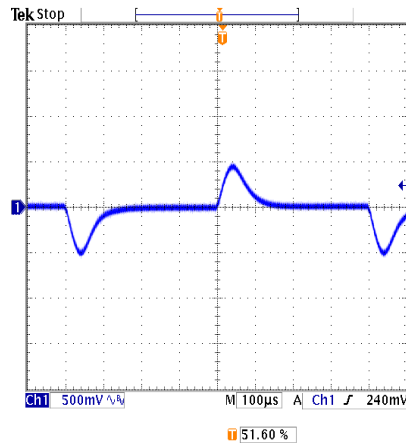

Transient Response to Dynamic Load Change from 100% to 75% to 100% of Full Load , Vin = Vin(nom)

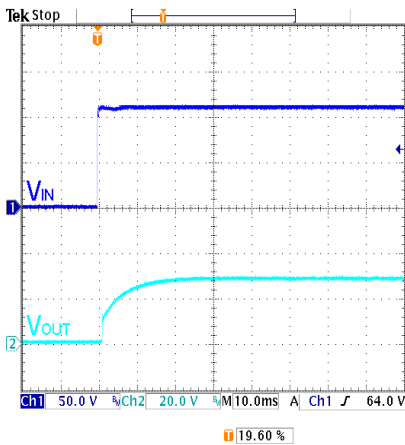

Typical Input Start-Up and Output Rise Characteristic
Vin = Vin(nom), Full Load

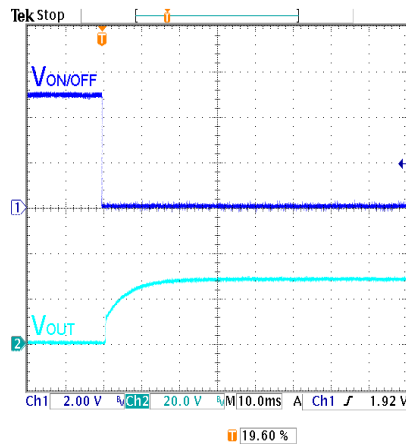

Using ON/OFF Voltage Start-Up and Vo Rise Characteristic
Vin = Vin(nom), Full Load

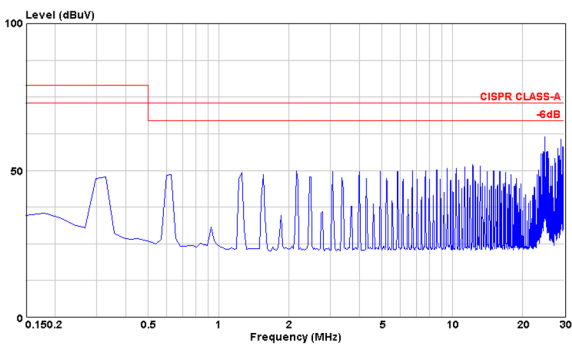

Conduction Emission of EN55022 Class A
Vin = Vin(nom), Full Load

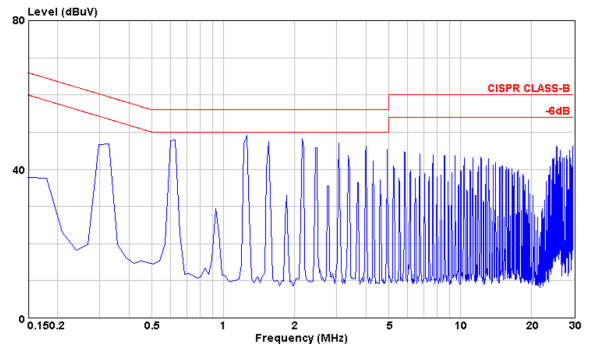

Conduction Emission of EN55022 Class B
Vin = Vin(nom), Full Load

Characteristic Curves

All test conditions are at 25°C. The figures are identical for TEP 75-7218WI

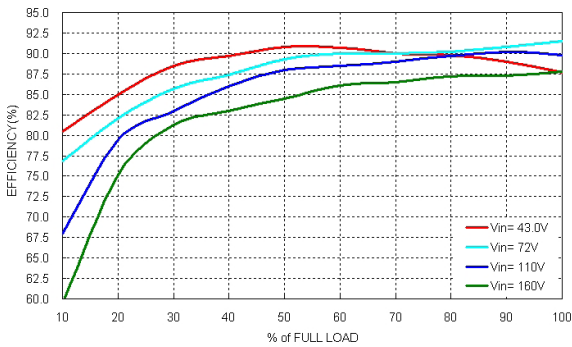

Efficiency versus Output Current

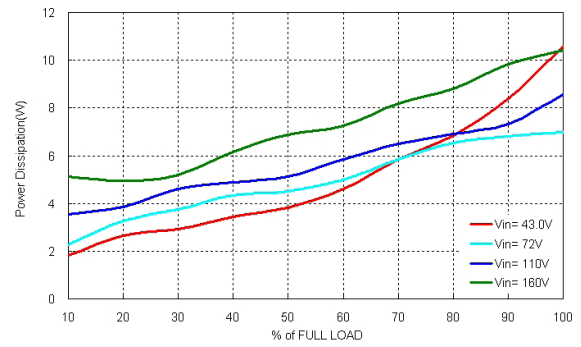

Power Dissipation versus Output Current

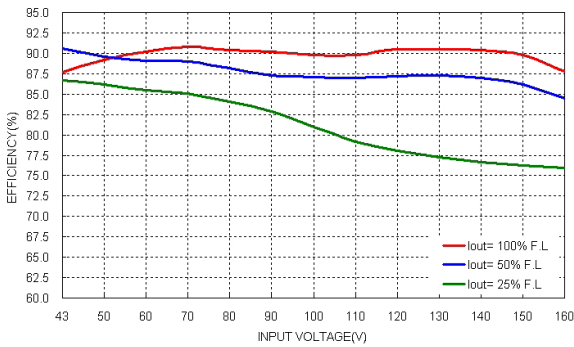

Efficiency versus Input Voltage. Full Load

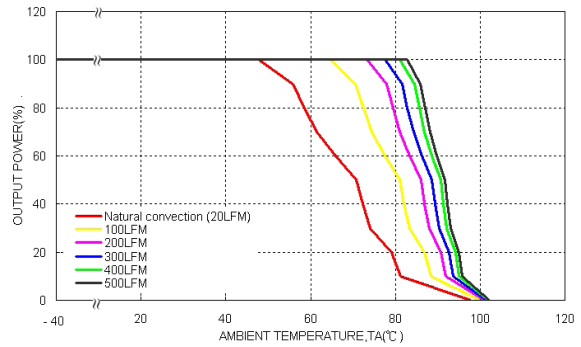

Derating Output Current versus Ambient Temperature with Airflow , Vin = Vin(nom)

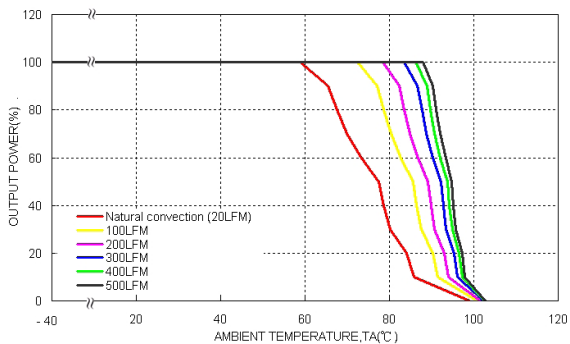

Derating Output Current Versus Ambient Temperature with 0.24" Heat-Sink and Airflow , Vin = Vin(nom)

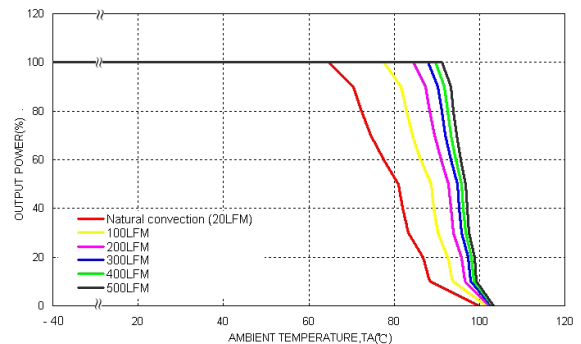

Derating Output Current Versus Ambient Temperature with 0.45" Heat-Sink and Airflow , Vin = Vin(nom)

Characteristic Curves

All test conditions are at 25°C. The figures are identical for TEP 75-7218WI (continued)

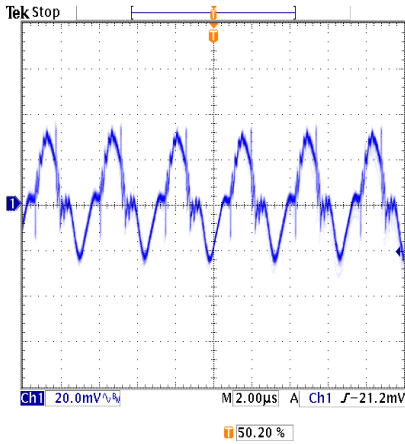

Typical Output Ripple and Noise.
Vin = Vin(nom), Full Load

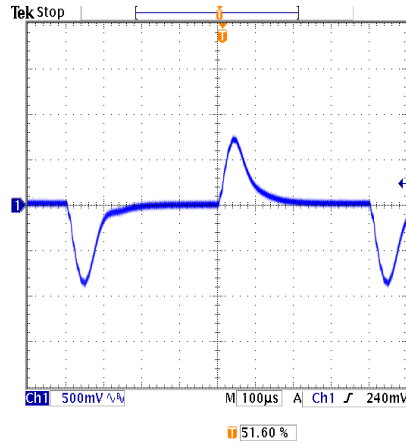

Transient Response to Dynamic Load Change from 100% to 75% to 100% of Full Load , Vin = Vin(nom)

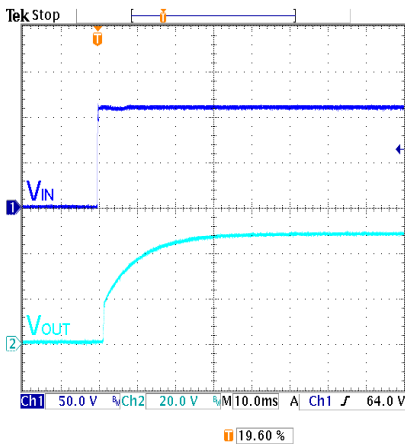

Typical Input Start-Up and Output Rise Characteristic
Vin = Vin(nom), Full Load

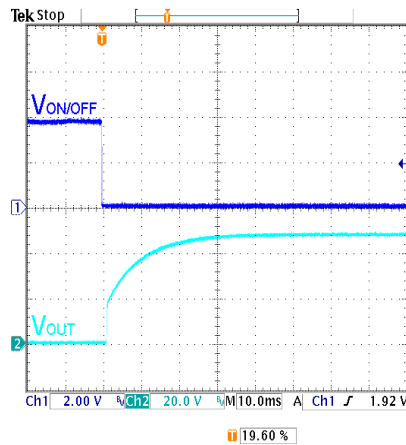

Using ON/OFF Voltage Start-Up and Vo Rise Characteristic
Vin = Vin(nom), Full Load

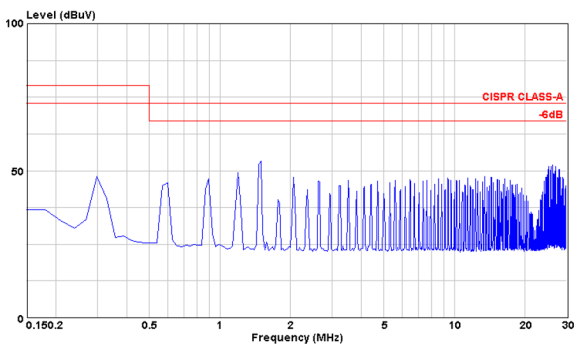

Conduction Emission of EN55022 Class A
Vin = Vin(nom), Full Load

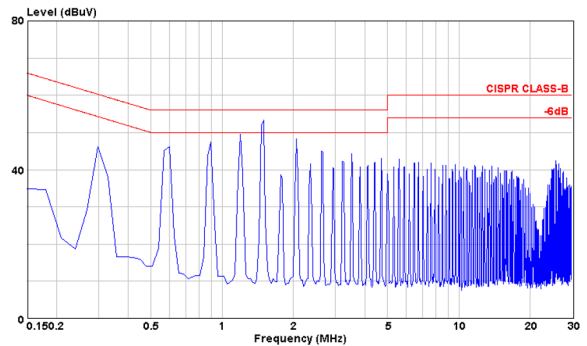

Conduction Emission of EN55022 Class B
Vin = Vin(nom), Full Load

Testing Configurations

Input reflected-ripple current measurement test up

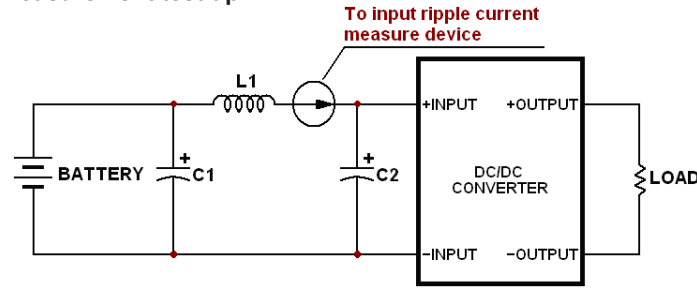

TEP 75-24xxWI / TEP 75-48xxWI

Component	Value	Voltage	Reference
L1	12μH	----	ARLITECH : ATP10705120
C1 & C2	100μF	100V	NIPPON CHEMICON : KY series EKY-101ELL101MK16S

TEP 75-72xxWI

Component	Value	Voltage	Reference
L1	12μH	----	ARLITECH : ATP10705120
C1 & C2	68μF	200V	Ruby-con: BXF series

Peak to peak output ripple & noise measurement test up

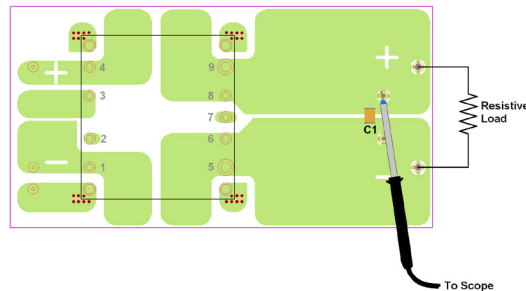

Device	Component	Value	Voltage	Reference
TEP 75-xx18WI	C1	2.2μF	100V	TDK : C4532X7R2A225M
others	C1	4.7μF	50V	TDK : C4532X7R1H475M

Output voltage and efficiency measurement test up

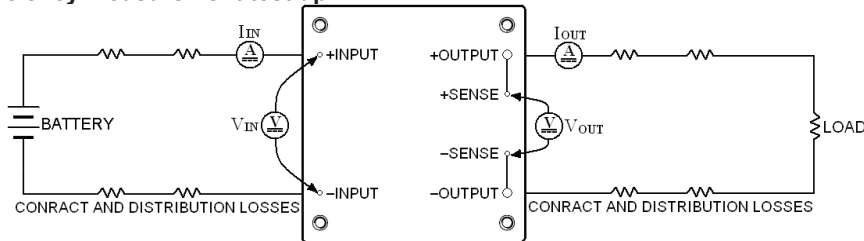

Note: All measurements are taken at the module terminals. $Efficiency = \left(\frac{V_{OUT} \times I_{OUT}}{V_N \times I_N} \right) \times 100\%$

EMI considerations

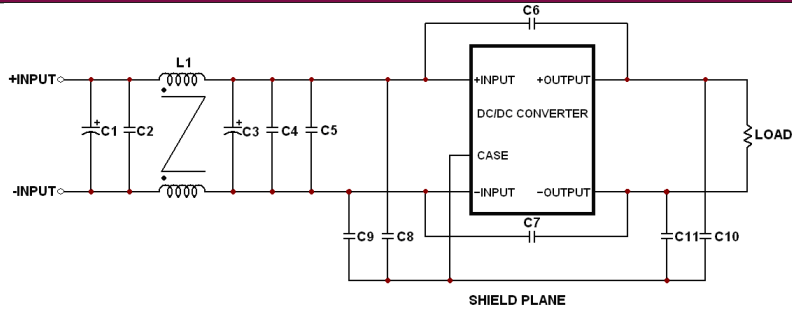

Suggested schematic for EN55022 conducted emission Class A limits

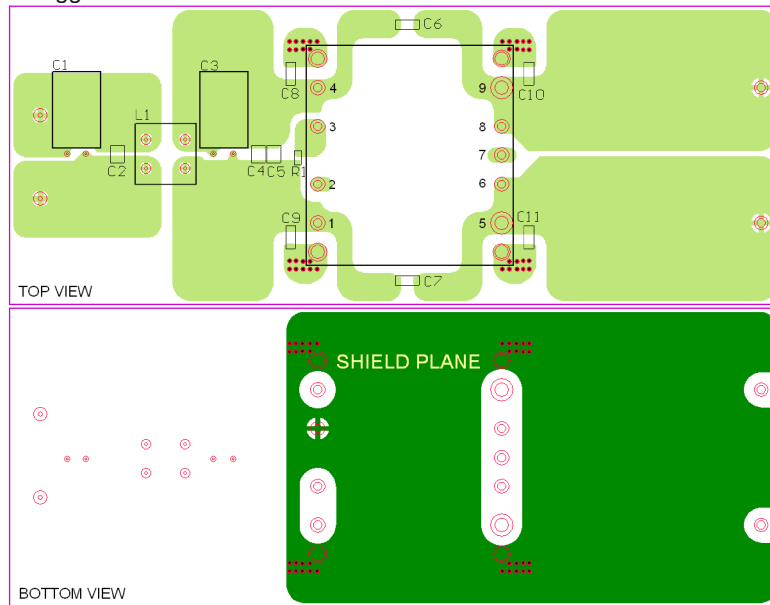

Recommended Layout With Input Filter

To meet conducted emissions EN55022 CLASS A needed the following components :
TEP 75-24xxWI

Component	Value	Voltage	Reference
C1 、 C3	100 μ F	50 V	Nippon chemi-con KY series
C2 、 C4 、 C5	4.7 μ F	50 V	1812 MLCC
C6 、 C7 、 C8 、 C9 、 C10 、 C11	1000 pF	3 KV	1808 MLCC
L1	156 μ H \pm 35%	----	Common Choke, P/N : PMT-072

TEP 75-48xxWI

Component	Value	Voltage	Reference
C1 、 C3	100 μ F	100 V	Nippon chemi-con KY series
C2 、 C4 、 C5	2.2 μ F	100 V	1812 MLCC
C6 、 C7 、 C8 、 C9 、 C10 、 C11	1000 pF	3 KV	1808 MLCC
L1	620 μ H \pm 35%	----	Common Choke, P/N : PMT-067

Note : 1. Common mode choke have been define and show in page 54.
2. While testing, connect the CASE pin and four screw bolts to shield plane, the EMI could be reduced.

EMI considerations

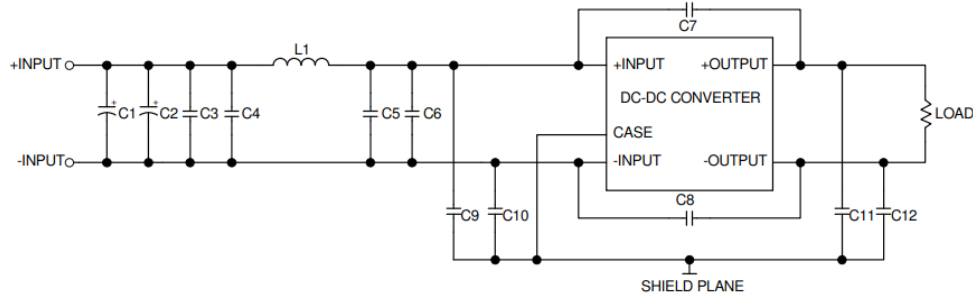

Suggested schematic for EN55022 conducted emission Class A limits

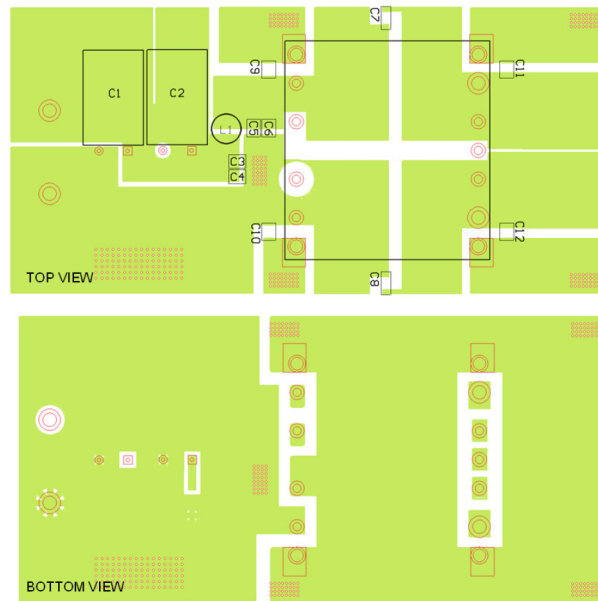

Recommended Layout With Input Filter

To meet conducted emissions EN55022 CLASS A needed the following components :
TEP 75-72xxWI

Component	Value	Voltage	Reference
C1, C2	150 μ F	200 V	Nippon chemi-con KXJ series
C6	1 μ F	250 V	1812 MLCC
C7, C8	1000 pF	3 KV	1808 MLCC
L1	4.7 μ H \pm 20%	----	Inductor, P/N : TCK-099

Note : 1. Inductor L1 has been defined and show in page 54.

2. While testing, connect the CASE pin and four screw bolts to shield plane, the EMI could be reduced.

EMI considerations (continued)

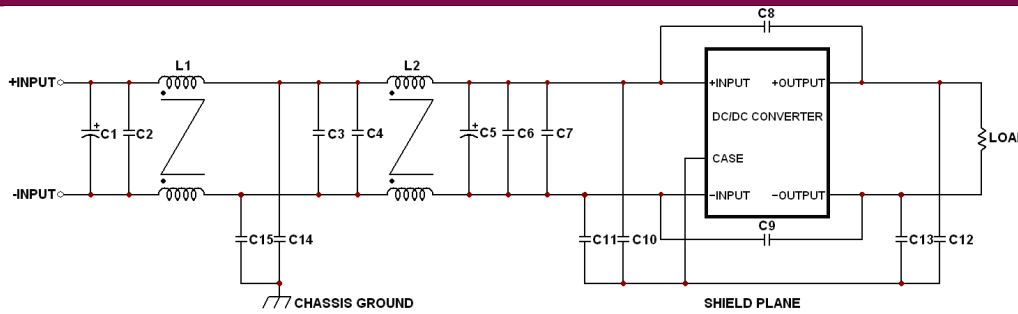

Suggested schematic for EN55022 conducted emission Class B limits

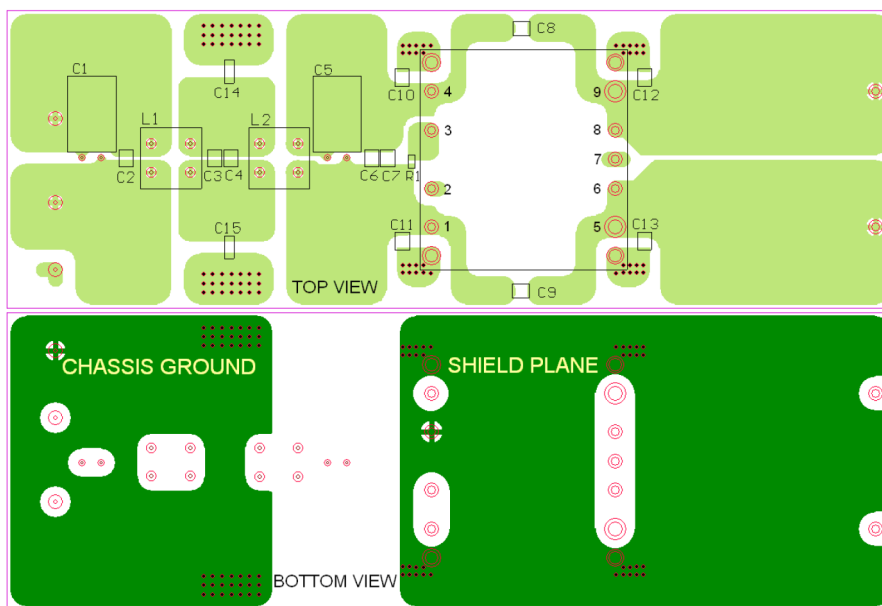

Recommended Layout With Input Filter

To meet conducted emissions EN55022 CLASS B needed the following components :
TEP 75-24xxWI

Component	Value	Voltage	Reference
C1 、 C5	100 μ F	50 V	Nippon chemi-con KY series
C2 、 C3 、 C4 、 C6 、 C7	4.7 μ F	50 V	1812 MLCC
C8 、 C9 、 C14 、 C15	1000 pF	3 KV	1808 MLCC
C10 、 C11 、 C12 、 C13	10 nF	2 KV	1812 MLCC
L1 、 L2	305 μ H \pm 35%	----	Common Choke, P/N : TCK-073

TEP 75-48xxWI

Component	Value	Voltage	Reference
C1 、 C5	100 μ F	100 V	Nippon chemi-con KY series
C2 、 C3 、 C4 、 C6 、 C7	2.2 μ F	100 V	1812 MLCC
C8 、 C14 、 C15	1000 pF	3 KV	1808 MLCC
C9	4700 pF	3 KV	1812 MLCC
C10 、 C11 、 C12 、 C13	10 nF	2 KV	1812 MLCC
L1	1186 μ H \pm 35%	----	Common Choke, P/N: TCK-064
L2	156 μ H \pm 35%	----	Common Choke, P/N \square PMT-072

- Note : 1. Common mode choke have been define and show in page 54.
2. While testing, connect the CASE pin and four screw bolts to shield plane, the EMI could be reduced.

EMI considerations (continued)

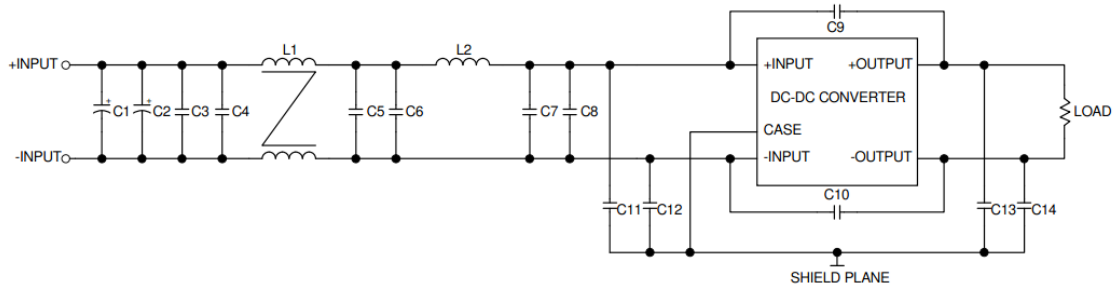

Suggested schematic for EN55022 conducted emission Class B limits

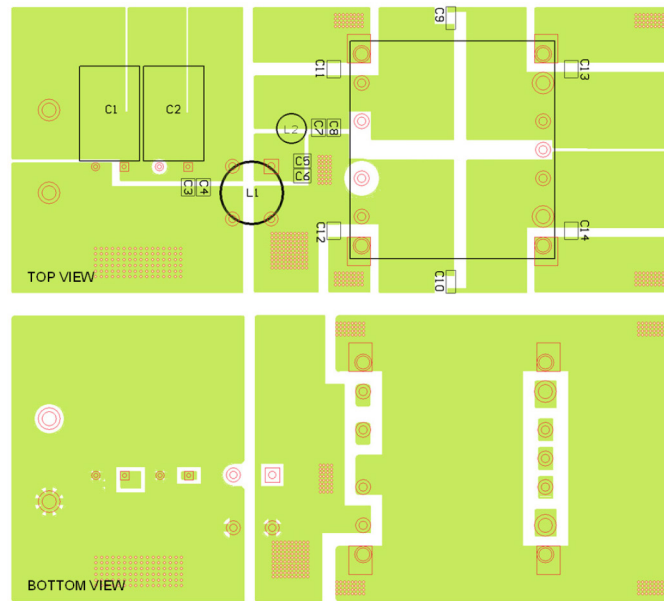

Recommended Layout With Input Filter

To meet conducted emissions EN55022 CLASS B needed the following components :

TEP 75-72xxWI

Component	Value	Voltage	Reference
C1, C2	150 μ F	200 V	Nippon chemi-con KXJ series
C5, C6, C7, C8	1 μ F	250 V	1812 MLCC
C9, C10, C11, C12, C13, C14	1000 pF	3 KV	1808 MLCC
L1	1186 μ H \pm 35%	----	Common Choke, P/N : PMT-064
L2	4.7 μ H \pm 20%	----	Inductor, P/N: TCK-099

Note : 1. Common mode choke and inductor have been defined and show in page 54.

2. While testing, connect the CASE pin and four screw bolts to shield plane, the EMI could be reduced.

EMI considerations (continued)

These common mode choke have been define as follow :

- TCK-064 Inductance : 1186 μ H \pm 35%
Impedance : 21.56m Ω , max.
Rated current : 5.8A, max.
- TCK-067 Inductance : 620 μ H \pm 35%
Impedance : 25m Ω , max.
Rated current : 7.5A, max.
- TCK-072 Inductance : 156 μ H \pm 35%
Impedance : 15m Ω , max
Rated current : 11.3A, max.
- TCK-073 Inductance : 305 μ H \pm 35%
Impedance : 20m Ω , max.
Rated current : 11.3A, max.

Measurement Instrument (Test condition) :

- L : HP 4263B LCR Meter (100KHz / 100mV)
- DCR : HIOKI 3540 m Ω HITESTER
- IDC : Agilent 34401A Meter

Recommended through hole : Φ 1.0mm

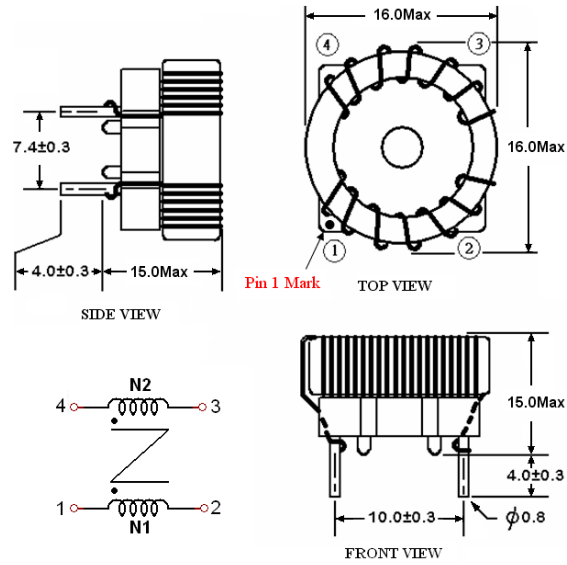

All dimensions in millimeters

The inductor has been defined as follow :

- TCK-099 Inductance : 4.7 μ H \pm 20%
Impedance : 23.3m Ω , typ.
Rated current : 5A, max.

Measurement Instrument (Test condition) :

- L : HP 4263B LCR Meter (100KHz / 250mV)
- DCR : HIOKI 3540 m Ω HITESTER
- IDC : Agilent 34401A Meter

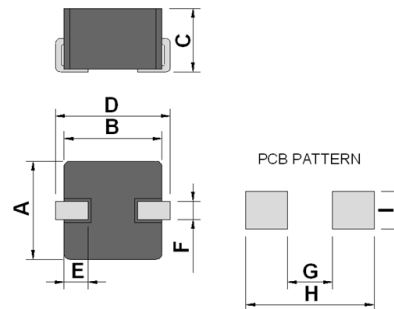

A	B	C	D	E
6.5 \pm 0.3	6.5 \pm 0.3	4.2,max.	7.6,max.	1.6 \pm 0.3
F	G	H	I	
1.2 \pm 0.3	3	8.5	2.5	

All dimensions in mm

Output Voltage Adjustment

Output voltage is adjustable for 10% trim up or -20% trim down of nominal output voltage by connecting an external resistor between the TRIM pin and either the +SENSE or -SENSE pins. With an external resistor between the TRIM and -SENSE pin, the output voltage set point decreases. With an external resistor between the TRIM and +SENSE pin, the output voltage set point increases. Maximum output deviation is +10% inclusive of remote sense. (Please refer to page 57, remote sense) The value of external resistor can be obtained by equation or trim table shown in next page. The external TRIM resistor needs to be at least 1/8W resistors.

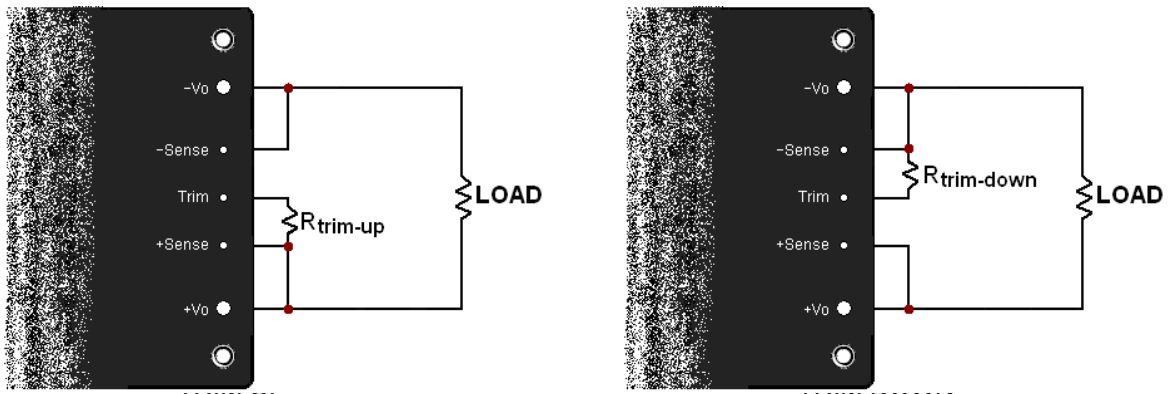

Output Voltage Adjustment (continued)

TRIM EQUATION

$$R_U = \left(\frac{V_{OUT}(100 + \Delta\%)}{1.225\Delta\%} - \frac{100 + 2\Delta\%}{\Delta\%} \right) K\Omega \quad R_D = \left(\frac{100}{\Delta\%} - 2 \right) K\Omega$$

TRIM TABLE

TEP 75-xx10WI

Trim up (%)	1	2	3	4	5	6	7	8	9	10
V _{OUT} (Volts)=	3.333	3.366	3.399	3.432	3.465	3.498	3.531	3.564	3.597	3.630
R _U (K Ohms)=	170.082	85.388	57.156	43.041	34.571	28.925	24.892	21.867	19.515	17.633

TEP 75xx11WI

Trim up (%)	1	2	3	4	5	6	7	8	9	10
V _{OUT} (Volts)=	5.05	5.10	5.15	5.20	5.25	5.30	5.35	5.40	5.45	5.50
R _U (K Ohms)=	310.245	156.163	104.803	79.122	63.714	53.442	46.105	40.602	36.322	32.898

TEP 75-xx12WI

Trim up (%)	1	2	3	4	5	6	7	8	9	10
V _{OUT} (Volts)=	12.12	12.24	12.36	12.48	12.60	12.72	12.84	12.96	13.08	13.20
R _U (K Ohms)=	887.388	447.592	300.993	227.694	183.714	154.395	133.452	117.745	105.528	95.755

TEP 75-xx13WI

Trim up (%)	1	2	3	4	5	6	7	8	9	10
V _{OUT} (Volts)=	15.15	15.30	15.45	15.60	15.75	15.90	16.05	16.20	16.35	16.50
R _U (K Ohms)=	1134.735	572.490	385.075	291.367	235.143	197.660	170.886	150.806	135.188	122.694

TEP 75-xx15WI

Trim up (%)	1	2	3	4	5	6	7	8	9	10
V _{OUT} (Volts)=	24.24	24.48	24.72	24.96	25.20	25.44	25.68	25.92	26.16	26.40
R _U (K Ohms)=	1876.776	947.184	637.320	482.388	389.429	327.456	283.190	249.990	224.168	203.510

TEP 75-xx16WI

Trim up (%)	1	2	3	4	5	6	7	8	9	10
V _{OUT} (Volts)=	28.28	28.56	28.84	29.12	29.40	29.68	29.96	30.24	30.52	30.80
R _U (K Ohms)=	2206.571	1113.714	749.429	567.286	458.000	385.143	333.102	294.071	263.714	239.429

TEP 75-xx18WI

Trim up (%)	1	2	3	4	5	6	7	8	9	10
V _{OUT} (Volts)=	48.48	48.96	49.44	49.92	50.40	50.88	51.36	51.84	52.32	52.80
R _U (K Ohms)=	3855.551	1946.367	1309.973	991.776	800.857	673.578	582.665	514.480	461.447	419.020

All

Trim down (%)	1	2	3	4	5	6	7	8	9	10
RD (K Ohms)=	98.000	48.000	31.333	23.000	18.000	14.667	12.286	10.500	9.111	8.000
Trim down (%)	11	12	13	14	15	16	17	18	19	20
RD (K Ohms)=	7.091	6.333	5.692	5.143	4.667	4.250	3.882	3.556	3.263	3.000

Remote Sense

To minimum the effects of distribution losses by regulating the voltage at the Remote Sense pin. The voltage between the SENSE pin and OUTPUT pin must not exceed 10% of Vout, i.e.

$$[+\text{OUTPUT to } -\text{OUTPUT}] - [+\text{SENSE to } -\text{SENSE}] < 10\% \text{ Vout}$$

The voltage between +OUTPUT and –OUTPUT terminals must not exceed the minimum output overvoltage protection threshold. This limit includes any increase in voltage due to remote sense compensation and trim function.

If not using the remote sense feature to regulate the output at the point of load, then connect +SENSE to +OUTPUT and –SENSE to –OUTPUT.

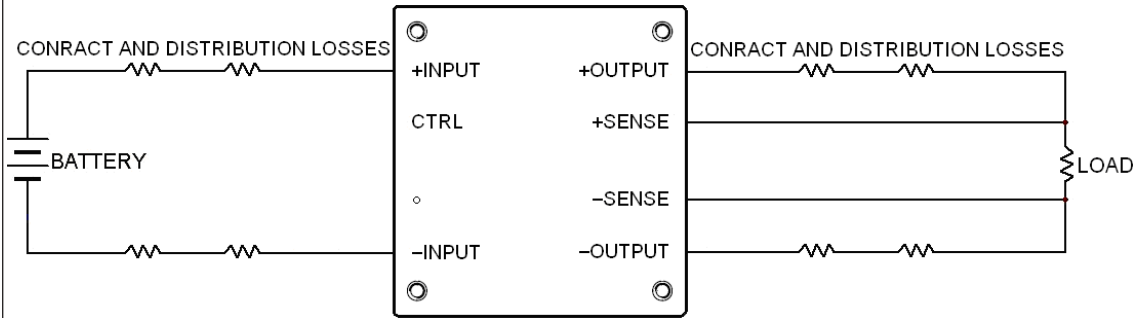

Remote Sense circuit configuration

Input Source Impedance

The power module should be connected to a low impedance input source. Highly inductive source impedance can affect the stability of the power module. Input external π filter is recommended to minimize input reflected ripple current. The inductor is simulated source impedance of 12 μ H and capacitor is Nippon chemi-con KY series 100 μ F/100V. The capacitor must as close as possible to the input terminals of the power module for lower impedance.

Output Over Current Protection

When excessive output currents occur in the system, circuit protection is required on all power supplies. Normally, overload current is maintained at approximately 110~140 percent of rated current for TEP 75WI series.

Hiccup-mode is a method of operation in a power supply whose purpose is to protect the power supply from being damaged during an over-current fault condition. It also enables the power supply to restart when the fault is removed. There are other ways of protecting the power supply when it is over-loaded, such as the maximum current limiting or current foldback methods.

One of the problems resulting from over current is that excessive heat may be generated in power devices, especially MOSFET and Schottky diodes and the temperature of those devices may exceed their specified limits. A protection mechanism has to be used to prevent those power devices from being damaged.

The operation of hiccup is as follows. When the current sense circuit sees an over-current event, the controller shuts off the power supply for a given time and then tries to start up the power supply again. If the over-load condition has been removed, the power supply will start up and operate normally, otherwise, the controller will see another over-current event and shut off the power supply again, repeating the previous cycle. Hiccup operation has none of the drawbacks of the other two protection methods, although its circuit is more complicated because it requires a timing circuit. The excess heat due to overload lasts for only a short duration in the hiccup cycle, hence the junction temperature of the power devices is much lower.

The hiccup operation can be done in various ways. For example, one can start hiccup operation any time an over-current event is detected, or prohibit hiccup during a designated start-up is usually larger than during normal operation and it is easier for an over-current event is detected, or prohibit hiccup during a designated start-up interval (usually a few milliseconds). The reason for the latter operation is that during start-up, the power supply needs to provide extra current to charge up the output capacitor. Thus the current demand during start-up is usually larger than during normal operation and it is easier for an over-current event to occur. If the power supply starts to hiccup once there is an over-current, it might never start up successfully. Hiccup mode protection will give the best protection for a power supply against over current situations, since it will limit the average current to the load at a low level, so reducing power dissipation and case temperature in the power devices.

Short Circuitry Protection

Continuous, hiccup and auto-recovery mode.

During short circuit, converter still shut down. The average current during this condition will be very low and the device can be safety in this condition.

Output Over Voltage Protection

The output over-voltage protection consists of circuitry that monitors the voltage on the output terminals. If the voltage on the output terminals exceeds the over-voltage protection threshold, then the module enter the non-latch hiccup mode.

Over Temperature Protection

Sufficient cooling is needed for the power module and provides more reliable operation of the unit. If a fault condition occurs, the temperature of the unit will be higher. And will damage the unit. For protecting the power module, the unit includes over-temperature protection circuit. When the temperature of the case is to the protection threshold, the unit enters "Hiccup" mode. And it will auto restart when the temperature is down.

Thermal Consideration

The power module operates in a variety of thermal environments. However, sufficient cooling should be provided to help ensure reliable operation of the unit. Heat is removed by conduction, convection, and radiation to the surrounding Environment. Proper cooling can be verified by measuring the point as the figure below. The temperature at this location should not exceed 105 C°. When Operating, adequate cooling must be provided to maintain the test point temperature at or below 105 C°. Although the maximum point Temperature of the power modules is 105 C°, you can limit this Temperature to a lower value for extremely high reliability.

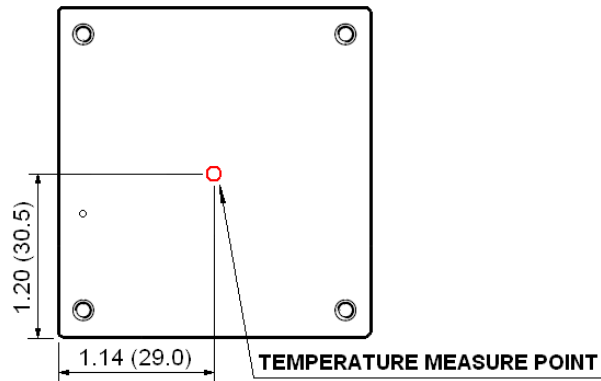

TOP VIEW Measurement shown in inches (mm)

Heat-Sink Considerations

Equip heat-sink for lower temperature and higher reliability of the module. Considering space and air-flow and choose which heat-sink is needed.

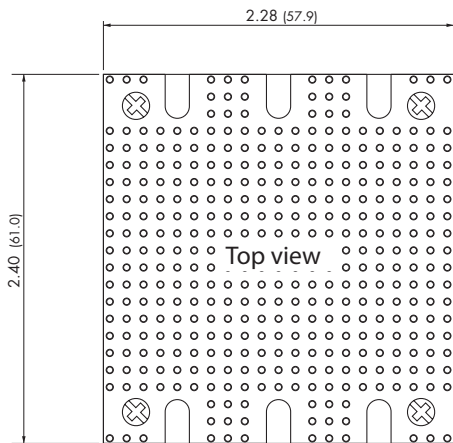
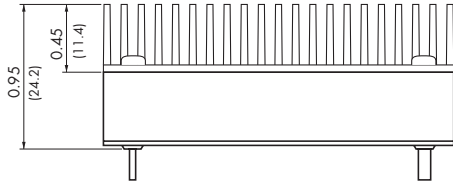

Order code: TEP-HS1

Includes heatsink with thermal pad and mounting screws
To order modules with mounted heatsink ask factory.

Weight: 135g (4.76 oz)
(Heatsink + Converter)

Dimensions in Inch, () = mm
Tolerances ± 0.02 (± 0.5)
Pin pitch tolerances ± 0.01 (± 0.25)
Mounting hole pitch tolerances ± 0.01 (± 0.25)

Remote ON/OFF Control

The CTRL pin is controlled DC/DC power module to turn on and off, the user must use a switch to control the logic voltage high or low level of the pin referenced to -INPUT. The switch can be open collector transistor, FET and Photo-Couple. The switch must be capable of sinking up to 1 mA at low-level logic voltage. High-level logic of the CTRL pin signal maximum voltage is allowable leakage current of the switch at 12V is 0.5 mA.

Remote ON/OFF Implementation Circuits

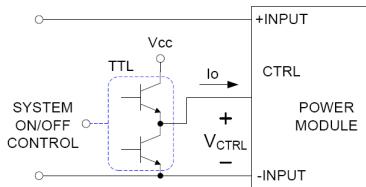

Isolated-Closure Remote ON/OFF

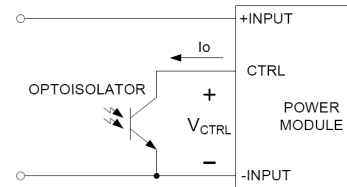

Level Control Using TTL Output

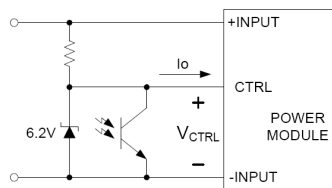

Level Control Using Line Voltage

There are two remote control options available, positive logic and negative logic.

a. The Positive logic structure turned on of the DC/DC module when the CTRL pin is at high-level logic and low-level logic is turned off it.

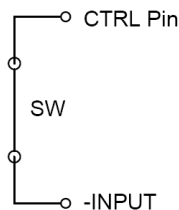

When TEP 75WI module is turned off at Low-level logic

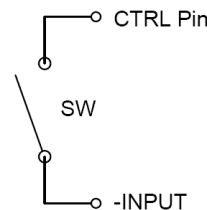

When TEP 75WI module is turned on at High-level logic

b. The Negative logic structure turned on of the DC/DC module when the CTRL pin is at low-level logic and turned off when at high-level logic.

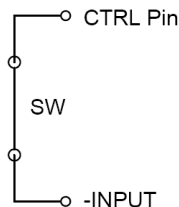

When TEP 75WI module is turned on at Low-level logic

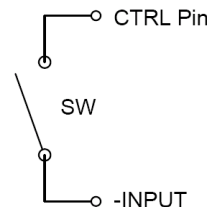

When TEP 75WI module is turned off at High-level logic

Mechanical Data Of The Standard Product

TEP 75WI module

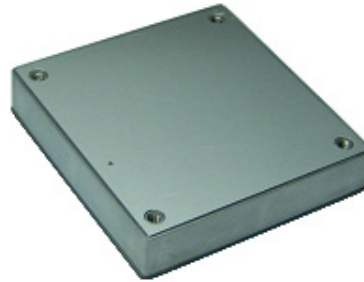
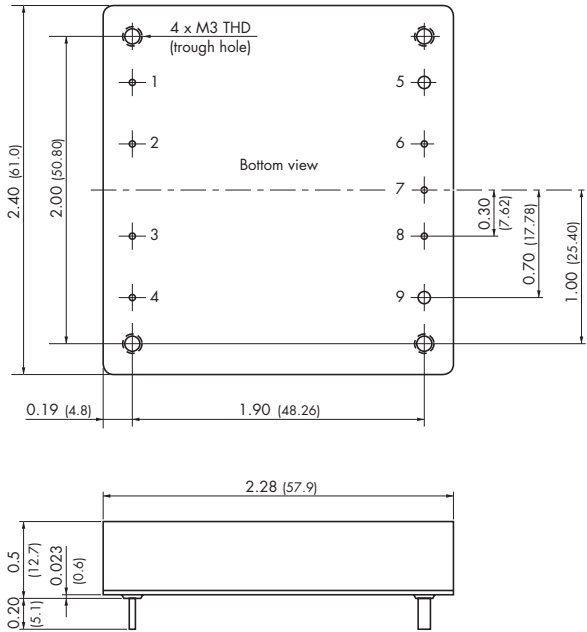

Weight: 97g (3.42 oz)

Pin diameter pin 5 & 9: 0.08 (2.0)
Pin diameter other pins: 0.04 (1.0)

Pin-Out

Pin	
1	- Vin
2	Case
3	Remote On/Off
4	+ Vin
5	- Vout
6	- Sense*
7	Trim
8	+ Sense*
9	+ Vout

*Sense line to be connected to the output either at the module or at the load under regard of polarity.

Mechanical Data Of The Terminal Block Type**TEP 75 module with chassis mount adaptor (suffix -CM or -CMF)**

For easy chassis mounting the converter modules can be supplied with an adaptor option consisting of a screw terminal connection board (soldered to converter pins) and a chassis mount adaptor.

In addition this Chassis mount option is available with an EMI-filter (see EMI specification)

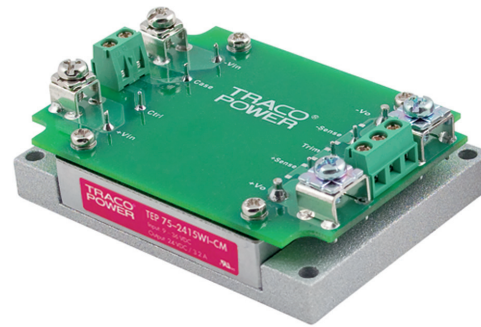
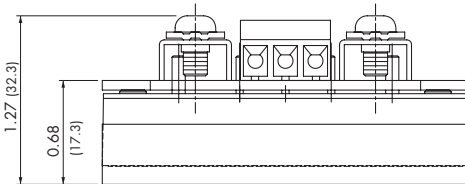
Suffix -CM: Chassis mount adaptor

Weight: -CM 196 g (6.91 oz)

Mechanical Data Of The Terminal Block Type (continued)

TEP 75 module with chassis mount adaptor

For easy chassis mounting the converter modules can be supplied with an adaptor option consisting of a screw terminal connection board (soldered to converter pins) and a chassis mount adaptor. In addition this Chassis mount option is available with an EMI-filter (see EMI specification)

Suffix -CMF: Chassis mount adaptor with EMI filter

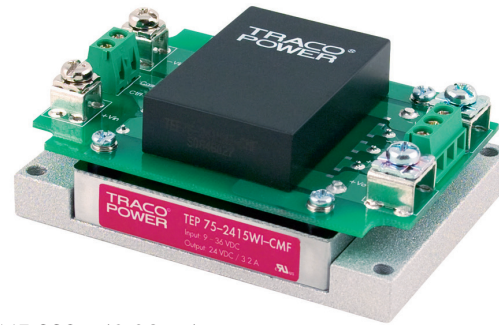
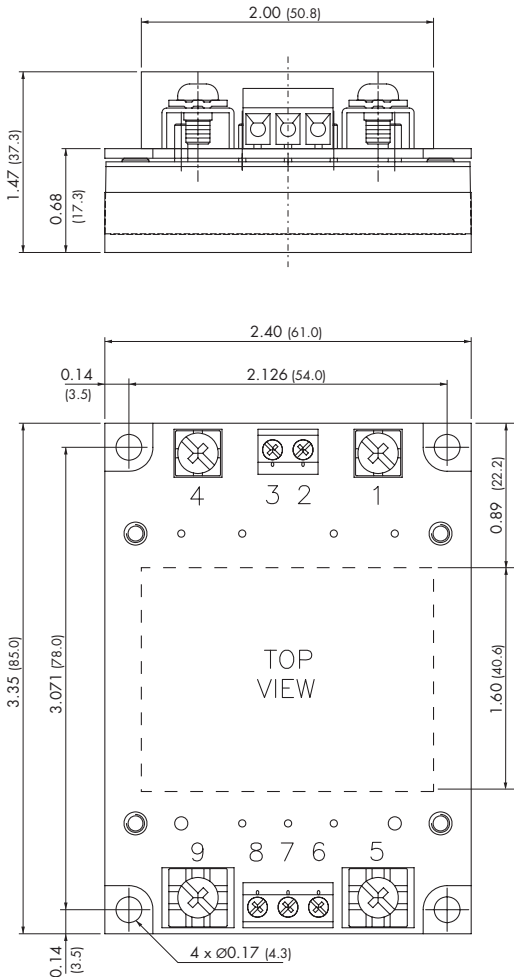

Weight: -CMF 238 g (8.39 oz)

Please note that adaptors cannot be ordered as separate items but are factory assembled.

Pin	Connection
1	-Vin
2	Case
3	Remote On/Off
4	+Vin
5	-Vout
6	-Sense*
7	Trim
8	+Sense*
9	+Vout

Dimensions in Inch, () = mm
Tolerances ± 0.02 (± 0.5)
Mounting hole pitch tolerances ± 0.01 (± 0.25)

*Sense line to be connected to the output either at the module or at the load under regard of polarity.

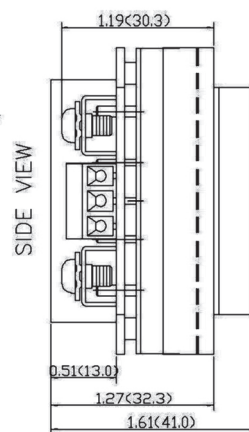
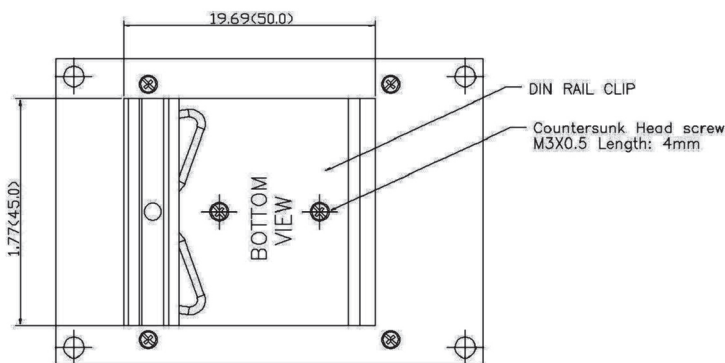

Order code: TEP-MK1

Includes DIN-rail clip and mounting screws.
To order modules with mounted DIN-rail clip ask factory.

Recommended Pad Layout

All dimensions in inch (mm)

Tolerances : x.xxx ± 0.010 (x.xx ± 0.25)

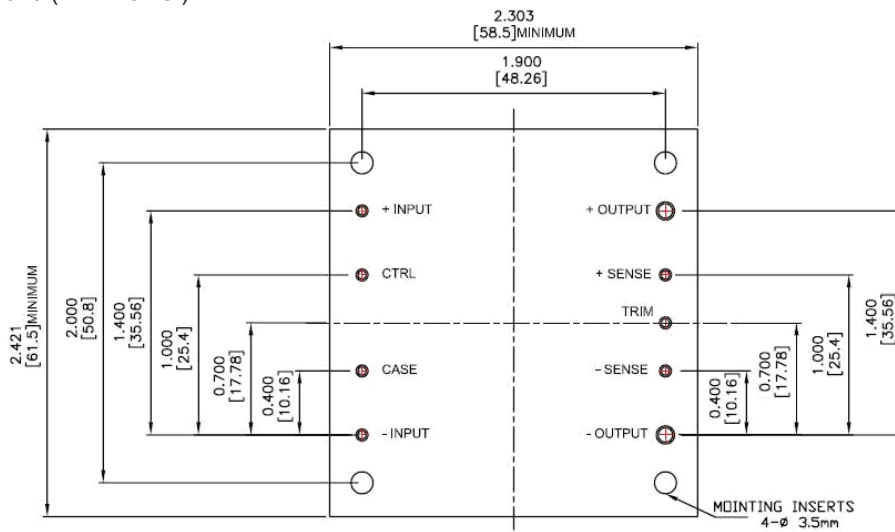

PAD SIZE (LEAD FREE RECOMMENDED)

+/- OUTPUT :

- THROUGH HOLE : Ø 2.3mm
- TOP VIEW PAD : Ø 2.9mm
- BOTTOM VIEW PAD : Ø 3.6mm

OTHERS :

- THROUGH HOLE : Ø 1.3mm
- TOP VIEW PAD : Ø 1.9mm
- BOTTOM VIEW PAD : Ø 2.6mm

Soldering Considerations

Lead free wave solder profile for TEP 75WI series

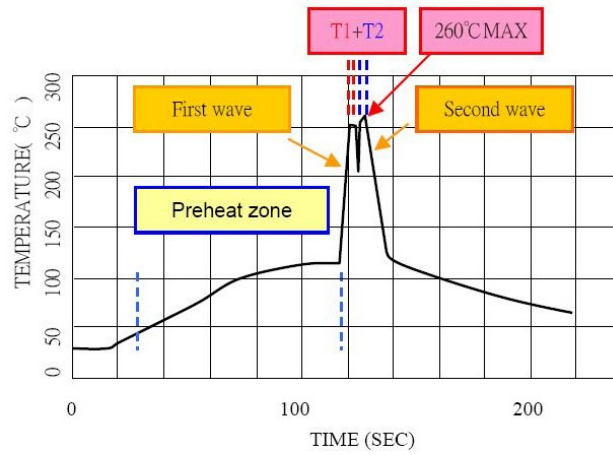

Zone	Reference Parameter
Preheat zone	Rise temp. speed : 3C°/sec max. Preheat temp. : 100~130C°
Actual heating	Peak temp. : 250~260C° Peak time (T1+T2 time) : 4~6 sec

Reference Solder : Sn-Ag-Cu , Sn-Cu

Hand Welding :

Soldering iron : Power 90W

Welding Time : 2~4 sec

Temp. : 380~400C°

Packaging Information

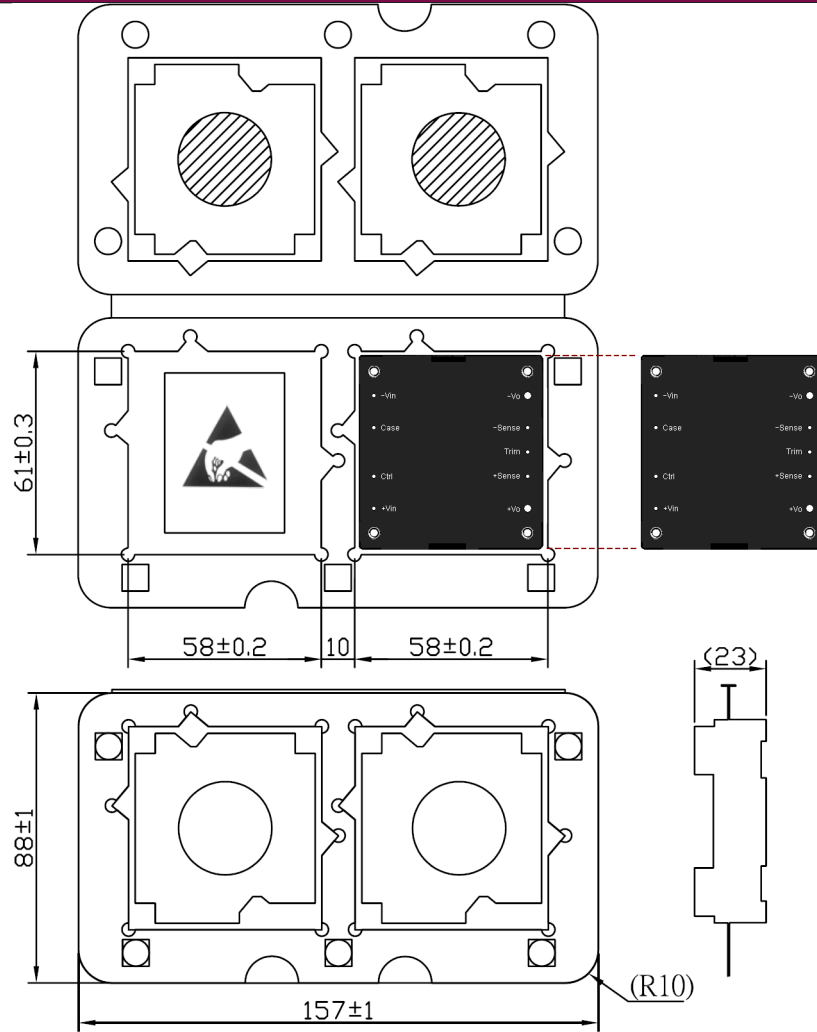

Dimensions shown in millimeters

Part Number Structure

TEP 75-4812WI

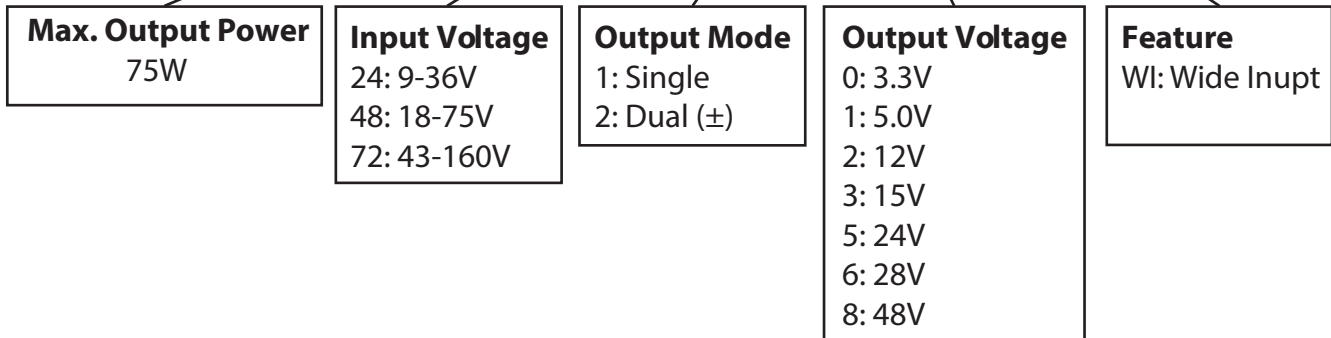

Model Number	Input Range	Output Voltage	Output Current max.load	No load Input Current	Efficiency (%)
TEP 75-2410WI	9 ~ 36 VDC	3.3VDC	20 A	85mA	87
TEP 75-2411WI	9 ~ 36 VDC	5VDC	15 A	120mA	88
TEP 75-2412WI	9 ~ 36 VDC	12VDC	6.3 A	185mA	88
TEP 75-2413WI	9 ~ 36 VDC	15VDC	5 A	185mA	88
TEP 75-2415WI	9 ~ 36 VDC	24VDC	3.2 A	85mA	87
TEP 75-2416WI	9 ~ 36 VDC	28VDC	2.7 A	85mA	87
TEP 75-2418WI	9 ~ 36 VDC	48VDC	1.6 A	85mA	87
TEP 75-4810WI	18 ~ 75 VDC	3.3VDC	20 A	60mA	88
TEP 75-4811WI	18 ~ 75 VDC	5VDC	15 A	60mA	90
TEP 75-4812WI	18 ~ 75 VDC	12VDC	6.3 A	90mA	90
TEP 75-4813WI	18 ~ 75 VDC	15VDC	5 A	50mA	89
TEP 75-4815WI	18 ~ 75 VDC	24VDC	3.2 A	50mA	88
TEP 75-4816WI	18 ~ 75 VDC	28VDC	2.7 A	50mA	88
TEP 75-4818WI	18 ~ 75 VDC	48VDC	1.6 A	50mA	87
TEP 75-7210WI	43 ~ 160 VDC	3.3VDC	20 A	10mA	89
TEP 75-7211WI	43 ~ 160 VDC	5VDC	15 A	10mA	91
TEP 75-7212WI	43 ~ 160 VDC	12VDC	6.3 A	10mA	91
TEP 75-7213WI	43 ~ 160 VDC	15VDC	5 A	10mA	91
TEP 75-7215WI	43 ~ 160 VDC	24VDC	3.2 A	10mA	90
TEP 75-7216WI	43 ~ 160 VDC	28VDC	2.7 A	10mA	90
TEP 75-7218WI	43 ~ 160 VDC	48VDC	1.6 A	10mA	90

Note 1. Typical value at nominal input and no load.

Note 2. Typical value at nominal input and full load.

Safety and Installation Instruction

The TEP 75WI series has built in the protection function of the polarity reverse as the following figure.

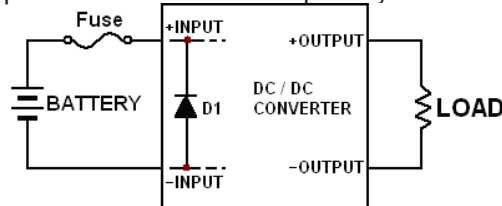

Fusing Consideration

Caution: This power module is not internally fused. An input line fuse must always be used.

This encapsulated power module can be used in a wide variety of applications, ranging from simple stand-alone operation to an integrated part of sophisticated power architecture. To maximum flexibility, internal fusing is not included, however, to achieve maximum safety and system protection, always use an input line fuse. The safety agencies require a slow-blow fuse with maximum rating of 15A for TEP 75-24xxWI, 8A for TEP 75-48xxWWI and 3.5A for TEP 75-72xxWI. Based on the information provided in this data sheet on Inrush energy and maximum dc input current, the same type of fuse with lower rating can be used. Refer to the fuse manufacturer's data for further information.

MTBF and Reliability

The MTBF of TEP 75WI series DC/DC converters has been calculated using

Bellcore TR-NWT-000332 Case I: 50% stress, Operating Temperature at 40C° (Ground fixed and controlled environment). The resulting figure for MTBF is 1.010x10⁶ hours.

MIL-HDBK 217F NOTICE2 FULL LOAD, Operating Temperature at 25C°. The resulting figure for MTBF is 7.416x10⁴ hours.