

Watertight Distribution Enclosures IP65 - GCUT8



The IP65 boxes have a completely new and innovative shape, reaching the highest level of quality and design.

They are made from halogen free long-lasting thermoplastic materials, ABS and polycarbonate. They have lots of space for wiring and also the possibility to place the Din rail in two height positions. Mounting plates and other accessories can be installed on the base inside.

Doors are transparent and hinged, opening to 180°. Transparent doors are UV protected. The four screws linking base and frame are sealable.

As accessories there are earth and neutral bars in double height possible, section 12x 6,5 mm. in order to reach 125A of permissible intensity.

Apart from the standard locking system, key-locks and triangle locks are also offered as accessories. Modular capacity from 4 up to 54.

Information on Enclosure

- Type: 1x8 modules DIN rail
- Cable entries sup.: 4xM25 + 1xM40
- Inf.: 4xM25 + 1xM40
- Oblong back: 2xOB25_25

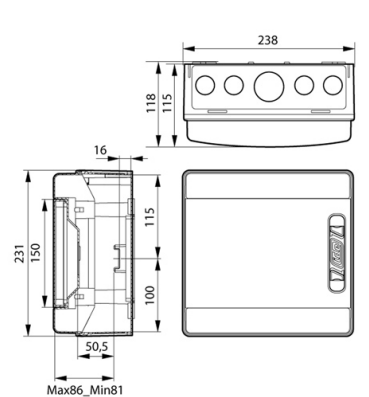

Technical Data

- Degree of Protection: IP65
- Resistance to Impact: IK08
- Auto-extinguishing degree: HB (UL94)
- Test of resistance to glow wire: 650° C
- Ball Pressure Test: 70° C
- Range of temperature under normal conditions: -25°C - +40°C
- Halogen free materials
aBs and polycarbonate

According to 2006-95-CE directive and EN60439-1 and UNE-EN 60439-3 norms on affected parts.