

Features

ICE Technology*

- Up to 90°C ambient, no derating
- 120°C Maximum Case Temperature
- -45°C Minimum Temp. (optional: -55°C)
- Built-in FCC/EN55022 Class B Filter
- 4:1 Wide Input Voltage Range
- Six Sided Shielded Enclosure
- Ribbed, Flat or Baseplate Case Styles
- Efficiency to >89%
- 3kVDC Isolation
- Fully Protected
- Low Quiescent Current

Description

The RPP30-W series 4:1 input range DC/DC converters are ideal for high end industrial applications and COTS Military applications where a very wide operating temperature range of -45°C to +120°C is required. The converters are also optionally available with a -55°C start-up temperature. Although the case size is compact, the converter contains a built-in filter EN55022 Class B / FCC Level B without the need for any external components. The RPP30-W is available in three case styles: the high operating temperature ribbed case, the low profile flat case and the baseplate case for high vibration or bulkhead-mounting applications. They are UL-60950-1 certified.

Selection Guide 24V and 48V 4:1 Input Types

Part Number	Input Range VDC	Output Voltage VDC	Output Current mA	Input ⁽¹⁾ Current mA	Efficiency ⁽²⁾ (Typ.)	Max ⁽³⁾ Ambient Temp
RPP30-243.3SW	9-36	3.3	8400	57/1326	87.1%	85°C
RPP30-2405SW	9-36	5	6000	62/1397	89.5%	89°C
RPP30-2412SW	9-36	12	2500	27/1420	88.0%	85°C
RPP30-2415SW	9-36	15	2000	31/1436	89.7%	90°C
RPP30-2424SW	9-36	24	1250	31/1436	89.7%	90°C
RPP30-483.3SW	18-75	3.3	9000	46/704	87.6%	84°C
RPP30-4805SW	18-75	5	6000	38/710	89.7%	90°C
RPP30-4812SW	18-75	12	2500	15/727	87.8%	85°C
RPP30-4815SW	18-75	15	2000	19/718	89.3%	89°C
RPP30-4824SW	18-75	24	1250	19/718	89.3%	89°C
RPP30-2412DW	9-36	±12	±1250	32/1453	89.2%	89°C
RPP30-2415DW	9-36	±15	±1000	30/1436	87.2%	85°C
RPP30-2424DW	9-36	±24	±625	30/1436	87.2%	85°C
RPP30-4812DW	18-75	±12	±1250	18/727	87.5%	85°C
RPP30-4815DW	18-75	±15	±1000	20/718	89.1%	89°C
RPP30-4824DW	18-75	±24	±625	20/718	89.1%	89°C

** add suffixes for case, temperature or CTRL logic options.

Derating Graph (Ambient Temperature)

RPP30-4805SW

Derating graphs are valid only for the shown part number. Please contact Technical Support for more information: info@recom-development.att

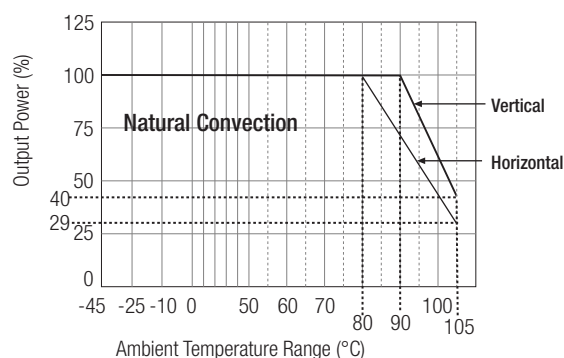

POWERLINE+

DC/DC-Converter

with 3 year Warranty

RECOM

30 Watt

4:1 Single & Dual Output

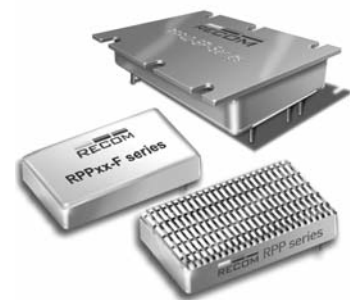

UL-60950-1 Certified
E224736

RPP30-W

SUFFIX INFORMATION

none = Standard Ribbed Case
 -B = Baseplate Case
 -F = Flat Case
 -L = Low Temp (-55°C) Ribbed Case
 -M = Low Temp (-55°C) Baseplate Case
 -T = Low Temp (-55°C) Flat Case

add "1" before suffix for neg. CTRL logic
 e.g. -1, -1B, -1F, etc.

* ICE Technology

ICE (Innovation in Converter Excellence) uses state-of-the-art techniques to minimise internal power dissipation and to increase the internal temperature limits to extend the ambient operating temperature range to the maximum. Refer to Application Notes

POWERLINE+

DC/DC-Converter

RPP30-S_DW Series

Specifications (typical at nominal input and 25°C unless otherwise noted)

Input Voltage Range	24V nominal input	9-36VDC	
	48V nominal input	18-75VDC	
Under Voltage Lockout	24V input	DC-DC ON (min.)	8.5VDC
		DC-DC OFF (max.)	8VDC
	48V input	DC-DC ON (min.)	17.5VDC
		DC-DC OFF (max.)	17VDC
Input Filter	Common Mode EMC Filter		
Input Voltage Variation dv/dt (Complies with ETS300 132 part 4.4)	5V/ms max		
Input Surge Voltage (100 ms max.)	24V Input	50VDC	
	48V Input	100VDC	
Input Reflected Ripple	nominal Vin and full load	30mAp-p	
Start Up Time	nominal Vin and constant resistor load	2ms typ., 5ms max.	
Remote ON/OFF ⁽⁴⁾	Logic High	Open or 3.0V < Vr < 5.5V	
	Logic Low	Short or 0V < Vr < 1.2V	
Remote OFF input current	Nominal input	2mA typ.	
Output Power	30W max.		
Output Voltage Accuracy	50% Load and nominal Vin	±1.5%	
Voltage Adjustability	Single Output only	±5%	
Minimum Load	0%		
Line Regulation	low line, high line at full load	±0.3%	
Load Regulation	10% to 100% full load	±0.5%	
Cross Regulation (10% <> 100% Load)	Dual Outputs only	3% typ./ 5% max.	
Ripple and Noise (20MHz bandwidth limited) (measured with 1µF capacitor across outputs)	3.3V, 5V	80mVp-p typ.	
	All others	27mV-60mVp-p max	
Temperature Coefficient	±0.04%/°C max.		
Transient Response	25% load step change	800µs	
Over Load Protection	% of full load at nominal Vin	120% typ.	
Short Circuit Protection	hiccup, automatic recovery		
Output Over Voltage Protection (refer to block diagram in Application Notes)	Converter shutdown if Vout > Vout nominal +20%		
Isolation Voltage	Rated at 2250VDC/1 minute, Flash tested at 3000VDC/1 second		
Isolation Resistance	10MΩ min.		
Isolation Capacitance (refer to block diagram in Application Notes)	3000pF max.		
Operating Frequency	300kHz ± 30kHz		
Operating Temperature Range	Ambient, Free Convection	-45°C to +90°C max (without derating)	
		-45°C to +105°C max (with derating)	
	-55°C Version	-55°C to +90°C (without derating)	
Maximum Case Temperature	+120°C		
Storage Temperature Range	-55°C to +125°C		
Over Temperature Protection (refer to block diagram in Application Notes)	internal thermistor		
Thermal Impedance (Natural convection)	Ribbed Case: Vertical	7.3°C/Watt	
	Ribbed Case: Horizontal	10°C/Watt	
Relative Humidity	5% to 95% RH		
Case Material ⁽⁷⁾	Aluminium		
Potting Material	Silicone (UL94-V0)		
Weight	Ribbed Case	39g	
	Flat Case	34g	
	Basplate Case	43g	

Specifications (typical at nominal input and 25°C unless otherwise noted)

Packing Quantity	Ribbed and Flat Case Baseplate Case	4 pcs per Tube Single Packed
Safety Standards		certified UL-60950-1, 1st Edition
Thermal Cycling		complies with MIL-STD-810F
Vibration		10-55Hz, 12G, 30 Min. along X, Y and Z
Conducted Emissions	EN55022	Class B
Radiated Emissions	EN55022	Class B
ESD	EN61000-4-2	Perf. Criteria B
Radiated Immunity	EN61000-4-3	Perf. Criteria A
Fast Transient ⁽⁵⁾	EN61000-4-4	Perf. Criteria B
Surge ⁽⁵⁾	EN61000-4-5	Perf. Criteria B
Conducted Immunity	EN61000-4-6	Perf. Criteria A
MTBF calculated according to BELLCORE TR-NWT-000332 ⁽⁶⁾		2195 x 10 ³ hours

Notes :

1. Typical values at nominal input voltage and no load/full load.
2. Typical values at nominal input voltage and full load.
3. Typical values at nominal input voltage and full load in vertical orientation and with Eurocard-sized PCB ground planes to assist in heat dissipation.
For horizontal orientation, reduce the maximum temperatures by 10°C.
4. The ON/OFF pin voltage is referenced to negative input. The pin is pulled high internally.
ON/OFF control is standard with positive logic: e.g. RPP30-2405SW, RPP30-4805DW-B.
Add "1" before the suffix for negative logic: e.g. RPP30-2405SW-1, RPP30-4805DW-1B.
Positive logic: 0= OFF, 1 = ON. The converter will be ON if the CTRL is left open.
Negative logic: 1 = OFF, 0 = ON. The converter will be OFF if the CTRL is left open.
5. Requires an external 100µF low ESR capacitor to meet EN61000-4-4 and EN61000-4-5
6. Case I: 50% Stress, Temperature at 50°C (Ground Benign).
7. To ensure a good all-round electrical contact, the baseplate is pressed firmly into place within the aluminium housing. The hydraulic press can leave tooling marks and deformations to both the housing and baseplate. The case is anodised aluminium, so there will be natural variations in the case colour and the aluminium is not scratch resistant. Any resultant marks, scratches and colour variations are cosmetic only and do not affect the operation or performance of the converters.

External Output Trimming

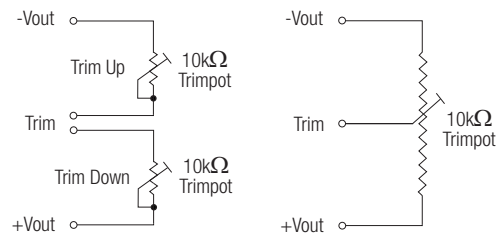

RPP30-4805SW

Efficiency VS Input Voltage

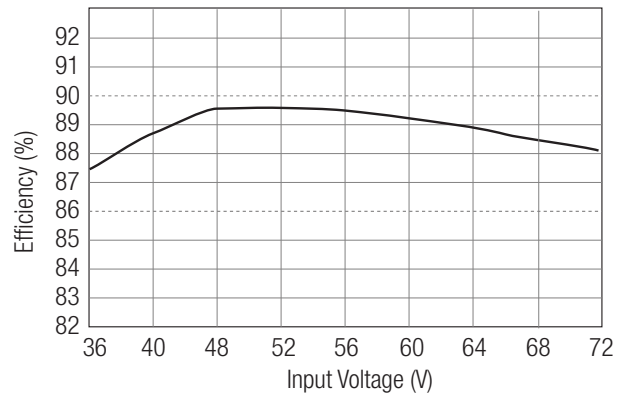

Recommended PCB Layout

Single Output

Dual Output

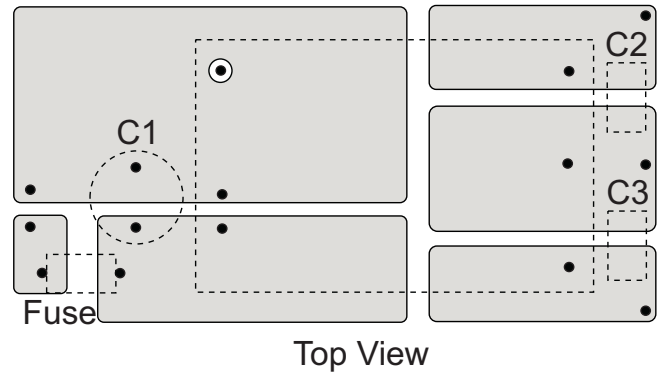
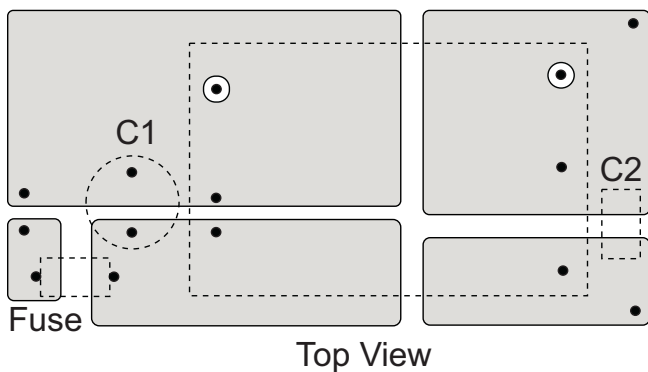

Baseplate Case- suggested PCB layout

Single Output

Dual Output

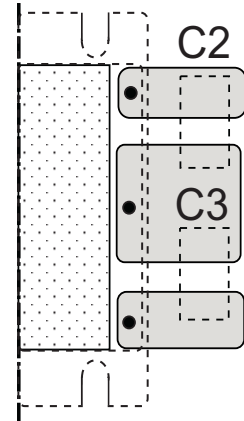
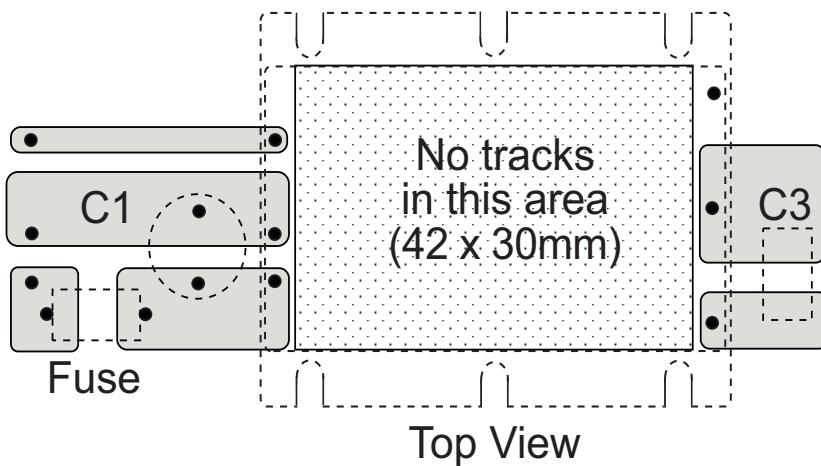

Input Fuse is recommended, but optional. Recommended fuse rating = double maximum input current, time delay type.

Input Capacitor, C1, is required to meet EN61000 Surge and Fast Transient, otherwise it is not required for normal operation.

Output Capacitors C2/C3 are recommended, but not required for normal operation. Typical capacitor values are 1µF MLCC

To ensure optimum thermal performance, use large areas of copper on the PCB to assist with heat dissipation and mount the converter vertically.

POWERLINE+

DC/DC-Converter

RPP30-S_DW Series

Package Style and Pinning (mm)

Ribbed Case (Standard - no Suffix)

(Low temperature version = suffix -L)

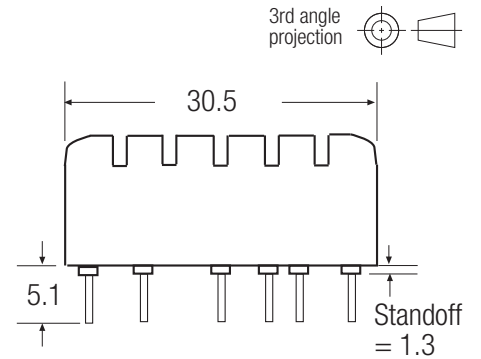
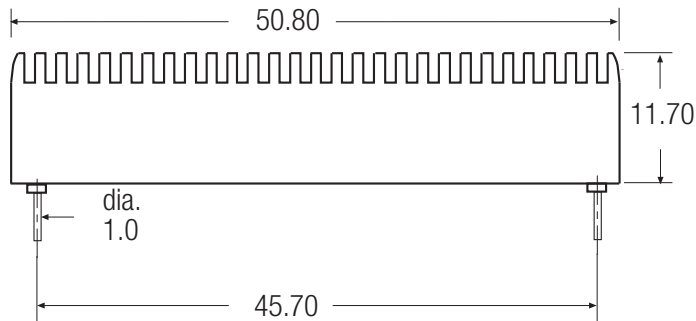

3rd angle projection

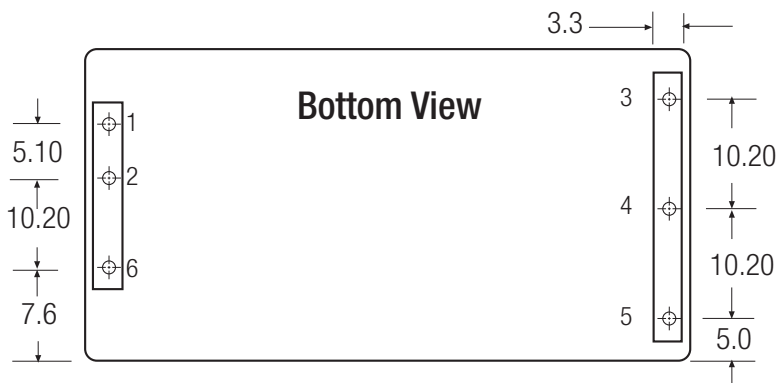

Pin Connections

Pin #	Single	Dual
1	+Vin	+Vin
2	-Vin	-Vin
3	+Vout	+Vout
4	-Vout	Com
5	Trim	-Vout
6	CTRL	CTRL

Pin Pitch Tolerance ± 0.35 mm

Flat Case (-F Suffix)

(Low temperature version = suffix -T)

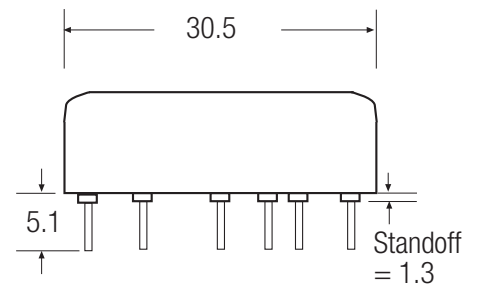
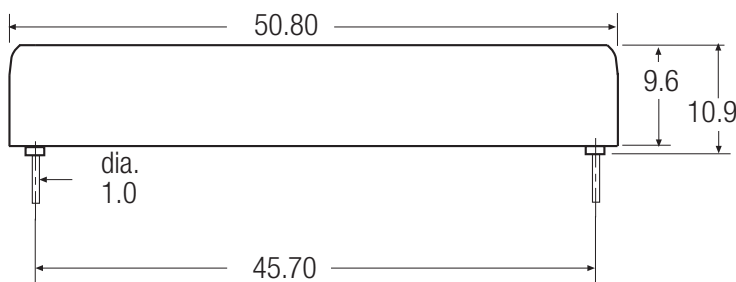

3rd angle projection

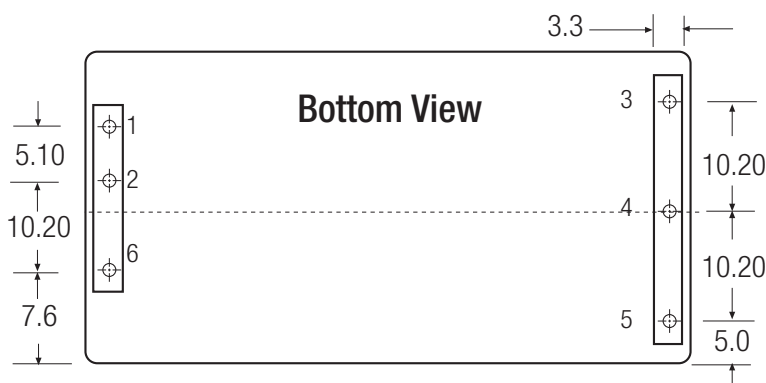

Pin Connections

Pin #	Single	Dual
1	+Vin	+Vin
2	-Vin	-Vin
3	+Vout	+Vout
4	-Vout	Com
5	Trim	-Vout
6	CTRL	CTRL

Pin Pitch Tolerance ± 0.35 mm

RPP30-W

RPP30-S_DW Series

POWERLINE+

DC/DC-Converter

Package Style and Pinning (mm)

Baseplate Case (-B Suffix)
(Low temperature version = suffix -M)

3rd angle projection 

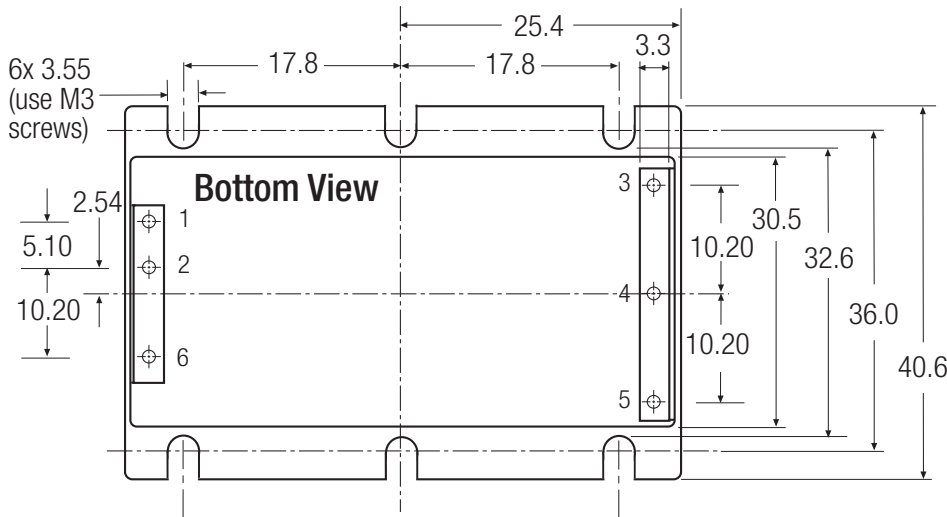
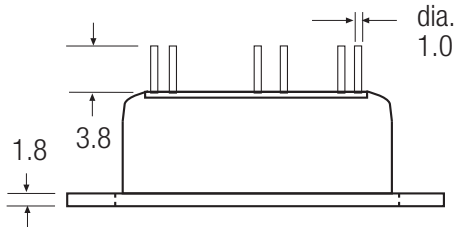
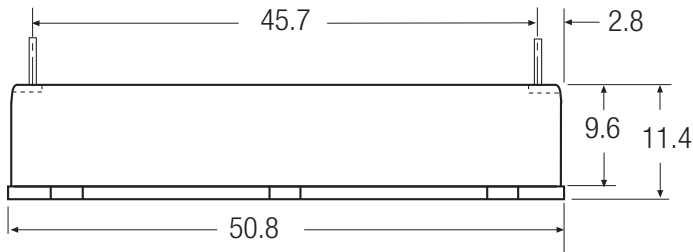

Pin Connections

Pin #	Single	Dual
1	+Vin	+Vin
2	-Vin	-Vin
3	+Vout	+Vout
4	-Vout	Com
5	Trim	-Vout
6	CTRL	CTRL

Pin Pitch Tolerance ± 0.35 mm

RPP30-W

Baseplate Case Fixing - Mounting onto Heatsink/Bulkhead

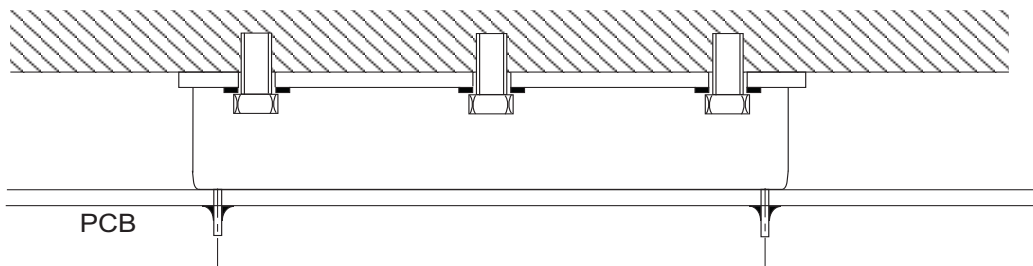

Baseplate Case Fixing - Anti Vibration Mounting onto PCB

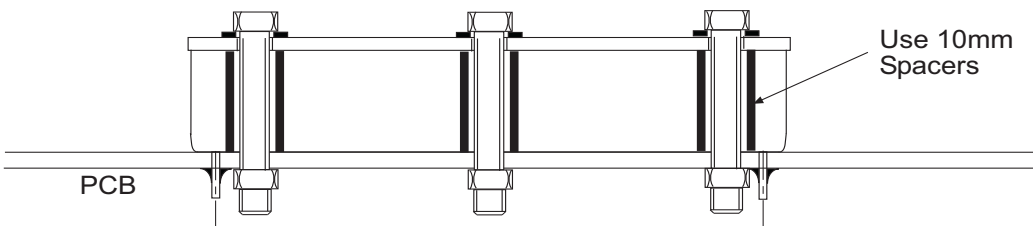

Use 10mm Spacers