

# ELECTRONIC SNAP CIRCUITS®

## Experiments 1-101

AGE  
8 - 108

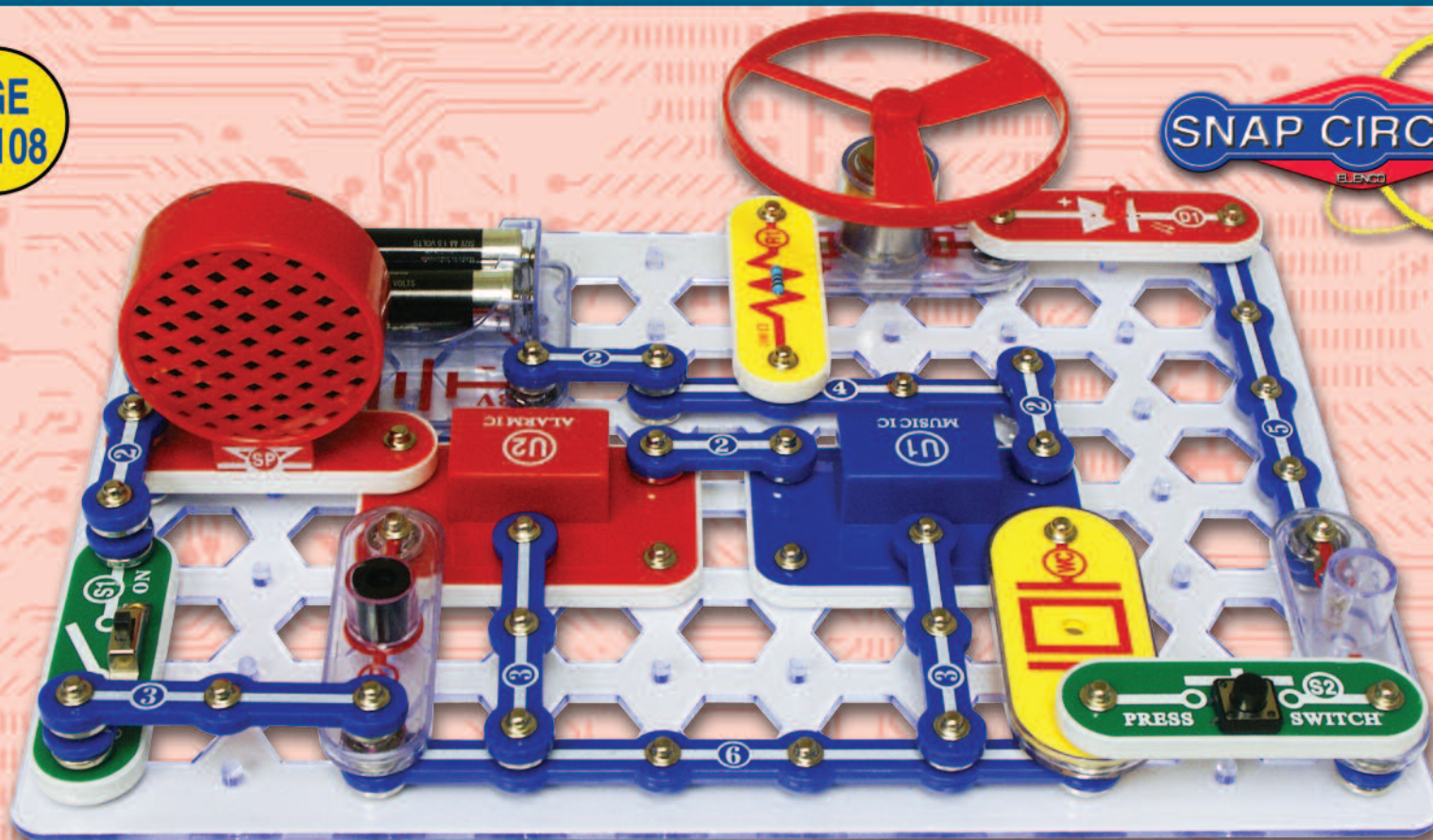

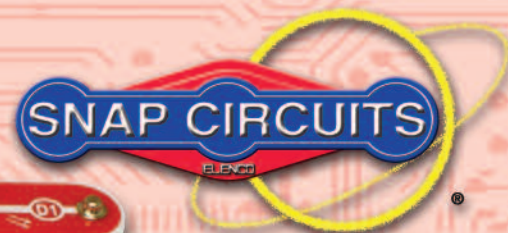

Instruction Manual

Project 58

ELENCO®

## Table of Contents

Basic Troubleshooting	1	Advanced Troubleshooting	6
Parts List	2	Project Listings	7
How to Use It	3	Projects 1 - 101	8 - 44
About Your Snap Circuits® Parts	4	Other Snap Circuits® Projects	45
DOs and DON'Ts of Building Circuits	5	Snap Circuits® Project Shapes	46

 **WARNING FOR ALL PROJECTS WITH A  SYMBOL** - Moving parts. Do not touch the motor or fan during operation. Do not lean over the motor. Do not launch the fan at people, animals, or objects. Eye protection is recommended. 

 **WARNING: SHOCK HAZARD** - Never connect Snap Circuits® to the electrical outlets in your home in any way!

 **WARNING: CHOKING HAZARD** - Small parts. Not for children under 3 years.

Conforms to all applicable U.S. government requirements and CAN ICES-3 (B)/NMB-3 (B).

## Basic Troubleshooting

1. Most circuit problems are due to incorrect assembly, always double-check that your circuit exactly matches the drawing for it.
2. Be sure that parts with positive/negative markings are positioned as per the drawing.
3. Be sure that all connections are securely snapped.
4. Try replacing the batteries.
5. If the motor spins but does not balance the fan, check the black plastic piece with three prongs on the motor shaft. Be sure that it is at the top of the shaft.

Elenco® is not responsible for parts damaged due to incorrect wiring.

**Note:** If you suspect you have damaged parts, you can follow the Advanced Troubleshooting procedure on page 6 to determine which ones need replacing.

**WARNING:** Always check your wiring before turning on a circuit. Never leave a circuit unattended while the batteries are installed. Never connect additional batteries or any other power sources to your circuits. Discard any cracked or broken parts.

**Adult Supervision:** Because children's abilities vary so much, even with age groups, adults should exercise discretion as to which experiments are suitable and safe (the instructions should enable supervising adults to

establish the experiment's suitability for the child). Make sure your child reads and follows all of the relevant instructions and safety procedures, and keeps them at hand for reference.

This product is intended for use by adults and children who have attained sufficient maturity to read and follow directions and warnings.

Never modify your parts, as doing so may disable important safety features in them, and could put your child at risk of injury.

### Batteries:

- Use only 1.5V AA type, alkaline batteries (not included).
- Insert batteries with correct polarity.
- Non-rechargeable batteries should not be recharged. Rechargeable batteries should only be charged under adult supervision, and should not be recharged while in the product.
- Do not mix old and new batteries.





















- Do not connect batteries or battery holders in parallel.
- Do not mix alkaline, standard (carbon-zinc), or rechargeable (nickel-cadmium) batteries.
- Remove batteries when they are used up.
- Do not short circuit the battery terminals.
- Never throw batteries in a fire or attempt to open its outer casing.
- Batteries are harmful if swallowed, so keep away from small children.



## Parts List (Colors and styles may vary) Symbols and Numbers

**Note:** If you have the more advanced Models SC-300, SC-500, or SC-750, there are additional part lists in the other project manuals.

**Important:** If any parts are missing or damaged, **DO NOT RETURN TO RETAILER.** Call toll-free (800) 533-2441 or e-mail us at: help@elenco.com. Customer Service #150 Carpenter Ave. #Wheeling, IL 60090 U.S.A.

Qty.	ID	Name	Symbol	Part #	Qty.	ID	Name	Symbol	Part #
☐ 1		Base Grid (11.0" x 7.7")		6SCBG	☐ 1	(D1)	Red Light Emitting Diode (LED)		6SCD1
☐ 3	(1)	1-Snap Wire		6SC01	☐ 1	(L1)	2.5V or 3V Lamp		6SCL1
☐ 6	(2)	2-Snap Wire		6SC02	☐ 1	(B1)	Battery Holder - uses 2 1.5V type AA (not included)		6SCB1
☐ 3	(3)	3-Snap Wire		6SC03	☐ 1	(SP)	Speaker		6SCSP
☐ 1	(4)	4-Snap Wire		6SC04	☐ 1	(U1)	Music Integrated Circuit		6SCU1
☐ 1	(5)	5-Snap Wire		6SC05	☐ 1	(U2)	Alarm Integrated Circuit		6SCU2
☐ 1	(6)	6-Snap Wire		6SC06	☐ 1	(U3)	Space War Integrated Circuit		6SCU3
☐ 1	(WC)	Whistle Chip		6SCWC	☐ 1 ☐ 1	(M1)	Motor Fan		6SCM1 6SCM1F
☐ 1	(S1)	Slide Switch		6SCS1	☐ 1	(R1)	100w Resistor		6SCR1
☐ 1	(S2)	Press Switch		6SCS2	☐ 1 ☐ 1		Jumper Wire (Black) Jumper Wire (Red)	 	6SCJ1 6SCJ2
☐ 1	(RP)	Photoresistor		6SCRP	<b>You may order additional / replacement parts at our website: <a href="http://www.elenco.com/replacement-parts/">www.elenco.com/replacement-parts/</a></b>				

## How To Use It

Snap Circuits® uses building blocks with snaps to build the different electrical and electronic circuits in the projects. Each block has a function: there are switch blocks, lamp blocks, battery blocks, different length wire blocks, etc. These blocks are in different colors and have numbers on them so that you can easily identify them. The circuit you will build is shown in color and with numbers, identifying the blocks that you will use and snap together to form a circuit.

### For Example:

This is the switch block which is green and has the marking (S1) on it as shown in the drawings. Please note that the drawing doesn't reflect the real switch block exactly (it is missing the ON and OFF markings), but gives you the general idea of which part is being used in the circuit.



This is a wire block which is blue and comes in different wire lengths. This one has the number (2), (3), (4), (5), or (6) on it depending on the length of the wire connection required.

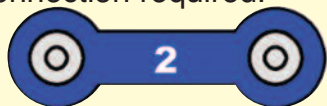

This is a 1-snap wire that is used as a spacer or for interconnection between different layers.



To build each circuit, you have a power source block number (B1) that needs two (2) "AA" batteries (not included with the Snap Circuits® kit).



Note: This set has a 2 battery holder.

When installing a battery, be sure the spring is compressed straight back, and not bent up, down, or to one side. Battery installation should be supervised by an adult.

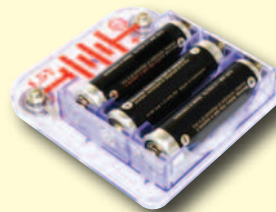

Note: This set has a 2 battery holder.

A large clear plastic base grid is included with this kit to help keep the circuit blocks properly spaced. You will see evenly spaced posts that the

different blocks snap into. You do not need this base to build your circuits, but it does help in keeping your circuit together neatly. The base has rows labeled A-G and columns labeled 1-10.

Next to each part in every circuit drawing is a small number in black. This tells you which level the component is placed at. Place all parts on level 1 first, then all of the parts on level 2, then all of the parts on level 3, etc.

Usually when the motor (M1) is used, the fan will usually be placed on it. On top of the motor shaft is a black plastic piece (the motor top) with three little tabs. Lay the fan on the black piece so the slots in its bottom "fall into place" around the three tabs in the motor top. If not placed properly, the fan will fall off when the motor starts to spin.

Some circuits use the jumper wires to make unusual connections. Just clip them to the metal snaps or as indicated.



**Note:** While building circuits, be careful not to accidentally make a direct connection across the battery holder (a "short circuit"), as this may damage and/or quickly drain the batteries.

# About Your Snap Circuits® Parts

Our Student Guides give much more information about your parts along with a complete lesson in basic electronics. See [www.elenco.com/faqs](http://www.elenco.com/faqs) or page 45 for more information.

(Part designs are subject to change without notice).

**Note:** If you have the more advanced Models SC-300, SC-500, or SC-750, there is additional information in your other project manual(s).

The **base grid** functions like the printed circuit boards found in most electronic products. It is a platform for mounting parts and wires (though the wires are usually “printed” on the board).

The blue **snap wires** are just wires used to connect other components, they are used to transport electricity and do not affect circuit performance. They come in different lengths to allow orderly arrangement of connections on the base grid.

The red and black **jumper wires** make flexible connections for times when using the snap wires would be difficult. They also are used to make connections off the base grid (like the projects using water).

The **batteries (B1)** produce an electrical voltage using a chemical reaction. This “voltage” can be thought of as electrical pressure, pushing electrical “current” through a circuit. This voltage is much lower and much safer than that used in your house wiring. Using more batteries increases the “pressure” and so more electricity flows.

The **slide switch (S1)** connects (ON) or disconnects (OFF) the wires in a circuit. When ON it has no effect on circuit performance.

The **press switch (S2)** connects (pressed) or disconnects (not pressed) the wires in a circuit, just like the slide switch does.

Resistors, such as the **100W resistor (R1)**, “resist” the flow of electricity and are used to control or limit the electricity in a circuit. Increasing circuit resistance reduces the flow of electricity.

The **photoresistor (RP)** is a light-sensitive resistor, its value changes from nearly infinite in total darkness to about 1000Ω when a bright light shines on it.

A light bulb, such as in the **2.5V lamp (L1)**, contains a special wire that glows bright when a large electric current passes through it. Voltages above the bulb’s rating can burn out the wire.

The **motor (M1)** converts electricity into mechanical motion. Electricity is closely related to magnetism, and an electric current flowing in a wire has a magnetic field similar to that of a very, very tiny magnet. Inside the motor is three coils of wire with many loops. If a large electric current flows through the loops, the magnetic effects become concentrated enough to move the coils. The motor has a magnet inside so, as the electricity moves the coils to align them with the permanent magnet, the shaft spins.

The **speaker (SP)** converts electricity into sound. It does this by using the energy of a changing electrical signal to create mechanical vibrations (using a coil and magnet similar to that in the motor), these vibrations create

variations in air pressure which travel across the room. You “hear” sound when your ears feel these air pressure variations.

The **whistle chip (WC)** contains two thin plates. When an electrical signal is applied across them they will stretch slightly in an effort to separate (like two magnets opposing each other), when the signal is removed they come back together. If the electrical signal applied across them is changing quickly, then the plates will vibrate. These vibrations create variations in air pressure that your ears feel just like sound from a speaker.

The **LED (D1)** is a light emitting diode, and may be thought of as a special one-way light bulb. In the “forward” direction (indicated by the “arrow” in the symbol) electricity flows if the voltage exceeds a turn-on threshold (about 1.5V); brightness then increases. A high current will burn out the LED, so the current must be limited by other components in the circuit. LEDs block electricity in the “reverse” direction.

Some types of electronic components can be super-miniaturized, allowing many thousands of parts to fit into an area smaller than your fingernail. These “integrated circuits” (ICs) are used in everything from simple electronic toys to the most advanced computers. The music, alarm, and space war ICs (U1, U2, and U3) in Snap Circuits® are actually modules containing specialized sound-generation ICs and other supporting components (resistors, capacitors, and transistors) that are always needed with them. This was done to simplify the connections you need to make to use them. The descriptions for these modules are given here for those interested, see the projects for connection examples:

### Music IC:

- (+) - power from batteries
- (-) - power return to batteries
- OUT - output connection
- HLD - hold control input
- TRG - trigger control input

Music for a few seconds on power-up, then hold HLD to (+) power or touch TRG to (+) power to resume music.

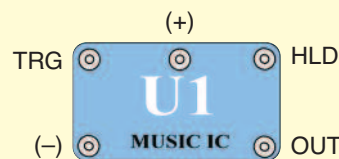

### Alarm IC:

- IN1, IN2, IN3 - control inputs
- (-) - power return to batteries
- OUT - output connection

Connect control inputs to (+) power to make five alarm sounds, see project 22 for configurations.

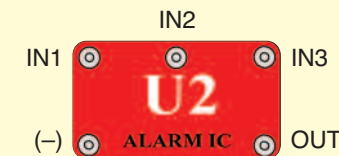

### Space War IC:

- (+) - power from batteries
- (-) - power return to batteries
- OUT - output connection
- IN1, IN2 - control inputs

Connect each control input to (-) power to sequence through 8 sounds.



# DOs and DON'Ts of Building Circuits

After building the circuits given in this booklet, you may wish to experiment on your own. Use the projects in this booklet as a guide, as many important design concepts are introduced throughout them. Every circuit will include a power source (the batteries), a resistance (which might be a resistor, lamp, motor, integrated circuit, etc.), and wiring paths between them and back. **You must be careful not to create "short circuits" (very low-resistance paths across the batteries, see examples below) as this will damage components and/or quickly drain your batteries.** Only connect the ICs using configurations given in the projects, incorrectly doing so may damage them. **Elenco® is not responsible for parts damaged due to incorrect wiring.**

## Here are some important guidelines:

- ALWAYS USE EYE PROTECTION WHEN EXPERIMENTING ON YOUR OWN.**
- ALWAYS** include at least one component that will limit the current through a circuit, such as the speaker, lamp, whistle chip, ICs (which must be connected properly), motor, photoresistor, or resistor.
- ALWAYS** use the LED and switches in conjunction with other components that will limit the current through them. Failure to do so will create a short circuit and/or damage those parts.
- ALWAYS** disconnect your batteries immediately and check your wiring if something appears to be getting hot.
- ALWAYS** check your wiring before turning on a circuit.
- ALWAYS** connect ICs using configurations given in the projects or as per the connection descriptions for the parts.
- NEVER** connect to an electrical outlet in your home in any way.
- NEVER** leave a circuit unattended when it is turned on.
- NEVER** touch the motor when it is spinning at high speed.

**Note:** If you have the more advanced Models SC-300, SC-500, or SC-750, there are additional guidelines in your other project manual(s).

For all of the projects given in this book, the parts may be arranged in different ways without changing the circuit. For example, the order of parts connected in series or in parallel does not matter — what matters is how combinations of these sub-circuits are arranged together.

**Warning to Snap Circuits® owners:** Do not connect additional voltage sources from other sets, or you may damage your parts. Contact ELENCO® if you have questions or need guidance.

## Examples of SHORT CIRCUITS - NEVER DO THESE!!!

Placing a 3-snap wire directly across the batteries is a **SHORT CIRCUIT**.

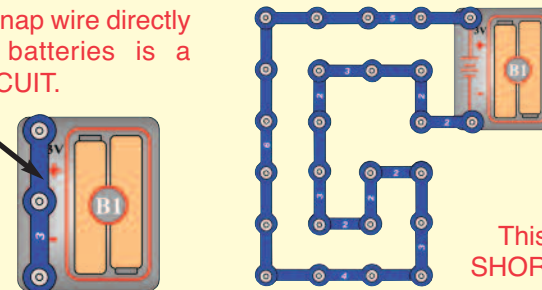

This is also a **SHORT CIRCUIT**.

When the slide switch (S1) is turned on, this large circuit has a **SHORT CIRCUIT** path (as shown by the arrows). The short circuit prevents any other portions of the circuit from ever working.

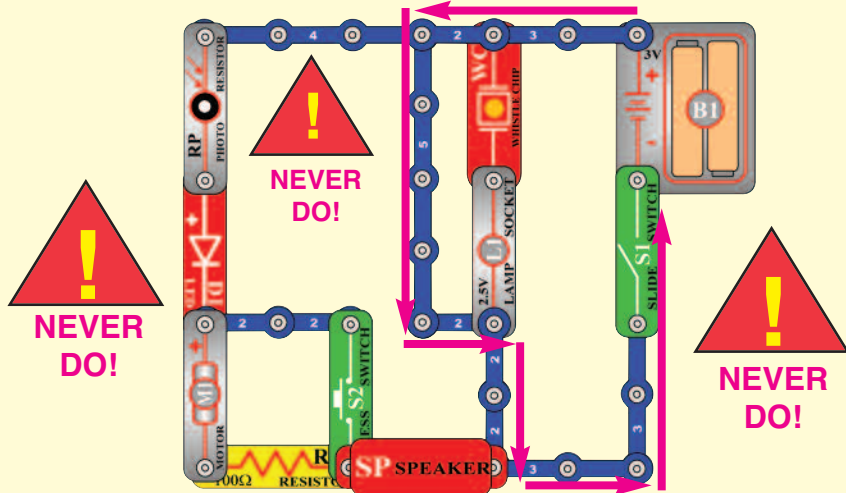

You are encouraged to tell us about new circuits you create. If they are unique, we will post them with your name and state on our website at [www.elenco.com/for-makers](http://www.elenco.com/for-makers). Send your suggestions to [Elenco@elenco.com](mailto:Elenco@elenco.com).

Elenco® provides a circuit designer so that you can make your own Snap Circuits® drawings. This Microsoft® Word document can be downloaded from [www.elenco.com/for-makers](http://www.elenco.com/for-makers).

**WARNING: SHOCK HAZARD** - Never connect Snap Circuits® to the electrical outlets in your home in any way!



## Advanced Troubleshooting (Adult supervision recommended)

Elenco® is not responsible for parts damaged due to incorrect wiring.

If you suspect you have damaged parts, you can follow this procedure to systematically determine which ones need replacing:

1. **2.5V lamp (L1), motor (M1), speaker (SP), and battery holder (B1):** Place batteries in holder. Place the 2.5V lamp directly across the battery holder, it should light. Do the same with the motor (motor + to battery +), it should spin to the right at high speed. "Tap" the speaker across the battery holder contacts, you should hear static as it touches. If none work, then replace your batteries and repeat, if still bad then the battery holder is damaged.

2. **Jumper wires:** Use this mini-circuit to test each jumper wire, the lamp should light.

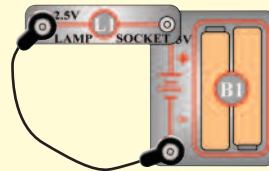

3. **Snap wires:** Use this mini-circuit to test each of the snap wires, one at a time. The lamp should light.

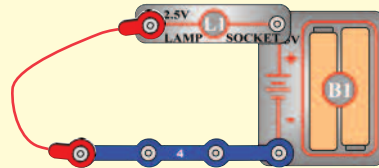

4. **Slide switch (S1) and Press switch (S2):** Build project #1, if the lamp (L1) doesn't light then the slide switch is bad. Replace the slide switch with the press switch to test it.

5. **100W resistor (R1) and LED (D1):** Build project #7 except initially use the speaker (SP) in place of the resistor, the LED should light. Then replace the speaker with the resistor; the LED should still light.

6. **Alarm IC (U2):** Build project #17, you should hear a siren. Then place a 3-snap wire between grid locations A1 and C1, the sound is different. Then move the 3-snap from A1-C1 to A3-C3 to hear a 3rd sound.

7. **Music IC (U1):** Build project #74 but use the press switch (S2) in place of the photoresistor (RP). Turn it on and the LED (D1) flickers for a while and stops, it resumes if you press and hold down the press switch. Then touch a 3-snap wire across base grid points A1 and C1 and the flickering resumes for a while.

8. **Space war IC (U3) and photoresistor (RP):** Build project #19, both switches (S1 and S2) should change the sound. Then replace the slide switch with the photoresistor, waving your hand over it should change the sound.

9. **Whistle chip (WC):** Build project #61 and if there is light on the photoresistor (RP) then you will hear sound from the whistle chip.

Note: If you have the more advanced models SC-300, SC-500, or SC-750, there are additional tests in your other project manual(s).

**ELENCO®**

150 Carpenter Avenue  
Wheeling, IL 60090 U.S.A.  
Phone: (847) 541-3800  
Fax: (847) 520-0085  
e-mail: [help@elenco.com](mailto:help@elenco.com)  
Website: [www.elenco.com](http://www.elenco.com)

You may order additional / replacement parts at:  
[www.elenco.com/replacement-parts/](http://www.elenco.com/replacement-parts/)

# Project Listings

Project #	Description	Page #	Project #	Description	Page #	Project #	Description	Page #
1	Electric Light & Switch	8	35	Motor Space Light	20	69	Space War Siren	34
2	DC Motor & Switch	8	36	Space Battle (II)	21	70	Quiet Water Alarm	34
3	Sound Activated Switch	9	37	Silent Space Battle	21	71	Light-Controlled Lamp	35
4	Adjusting Sound Level	9	38	Periodic Sounds	21	72	Voice-Controlled Lamp	35
5	Lamp & Fan in Series	10	39	Blinking Double Flashlight	21	73	Motor-Controlled Lamp	35
6	Lamp & Fan in Parallel	10	40	Motor-Controlled Sounds	22	74	Light-Controlled LED	36
7	Light Emitting Diode	11	41	More Motor Sounds	22	75	Sound-Controlled Time Delay LED	36
8	One Direction for LED	11	42	More Motor Sounds (II)	22	76	Motor-Controlled Time Delay LED	36
9	Conduction Detector	12	43	More Motor Sounds (III)	22	77	Space War Flicker LED	37
10	Space War Alarm Combo	12	44	More Motor Sounds (IV)	22	78	Music AND Gate	37
11	Flying Saucer	13	45	Light-Controlled Flicker	23	79	Flash and Tone	37
12	Decreasing Saucer Lift	13	46	More Sound Effects	23	80	Lamp, Speaker & Fan in Parallel	38
13	Two-Speed Fan	14	47	This OR That	24	81	Pencil Alarm	38
14	The Fuse	14	48	This AND That	24	82	Pencil Alarm Variants	38
15	Musical Doorbell	15	49	Neither This NOR That	25	83	Fun with the Alarm IC	39
16	Momentary Alarm	15	50	NOT This AND That	25	84	Motor Sounds Combo	39
17	Alarm Circuit	16	51	Reflection Detector	26	85	Motor Sounds Combo (II)	39
18	Laser Gun	16	52	Quieter Reflection Detector	26	86	Music Alarm Combo	40
19	Space War	17	53	Flashing Laser Light with Sound	27	87	Bomb Sound	40
20	Light Switch	17	54	Space War Flicker	27	88	Bomb Sound (II)	40
21	Paper Space War	17	55	Spinning Rings	28	89	Light-Controlled LED (II)	41
22	Light Police Siren	18	56	Strobe the House Lights	28	90	Touch Light	41
23	More Loud Sounds	18	57	Race Game	29	91	Touch Sound	41
24	More Loud Sounds (II)	18	58	Using Parts as Conductors	29	92	Wacky Sounds	41
25	More Loud Sounds (III)	18	59	Spin Draw	30	93	Wackier Sounds	42
26	More Loud Sounds (IV)	18	60	Space War Flicker Motor	30	94	Really Wacky Sounds	42
27	Clap Sounds	19	61	Light-Controlled Sounds	31	95	Noisier Water Space War	43
28	More Clap Sounds	19	62	Light-Controlled Sounds (II)	31	96	Light/Water Space War	43
29	More Clap Sounds (II)	19	63	Light-Controlled Sounds (III)	31	97	OR/AND Space War Light	43
30	More Clap Sounds (III)	19	64	Light-Controlled Sounds (IV)	31	98	Simple Water Alarm	44
31	More Clap Sounds (IV)	19	65	Light-Controlled Sounds (V)	31	99	Simple Salt Water Alarm	44
32	Voice Light Diode	20	66	Electronic Bombing Game	32	100	Ambulance Water Alarm	44
33	Voice Control	20	67	Quiet Zone Game	33	101	Ambulance Contact Alarm	44
34	Motor Space Sounds	20	68	Space War Music Combo	33			





# Project #1

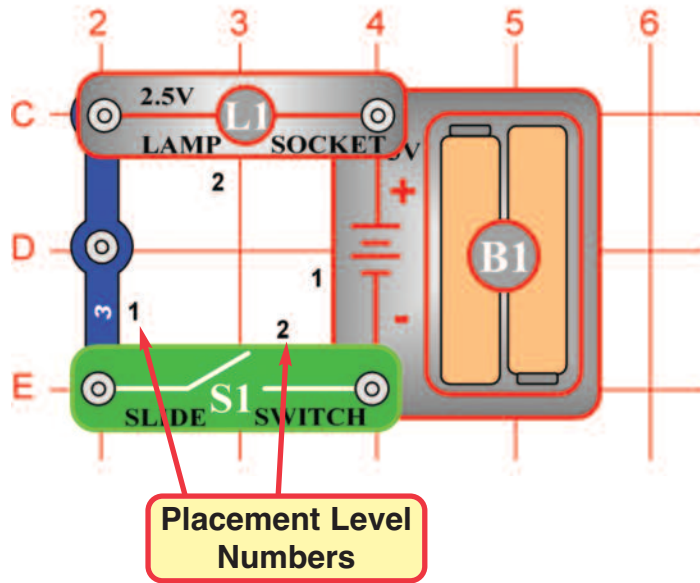

# Electric Light & Switch

**OBJECTIVE:** To show how electricity is turned “ON” or “OFF” with a switch.

Build the circuit shown on the left by placing all the parts with a black 1 next to them on the base grid first. Then, assemble parts marked with a 2. Install two (2) “AA” batteries (not included) into the battery holder (B1). When installing a battery, be sure the spring is compressed straight back, and not bent up, down, or to one side. Battery installation should be supervised by an adult.

When you close the slide switch (S1), current flows from the batteries through the lamp and back to the battery through the switch. The closed switch completes the circuit. In electronics this is called a closed circuit. When the slide switch is opened, the current can no longer flow back to the battery, so the lamp goes out. In electronics this is called an open circuit.

You may have received a 3V lamp instead of a 2.5V lamp or socket, this will not affect any of your circuits.



# Project #2

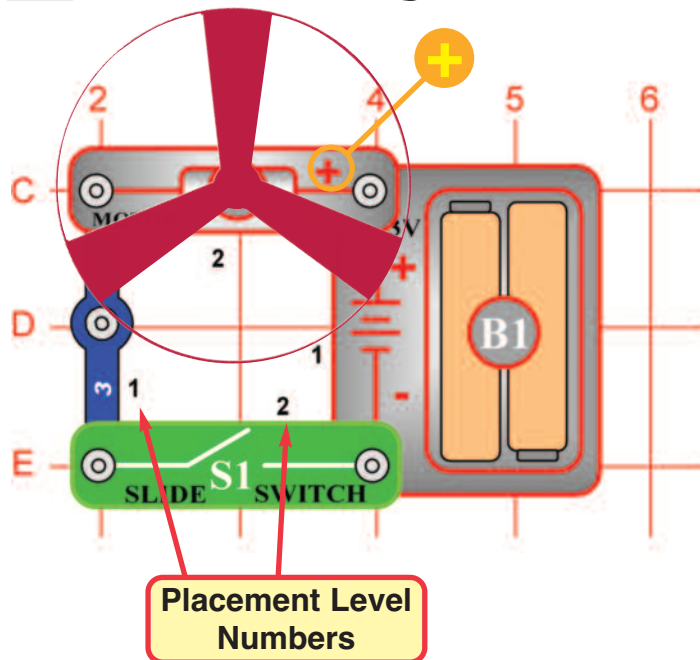

# DC Motor & Switch

**OBJECTIVE:** To show how electricity is used to run a Direct Current (DC) Motor.

Build the circuit shown on the left by placing all the parts with a black 1 next to them on the base grid first. Then, assemble parts marked with a 2.

When you close the slide switch (S1), current flows from the batteries (B1) through the motor (M1) making it rotate. Place the fan blade on the motor shaft and close the slide switch. The motor will rotate forcing the fan blade to move air past the motor.

In this project, you changed electrical power into mechanical power. DC motors are used in all the battery powered equipment requiring rotary motion, such as a cordless drill, electric toothbrush, and toy trains that run on batteries just to name a few. An electric motor is much easier to control than gas or diesel engines.



**WARNING:** Moving parts. Do not touch the fan or motor during operation. Do not lean over the motor.



## Project #3

## Sound Activated Switch

**OBJECTIVE:** To show how sound can turn “ON” an electronic device.

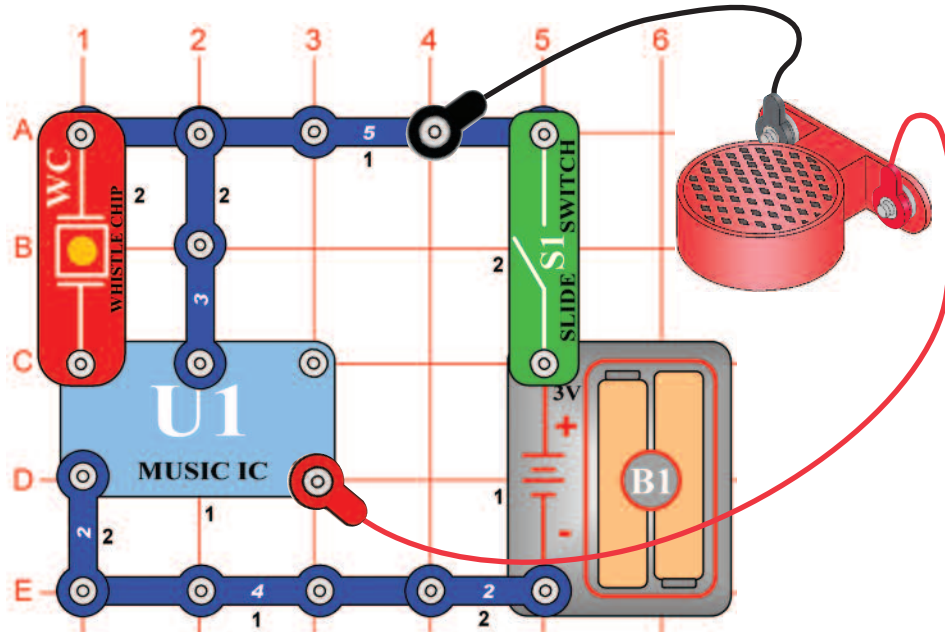

Build the circuit shown on the left by placing all the parts with a black 1 next to them on the base grid first. Then, assemble parts marked with a 2. Finally, lay the speaker (SP) on the table and connect it to the circuit using the jumper wires as shown.

When you close the slide switch (S1), the music may play for a short time, and then stop. After the music has stopped, blow or tap on the whistle chip (WC) and the music should play again.

You could connect the speaker using snap wires instead of the jumper wires, but then the speaker may create enough sound vibrations to re-activate the whistle chip.



## Project #4

## Adjusting Sound Level

**OBJECTIVE:** To show how resistance can lower the sound from the speaker.

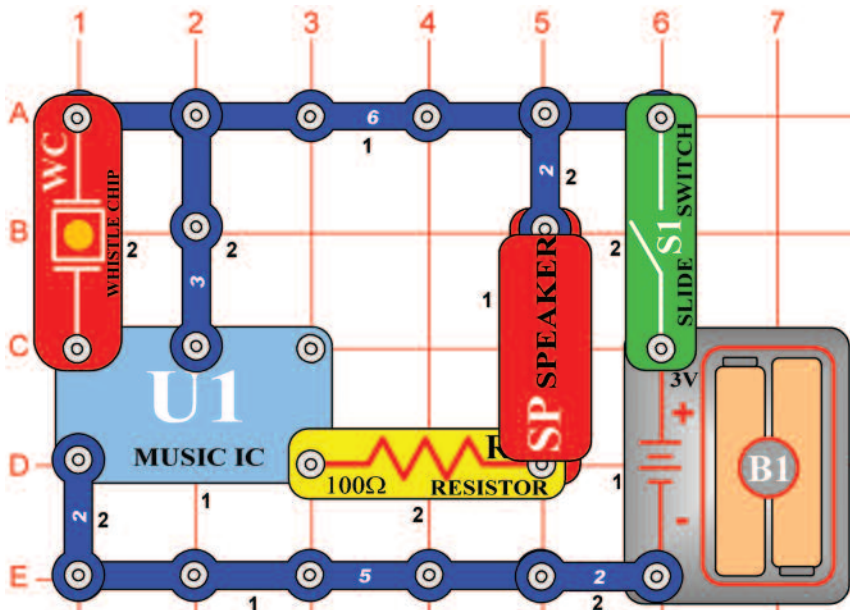

Build the circuit shown on the left. When you close the slide switch (S1), the music may play for a short time and then stop. After the music has stopped, clap your hands close to the whistle chip (WC) or tap the base with your finger. The music should play again for a short time, then stop.

In this project, you changed the amount of current that goes through the speaker (SP) and reduced the sound output of the speaker. Resistors are used throughout electronics to limit the amount of current that flows.



## Project #5

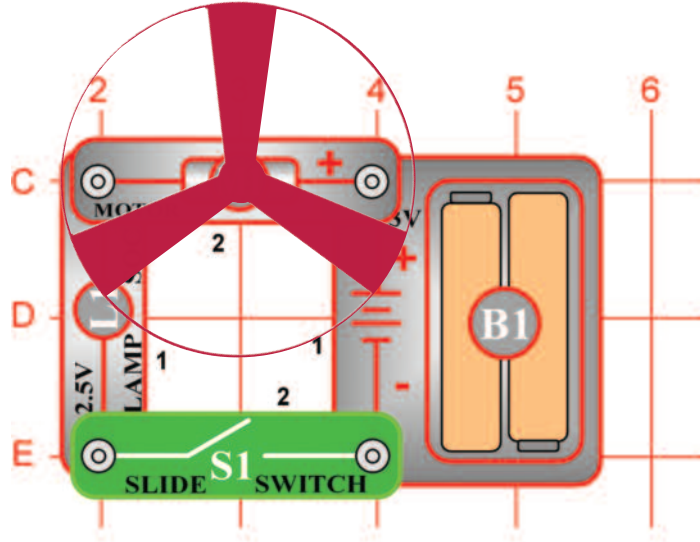

## Lamp & Fan in Series

**OBJECTIVE:** To show how a lamp can indicate when a fan is running.

Build the circuit shown on the left by placing all the parts with a black 1 next to them on the base grid first. Then, assemble parts marked with a 2. Finally, place the fan blade on the motor (M1).

When you close the slide switch (S1), the fan will spin and the lamp (L1) should turn on. The fan will take a while to start turning due to inertia. Inertia is the property that tries to keep a body at rest from moving and tries to keep a moving object from stopping.

The light helps protect the motor from getting the full voltage when the slide switch is closed. Part of the voltage goes across the lamp and the rest goes across the motor. Remove the fan and notice how the lamp gets dimmer when the motor does not have to spin the fan blade.



**WARNING:** Moving parts. Do not touch the fan or motor during operation. Do not lean over the motor.



## Project #6

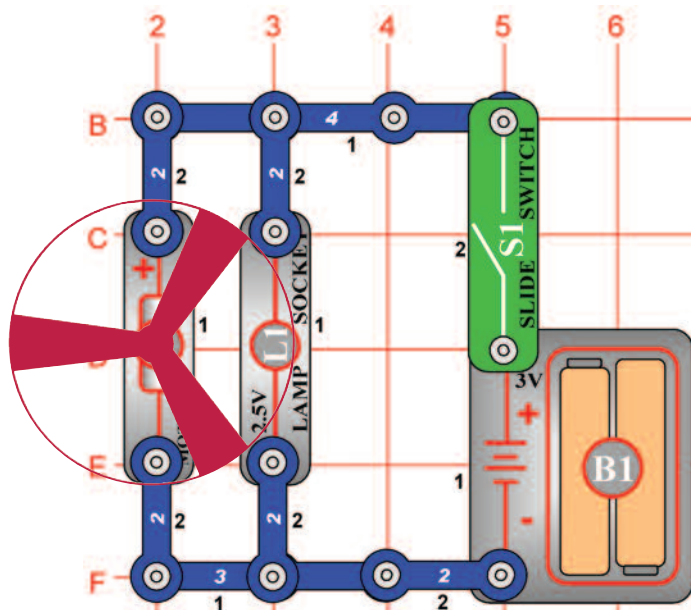

## Lamp & Fan in Parallel

**OBJECTIVE:** To show how an indicator light can be connected without affecting the current in the motor.

Build the circuit shown on the left.

When you close the slide switch (S1), both the fan and the lamp (L1) should turn on. The fan will take a while to start turning due to inertia. In this connection, the lamp does not change the current to the motor (M1). The motor should start a little faster than in Project #5.

Remove the fan and notice how the lamp does not change in brightness as the motor picks up speed. It has its own path to the battery (B1).



**WARNING:** Moving parts. Do not touch the fan or motor during operation. Do not lean over the motor.





## Project #7

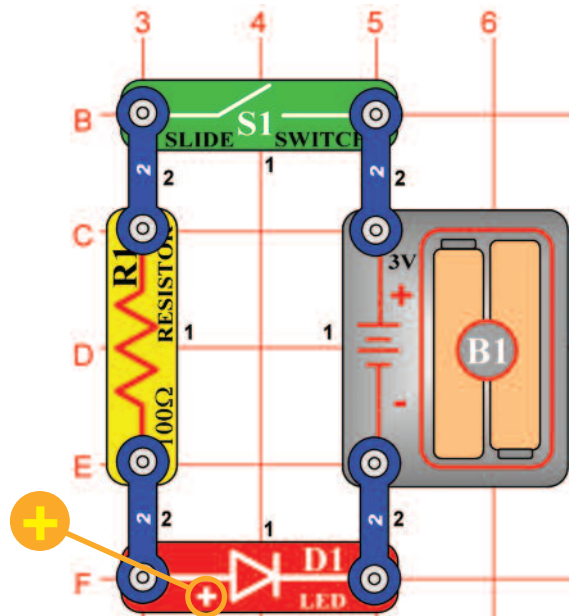

## Light Emitting Diode

**OBJECTIVE:** To show how a resistor and LED are wired to emit light.

Build the circuit shown on the left by placing all the parts with a black 1 next to them on the base grid first. Then, assemble parts marked with a 2.

When you close the slide switch (S1), current flows from the batteries (B1) through the slide switch, through the resistor (R1), through the LED (light emitting diode, D1) and back to the battery. The closed slide switch completes the circuit. The resistor limits the current and prevents damage to the LED. NEVER PLACE AN LED DIRECTLY ACROSS THE BATTERY! If no resistor is in the circuit, the battery may push enough current through the LED to damage the semiconductor that is used to produce the light. LEDs are used in all types of electronic equipment to indicate conditions and pass information to the user of that equipment.

Can you think of something you use everyday that has an LED in it?



## Project #8

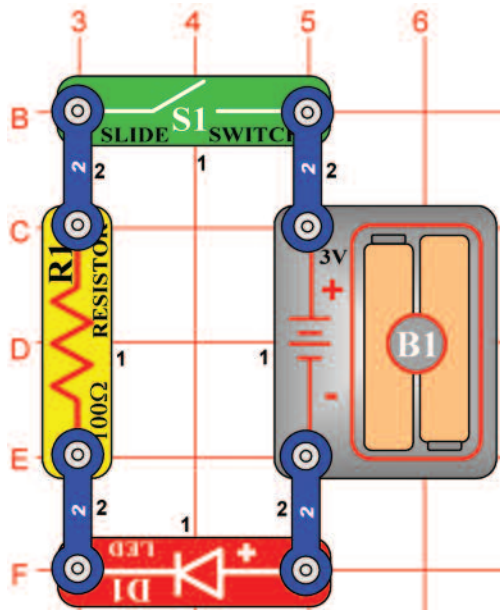

## One Direction for LED

**OBJECTIVE:** To show how electricity can only pass in one direction through an LED.

Rebuild the circuit used in Project #7 but put the LED (D1) in as shown on the left.

When you close the slide switch (S1), current should flow from the batteries (B1) through the resistor and then through the LED. When current flows through an LED, it lights up. Since the LED is in backwards, current cannot flow. The LED is like a check valve that lets current flow in only one direction.

In this project, you changed the direction of current through the LED. An electronic component that needs to be connected in one direction is said to have polarity. Other parts like this will be discussed in future projects. Placing the LED in backwards does not harm it because the voltage is not large enough to break down this electronic component.



## Project #9

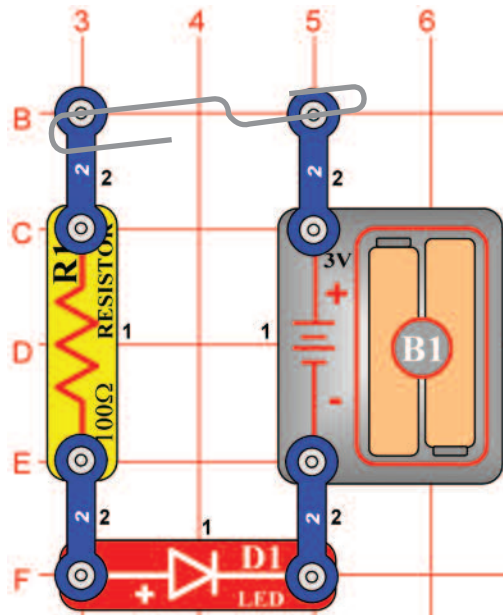

## Conduction Detector

**OBJECTIVE:** To make a circuit that detects the conduction of electricity in different materials.

Rebuild the circuit from Project #7 but leave the slide switch (S1) out as shown on the left.

When you place a metal paper clip across the terminals as shown in the picture on the left, current flows from the batteries (B1) through the resistor (R1), through the LED (D1), and back to the battery. The paper clip completes the circuit and current flows through the LED. Place your fingers across the terminals and the LED does not light. Your body has too high of a resistance to allow enough current to flow to light the LED. If the voltage, which is electrical pressure, was higher, current could be pushed through your fingers and the LED would light. This detector can be used to see if a material like plastic is a good conductor or a poor conductor.



## Project #10

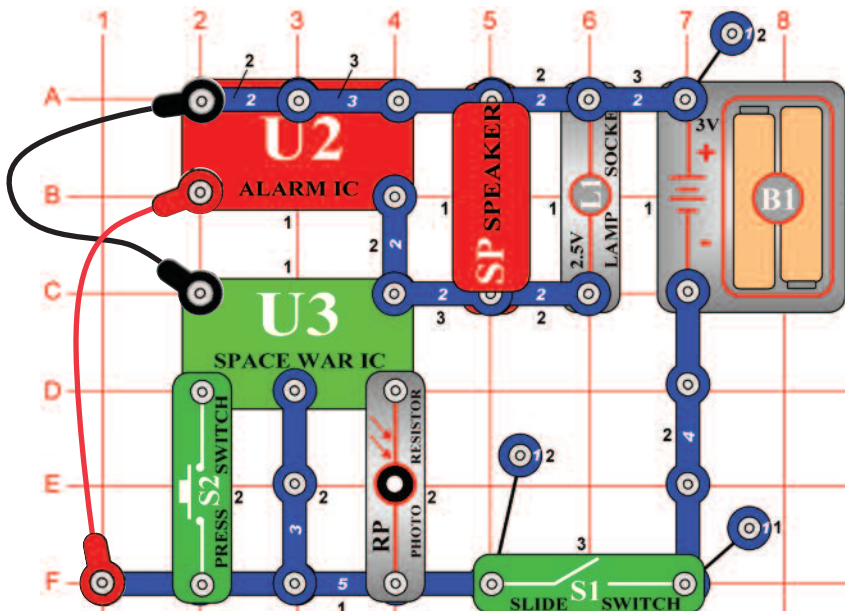

## Space War Alarm Combo

**OBJECTIVE:** To combine the sounds from the space war and alarm integrated circuits.

Build the circuit shown and add the jumpers to complete it. Turn it on, press the press switch (S2) several times, and wave your hand over the photoresistor (RP) to hear all the sound combinations. If the sound is too loud you may replace the speaker (SP) with the whistle chip (WC).



# Project #11

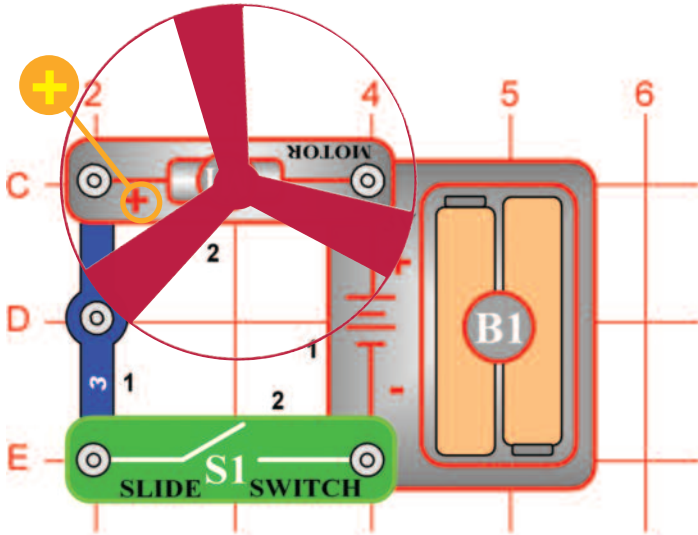

**WARNING:** Moving parts. Do not touch the fan or motor during operation. Do not lean over the motor.



**WARNING:** Fan may not rise until switch is released.

# Flying Saucer

**OBJECTIVE:** To make a circuit that launches the fan blade to simulate a flying saucer.

Rebuild the circuit from Project #2, but reverse the polarity on the motor (M1) so the negative (-) on the motor goes to the positive (+) on the battery (B1). New alkaline batteries are recommended for this project.

When you close the slide switch (S1), the motor will slowly increase in speed. When the motor has reached maximum rotation, turn the slide switch off. The fan blade should rise and float through the air like a flying saucer. Be careful not to look directly down on fan blade when it is spinning.

The air is being blown down through the blade and the motor rotation locks the fan on the shaft. When the motor is turned off, the blade unlocks from the shaft and is free to act as a propeller and fly through the air. If speed of rotation is too slow, the fan will remain on motor shaft because it does not have enough lift to propel it. The motor will spin faster when both batteries are new.

If the fan doesn't fly off, then turn the switch on and off several times rapidly when it is at full speed.



# Project #12

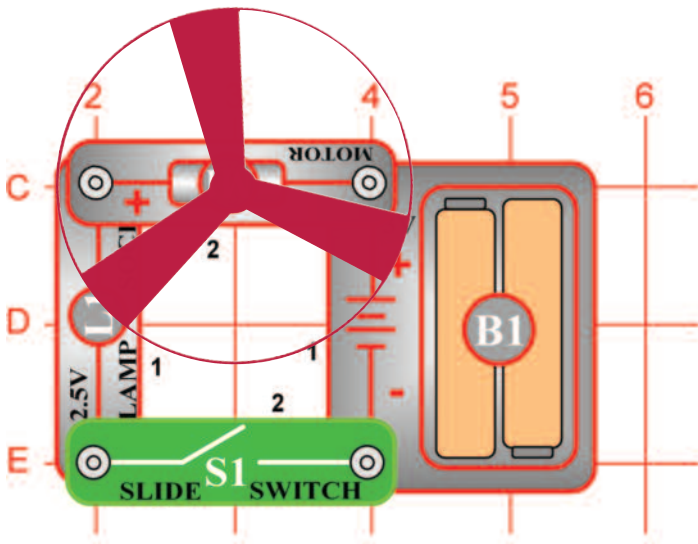

# Decreasing Saucer Lift

**OBJECTIVE:** To show how voltage affects speed of a DC motor and can decrease the lift of the saucer.

Change the circuit in Project #11 by adding the lamp (L1) in series with the motor as shown in the diagram on the left.

When you place the lamp in series with any electronic device, it will draw less current because it adds resistance. In this case, the lamp in series reduces the current through the motor, and that reduces the top speed of the motor. Close the slide switch (S1), and wait until the fan reaches maximum speed. Open the switch and observe the difference in the height due to the lamp. In most cases, it may not even launch.



**WARNING:** Moving parts. Do not touch the fan or motor during operation. Do not lean over the motor.



**WARNING:** Fan may not rise until switch is released.





# Project #13

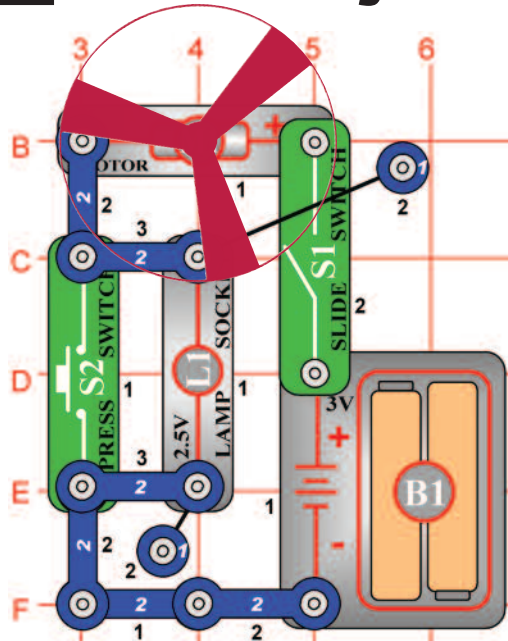

**WARNING:** Moving parts. Do not touch the fan or motor during operation. Do not lean over the motor.

# Two-Speed Fan

**OBJECTIVE:** To show how switches can increase or decrease the speed of an electric fan.

Build the circuit shown on the left by placing all the parts with a black 1 next to them on the board first. Then, assemble parts marked with a 2. Finally, add the 2-snap wires that are marked for level three.

When you close the slide switch (S1), current flows from the batteries through the slide switch (S1), motor (M1), the lamp (L1), and back to the battery (B1). When the press switch (S2) is closed, the lamp is shorted and motor speed increases.

The principle of removing resistance to increase motor speeds is only one way of changing the speed of the motor. Commercial fans do not use this method because it would produce heat in the resistor and fans are used to cool circuits by moving air over them. Commercial fans change the amount of voltage that is applied to the motor using a transformer or other electronic device.



# Project #14

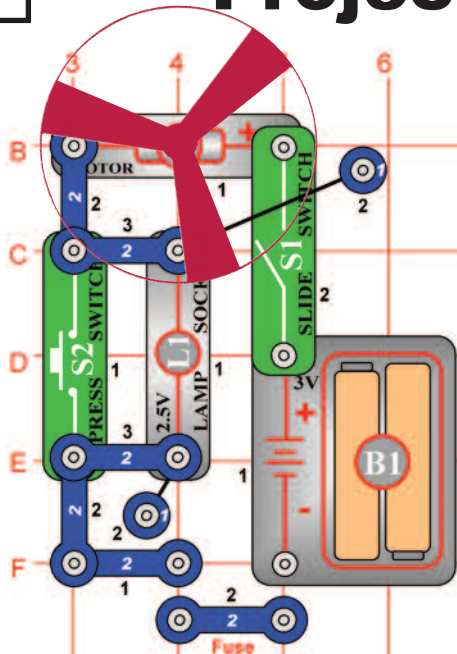

**WARNING:** Moving parts. Do not touch the fan or motor during operation. Do not lean over the motor.

# The Fuse

**OBJECTIVE:** To show how a fuse is used to break all current paths back to the voltage source.

Use the circuit built in Project #13.

When you close the slide switch (S1), current flows from the batteries through the slide switch (S1), the lamp (L1), motor (M1), and back to the battery (B1). Pretend the 2-snap wire marked fuse in the drawing on the left is a device that will open the circuit if too much current is taken from the battery. When press switch (S2) is closed, the light is shorted and motor speed increases due to an increase in current to the motor. While still holding press switch (S2) down, remove the 2-snap wire marked fuse and notice how everything stops. Until the fuse is replaced, the open circuit path protects the electronic parts. If fuses did not exist, many parts could get hot and even start fires. Replace the 2-snap wire and the circuit should return to normal.

Many electronic products in your home have a fuse that will open when too much current is drawn. Can you name some?



# Project #15

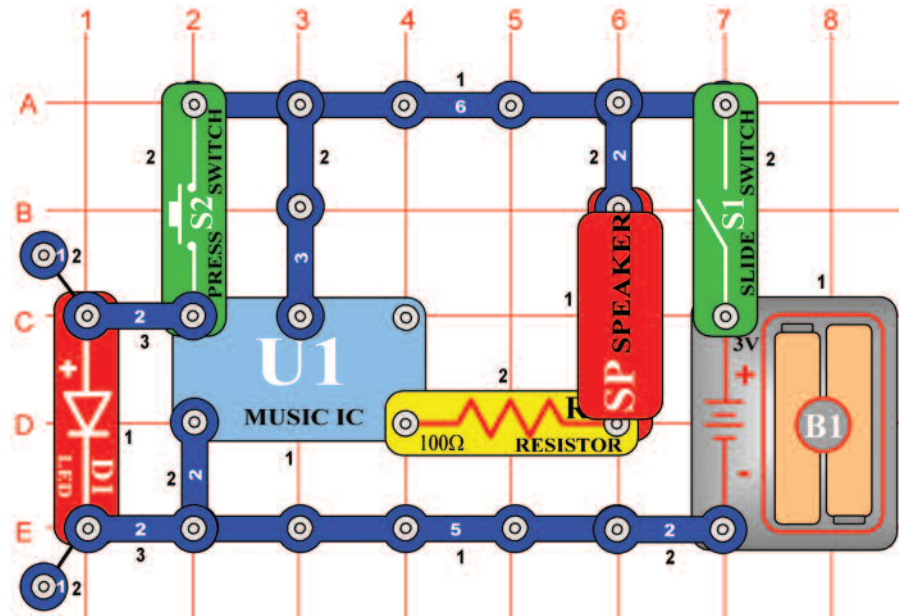

# Musical Doorbell

**OBJECTIVE:** To show how an integrated circuit can be used as a musical doorbell.

Build the circuit shown on the left. When you close the slide switch (S1), the music integrated circuit (U1) may start playing one song then stop. Each time you press the press switch “doorbell button” (S2) the song will play again and stop. Even if you let go of the press switch (S2), the integrated circuit keeps the song playing until it has reached the end of the song.

Musical integrated circuits are used to entertain young children in many of the toys and chairs made to hold infants. If the music is replaced with words, the child can also learn while they are entertained. Because of great advances in miniaturization, many songs are stored in a circuit no bigger than a pinhead.



# Project #16

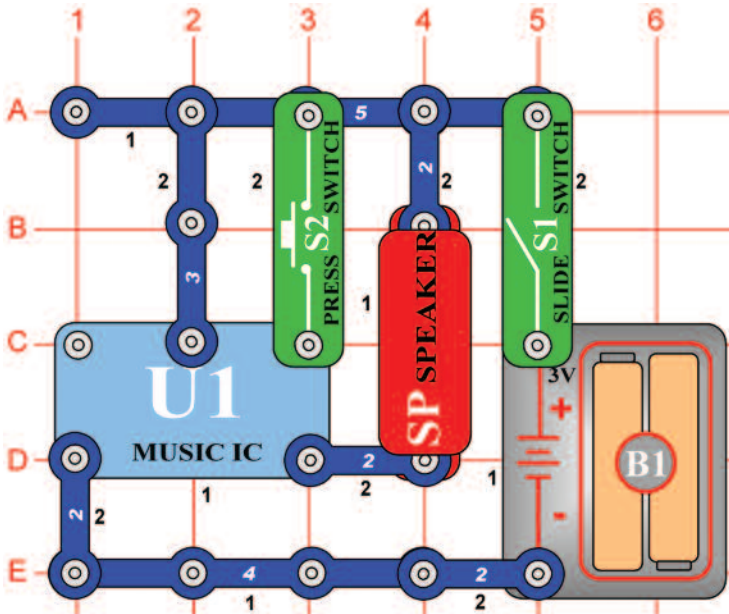

# Momentary Alarm

**OBJECTIVE:** To show how integrated circuits can also create loud alarm sounds in case of emergencies.

Modify the circuit used in Project #15 to look like the one shown on the left.

When you close the slide switch (S1), the music integrated circuit (U1) may start playing one song then stop. The song will be much louder than in the previous project because it is now being used as an alarm. Each time you press the press switch “alarm button” (S2) after the song stops playing, the song will play again, but only while you hold the button down.



# Project #17

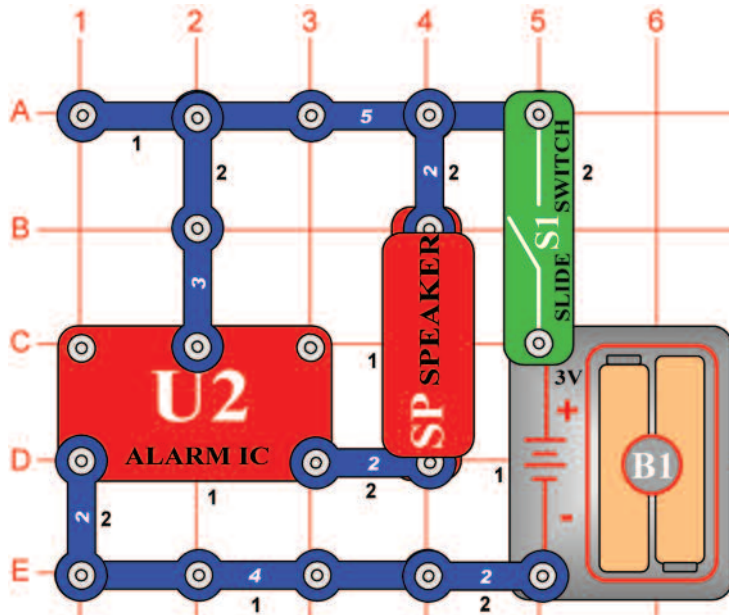

# Alarm Circuit

**OBJECTIVE:** To show how an integrated circuit can be used to make real alarm sounds.

Build the circuit shown on the left by placing all the parts with a black 1 next to them on the board first. Then, assemble parts marked with a 2. When you close the slide switch (S1), the integrated circuit (U2) should start sounding a very loud alarm sound. This integrated circuit is designed to sweep through all the frequencies so even hard of hearing people can be warned by the alarm. If the alarm sound was passed through an amplifier and installed into a police car, it would also serve as a good police siren.



# Project #18

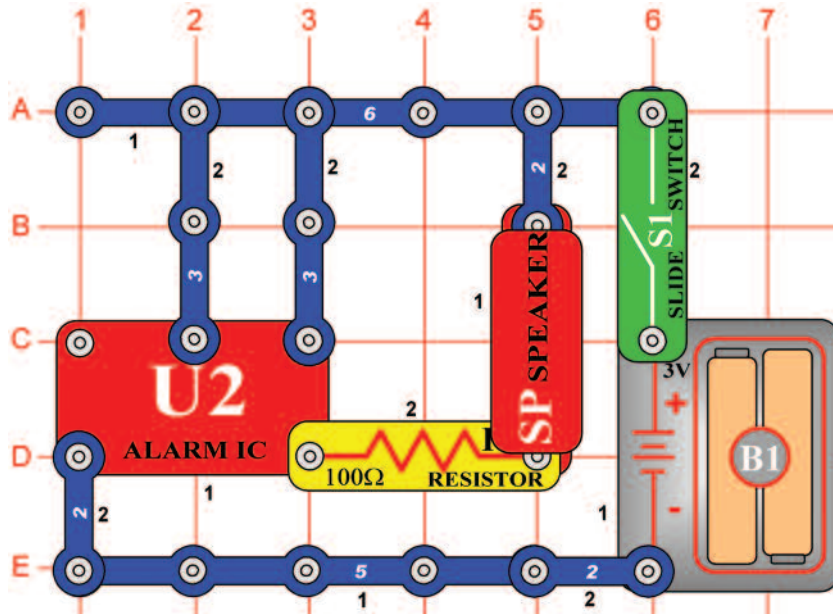

# Laser Gun

**OBJECTIVE:** To show how integrated circuits sound can easily be changed to exciting space war sounds.

Build the circuit shown on the left by placing all the parts with a black 1 next to them on the base grid first. Then, assemble parts marked with a 2. When you close the slide switch (S1), the integrated circuit (U2) should start sounding a laser gun sound. This integrated circuit is designed to produce different sounds that can easily be changed. You can even switch the sound on and off quickly to add sound effects to your games or recordings.





# Project #19

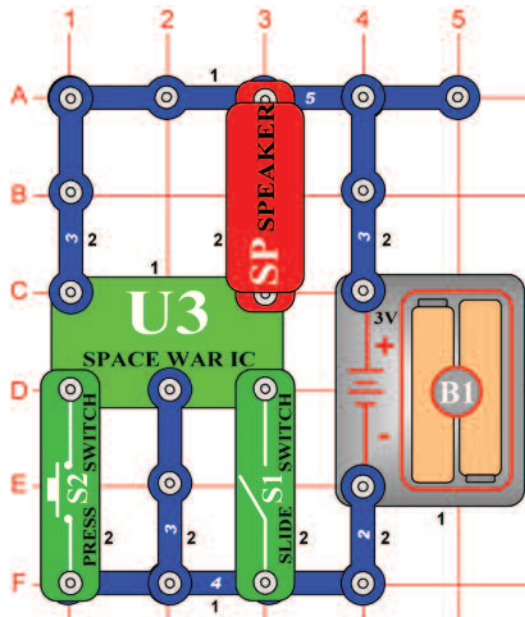

# Space War

**OBJECTIVE:** To introduce you to the space war integrated circuit and the sounds it can make.

Build the circuit shown on the left, which uses the space war integrated circuit (U3). Activate it by flipping the slide switch (S1) or pressing the press switch (S2); do both several times and in combination. You will hear an exciting range of sounds, as if a space war is raging!

Like the other integrated circuits, the space war IC is a super-miniaturized electronic circuit that can play a variety of cool sounds stored in it by using just a few extra components.

In movie studios, technicians are paid to insert these sounds at the precise instant a gun is fired. Try making your sound occur at the same time an object hits the floor. It is not as easy as it sounds.

# Project #20 Light Switch

**OBJECTIVE:** To show how light can control a circuit using a photoresistor.



Use the circuit from Project #19 above, but replace the slide switch (S1) with the photoresistor (RP). The circuit immediately makes noise. Try turning it off. If you experiment, then you can see that the only ways to turn it off are to cover the photoresistor, or to turn off the lights in the room (if the room is dark). Since light is used to turn on the circuit, you might say it is a "light switch".

The photoresistor contains material that changes its resistance when it is exposed to light. As it gets more light, the resistance of the photoresistor decreases. Parts like this are used in a number of ways that affect our lives. For example, you may have streetlights in your neighborhood that turn on when it starts getting dark and turn off in the morning.

# Project #21 Paper Space War

**OBJECTIVE:** To give a more dramatic demonstration of using the photoresistor.

Use the same circuit as for Project #20. Find a piece of white paper that has a lot of large black or dark areas on it, and slowly slide it over the photosensitive resistor. You should hear the sound pattern constantly changing, as the white and dark areas of the paper control the light to the photosensitive resistance. You can also try the pattern below or something similar to it:





# Project #22

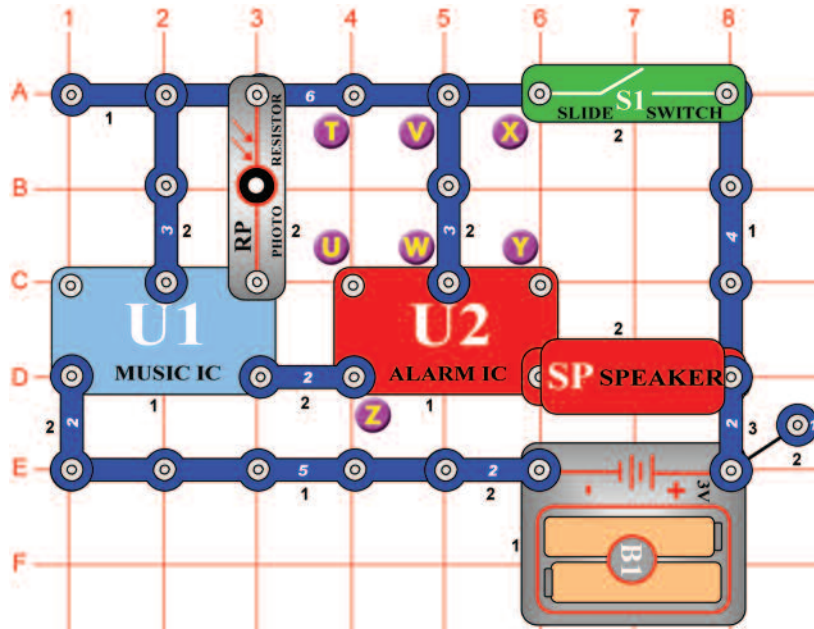

# Light Police Siren

**OBJECTIVE:** To build a police siren that is controlled by light.

Build the circuit shown on the left by placing all the parts with a black 1 next to them on the base grid first. Then, assemble parts marked with a 2. Finally, insert the parts with a 3 last on level 3.

Cover the photoresistor (RP) and turn on the slide switch (S1). A police siren with music is heard for a while and stops, then you can control it by covering or uncovering the photoresistor.

## Project #23 More Loud Sounds

**OBJECTIVE:** To show variations of the circuit in Project #22.

Modify the Project #22 by connecting points X & Y. The circuit works the same way but now it sounds like a machine gun with music.

## Project #24 More Loud Sounds (II)

**OBJECTIVE:** To show variations of the circuit in Project #22.

Now remove the connection between X & Y and then make a connection between T & U. The circuit works the same way but now it sounds like a fire engine with music.

## Project #25 More Loud Sounds (III)

**OBJECTIVE:** To show variations of the circuit in Project #22.

Now remove the connection between T & U and then make a connection between U & Z. The circuit works the same way but now it sounds like an ambulance with music.

## Project #26 More Loud Sounds (IV)

**OBJECTIVE:** To show variations of the circuit in Project #22.

Now remove the connections between U & Z and between V & W, then make a connection between T & U. The circuit works the same way but now it sounds like a familiar song but with static.



# Project #27

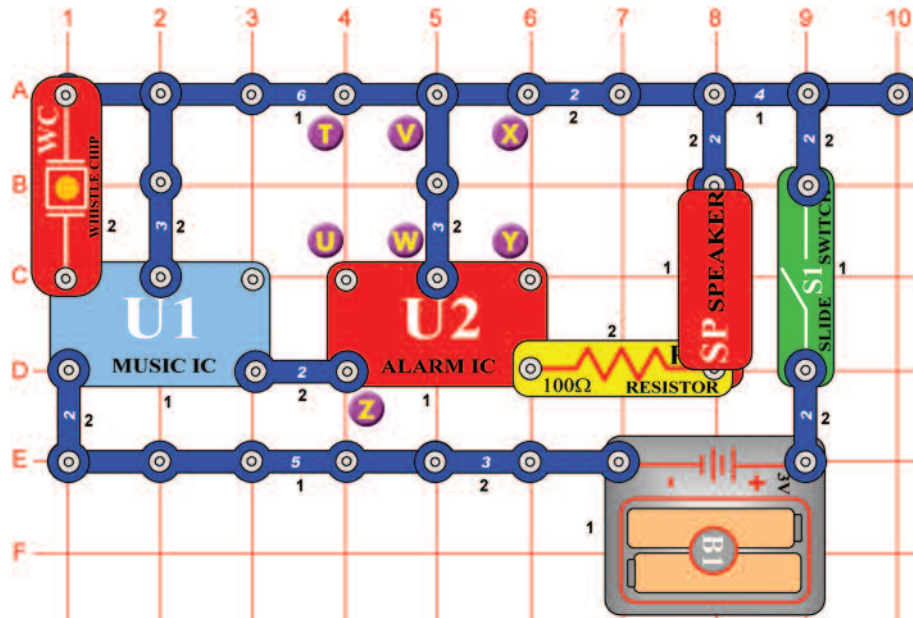

# Clap Sounds

**OBJECTIVE:** To build a police siren and other sounds that are controlled by clapping your hands.

Build the circuit shown on the left by placing all the parts with a black 1 next to them on the base grid first. Then, assemble parts marked with a 2.

Turn on the slide switch (S1) and a police siren is heard and then stops, clap your hands and it will play again. Note however that music can be heard faintly in the background of the siren. If clapping does not trigger the sound, tap the whistle chip (WC) with your finger.

## Project #28 More Clap Sounds

**OBJECTIVE:** To show how ICs can do many jobs.

Modify the last circuit by connecting points X & Y using the black jumper wire. The circuit works the same way but now it sounds like a machine gun.

## Project #29 More Clap Sounds (II)

**OBJECTIVE:** To show how ICs can do many jobs.

Now remove the connection between X & Y and then make a connection between T & U. The circuit works the same way but now it sounds like a fire engine.

## Project #30 More Clap Sounds (III)

**OBJECTIVE:** To show how ICs can do many jobs.

Now remove the connection between T & U and then make a connection between U & Z. The circuit works the same way but now it sounds like an ambulance.

## Project #31 More Clap Sounds (IV)

**OBJECTIVE:** To show how ICs can do many jobs.

Now remove the connections between U & Z and between V & W, then make a connection between T & U. The circuit works the same way but now it sounds like a familiar song but with static.



## Project #32 Voice Light Diode

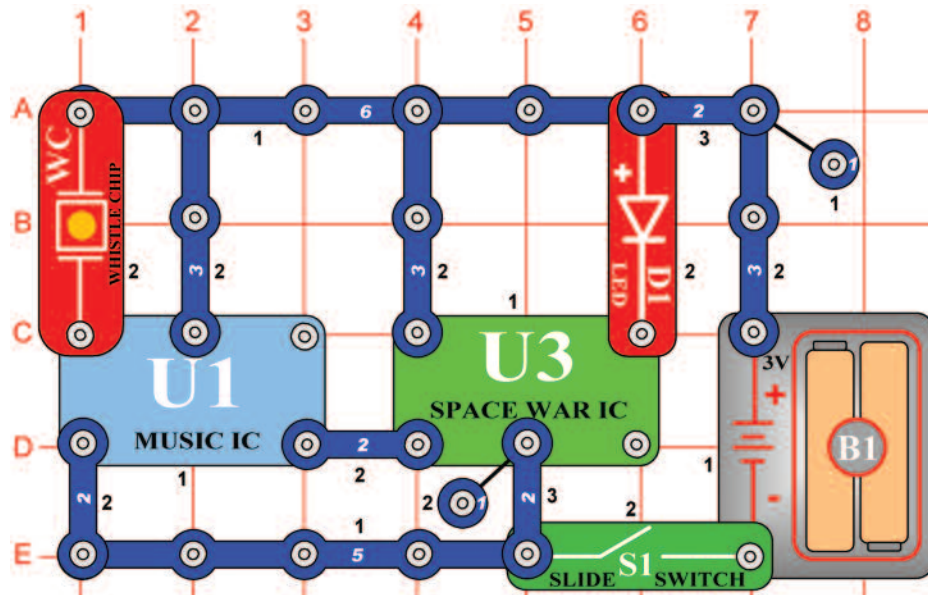

**OBJECTIVE:** To build a circuit that uses your voice to control a light emitting diode.

Build the circuit shown on the left and turn on the slide switch (S1). The LED (D1) may be on for a while and then turn off. Clap or talk loud and the LED will light again and keep flickering for a little while.

## Project #33 Voice Control

**OBJECTIVE:** To use your voice to control sounds.

The preceding circuit probably did not seem too exciting; so replace the LED (D1) with the speaker (SP). You hear a range of exciting sounds. Clap or talk loud and the sounds will resume.

If you find that the sound does not turn off, then vibrations created by the speaker may be activating the whistle chip (WC). Set the speaker on the table near the circuit and connect it to the same locations using the jumper wires to prevent this.

## Project #34 Motor Space Sounds

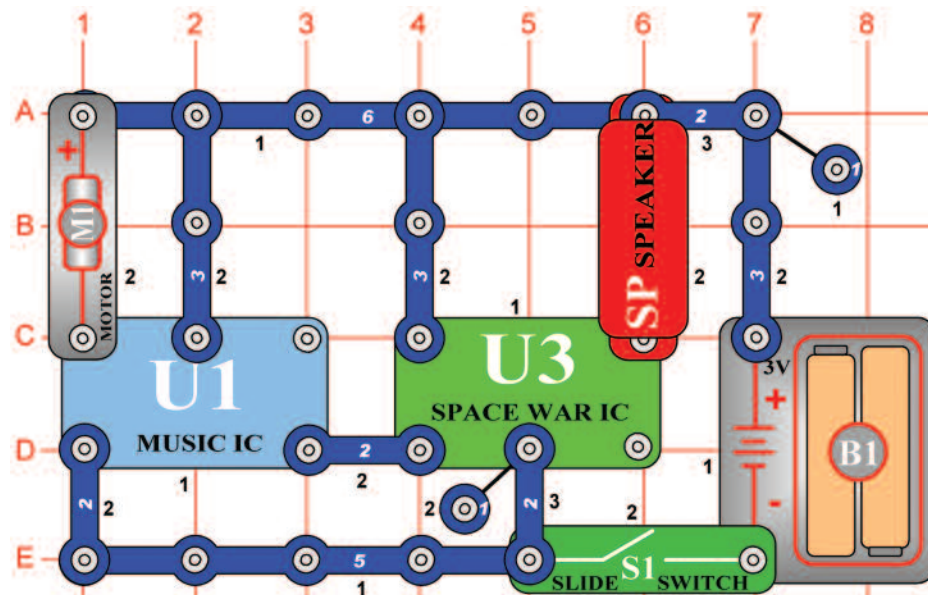

**OBJECTIVE:** To build a circuit that uses a motor to activate space war sounds.

Turn it on and wait for any sounds to stop then spin the motor (M1) and the sounds play again.

Do you know why turning the motor makes the sound play? Actually, the DC motor is also a DC generator and when you turn it, the motor generates a voltage that triggers the sound circuits.

## Project #35 Motor Space Light

**OBJECTIVE:** To build a circuit that uses a motor to activate a light diode.

This circuit is loud and may bother other people around you so replace the speaker with the LED (D1), (position it like in Project #32); the circuit operates in the same manner.

## Project #36

## Space Battle (II)

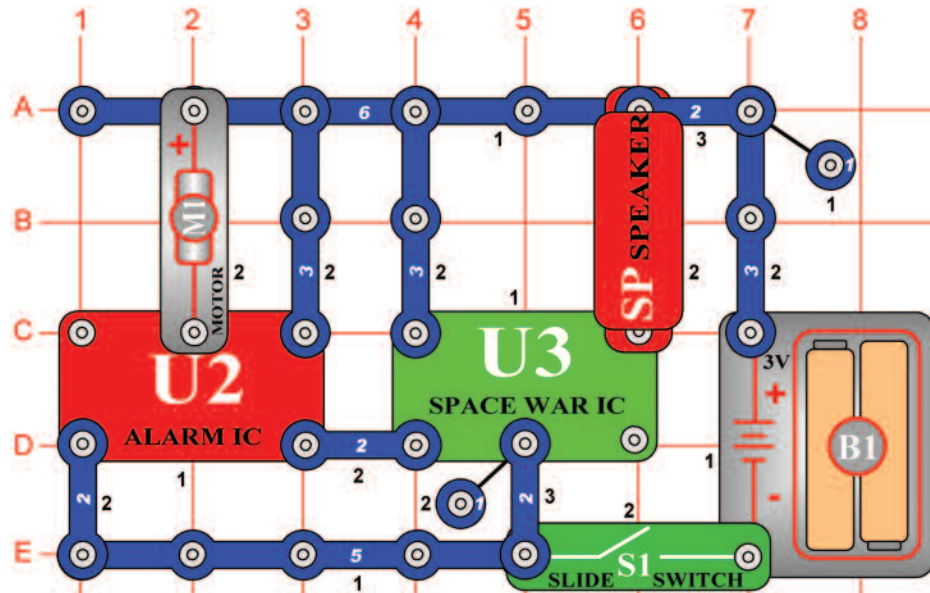

**OBJECTIVE:** To show another way of using the space war integrated circuit.

Build the circuit shown on the left, which is based on the circuit in the Space War Project #19. Turn on the switch and you will hear exciting sounds, as if a space battle is raging!

The motor is used here as a 3-snap wire, and will not spin.

## Project #37 Silent Space Battle

**OBJECTIVE:** To show another way of using the space war part.

The preceding circuit is loud and may bother people around you, so replace the speaker (SP) with the LED (D1), position it as in Project #32. Now you have a silent space battle.

## Project #38

## Periodic Sounds

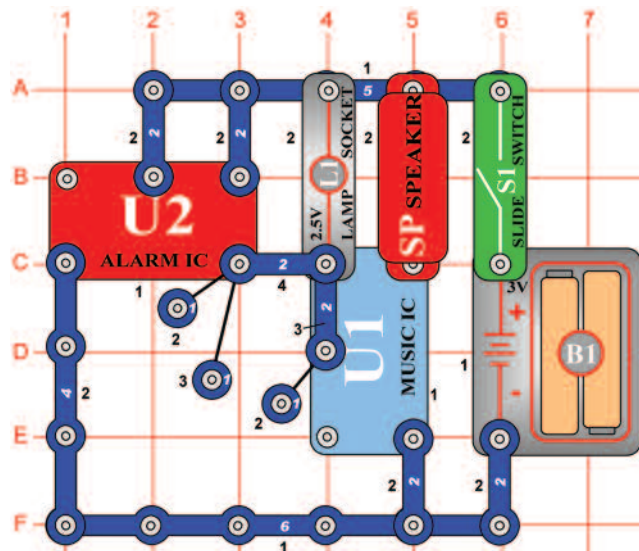

**OBJECTIVE:** To build a circuit with light and sound that change and repeat.

Build the circuit shown on the left and turn it on. The lamp (L1) alternates between being on and off while the speaker (SP) alternates between two musical tones... like someone is flipping a switch, but at a very consistent rate. Periodic signals like this are very important in electronics.

## Project #39 Blinking Double Flashlight

**OBJECTIVE:** To build a circuit with two lights that alternate.

In the circuit at left, replace the speaker (SP) with an LED (D1); position it as in Project #32. The lamp alternates between being on and off while the LED alternates between being dimmer and brighter.



# Project #40

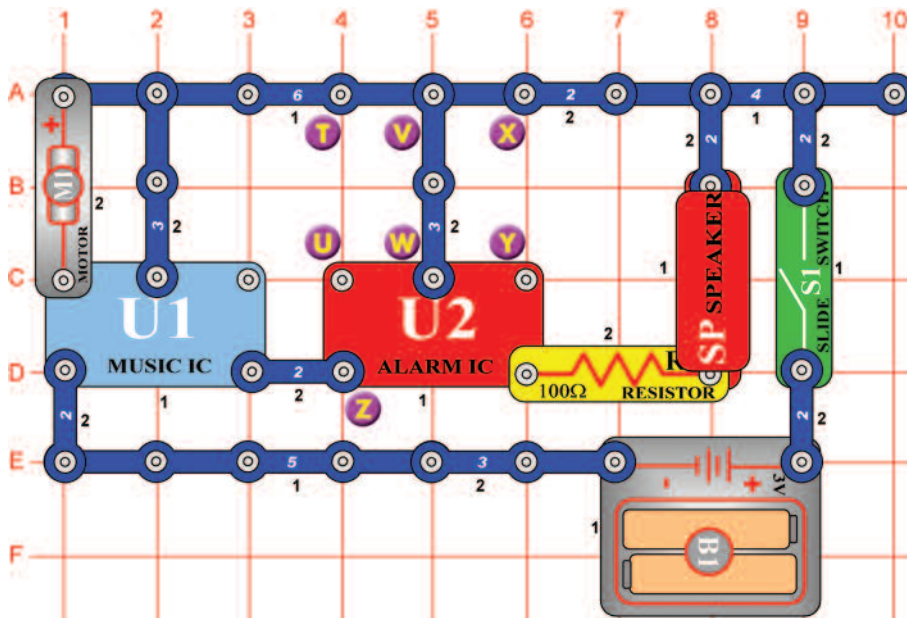

# Motor-Controlled Sounds

**OBJECTIVE:** To show how motion can trigger electronic circuits.

This circuit is controlled by spinning the motor (M1) with your hands. Turn on the slide switch (S1). A police siren is heard and then stops. Spin the motor and it will play again. Note however, that music can be heard faintly in the background of the siren.

## Project #41 More Motor Sounds

**OBJECTIVE:** To show how motion can trigger electronic circuits.

Modify the last circuit by connecting points X & Y with the lamp (L1). The circuit works the same way but now it sounds like a machine gun.

## Project #42 More Motor Sounds (II)

**OBJECTIVE:** To show how motion can trigger electronic circuits.

Now remove the connection between X & Y and then make a connection between T & U with the lamp (L1). The circuit works the same way but now it sounds like a fire engine.

## Project #43 More Motor Sounds (III)

**OBJECTIVE:** To show how motion can trigger electronic circuits.

Now remove the connection between T & U and then make a connection between U & Z. The circuit works the same way but now it sounds like an ambulance.

## Project #44 More Motor Sounds (IV)

**OBJECTIVE:** To show how motion can trigger electronic circuits.

Now remove the connections between U & Z and between V & W, then make a connection between T & U. The circuit works the same way but now it sounds like a familiar song but with static.





# Project #45

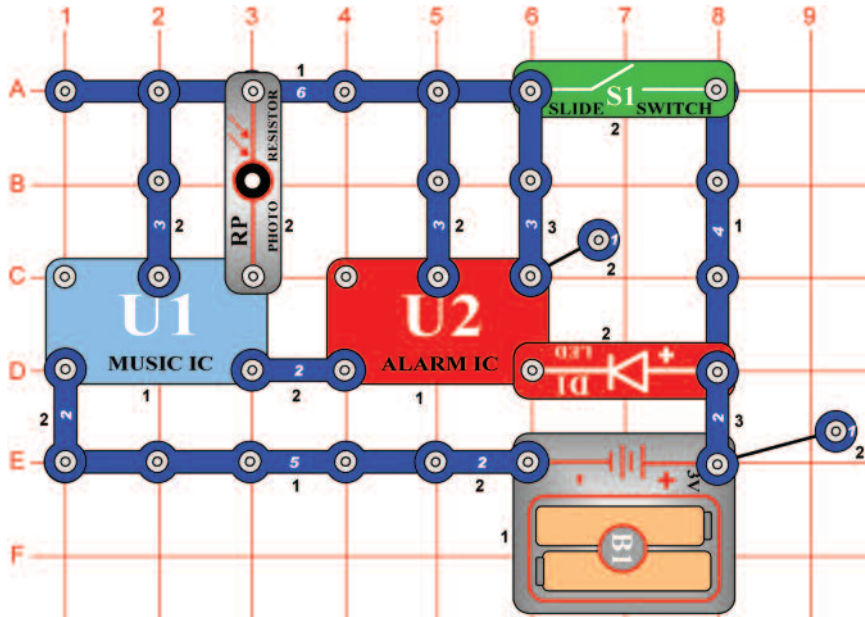

# Light-Controlled Flicker

**OBJECTIVE:** To make a circuit that uses light to control the blinking of another light.

This circuit does not use the noisy speaker (SP) it uses a nice quiet LED (D1). Turn on the slide switch (S1), the LED flickers. Wait a few seconds, then cover the photoresistor (RP) and the flicker stops. The flicker is controlled by the photoresistor, uncover it and the flicker resumes.

People who are deaf need lights to tell them when a doorbell is ringing. They also use circuits like this to tell them if an alarm has been triggered or an oven is ready.

Can you think of other uses?



# Project #46

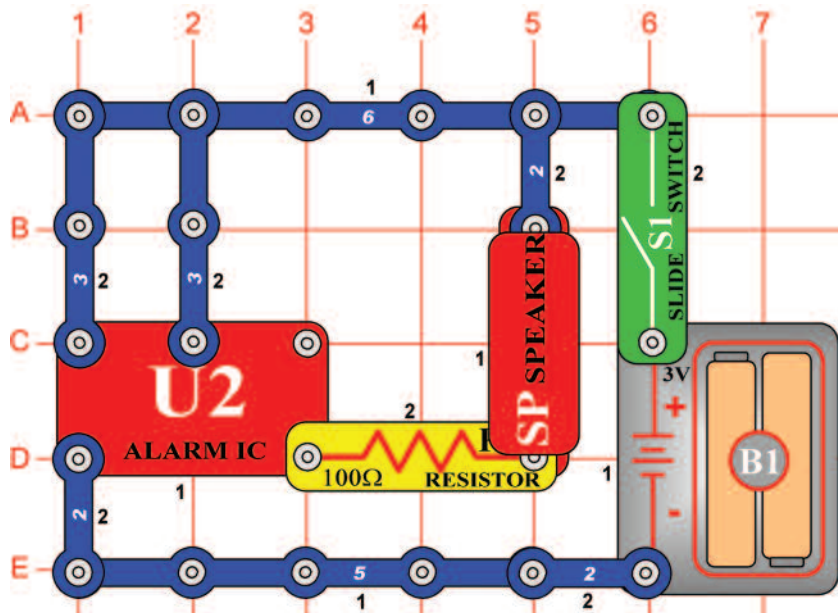

# More Sound Effects

**OBJECTIVE:** To investigate the different sound effects available from the alarm integrated circuit.

Build the circuit shown on the left. When you close the slide switch (S1), the integrated circuit (U2) should start sounding an up-down siren. This is just one more sound effect that this integrated circuit is designed to produce. Different sounds that can easily be changed are very important when designing games and toys. Switch the sound on and off quickly and see if you can create even different effects. This mode will create many robotic sounds if switched quickly.



# Project #47

# This OR That

**OBJECTIVE:** To introduce you to the OR concept of electronic wiring.

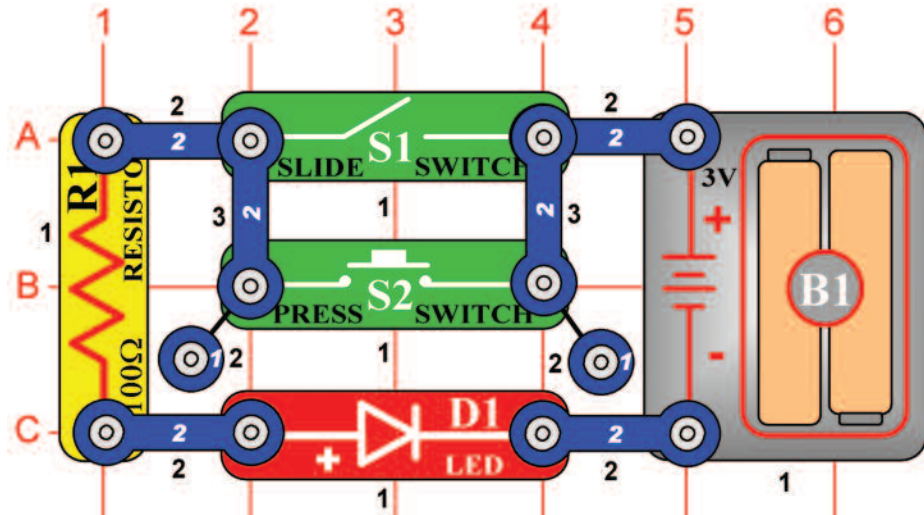

Build the circuit shown. Notice that if you turn on the slide switch (S1) OR press the press switch (S2) the LED (D1) lights up. There is no partially lit state here, the diode is either totally on or totally off. While this may seem very simple and boring, it represents an important concept in electronics. Two switches like this may be used to turn on a light in your house, or they might be two sensors at a railroad crossing used to start the ding-ding sound and lower the gate. You could also have more than two switches and the circuit would function the same way.



# Project #48

# This AND That

**OBJECTIVE:** To introduce you to digital circuits.

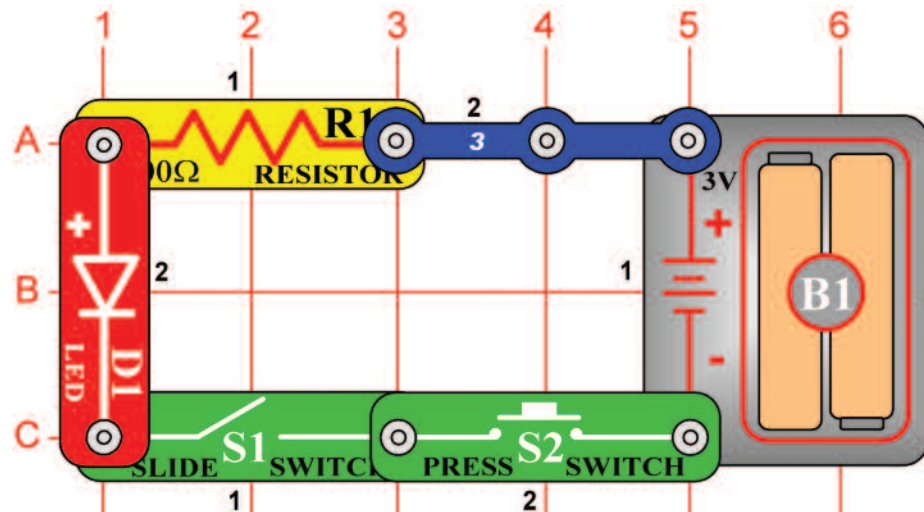

Build the circuit shown. Notice that if you turn on the slide switch (S1) AND press the press switch (S2) the LED (D1) lights up. Once again, there is no partially lit state here, the LED is either totally on or totally off. Two switches like this may be used to turn on the same light in your house, the room switch and the master switch in the electrical box. You could also have more than two switches and the circuit would function the same way.

Combinations of AND and OR circuits are used to add and multiply numbers together in modern computers. These circuits are made of tiny transistors in massive integrated circuits.



# Project #49

# Neither This NOR That

*OBJECTIVE: To demonstrate the concept of a NOR circuit.*

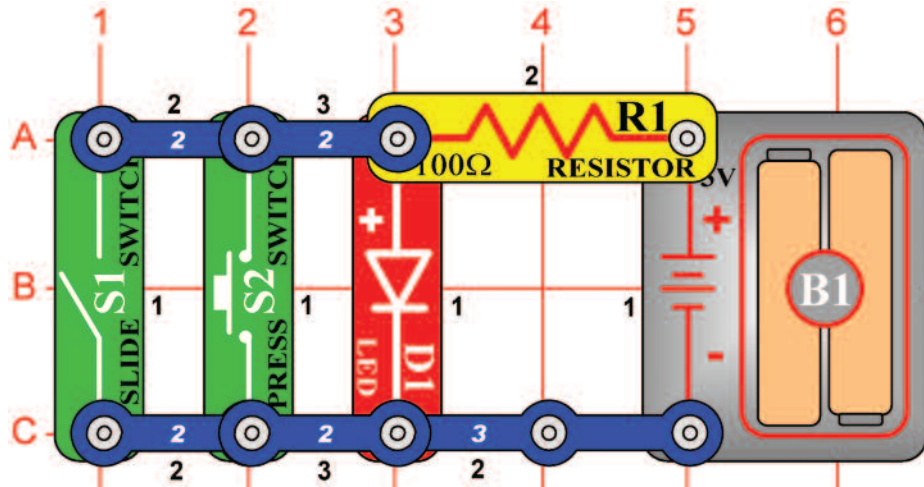

Build the circuit at left and test the combinations of the slide switch (S1) and press switch (S2). If you compare it to the OR circuit in Project #47, you can see the LED lights in the opposite combinations of that circuit. Hence, we refer to it as a NOR circuit (short for “NOT this OR that”). Like the OR and AND, it is an important building block in computers.



# Project #50

# NOT This AND That

*OBJECTIVE: To demonstrate the concept of a NAND circuit.*

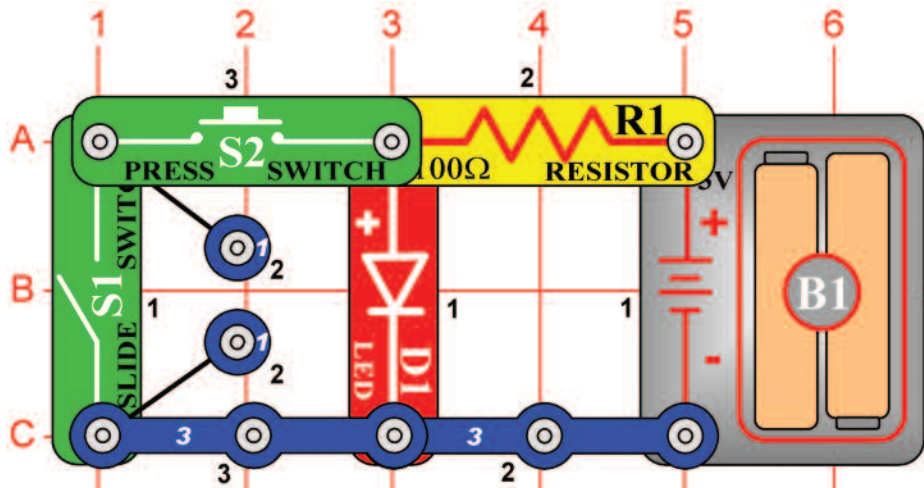

Build the circuit at left and test the combinations of the slide switch (S1) and press switch (S2). If you compare it to the AND circuit in Project #48, you can see the LED (D1) lights in the opposite combinations of that circuit. Hence, we refer to it as a NAND circuit (short for “NOT this AND that”). This circuit can also have more or less than two inputs, though when it only has one input it is referred to as a NOT circuit. Like the OR, AND, and NOR, NAND and NOT are important building blocks in computers.





## Project #51

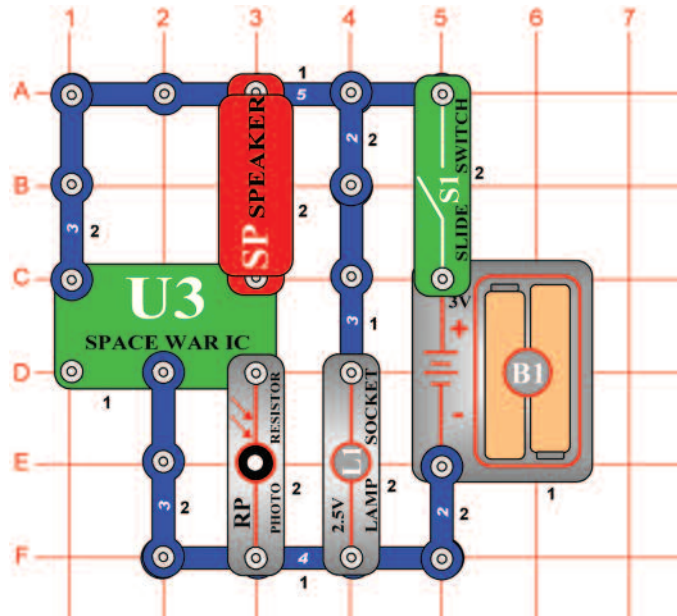

## Reflection Detector

**OBJECTIVE:** To detect if a mirror is present.

Build the circuit at left. Place it where there won't be any room light hitting the photoresistor (RP) (such as in a dark room or under a table), and then turn it on. The 2.5V lamp (L1) will be bright, but there should be no sound.

Take a small mirror and hold it over the lamp and photoresistor. You should hear sound now. You have a reflection detector! You can also use a white piece of paper instead of a mirror, since white surfaces reflect light.



## Project #52

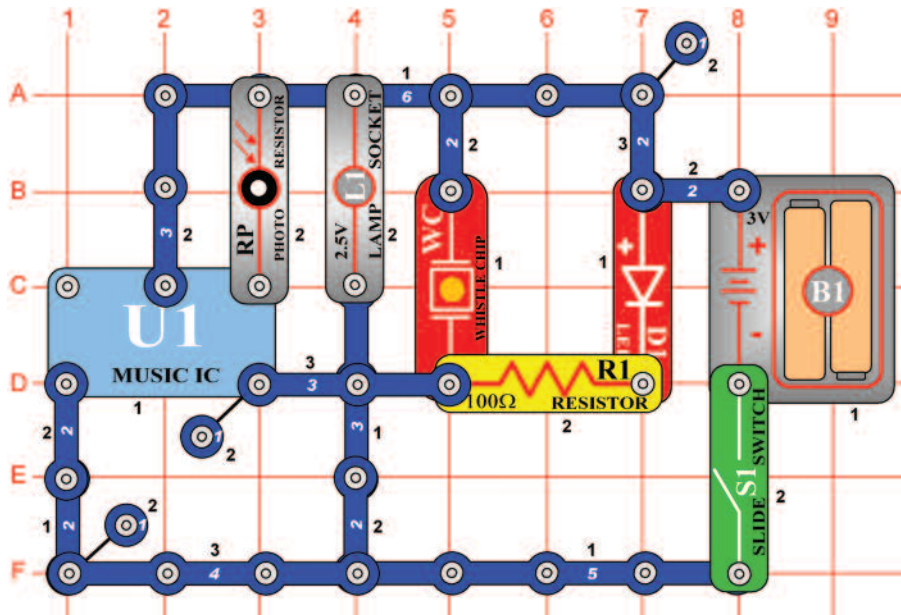

## Quieter Reflection Detector

**OBJECTIVE:** To detect a mirror.

Build the circuit at left. Place it where there won't be any room light hitting the photoresistor (RP) (such as in a dark room or under a table), and then turn it on. The 2.5V lamp (L1) will be bright and one song may play, but then there should be no sound.

Take a small mirror and hold it over the lamp and photoresistor. You should hear sound now. You have a reflection detector! You can also use a white piece of paper instead of a mirror, since white surfaces reflect light.



# Project #53

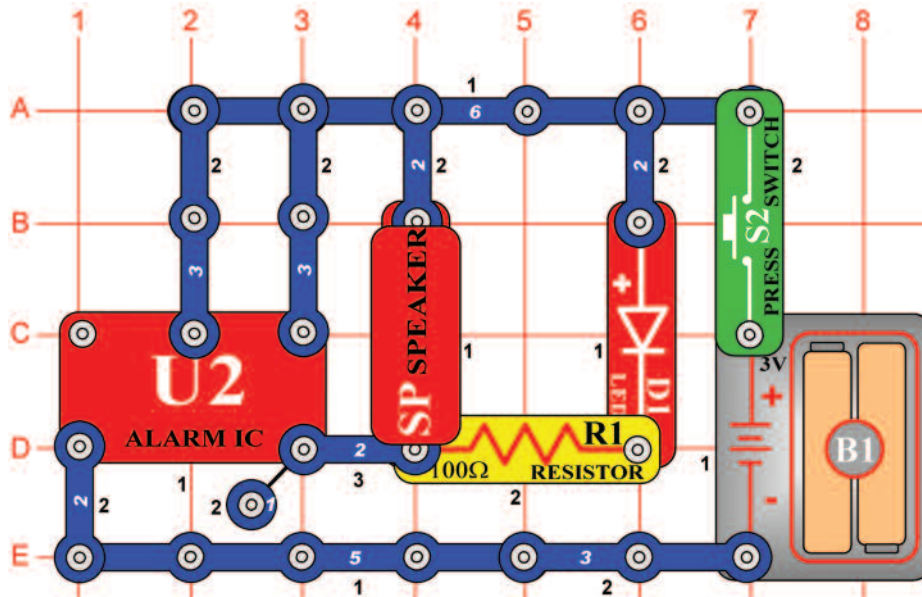

# Flashing Laser Light with Sound

**OBJECTIVE:** To build the circuit used in a toy laser gun with flashing laser light and trigger.

When you press the press switch (S2), the integrated circuit (U2) should start sounding a very loud laser gun sound. The red LED will flash simulating a burst of laser light. You can shoot long repeating laser burst, or short zaps by tapping the press switch.



# Project #54

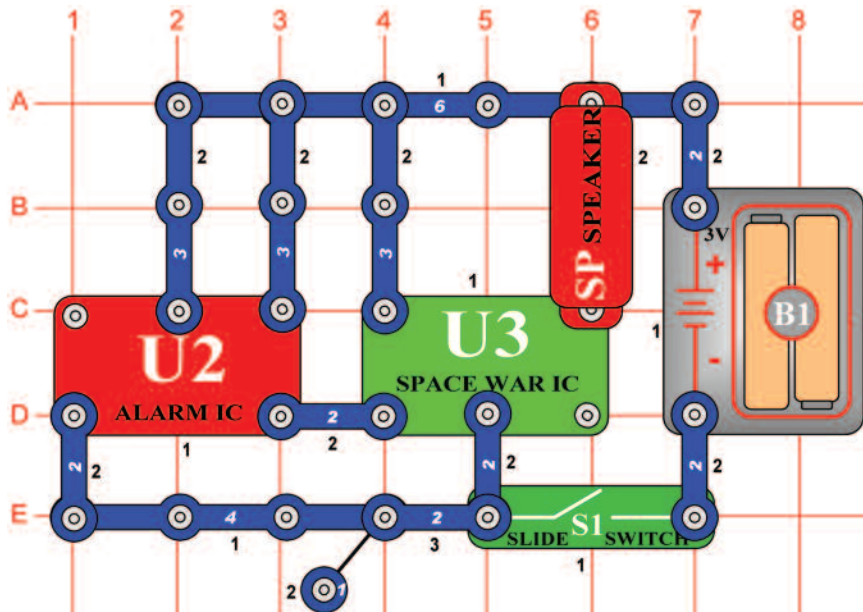

# Space War Flicker

**OBJECTIVE:** To build a circuit using the space war IC to make exciting sounds.

Build the circuit shown on the left, which uses the Space War integrated circuit (U3).

Set the slide switch (S1) on and the speaker (SP) makes exciting sounds. The output of the IC can control lights, speakers, and other low power devices.

You may replace the speaker with the 2.5V lamp (L1), and the bulb will flicker. You can also use the LED (D1) in place of the lamp (position it with the "+" side towards the 6-snap).

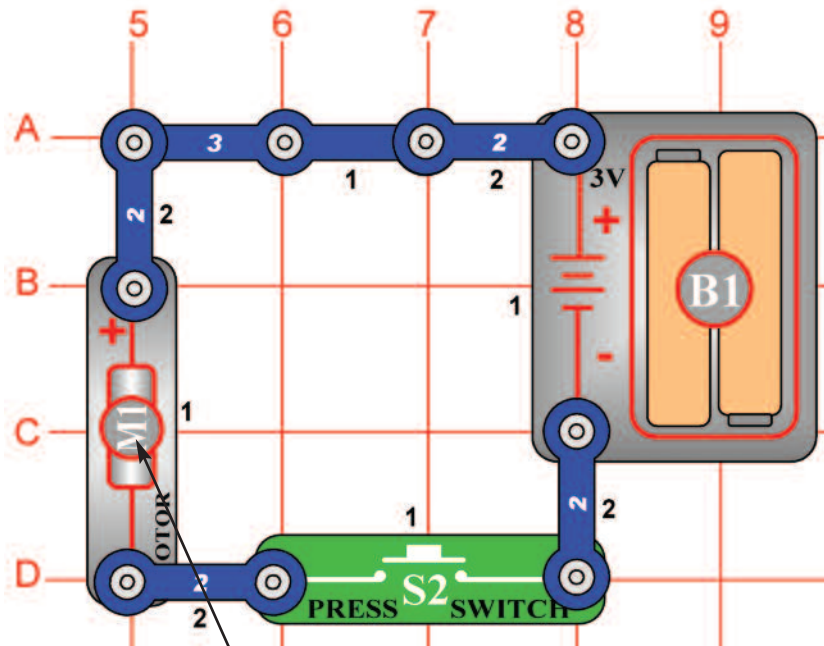

## Project #55 Spinning Rings

**OBJECTIVE:** To build an electronic spinner.

**Setup:** Cut out the disc on page 46 that looks like the one shown here. Using Scotch tape, attach the disc with the printed side up on the top of the fan blade. Place the blade on the motor (M1) as shown to the left and below.

When the press switch (S2) is pressed, the arcs will turn into colored rings with a black background. Notice how the color drops in brightness when it is stretched to make a complete circle.

**WARNING:** Moving parts. Do not touch the fan or motor during operation. Do not lean over the motor.

## Project #56 Strobe the House Lights

**OBJECTIVE:** To use the spinner to see strobe effect due to 60 cycles.

Use the circuit from Project #55.

**Setup:** Place the spinning rings under a fluorescent light that runs on normal house current. Start the disc spinning and release the press switch (S2). As the speed changes you will notice the white lines first seem to move in one direction then they start moving in another direction. This effect is because the lights are blinking 60 times a second and the changing speed of the motor is acting like a strobe light to catch the motion at certain speeds. To prove this, try the same test with a flashlight. The light from a flashlight is constant and if all other lights are out, you will not see the effect that looks like a helicopter blade in a movie. Some fluorescent lights use an electronic ballast and they also produce a constant light.



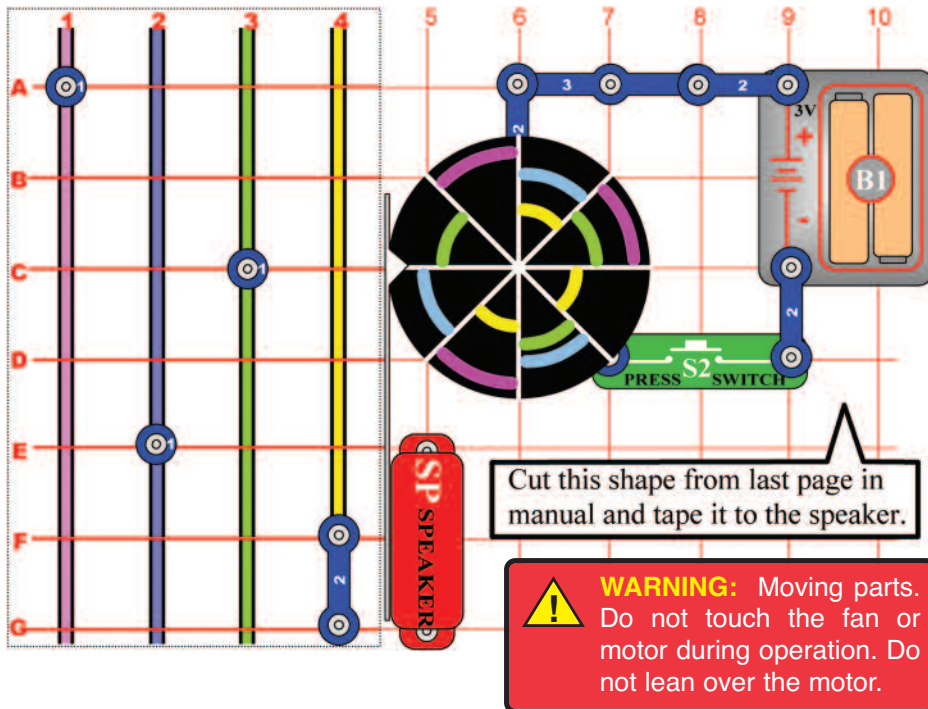

# Project #57

## Race Game

**OBJECTIVE:** Build an electronic game for racing.

Modify Project #56 by adding the pointer as shown on the left. The paper should be cut from page 46 and taped high enough on the speaker (SP) so the pointer will stick over the fan (M1) with paper. Bend the pointer at a right angle as shown on the left.

**Setup:** Cut out the grid with four (4) colors from page 46 and place it under the base as shown on the left. Each player picks a color (or two colors if only 2 people are playing) and places a single snap on row G. The purple player in column 1, the blue player in column 2, the green player in column 3, and the yellow player in column 4. Spin the wheel by closing the press switch (S2). The first single color wedge that the pointer points to is the first player to start. In some models, you only have three 1-snaps, so use a 2-snap if you have four players.

**The Play:** Each player gets a turn to press the press switch. They release the press switch and when the pointer points to a wedge the players that match the colors on the wedge get to move up one space. If a liner comes up like the one shown on the left then the players on each side of the line get to move up two (2) spaces. The first player to reach the top row (A) wins. If two players reach the top row at the same time they must both drop down to row "D" and play continues.



# Project #58

## Using Parts as Conductors

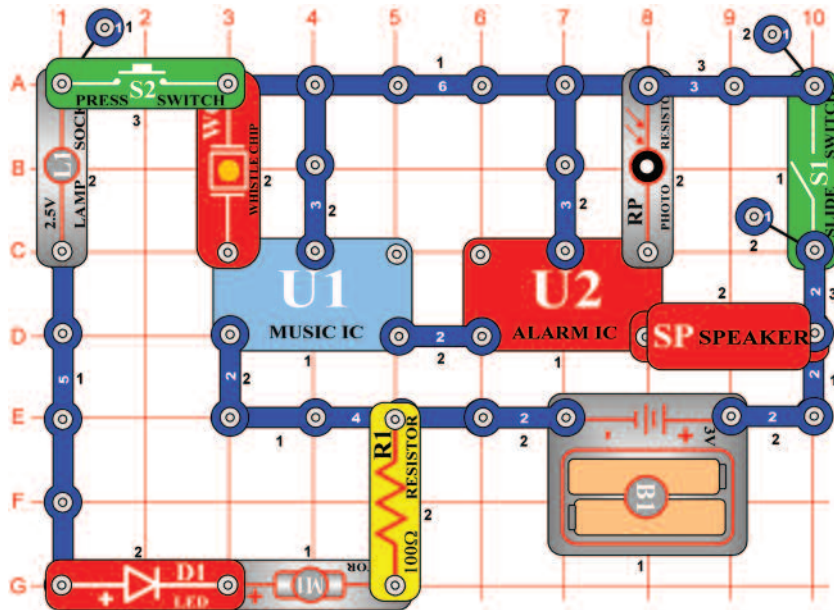

**OBJECTIVE:** To show that motors and lamps may sometimes be used as ordinary conductors.

Turn on the slide switch (S1) and tap the whistle chip (WC), it makes a machine gun sound (with music in the background). Thoroughly cover the photoresistor (RP) with your hand and the sound becomes a siren. After a while the sound will stop, tap the whistle chip and it resumes.

Press the press switch (S2) and the LED (D1) lights, but the lamp (L1) does not light and the motor (M1) does not spin. Electricity is flowing through the lamp and motor, but not enough to turn them on. So in this circuit they are acting like 3-snap wires.

# Project #59

## Spin Draw

**OBJECTIVE:** To produce circular artistic drawings.

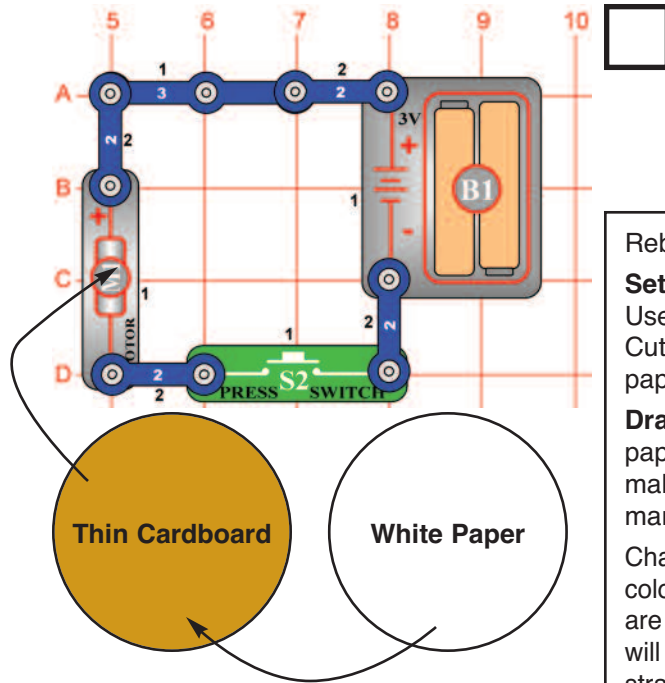

Rebuild the simple motor connection as shown on the left. This is the same setup as Project #57.

**Setup:** Cut out a circular piece of thin cardboard from the back of an old spiral notebook or note pad. Use the fan blade as a guide. Place the fan on the cardboard and trace around it with a pencil or pen. Cut the cardboard out with scissors and tape it to the fan blade. Do the same thing with a piece of white paper, but tape the paper on top of the cardboard so it can be removed easily later.

**Drawing:** To make a ring drawing obtain some thin and thick marking pens as drawing tools. Spin the paper by pressing and holding press switch (S2) down. Press the marker on the paper to form rings. To make spiral drawings, release press switch and as the motor (M1) approaches a slow speed move the marker from the inside outward quickly.

Change the colors often and avoid using too much black to get hypnotic effects. Another method is to make colorful shapes on the disc then spin the disc and watch them blend into each other. When certain speeds are reached under fluorescent lights without electronic ballasts, the strobe principle shown in another project will produce strange effects and backward movement. Make a wheel with different colored spokes to see this strange effect. Adding more spokes and removing spokes will give different effects at different motor speeds.

# Project #60

# Space War Flicker Motor

**OBJECTIVE:** To run the motor using the space war IC.

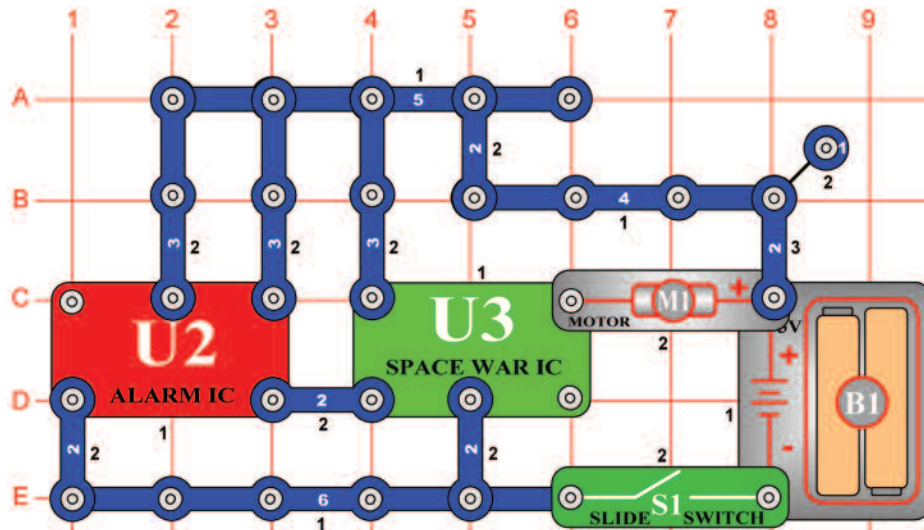

Turn on the slide switch (S1) and the motor (M1) spins (you may need to give it a push with your finger to get it started). The sounds from the space war IC (U3) are used to drive the motor. Because the motor uses magnets and a coil of wire similar to a speaker, you may even hear the space war sounds coming faintly from the motor.



# Project #61

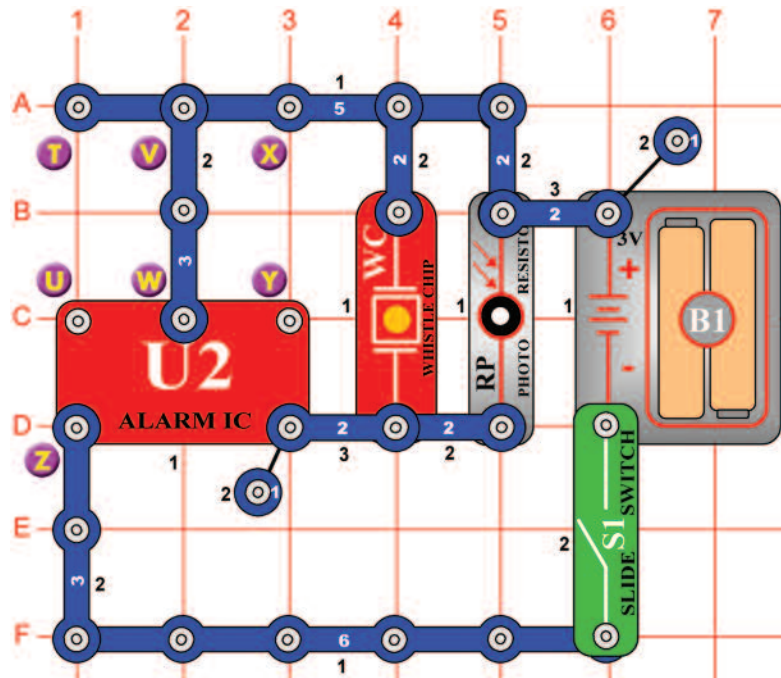

# Light-Controlled Sounds

**OBJECTIVE:** To give a more dramatic demonstration of using the photosensitive resistance.

Build the circuit shown on the left.

Turn on the slide switch (S1), a police siren is heard. The loudness of the sound depends on how much light reaches the photoresistor (RP), try partially shielding it or placing near a very bright light, and compare the sound.



## Project #62 Light-Controlled Sounds (II)

**OBJECTIVE:** To show a variation of the circuit in Project #61.

Modify the last circuit by connecting points X & Y. The circuit works the same way but now it sounds like a machine gun.



## Project #63 Light-Controlled Sounds (III)

**OBJECTIVE:** To show a variation of the circuit in Project #61.

Now remove the connection between X & Y and then make a connection between T & U. The circuit works the same way but now it sounds like a fire engine.



## Project #64 Light-Controlled Sounds (IV)

**OBJECTIVE:** To show a variation of the circuit in Project #61.

Now remove the connection between T & U and then make a connection between U & Z. The circuit works the same way but now it sounds like an ambulance.



## Project #65 Light-Controlled Sounds (V)

**OBJECTIVE:** To show a variation of the circuit in Project #61.

Now remove the connection between U & Z, add a 1-snap at Z (on level 3), add a second 3-snap between V & W (on level 3), and finally place the music IC (U1) directly over the alarm IC (U2) on level 4. Listen to the sounds.

# Project #66

# Electronic Bombing Game

*OBJECTIVE: To make an electronic bombing game.*

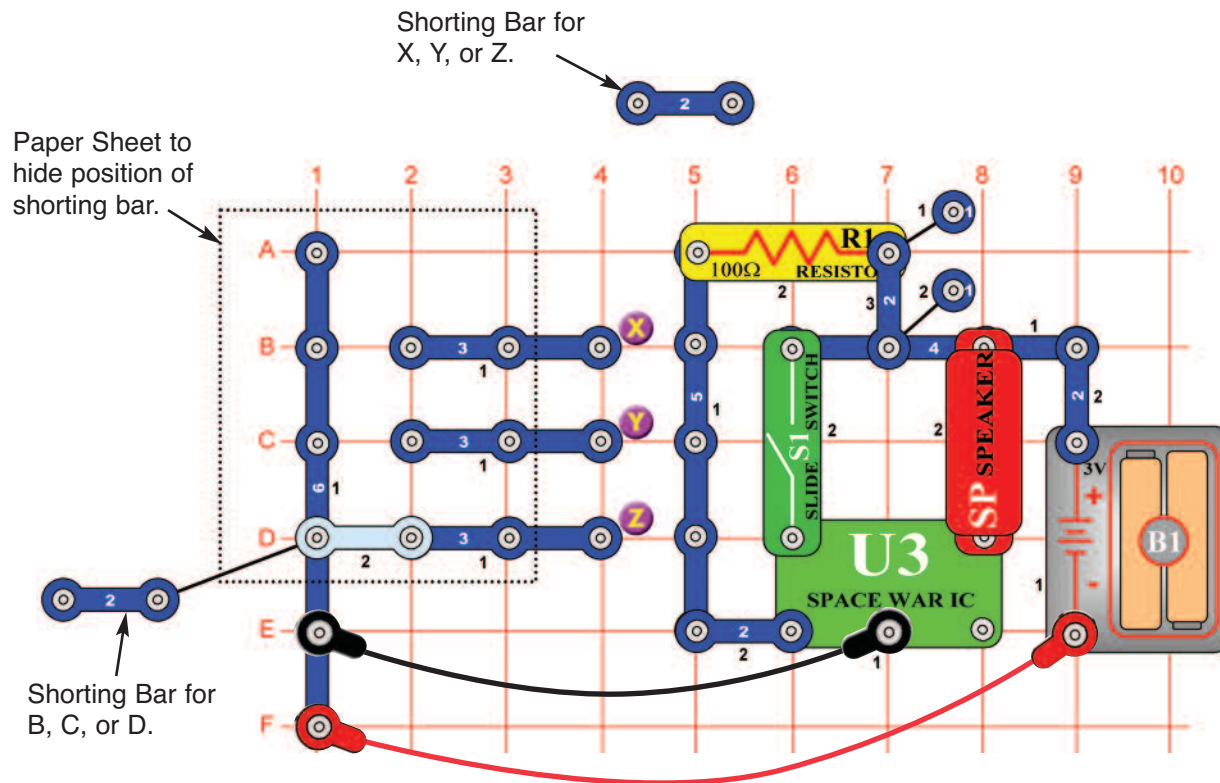

Build the circuit at left. It uses both jumper wires as permanent connections. It also uses two 2-snap wires as “shunting bars”.

**Setup:** Player 1 sets the target by placing one shunting bar under the paper on row B, C, or D. Player 2 must NOT know where the shunting bar is located under the paper.

The object is for Player 2 to guess the location by placing their shunting bar at positions X, Y, or Z. In the drawing on the left Player 1 set up this hole at position “D”. If Player 2 places their shunting bar across “Z” on the first try then they get a hit. They keep guessing until they hit. After each hit, remove the shunting bars and slide the switch off and on to reset the sound.

Player 2 then sets the B, C, D side and player 1 tries their luck.

Play multiple rounds and see who gets the best overall score. The winner will be the player who is best at reading their opponent’s mind.





# Project #67

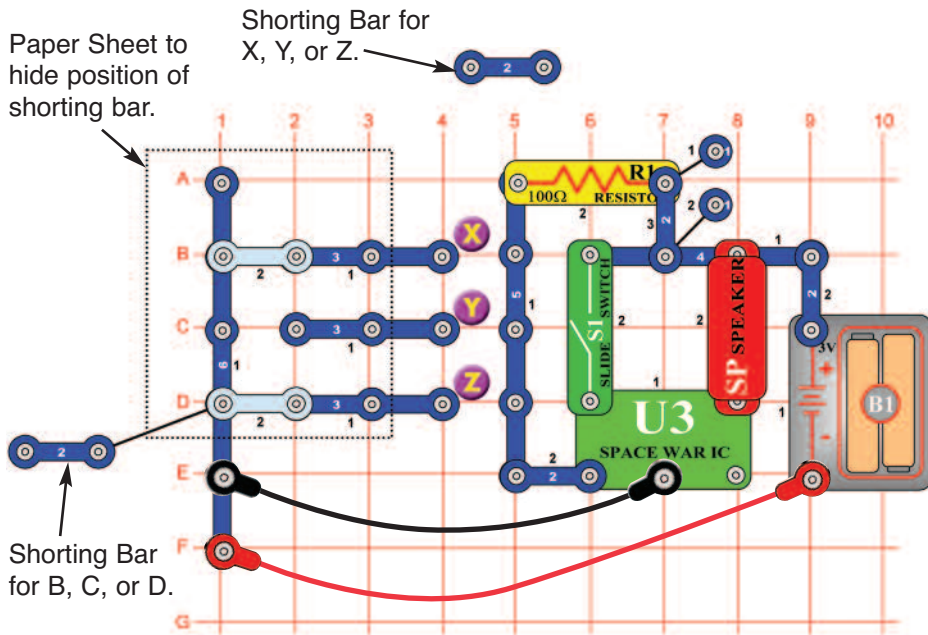

# Quiet Zone Game

**OBJECTIVE:** Make and play the electronic game of “Quiet Zone”.

Use the circuit from Project #66, but place two 2-snap wires (“shorting bars”) under the paper sheet as shown on left.

**Setup:** Player 1 sets the “Quiet Zone” by placing 2 shorting bars under the paper on row A, B, C, or D, leaving only one open. Player 2 must NOT know where the shorting bars are located under the paper.

Both Player 1 and Player 2 are given 10 points. The object is for Player 2 to guess the location of the “Quiet Zone” by placing their shorting bar at positions X, Y, or Z. In the drawing on the left, Player 1 set up the “Quiet Zone” at position “C”. If Player 2 places their shorting bar across “Z” on the first try, the sounds played mean they have not found the “Quiet Zone” and they lose 1 point. They have three (3) tries to find the zone on each turn. Each time sounds are made, they lose a point. Player 2 then sets the B, C, D side and player 1 starts searching. Play continues until one player is at zero points and makes sound during that player’s turn.



# Project #68

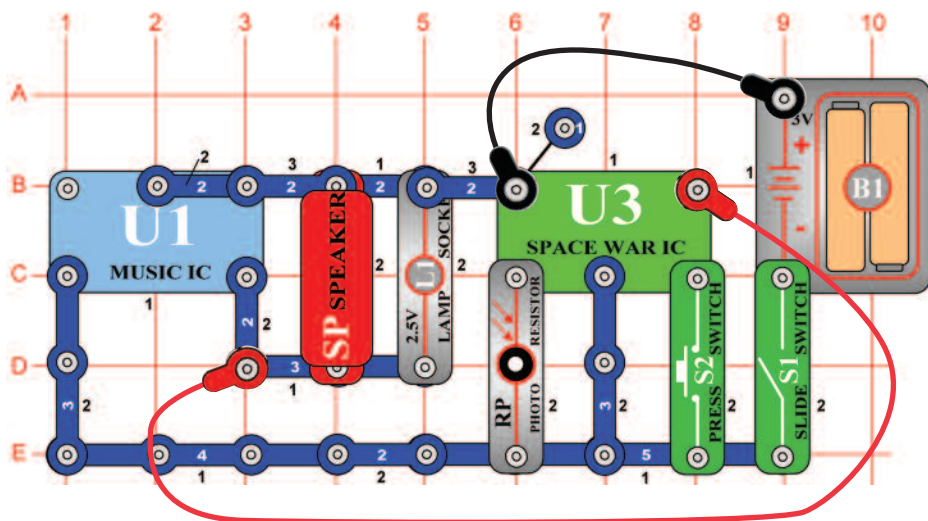

# Space War Music Combo

**OBJECTIVE:** To combine the sounds from the space war and music integrated circuits.

Build the circuit shown and add the jumpers to complete it. Turn it on, press the press switch (S2) several times, and wave your hand over the photoresistor (RP) to hear all the sound combinations. If the sound is too loud you may replace the speaker (SP) with the whistle chip (WC).



# Project #69

# Space War Siren

**OBJECTIVE:** To combine effects from the space war and alarm integrated circuits.

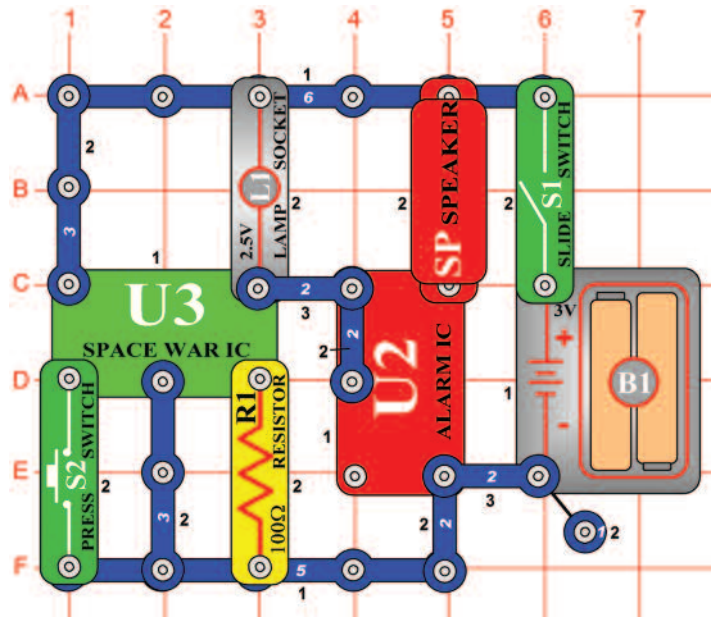

Build the circuit shown on the left and turn on the slide switch (S1). Press and hold the press switch (S2) to make the lamp (L1) brighter.



# Project #70

# Quiet Water Alarm

**OBJECTIVE:** To sound an alarm when water is detected.

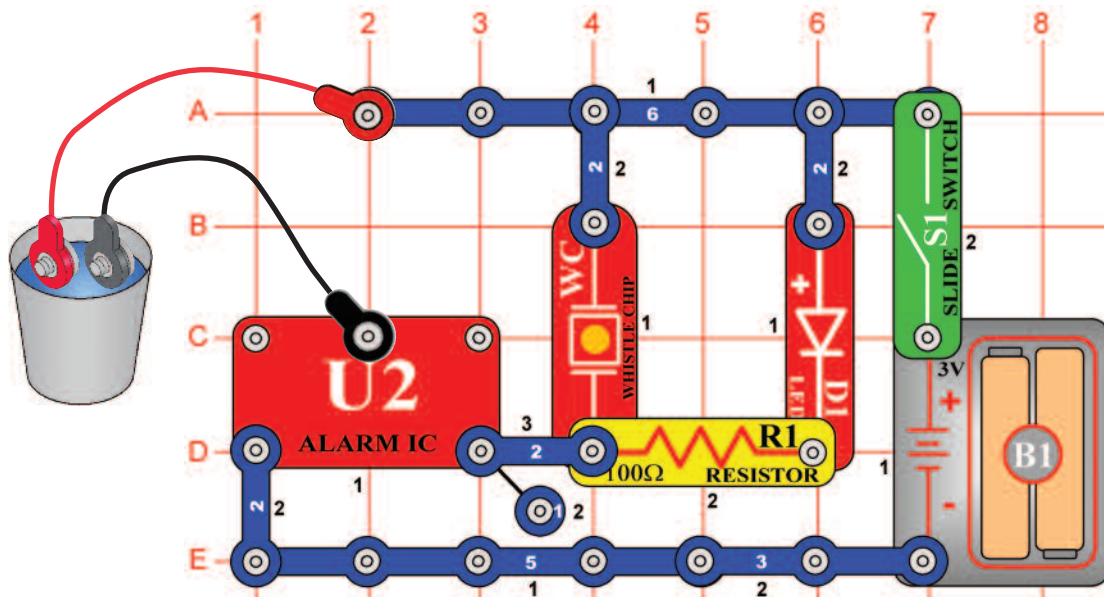

Sometimes you want a water alarm that can be heard but is not loud enough to be annoying or distracting, so let's make one. We'll also put a light on it that could be seen in a noisy room, in a real application you could use a powerful light that would be easily seen.  
Build the circuit shown but initially leave the jumper wires outside the cup. Turn on the slide switch (S1); nothing happens. Place the jumper wires into a cup of water and an alarm sounds and the light comes on.



## Project #71

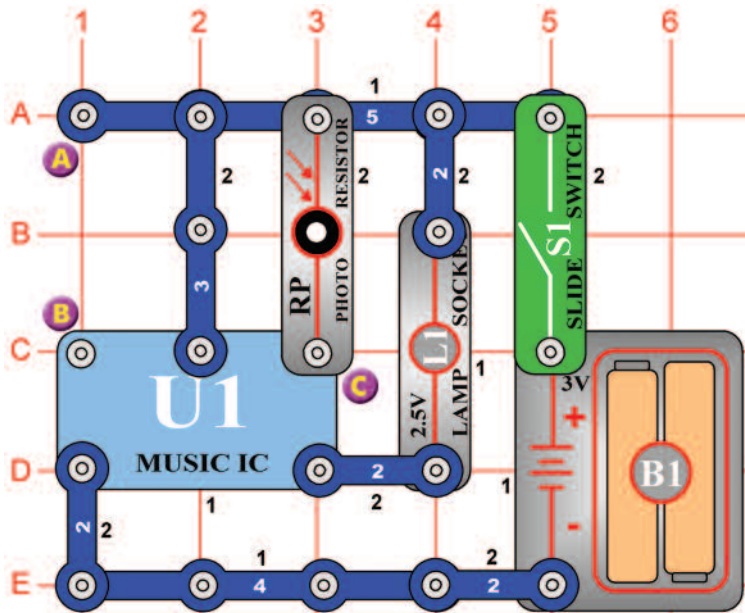

## Light-Controlled Lamp

*OBJECTIVE: To turn a lamp on and off using light.*

Cover the unit, turn the slide switch (S1) on, and notice that the lamp (L1) is off after a few seconds. Place the unit near a light and the lamp turns on. Cover the photoresistor (RP) and place it in the light again. The lamp will not turn on. The resistance of the photoresistor decreases as the light increases. The low resistance acts like a wire connecting point C to the positive (+) side of the battery (B1).



## Project #72

### Voice-Controlled Lamp

*OBJECTIVE: To turn a lamp on and off using the voltage generated from a photoresistor.*

Use the circuit from Project #71. Remove the photoresistor (RP) and connect the whistle chip (WC) across points A & B. Turn the slide switch (S1) on and clap your hands or talk loud near the whistle chip (WC), the lamp will light. The whistle chip has a piezocrystal between the two metal plates. The sound causes the plates to vibrate and produce a small voltage. The voltage then activates the music IC (U1) and turns the lamp on.



## Project #73

### Motor-Controlled Lamp

*OBJECTIVE: To turn a lamp on and off using the voltage generated when a motor rotates.*

Use the circuit from Project #72. Remove the whistle chip (WC) and connect the motor (M1) across points A & B. Turn the slide switch (S1) on and turn the shaft of the motor and the lamp (L1) will light. As the motor turns, it produces a voltage. This is because there is a magnet and a coil inside the motor. When the axis turns the magnetic field will change and generate a small current in the coil and a voltage across its terminals. The voltage then activates the music IC (U1).



## Project #74

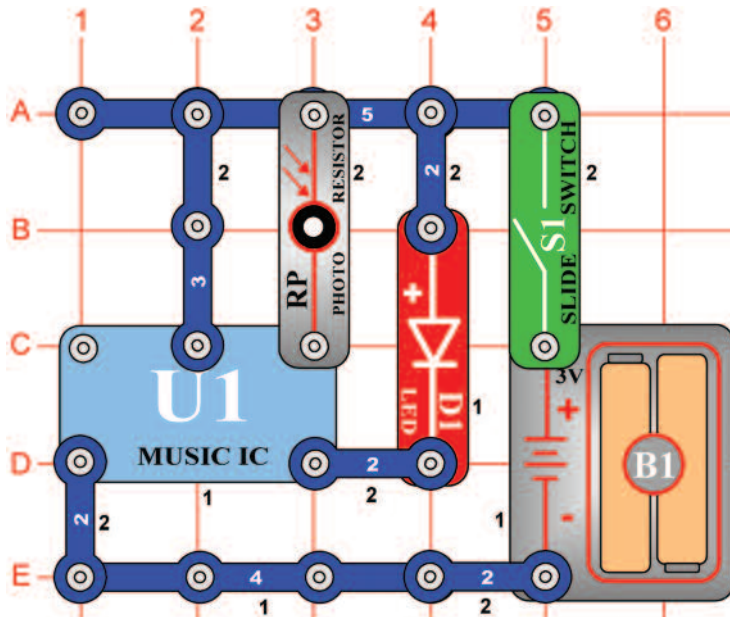

## Light-Controlled LED

**OBJECTIVE:** To control an LED using light.

Cover the unit, turn the slide switch (S1) on, and notice that the LED (D1) is on for a few seconds and then goes off. Place the unit near a light and the LED will light. Cover the photoresistor (RP) and place it near the light again. The LED will not turn on. The resistance of the photoresistor decreases as the light increases.



## Project #75 Sound-Controlled Time Delay LED

**OBJECTIVE:** To control an LED using sound.

Use the circuit from Project #74. Connect the whistle chip (WC) to points A1 and C1 on the base grid, then remove the photoresistor (RP). Turn the slide switch (S1) on and clap your hands or talk loud near the whistle chip, the LED (D1) will light. The whistle chip has a piezocrystal between the two metal plates. The sound causes the plates to vibrate and produce a small voltage. The voltage then activates the music IC (U1).



## Project #76 Motor-Controlled Time Delay LED

**OBJECTIVE:** To control an LED using a motor.

Use the circuit from Project #75. Remove the whistle chip (WC) and connect the motor (M1) across points A1 and C1 on the base grid. Turn the slide switch (S1) on and turn the shaft of the motor and the LED (D1) will light. As the motor turns, it produces a voltage. There is a magnet and a coil inside the motor. When the axis turns, the magnetic field will change and generate a small current across its terminals. The voltage then activates the music IC (U1).



# Project #77 Space War Flicker LED

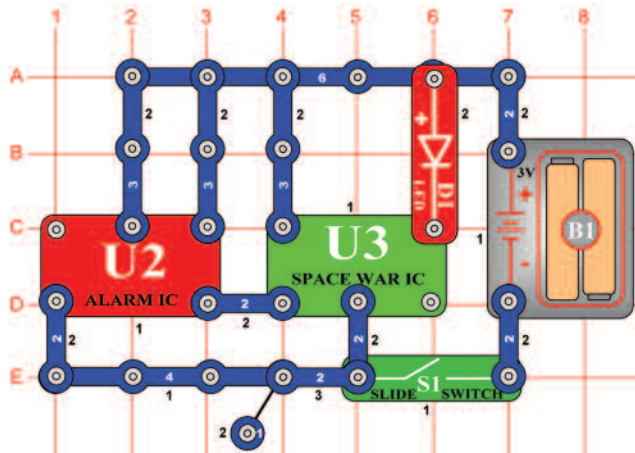

**OBJECTIVE:**  
Flash an LED using the space war IC.

Build the circuit shown on the left. The circuit uses the alarm (U2) and space war (U3) ICs to flash the LED (D1). Turn the slide switch (S1) on and the LED starts flashing.

# Project #78 Music AND Gate

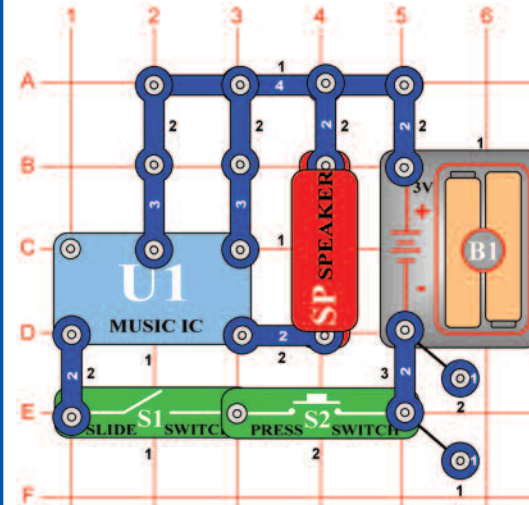

**OBJECTIVE:**  
To build an AND gate.

You will only hear music if you turn on the slide switch (S1) AND press the press switch (S2). This is referred to as an AND gate in electronics. This concept is important in computer logic.  
**Example:** If condition X AND condition Y are true, then execute instruction Z.

# Project #79 Flash and Tone

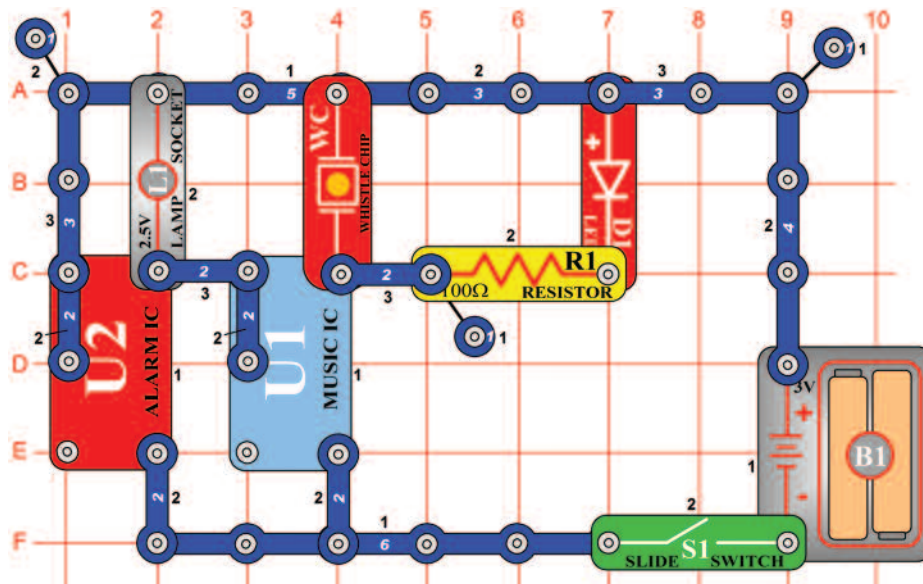

**OBJECTIVE:** Build a circuit that flashes light and plays sounds.

Turn the slide switch (S1) on and the lamp (L1) and LED (D1) start flashing. You hear two different tones driving the LED and lamp. ICs can be connected to control many different devices at the same time.



# Project #80

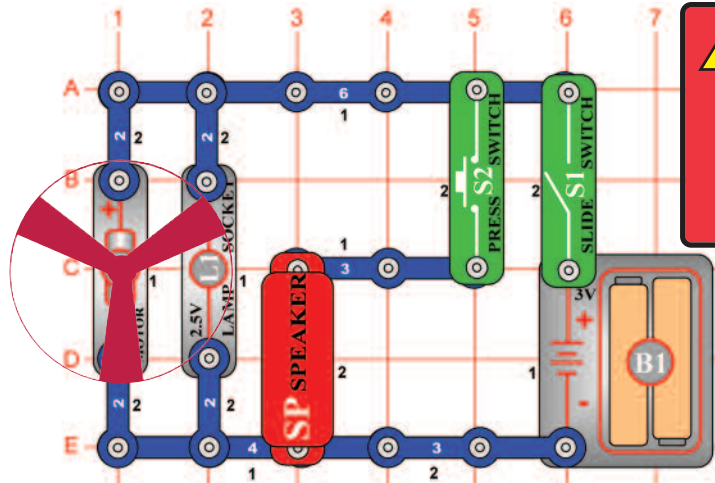

**WARNING:**  
 Moving parts. Do not touch the fan or motor during operation. Do not lean over the motor.

# Lamp, Speaker & Fan in Parallel

**OBJECTIVE:** To show the power drop of components connected in parallel.

Leave the fan off the motor (M1). Turn on the slide switch (S1), the motor spins and the lamp (L1) turns on. Place the fan on the motor and press the press switch. The lamp is not as bright now, because it takes more power from the batteries (B1) to spin the motor with the fan on it, which leaves less battery power available to light the lamp. If you have weak batteries, the difference in lamp brightness will be more obvious because weaker batteries don't have as much power to supply.

The speaker (SP) is being used as a low-value resistance here to make the above effects more apparent.



# Project #81

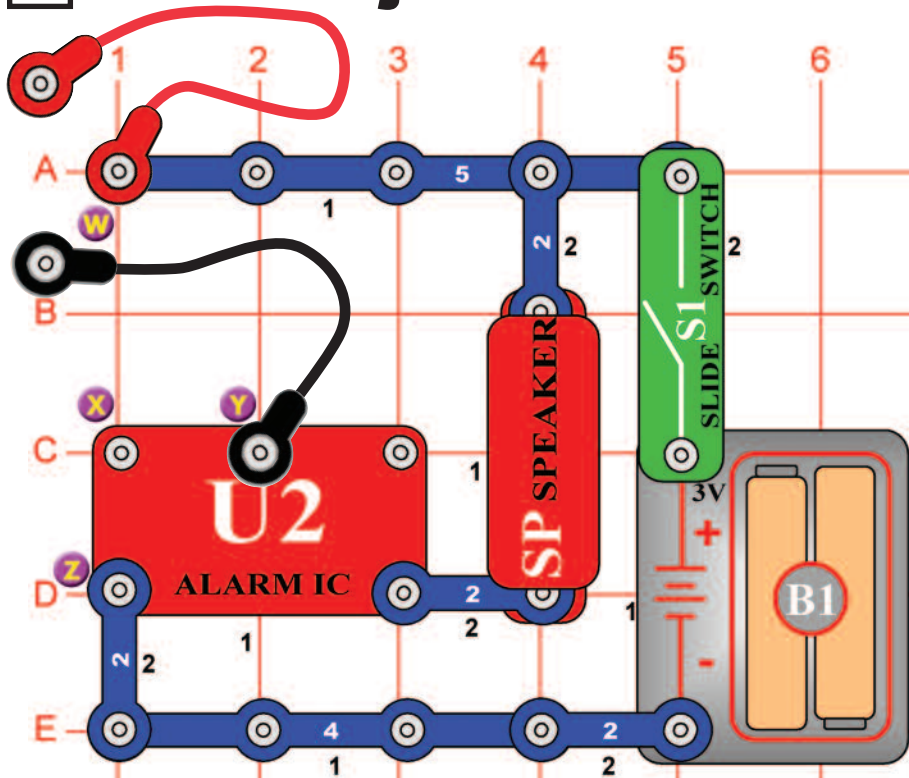

# Pencil Alarm

**OBJECTIVE:** To draw an alarm activator.

Build the circuit shown and connect the two jumpers to it, leave the loose ends of the jumpers unconnected for now. There is one more part you need and you are going to draw it. Take a pencil (No. 2 lead is best but other types will also work). **SHARPEN IT**, and fill in the shape below. You will get better results if you place a **hard**, flat surface directly beneath this page while you are drawing. Press **hard** (but don't rip the paper), and fill in the shape **several times** to be sure you have a **thick, even layer** of pencil lead.

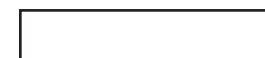

Turn on the slide switch (S1) and take the loose ends of the jumpers, press them to the shape and move them around over the drawing. If you don't hear any sound then move the ends closer together and move over the drawing, add another layer of pencil lead, or put a drop of water on the jumper ends to get better contact.



# Project #82 Pencil Alarm Variants

**OBJECTIVE:** To draw an alarm activator.

Remove the jumper connected to point Y (as shown in the drawing) and connect it to point X instead. Touch the loose ends to the pencil drawing again, the sound is different now.

Next connect a 2-snap wire between points X & Y connect the jumper to either point. Touch the loose ends to the pencil drawing again, you hear a different sound.

Now remove the 2-snap wire between X & Y and connect it between X & Z, connect the jumpers to W & Y. Touch the loose ends to the pencil drawing again, you hear yet another sound.

Now you can draw your own shapes and see what kinds of sounds you can make.



# Project #83

# Fun with the Alarm IC

**OBJECTIVE:** To show some new ways of using the alarm IC.

Build the circuit shown and place the fan on the motor (M1), but leave the jumpers off for the time being. Turn on the slide switch (S1) and tap the whistle chip (WC), it makes a machine gun sound (with music in the background). Thoroughly cover the photoresistor (RP) with your hand and the sound becomes a siren. With the photoresistor covered, press the press switch (S2) and the sound becomes that of an ambulance. Uncover the photoresistor and the sound remains that of a machine gun whether the press switch is pressed or not. After a while the sound will stop, tap the whistle chip and it resumes.

Connect the two jumpers as shown and tap the whistle chip to resume the sound. The lamp (L1) and LED (D1) light and the motor spins. The sound continues, but it may become distorted as the motor speeds up. The motor draws a lot of power from the batteries (B1), and this may reduce the voltage to the music (U1) and alarm (U2) ICs, distorting the sound. The sound may even stop if your batteries are weak.

**WARNING:** Moving parts. Do not touch the fan or motor during operation. Do not lean over the motor.

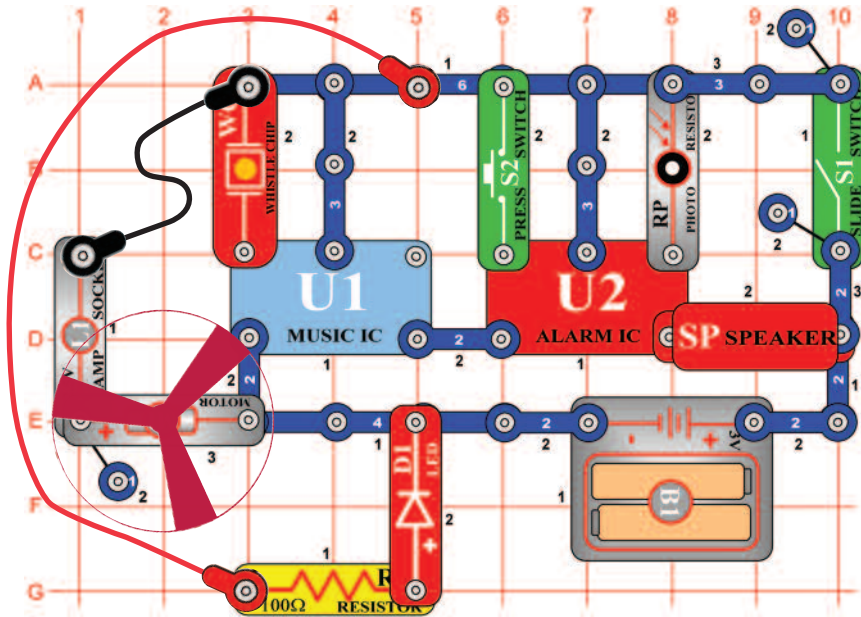

# Project #84

## Motor Sounds Combo

**OBJECTIVE:** To connect multiple devices together.

In the circuit, the outputs from the alarm and music ICs are connected together. Build the circuit shown and then place the alarm IC (U2) directly over the music IC (U1), resting on two 1-snaps and a 2-snap. Turn on the slide switch (S1) and you will hear a siren and music together while the lamp (L1) varies in brightness. Push the press switch (S2) and the fan spins, while the sound may not be as loud. The fan may rise into the air when you release the press switch.

**WARNING:** Moving parts. Do not touch the fan or motor during operation. Do not lean over the motor.

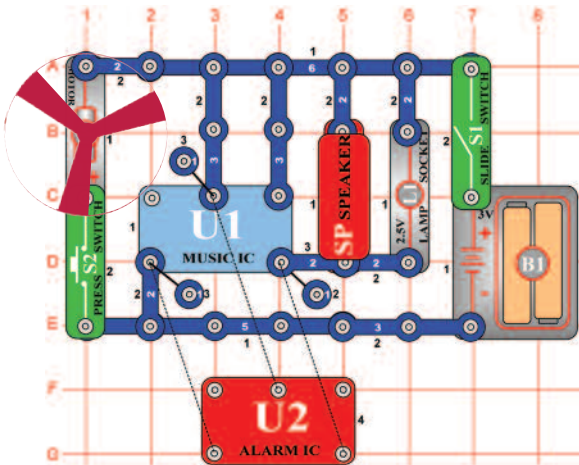

# Project #85

## Motor Sounds Combo (II)

**OBJECTIVE:** To connect multiple devices together.

In the circuit, the outputs from the alarm and music ICs are connected together. Build the circuit shown and then place the alarm IC (U2) directly over the music IC (U1), resting on three 1-snaps. Turn on the slide switch (S1) and you will hear a siren and music together. Push the press switch (S2) and the fan spins, while the sound may not be as loud. The fan may rise into the air when you release the switch.

This circuit is similar to project #84, but the fan will fly a little higher since the sound circuit no longer drives the lamp (L1) and therefore uses less battery power.

**WARNING:** Moving parts. Do not touch the fan or motor during operation. Do not lean over the motor.

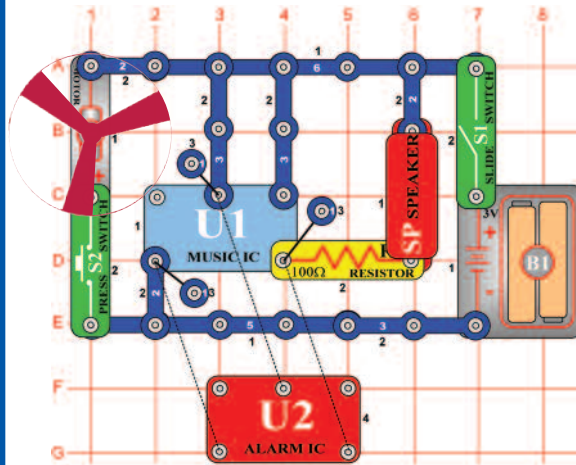





## Project #86

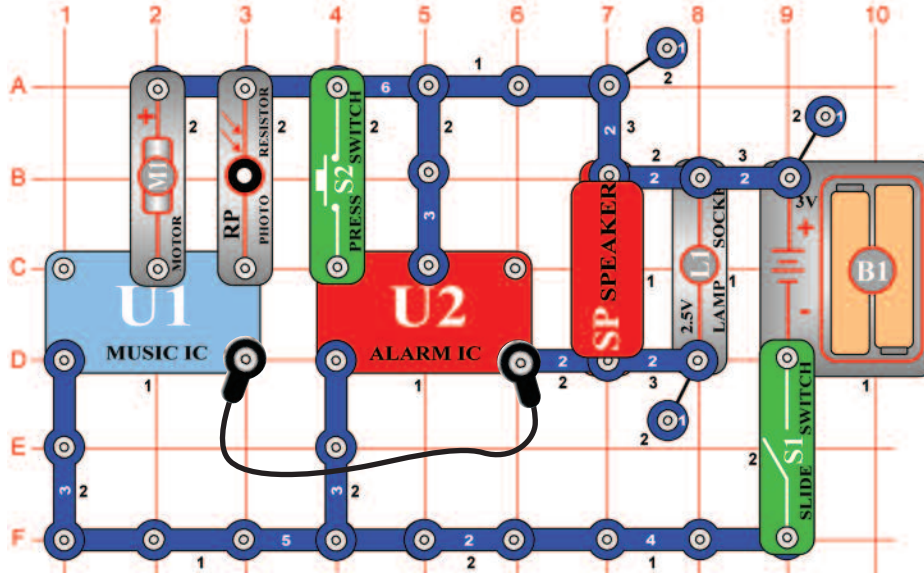

## Music Alarm Combo

**OBJECTIVE:** To combine the sounds from the music and alarm integrated circuits.

Build the circuit shown and add the jumper to complete it. Turn it on and you will hear a siren and music together. Press the press switch (S2) and the siren changes to a fire engine sound. After a few seconds, covering the photoresistor (RP) will stop the music (but the siren continues). The motor (M1) is used here as a 3-snap wire and will not spin.



## Project #87

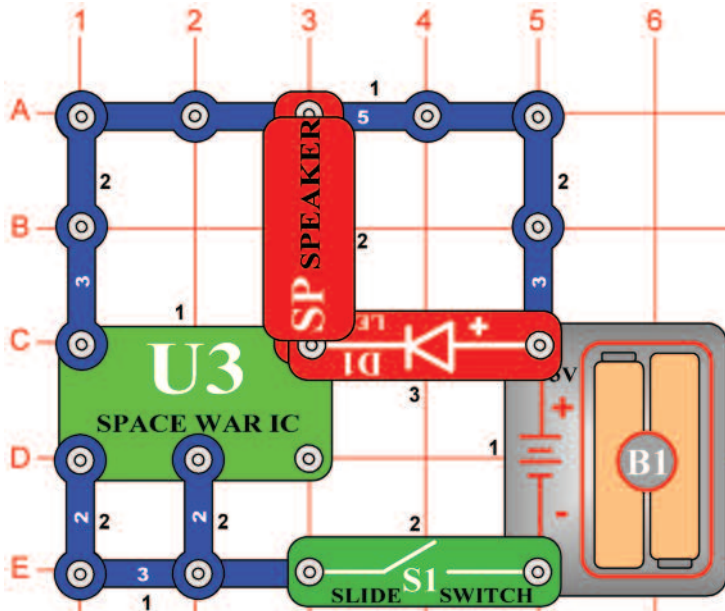

## Bomb Sound

**OBJECTIVE:** Build a circuit that sounds like a bomb dropping.

Turn the slide switch (S1) on and you hear the sound of a bomb dropping and then exploding. The LED (D1) lights and then flashes as the bomb explodes. This is one sound generated from the space war IC (U3).



## Project #88 Bomb Sound (II)

**OBJECTIVE:** Build a circuit that sounds like bombs dropping.

Use the circuit from Project #87. Replace the slide switch (S1) with the motor (M1). Turn the shaft on the motor and now it sounds like a bunch of bombs dropping.





## Project #89

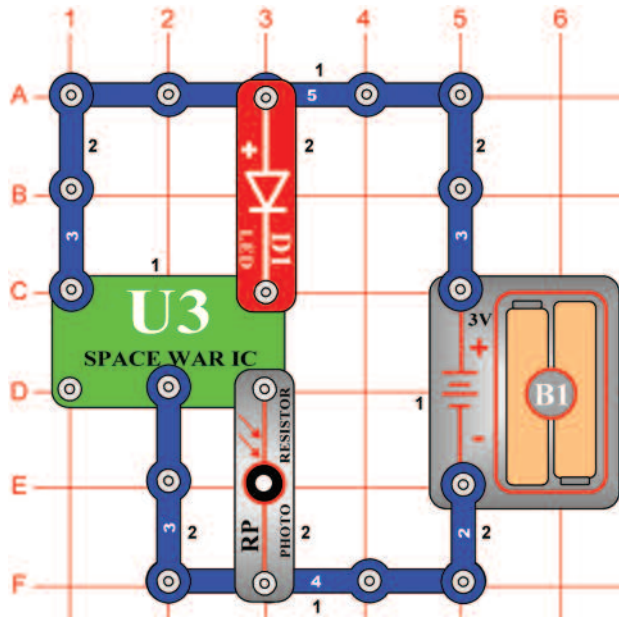

## Light-Controlled LED (II)

**OBJECTIVE:** Build a circuit that turns an LED on and off if there is light present.

When there is light on the photoresistor (RP), the LED (D1) will flicker. Shield the photoresistor from the light, the LED should turn off.



## Project #90 Touch Light

**OBJECTIVE:** Build a circuit that turns on and off an LED using the whistle chip.

Use the circuit from Project 89. Replace the photoresistor (RP) with the whistle chip (WC). Tap on the whistle chip and the LED (D1) flickers. Tap again and the LED may flicker for a longer time. See how long the LED will stay on.



## Project #91 Touch Sound

**OBJECTIVE:** Build a circuit plays sound if you tap on the whistle chip.

Use the circuit from Project #90. Replace the LED (D1) with the speaker (SP). Now you can hear the different sound as you tap on the whistle chip (WC).



## Project #92

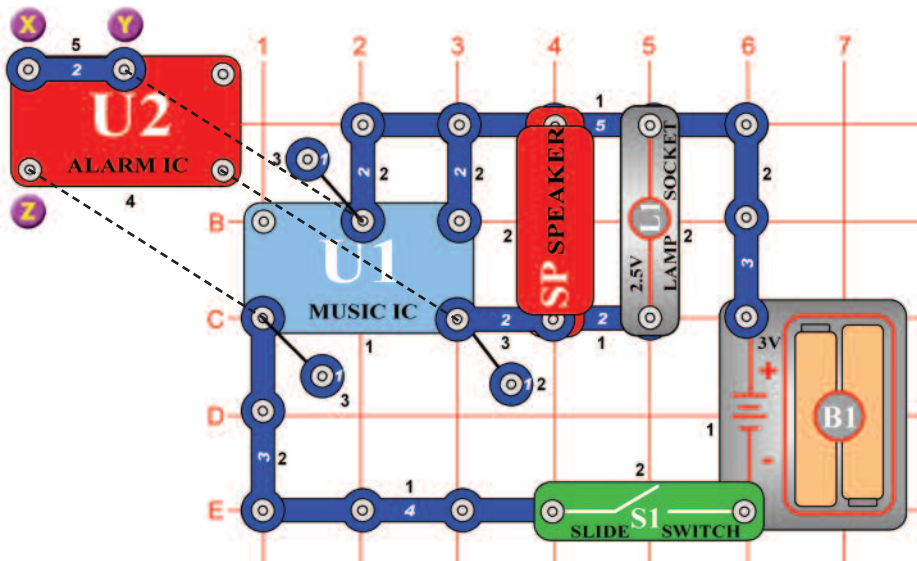

## Wacky Sounds

**OBJECTIVE:** To combine different sounds.

In the circuit, the outputs from the alarm and music ICs are connected together. Build the circuit shown and then place the alarm IC (U2) directly over the music IC (U1), resting on two 1-snaps and a 2-snap. There is also a 2-snap on top of the alarm IC. Turn on the switch (S1) and you will hear a siren and music together while the lamp (L1) varies in brightness.



## Project #93 Wackier Sounds

**OBJECTIVE:** To combine different sounds.

Now remove the 2-snap connection between X & Y and then make a 2-snap connection between X & Z (on level 5). The circuit works the same way but has different sounds.



## Project #94

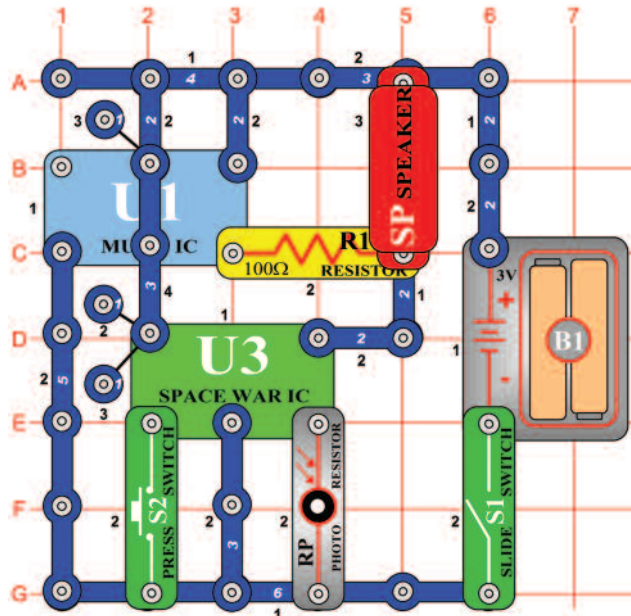

## Really Wacky Sounds

**OBJECTIVE:** To combine different sounds.

Build the circuit shown. Turn it on, press the press switch (S2) several times, and wave your hand over the photoresistor to hear all the sound combinations. You can make the sound from the music IC louder by replacing the 100 $\Omega$  resistor (R1) with the 2.5V lamp (L1).



## Project #95

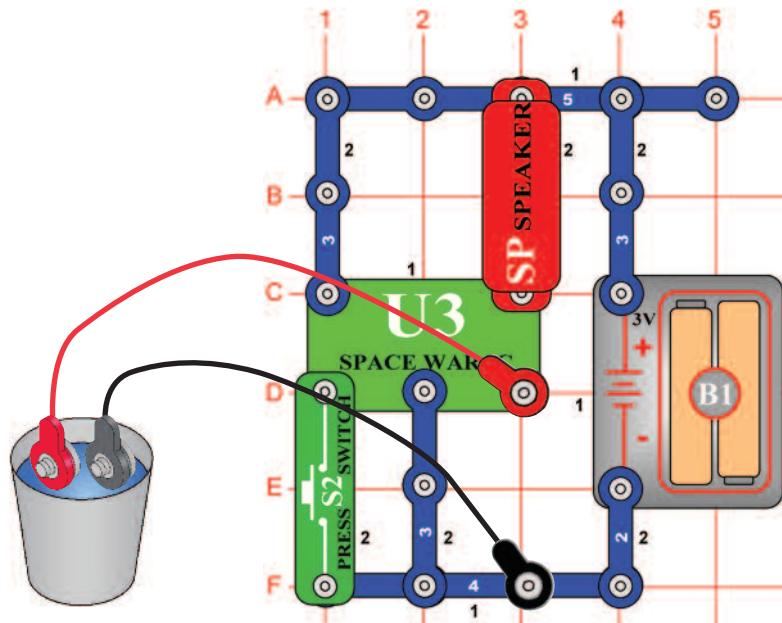

## Noisier Water Space War

**OBJECTIVE:** To use water to control the space war integrated circuit.

Add the press switch (S2) to the preceding circuit to make it look like the one at left. There will be sound if the press switch is pressed or the jumper wires are in the water.  
Pressing the press switch or pulling the jumper wires out of the water changes the sound played.

If you prefer you can just touch the jumper wire metal with your fingers instead of putting the jumpers in the water. Wet your fingers to get better electrical contact.



## Project #96

### Light/Water Space War

**OBJECTIVE:** To use water to control the space war integrated circuit.

Use the circuit from Project #95. Replace the speaker (SP) with the LED (D1), positioning it as in Project #89. Putting the jumper wires in the water OR pressing the press switch (S2) will cause the LED to be bright.



## Project #97

### OR/AND Space War Light

**OBJECTIVE:** To control the space war integrated circuit.

Use the circuit from Project #96. Replace the LED (D1) with the 2.5V lamp (L1). Putting the jumper wires in the water OR pressing the press switch (S2) will cause the lamp to be dimly lit. Putting the jumper wires in the water AND pressing the press switch at the same time will cause the lamp to be much brighter.



## Project #98

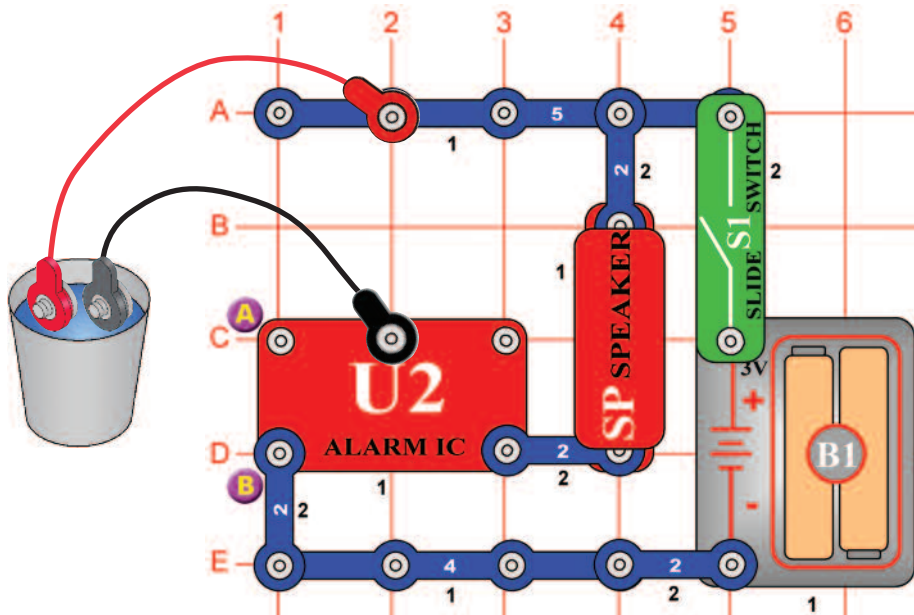

## Simple Water Alarm

**OBJECTIVE:** To sound an alarm when water is detected.

Build the circuit shown but initially leave the jumper wires outside the cup. Turn on the slide switch (S1); nothing happens. Place the jumper wires into a cup of water and an alarm sounds!

You could use longer wires and lay them on your basement floor, if your basement floods during a storm, then this circuit will sound an alarm.



## Project #99 Simple Salt Water Alarm

**OBJECTIVE:** To detect salt water.

Add salt to the water and the tone of the alarm is louder and faster, telling you that salt is in the water you detected. Also, try holding the jumper wires with your fingers to see if your body can set off the alarm.



## Project #100 Ambulance Water Alarm

**OBJECTIVE:** To show a variation of the circuit in Project #98.

Modify the circuit in Project #98 by making a connection between A & B. The water alarm works the same way but now it sounds like an ambulance.



## Project #101 Ambulance Contact Alarm

**OBJECTIVE:** To show a variation of the circuit in Project #98.

The same circuit also detects if the jumper wires get touched together, so connect them to each other. The tone of the sound is now much different. Therefore, this circuit will tell you if there is water between the jumper wires or if the wires are touching each other.



# OTHER SNAP CIRCUITS® PROJECTS!

For a listing of local toy retailers who carry Snap Circuits visit [www.elenco.com](http://www.elenco.com) or call us toll-free at 800-533-2441. For Snap Circuits upgrade kits, accessories, additional parts, and more information about your parts visit [www.elenco.com](http://www.elenco.com).

## Upgrade Kit Model UC-30

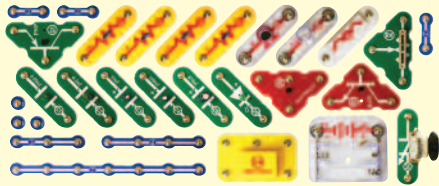

**Build 200 Additional Projects**

**Including:**

- AM Radio
- Water Detector
- Motion Detector
- Electronic Kazoo
- Burglar Alarm
- Tone Generator
- Make Your Own Battery
- Music Radio
- Lie Detector

**Contains 29 New Parts**

**Including:**

- Antenna Coil
- Microphone
- Power Amplifier IC
- Variable Capacitor
- Five Fixed-value Capacitors
- High Frequency IC
- Two Transistors
- Adjustable Resistor
- Four Fixed-value Resistors

## Upgrade Kit Model UC-40



**Build 400 Additional Projects**

**Including:**

- Electronic Cat
- Music Meter
- Adjustable Light Control
- Digitally Tuned FM Radio
- Digital Voice Recorder
- Light Controlled Music
- AC Generator
- Flashing Numbers

**Contains 41 New Parts**

**Including:**

- FM Radio Module
- Analog Meter
- Recording IC Module
- Diode
- 7-Segment LED Display
- Relay
- SCR
- Transformer

## Upgrade Kit Model UC-60

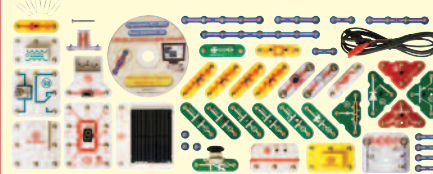

**Build Over 650 Additional Projects**

**Including:**

- Strobe Light
- Electromagnetism
- Electronic Kazoo
- Transistor AM Radio
- Rechargeable Battery
- Solar Batteries
- Mega Pulsar and Flasher
- Paperclip Compass

**Contains 52 New Parts**

**Including:**

- Solar Cell
- Electromagnet
- Vibration Switch
- Two-spring Socket
- Bag of Paperclips
- Includes the **CI-73 Computer Interface**

## Put your circuits in motion! Deluxe Snap Rover® Model SCROV-50



Introducing the next generation of the RC Snap Rover®! This version includes a disc launcher, digital voice recorder, and music sounds. Over 50 parts allow you to complete over 40 additional projects.

- Includes 30 parts
- Build over 20 projects
- Full-color assembly manual
- Sound effects



If you want to enhance your Snap Circuits® experience and get even smarter, then try

## Snap Circuits® Student Guide Jr.

Part # 753294

For use with SC-100

Educational Series - teaches Basic Electricity & Electronics in the everyday world using our Learn By Doing® concept!

48 full-color pages, and written with the help of educators.



## Snap Circuits® Green

### Alternative Energy Kit Model SCG-125

Learn about energy sources and how to "think green". Build over 125 projects and have loads of fun learning about environmentally-friendly energy and how the electricity in your home works. Includes full-color manual with over 100 pages and separate educational manual. This educational manual will explain all the forms of environmentally-friendly energy including: geothermal, hydrogen fuel cells, wind, solar, tidal, hydro, and others. Contains over 40 parts.

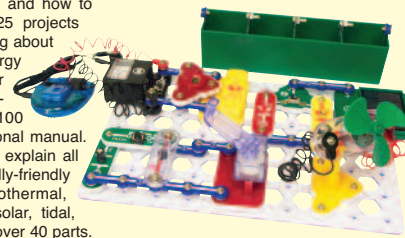

## Snap Circuits® LIGHT

### Model SCL-175

Contains over 60 parts

Build over 175 projects!

**Features:**

- Infrared detector
- Strobe light
- Color changing LED
- Glow-in-the-dark fan
- Strobe integrated circuit (IC)
- Fiber optic communication
- Color organ controlled by iPod® or other MP3 player, voice, and fingers.

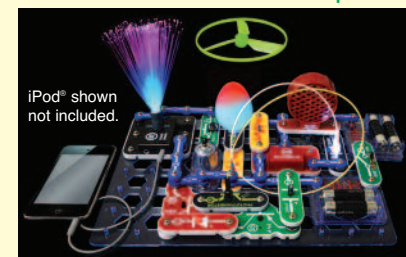

iPod® shown not included.

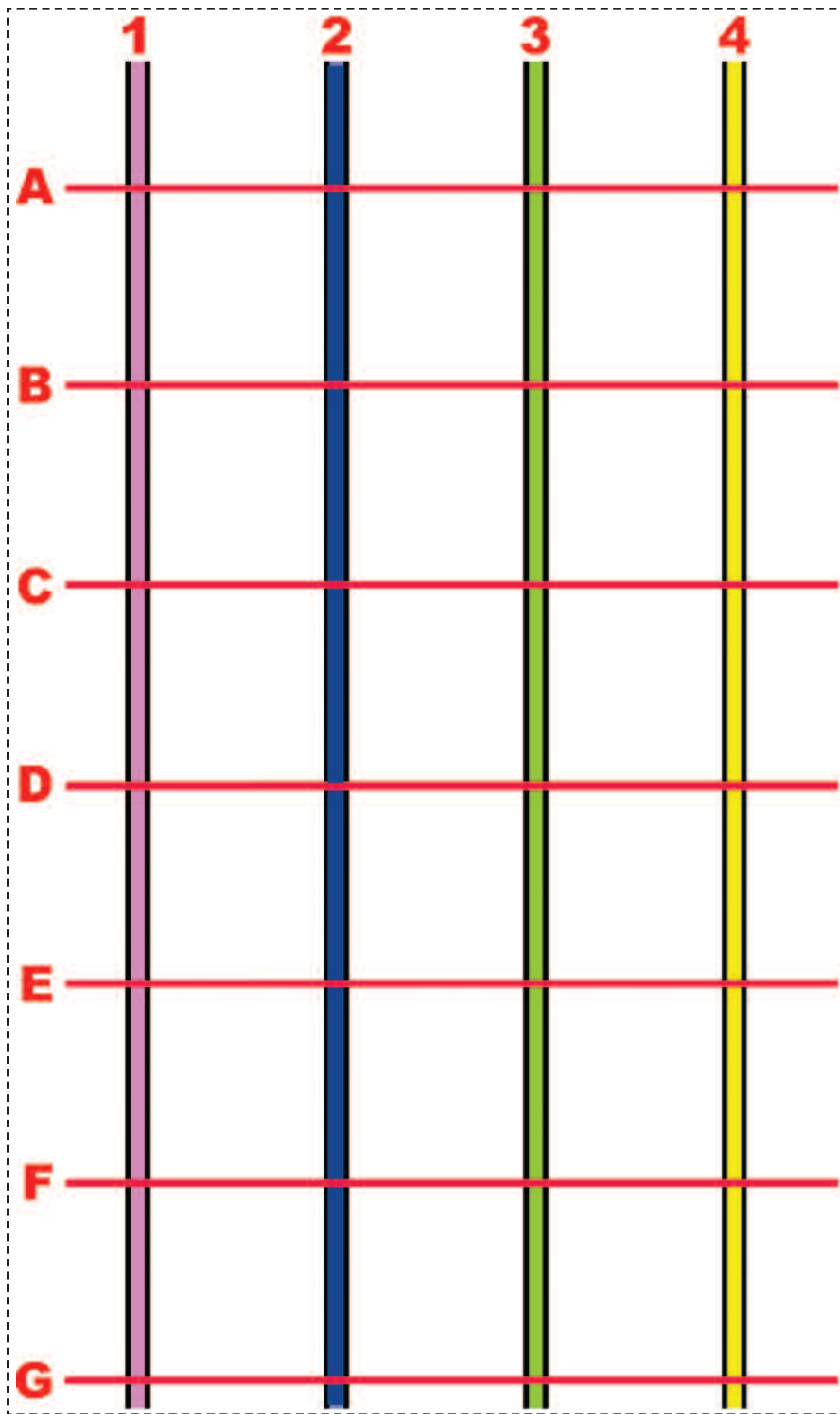

Page 28 for Project #55

← Page 29 for Project #57





**ELENCO®**

150 Carpenter Avenue  
Wheeling, IL 60090  
(847) 541-3800

Website: [www.elenco.com](http://www.elenco.com)  
e-mail: [elenco@elenco.com](mailto:elenco@elenco.com)