

SNAP CIRCUITS[®] XP[™]

Build Your Own Microcomputer!

Instruction Manual

Projects 1-57

SNAP CIRCUITS[®]
ELENCO





Project A3

AGES
10 & up

ELENCO[®]

Table of Contents

Basic Troubleshooting	1	Project Listings	9
Parts List	2	How to Use Snap Circuits®	10
About Your Snap Circuits® Parts	3 - 5	Part A – Introductory Projects (A1-A30)	11 - 27
Introduction to Electricity	6	Part B – Microcontroller Projects (B1-B27)	28 - 58
DO's and DON'Ts of Building Circuits	7	Part C – To Go Further	59
Advanced Troubleshooting	8	Other Snap Circuits® Products	62

 **WARNING TO ALL PROJECTS WITH A  SYMBOL** - Moving parts. Do not touch the motor or fan during operation. Do not lean over the motor. Do not launch the fan at people, animals, or objects. Eye protection is recommended. 

 **WARNING: SHOCK HAZARD** - Never connect Snap Circuits® to the electrical outlets in your home in any way!

 **WARNING: CHOKING HAZARD** - Small parts. Not for children under 3 years.

Conforms to all applicable U. S. government standards.

Requirements for your computer: Windows® XP (or later) or Mac OS X 10.2 (or later) or Linux, 512MB RAM, 500MB of hard-disk space, USB port, and an internet connection.

Basic Troubleshooting

1. Most circuit problems are due to incorrect assembly, always double-check that your circuit exactly matches the drawing for it.
2. Be sure that parts with positive/negative markings are positioned as per the drawing.
3. Be sure that all connections are securely snapped.
4. Try replacing the batteries.
5. If the motor spins but does not balance the fan, check the black plastic piece with three prongs on the motor shaft.

ELENCO® is not responsible for parts damaged due to incorrect wiring.

Note: If you suspect you have damaged parts, you can follow the Advanced Troubleshooting procedure on page 8 to determine which ones need replacing.

WARNING: Always check your wiring before turning on a circuit. Never leave a circuit unattended while the batteries are installed. Never connect additional batteries or any other power sources to your circuits. Discard any cracked or broken parts.

Adult Supervision: Because children's abilities vary so much, even with age groups, adults should exercise discretion as to which experiments are suitable and safe (the instructions should enable supervising adults to establish the experiment's

suitability for the child). Make sure your child reads and follows all of the relevant instructions and safety procedures, and keeps them at hand for reference.

This product is intended for use by adults and children who have attained sufficient maturity to read and follow directions and warnings.





























Never modify your parts, as doing so may disable important safety features in them, and could put your child at risk of injury.

Batteries:

- Use only 1.5V "AA" type, alkaline batteries (not included).
- Insert batteries with correct polarity.
- Non-rechargeable batteries should not be recharged. Rechargeable batteries should only be charged under adult supervision, and should not be recharged while in the product.
- Do not connect batteries or battery holders in parallel.
- Do not mix old and new batteries.
- Do not mix alkaline, standard (carbon-zinc), or rechargeable (nickel-cadmium) batteries.
- Remove batteries when they are used up.
- Do not short circuit the battery terminals.
- Never throw batteries in a fire or attempt to open its outer casing.
- Batteries are harmful if swallowed, so keep away from small children.

Parts List (Colors and styles may vary) Symbols and Numbers

Important: If any parts are missing or damaged, **DO NOT RETURN TO RETAILER.** Call toll-free (800) 533-2441 or e-mail us at: help@elenco.com. Customer Service • 150 Carpenter Ave. • Wheeling, IL 60090 U.S.A.

Qty.	ID	Name	Symbol	Part #	Qty.	ID	Name	Symbol	Part #
□ 1		Base Grid (11.0" x 7.7")		6SCBG	□ 1		Fan Blade		6SCM1F
□ 6	(1)	1-Snap Wire		6SC01	□ 2	(Q2)	NPN Transistor		6SCQ2
□ 9	(2)	2-Snap Wire		6SC02	□ 1	(R1)	100Ω Resistor		6SCR1
□ 4	(3)	3-Snap Wire		6SC03	□ 2	(R2)	1kΩ Resistor		6SCR2
□ 3	(4)	4-Snap Wire		6SC04	□ 2	(R4)	10kΩ Resistor		6SCR4
□ 1	(5)	5-Snap Wire		6SC05	□ 1	(R5)	100kΩ Resistor		6SCR5
□ 1	(6)	6-Snap Wire		6SC06	□ 1	(RP)	Photoresistor		6SCRP
□ 1	(7)	7-Snap Wire		6SC07	□ 1	(RV)	Adjustable Resistor		6SCRV
□ 1	(B3)	Battery Holder - uses 3 1.5V type AA (not Included)		6SCB3	□ 1	(S1)	Slide Switch		6SCS1
□ 1	(C5)	470μF Capacitor		6SCC5	□ 1	(S2)	Press Switch		6SCS2
□ 1	(D1)	Red Light Emitting Diode (LED)		6SCD1	□ 1	(SP)	8 Ohm Speaker		6SCSP
□ 1	(D2)	Green Light Emitting Diode (LED)		6SCD2	□ 1	(U21)	Microcontroller IC		6SCU21
□ 1		Jumper Wire (Black)		6SCJ1	□ 1	(X1)	Microphone		6SCX1
□ 1		Jumper Wire (Red)		6SCJ2	□ 1		Programming Cable		9TLSCXP
□ 1	(M1)	DC Motor		6SCM1					

You may order additional / replacement parts at our website: www.snapcircuits.net

About Your Snap Circuits® XP Parts

(Part designs are subject to change without notice).

BASE GRID

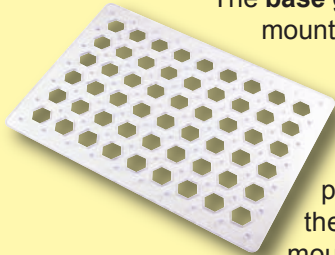

The **base grid** is a platform for mounting parts and wires. It functions like the printed circuit boards used in most electronic products, or like how the walls are used for mounting the electrical wiring in your home.

SNAP WIRES & JUMPER WIRES

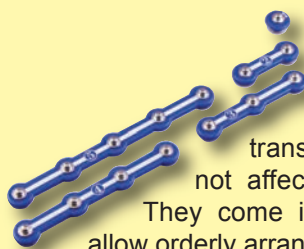

The blue **snap wires** are wires used to connect components. They are used to transport electricity and do not affect circuit performance. They come in different lengths to allow orderly arrangement of connections on the base grid.

The red and black **jumper wires** make flexible connections for times when using the snap wires would be difficult. They also are used to make connections off the base grid.

Wires transport electricity just like pipes are used to transport water. The colorful plastic coating protects them and prevents electricity from getting in or out.

BATTERY HOLDER

The **batteries (B3)** produce an electrical **voltage** using a chemical reaction. This “voltage” can be thought of as electrical pressure, pushing electricity through a circuit just like a pump pushes water through pipes. This voltage is much lower and much safer than that used in your house wiring. Using more batteries increases the “pressure”, therefore, more electricity flows.



Battery Holder (B3)

MOTOR

The **motor (M1)** converts electricity into mechanical motion. An electric current in the motor will turn the shaft and the motor blades, and the fan blade if it is on the motor.



Motor (M1)

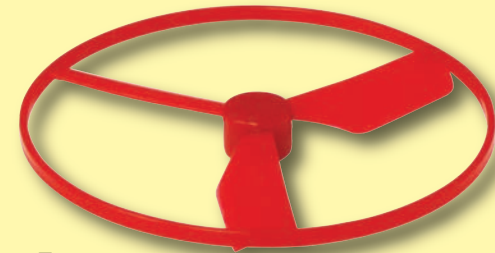

Fan

How does electricity turn the shaft in the motor? The answer is magnetism. Electricity is closely related to magnetism, and an electric current flowing in a wire has a magnetic field similar to that of a very, very tiny magnet. Inside the motor is a coil of wire with many loops wrapped around metal plates. This is called an electromagnet. If a large electric current flows through the loops, it will turn ordinary metal into a magnet. The motor shell also has a magnet on it. When electricity flows through the electromagnet, it repels from the magnet on the motor shell and the shaft spins. If the fan is on the motor shaft, then its blades will create airflow.

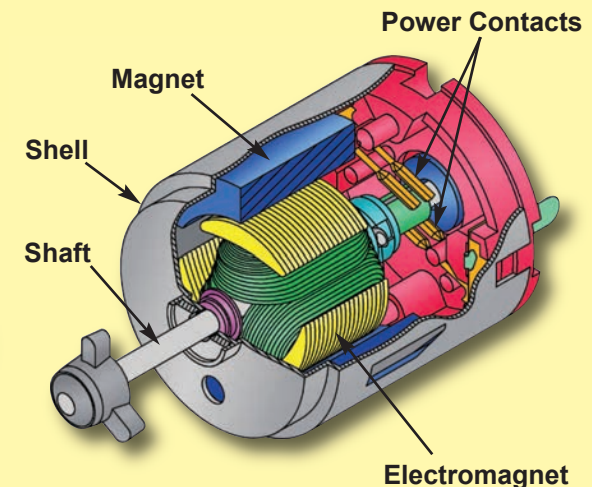

About Your Snap Circuits® XP Parts

RESISTORS

Resistors “resist” the flow of electricity and are used to control or limit the current in a circuit. Snap Circuits® XP includes **100Ω (R1)**, **1kΩ (R2)**, **10kΩ (R4)**, and **100kΩ (R5) resistors** (“K” symbolizes 1,000, so R4 is really 10,000Ω). Materials like metal have very low resistance (<1Ω), while materials like paper, plastic, and air have near-infinite resistance. Increasing circuit resistance reduces the flow of electricity.

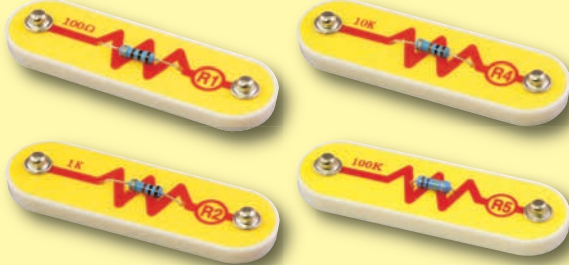

Resistors (R1, R2, R4, & R5)

The **adjustable resistor (RV)** is a 50kΩ resistor but with a center tap that can be adjusted between 200Ω and 50kΩ.



Adjustable Resistor (RV)

The **photoresistor (RP)** is a light-sensitive resistor, its value changes from nearly infinite in total darkness to about 1000Ω when a bright light shines on it.

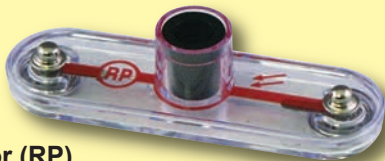

Photoresistor (RP)

SLIDE & PRESS SWITCHES

The **slide & press switches (S1 & S2)** connect (pressed or “ON”) or disconnect (not pressed or “OFF”) the wires in a circuit. When ON they have no effect on circuit performance. Switches turn on electricity just like a faucet turns on water from a pipe.



Slide & Press Switches (S1 & S2)

SPEAKER

The **speaker (SP)** converts electricity into sound by making mechanical vibrations. These vibrations create variations in air pressure, which travel across the room. You “hear” sound when your ears feel these air pressure variations.



Speaker (SP)

MICROPHONE

The **microphone (X1)** is actually a resistor that changes in value when changes in air pressure (sounds) apply pressure to its surface. Its resistance typically varies from around 1kΩ in silence to around 10kΩ when you blow on it

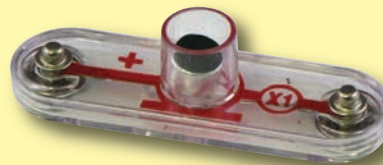

Microphone (X1)

RED & GREEN LED's

The **red & green LED's (D1 & D2)** are light emitting diodes, and may be thought of as a special one-way light bulb. In the “forward” direction, (indicated by the “arrow” in the symbol) electricity flows if the voltage exceeds a turn-on threshold (about 1.5V for red and a little higher for green); brightness then increases. A high current will burn out the LED, so the current must be limited by other components in the circuit. LED's block electricity in the “reverse” direction.



LED's (D1 & D2)

CAPACITOR

The **470μF capacitor (C5)** can store electrical pressure (voltage) for periods of time. This storage ability allows it to block stable voltage signals and pass changing ones. Capacitors are used for filtering and delay circuits.

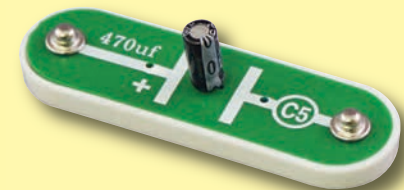

Capacitor (C5)

About Your Snap Circuits® XP™ Parts

TRANSISTORS

The **NPN (Q2) transistors** are components that use a small electric current to control a large current, and are used in switching, amplifier, and buffering applications. They are easy to miniaturize, and are the main building blocks of integrated circuits including the microprocessor and memory circuits in computers.



NPN Transistor (Q2)

MICROCONTROLLER

The microcontroller IC (U21) includes the PICAXE® 08M2 integrated circuit. This is a mini computer which can be programmed to perform different tasks, including monitoring things and making things happen. The PICAXE® 08M2 has a special programming interface that makes it very easy to use.



Microcontroller IC (U21)

Microcontroller outputs cannot control the motor or speaker directly, an interface transistor must be used. Microcontroller outputs can control Snap Circuits® LEDs directly.

Note: There is additional information for the PICAXE® 08M2 integrated circuit at www.picaxe.co.uk.

U21 Microcontroller IC:

- (+) - power from batteries
- (GND) - power return to batteries
- S-In - Programming input snap
- S-Out / Snap 0 - Serial Output 0
- Snap 1 - IN1/OUT1/ADC1
- Snap 2 - IN2/OUT2/ADC2
- Snap 3 - IN3
- Snap 4 - IN4/OUT4/ADC4

Notes for using the PICAXE®-08M2 in other applications:

Power source:

This should be 4.5V or 5V. Higher voltages may damage the part.

S-In connection:

The U21 platform has an internal 10KΩ resistor between the S-In and GND snaps, and a 22KΩ resistor between the S-In snap and the microcontroller. These facilitate use of the programming cable.

Several snaps can be used as either inputs, outputs, or analog to digital converters:

as Outputs: Each output can supply or receive up to 20 mA. This is enough to light an LED, but an interface transistor must be used when controlling a motor or speaker.

as Inputs: An input should be above 80% of the power source voltage to be high, or below 20% of the power source voltage to be low.

as Analog to Digital Converters (ADC): The ADC range is the power source voltage range. Circuit resistance should be less than 20KΩ, or false readings may occur.

CABLES

The **programming cable** is used to program and communicate with the U21 microcontroller.



Programming Cable

Introduction to Electricity

What is electricity? Nobody really knows. We only know how to produce it, understand its properties, and how to control it. Electricity is the movement of sub-atomic charged particles (called **electrons**) through a material due to electrical pressure across the material, such as from a battery.

Power sources, such as batteries, push electricity through a circuit, like a pump pushes water through pipes. Wires carry electricity, like pipes carry water. Devices like LEDs, motors, and speakers use the energy in electricity to do things. Switches and transistors control the flow of electricity like valves and faucets control water. Resistors limit the flow of electricity.

The electrical pressure exerted by a battery or other power source is called **voltage** and is measured in **volts** (V). Notice the “+” and “-” signs on the battery; these indicate which direction the battery will “pump” the electricity.

The **electric current** is a measure of how fast electricity is flowing in a wire, just as the water current describes how fast water is flowing in a pipe. It is expressed in **amperes** (A) or **milliamperes** (mA, 1/1000 of an ampere).

The **“power”** of electricity is a measure of how fast energy is moving through a wire. It is a combination of the voltage and current (Power = Voltage x Current). It is expressed in **watts** (W).

The **resistance** of a component or circuit represents how much it resists the electrical pressure (voltage) and limits the flow of electric current. The relationship is Voltage = Current x Resistance. When the resistance increases, less current flows. Resistance is measured in **ohms** (Ω), or **kilo ohms** (k Ω , 1000 ohms).

Nearly all of the electricity used in our world is produced at enormous generators driven by steam or water pressure. Wires are used to efficiently transport this energy to homes and businesses where it is used. Motors convert the electricity back into mechanical form to drive machinery and appliances. The most important aspect of electricity in our society is that it allows energy to be easily transported over distances.

Note that “distances” includes not just large distances but also tiny distances. Try to imagine a plumbing structure of the same complexity as the circuitry inside a portable radio - it would have to be large because we can’t make water pipes so small. Electricity allows complex designs to be made very small.

There are two ways of arranging parts in a circuit, in series or in parallel. Here are examples:

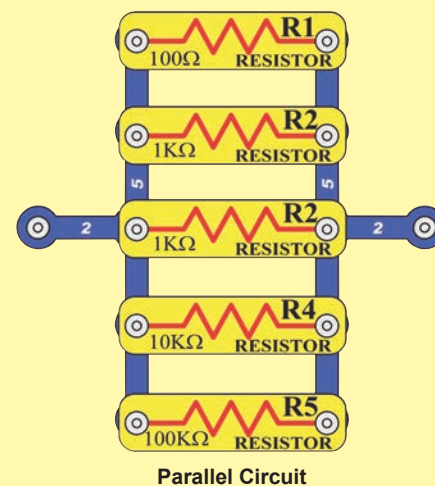
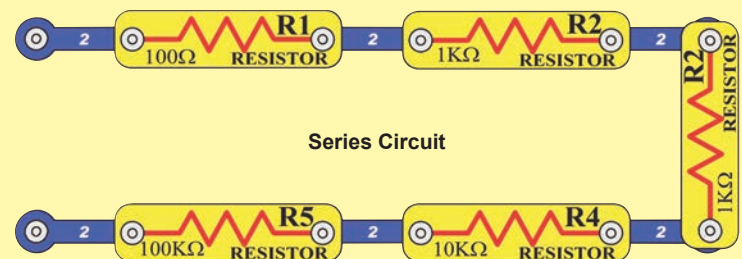

Placing components in series increases the resistance; highest value dominates. Placing components in parallel decreases the resistance; lower value dominates.

The parts within these series and parallel sub-circuits may be arranged in different ways without changing what the circuit does. Large circuits are made of combinations of smaller series and parallel circuits.

DO's and DON'Ts of Building Circuits

After building the circuits given in this booklet, you may wish to experiment on your own. Use the projects in this booklet as a guide, as many important design concepts are introduced throughout them. Every circuit will include a power source (the batteries), a resistance (which might be a resistor, capacitor, motor, integrated circuit, etc.), and wiring paths between them and back. **You must be careful not to create "short circuits"** (very low-resistance paths across the batteries, see examples at right) as this will **damage components and/or quickly drain your batteries**. Only connect the U21 microcontroller IC (the PICAXE 08M) using configurations given in the projects, incorrectly doing so may damage it. **ELENCO® is not responsible for parts damaged due to incorrect wiring.**

Here are some important guidelines:

- ALWAYS** USE EYE PROTECTION WHEN EXPERIMENTING ON YOUR OWN.
- ALWAYS** include at least one component that will limit the current through a circuit, such as the speaker, capacitors, ICs (which must be connected properly), motor, microphone, photoresistor, or resistors.
- ALWAYS** use LEDs, transistors, and switches in conjunction with other components that will limit the current through them. Failure to do so will create a short circuit and/or damage those parts.
- ALWAYS** connect capacitors so that the "+" side gets the higher voltage.
- ALWAYS** disconnect your batteries immediately and check your wiring if something appears to be getting hot.
- ALWAYS** check your wiring before turning on a circuit.
- ALWAYS** connect U21 microcontroller IC using configurations given in the projects or as per the connection description on page 5.
- NEVER** connect to an electrical outlet in your home in any way.
- NEVER** touch the motor when it is spinning at high speed.



Warning to Snap Circuits® owners: Do not use parts from other Snap Circuits® sets with this kit. Other sets use higher voltage which could damage the microcontroller and other parts.

You are encouraged to tell us about new programs and circuits you create. If they are unique, we will post them with your name and state on our website at www.snapcircuits.net/kidkcreations.htm. Send your suggestions to ELENCO®: elenco@elenco.com.

ELENCO® provides a circuit designer so that you can make your own Snap Circuits® drawings. This Microsoft® Word document can be downloaded from www.snapcircuits.net/SnapDesigner.doc or through the www.snapcircuits.net website.

Examples of SHORT CIRCUITS - NEVER DO THESE!!!

Placing a 3-snap wire directly across the batteries is a SHORT CIRCUIT.



NEVER DO!

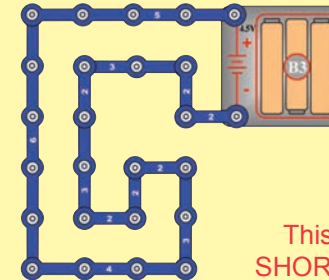
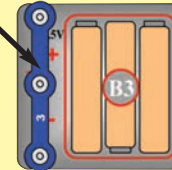

NEVER DO!

This is also a SHORT CIRCUIT.

When the slide switch (S1) is turned on, this large circuit has a SHORT CIRCUIT path (as shown by the arrows). The short circuit prevents any other portions of the circuit from ever working.

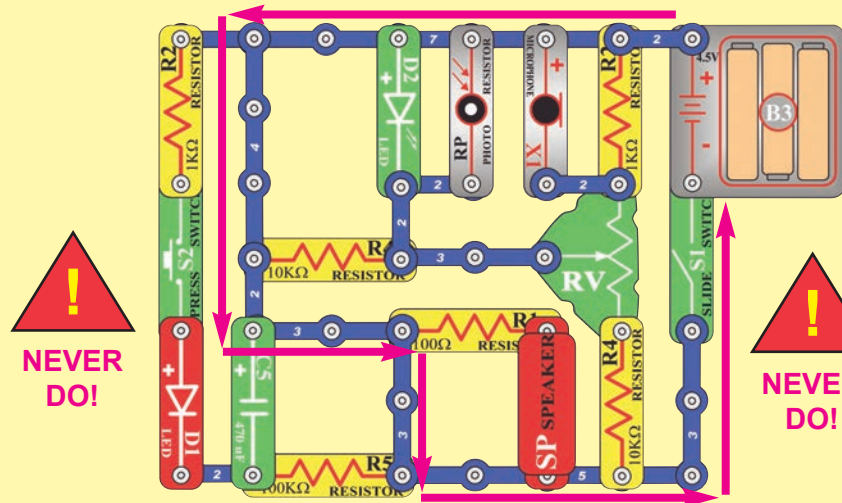

NEVER DO!



NEVER DO!



WARNING: SHOCK HAZARD - Never connect Snap Circuits® to the electrical outlets in your home in any way!

Advanced Troubleshooting (Adult supervision recommended)

ELENCO® is not responsible for parts damaged due to incorrect wiring.

If you suspect you have damaged parts, you can follow this procedure to systematically determine which ones need replacing:

(Note: Some of these tests connect an LED directly across the batteries without another component to limit the current. Normally this might damage the LED, however Snap Circuits® LEDs have internal resistors added to protect them incorrect wiring, and will not be damaged.)

1. **LEDs (D1 & D2), motor (M1), speaker (SP), and battery holder (B3):** Place batteries in holder. Place one of the LEDs directly across the battery holder (LED + to battery +), it should light. Do the same for the motor, it should spin. "Tap" the speaker across the battery holder contacts, you should hear static as it touches. If none work, then replace your batteries and repeat. If still bad, then the battery holder is damaged.

2. **Jumper wires:**

Use this mini-circuit to test each jumper wire, the LED should light.

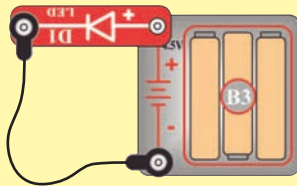

3. **Snap wires:** Use this mini-circuit to test each of the snap wires, one at a time. The LED should light.

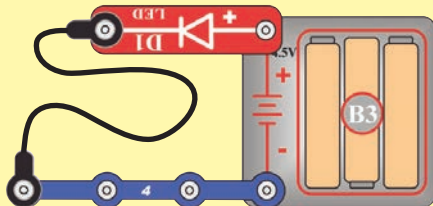

4. **Slide switch (S1) and Press switch (S2):**

Use this mini-circuit; if the LED doesn't light then the slide switch is bad. Replace the slide switch with the press switch to test it.

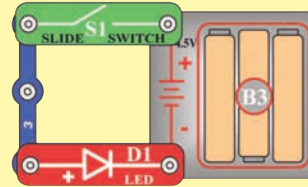

5. **100Ω (R1), 1kΩ (R2), and 10kΩ (R4) resistors:**

Use the mini-circuit from test 4 but replace the switch with the 100Ω resistor (R1); the LED will be bright if the resistor is good. Next use the 1kΩ and 10kΩ resistors in place of the 100Ω resistor; the LED should be dimmer but still light.

6. **Microphone (X1) and Photoresistor (RP):**

Use the mini-circuit from test 4 but replace the switch with the microphone (X1, + on right); if blowing into the microphone does not change the LED brightness then the microphone is bad. Replace the microphone with the photoresistor. Waving your hand over the photoresistor (changing the light that shines on it) should change the brightness of the LED or the photoresistor is bad.

7. **Adjustable resistor (RV):** Build Project #A16, the resistor control lever should turn the LED (D1) on and off; otherwise it is bad.

8. **NPN transistor (Q2):** Build the mini-circuit shown here. The LED (D2) should only be on if the press switch (S2) is pressed. If otherwise, then the NPN is damaged.

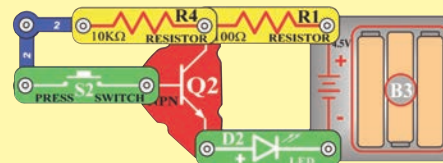

9. **470μF capacitor (C5) and 100kΩ resistor (R5):**

Build the mini-circuit shown here. When you press the switch, the LED should be bright but then slowly get dim, otherwise the capacitor is bad. Replace the 1kΩ resistor (R2) with the 100kΩ resistor (R5); the LED should stay on much longer or R5 is bad.

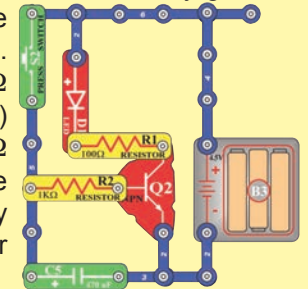

10. **Programming cable:** Connect the cable to the red LED (D1), orange and yellow wires to (+) and black wire to the other side. Run the AXEpad for Snap Circuits® XP software. Open a terminal (press F8). Type something into the output buffer and press Send. The red LED should flash and what you typed should appear in the input buffer.



11. **Microcontroller (U21):** Use project B27 (Test the Microcontroller).

ELENCO®

150 Carpenter Avenue
Wheeling, IL 60090 U.S.A.
Phone: (847) 541-3800
Fax: (847) 520-0085
e-mail: help@elenco.com
Website: www.elenco.com

You may order additional /
replacement parts at:
www.snapcircuits.net

Project Listings

Part A - Introductory Projects: These projects introduce you to the Snap Circuits® method of building circuits and show how electronic components work. No computer is needed for these projects (some projects use the U21 microcontroller, but with a factory-loaded program).

Part B - Microcontroller Projects: These projects are an introduction to microprocessors, and the flexibility they give by being

programmable. A computer is needed to load programs into the microcontroller, but no other programming knowledge is needed. The microcontroller re-programming procedure is explained in project B1.

Part C - To Go Further: This section is intended for users who would like to develop their own programs for the microcontroller. It also has bonus circuits for owners of other Snap Circuits® models.

Project #	Title	Page #	Project #	Title	Page #
A1	Electric Light	11	A30	One Shot	27
A2	Controlling Electricity	11	B1	Blinker (Programming the Microcontroller)	29
A3	Dancing Motor	12	B2	Blinkers	33
A4	Electronic Counter	13	B3	Four Outputs	34
A5	Adding Sound to the Counter	14	B4	Play a Tune	35
A6	Daylight Alarm Clock	14	B5	Computer Music Box	36
A7	Intruder Alarm	15	B6	Random Sounds	38
A8	Jukebox	16	B7	Sloppy Switches	39
A9	Counting to the Stars	17	B8	Bounceless Switches	40
A10	Angles and Distance	18	B9	Jukebox with Terminal	41
A11	Flip-Flop	19	B10	Launch Pad	42
A12	Adjustable Light Timer	19	B11	Adjustable Blinker	43
A13	Light Sensitive Timer	20	B12	Basic Light Meter	44
A14	Shot in the Dark	20	B13	Capacitor Discharge	45
A15	Microphone Control	21	B14	Sunrise Alarm	46
A16	Adjustable Brightness	21	B15	Photon Counter	47
A17	Conduction Detector	21	B16	Photon Kazoo	47
A18	Slider	22	B17	Click Counter	48
A19	Parallel Resistors	22	B18	Super Click Counter	49
A20	Series Resistors	22	B19	Data Logger	50
A21	Flying Saucer	23	B20	Data Logger with Cost	51
A22	Transistor	23	B21	24 Hour Data Logger	52
A23	Capacitor Battery	24	B22	Digital Voltmeter	53
A24	Blow Off Sound	24	B23	Battery Tester (4V or less)	54
A25	Capacitor Photo Control	25	B24	Battery Tester (20V or less)	55
A26	Capacitor Photo Control with Slow Shut-off	25	B25	Clap Light	56
A27	Photo Switcher	26	B26	Clap Music	57
A28	Blow On Sound	26	B27	Test the Microcontroller	58
A29	Scratchy Amplifier	27			

PART A - Introductory Projects

How to Use Snap Circuits®

Snap Circuits® uses building blocks with snaps to build the different electrical and electronic circuits in the projects. Each block has a function: there are switch blocks, light blocks, battery blocks, different length wire blocks, etc. These blocks are different colors and have numbers on them so that you can easily identify them. The blocks you will be using are shown as color symbols with level numbers next to them, allowing you to easily snap them together to form a circuit.

For Example:

This is the switch block which is green and has the marking **S2** on it. The part symbols in this booklet may not exactly match the appearance of the actual parts, but will clearly identify them.



This is a wire block which is blue and comes in different wire lengths.

This one has the number **2**, **3**, **4**, **5**, **6**, or **7** on it depending on the length of the wire connection required.



There is also a 1-snap wire that is used as a spacer or for interconnection between different layers.



You need a power source to build each circuit. This is labeled **B3** and requires three (3) "AA" batteries (not included).



A large clear plastic base grid is included with this kit to help keep the circuit blocks properly spaced. You will see evenly spaced posts that the different blocks snap into. The base has rows labeled A-G and columns labeled 1-10. Next to each part in every circuit drawing is a small number in black. This tells you which

level the component is placed at. Place all parts on level 1 first, then all of the parts on level 2, then all of the parts on level 3, etc. Some circuits use the jumper wires to make unusual connections. Just clip them to the metal snaps or as indicated.



Usually when the motor **M1** is used, the fan will be placed on it.

No computer is needed for introductory projects (some projects use the U21 microcontroller, but with a factory-loaded program).

Occasionally you may feel static electricity if you touch a circuit when the programming cable is connected, usually when humidity is very low. Don't worry; this is harmless. It occurs because the cable makes an easy electrical path between your body and the ground, allowing static that has built up on you to dissipate. Sometimes this static electricity may reset the microcontroller (U21), causing it to re-start its program.

Note: While building the projects, be careful not to accidentally make a direct connection across the battery holder (a "short circuit"), as this may damage and/or quickly drain the batteries.



Project A1

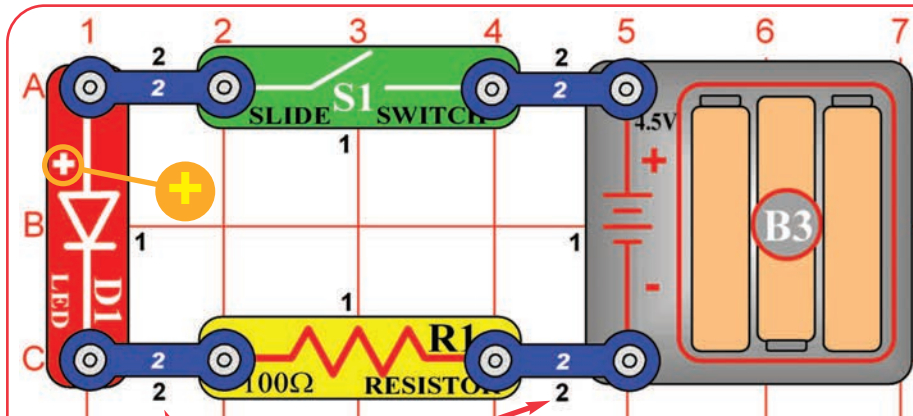

Placement Level Numbers

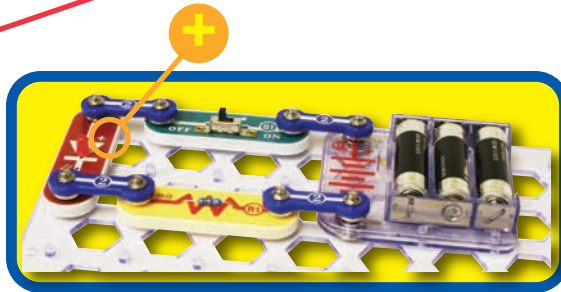

Electric Light

Snap Circuits® uses electronic blocks that snap onto a clear plastic grid to build different circuits. These blocks have different colors and numbers on them so that you can easily identify them.

Build the circuit shown on the left by placing all the parts with a black 1 next to them on the board first. Then, assemble parts marked with a 2. Install three (3) “AA” batteries (not included) into the battery holder (B3) if you have not done so already.

When you turn on the slide switch (S1), current flows from the batteries through the switch, red LED (D1), and 100Ω resistor (R1), and back to the batteries. Turning on the switch completes the circuit. When the switch is off, the current can no longer flow back to the battery, so the red LED goes out.

The red LED is just like the ones used in electronic products throughout your home.



Project A2



Use the circuit built in project A1, but replace the 100Ω resistor (R1) with the 1kΩ resistor (R2). The circuit works the same, but the red LED (D1) will not be as bright.

Now replace the 1kΩ resistor with the 10kΩ resistor (R4). The LED will be dim now.

Now replace the 10kΩ resistor (R4) with the 100kΩ resistor (R5). The 100kΩ has very high resistance, so you may not see any light from the LED.

Take the circuit into a really dark room or curl your fingers around the LED to block the surrounding light. Now you see that the LED is on, though very dim.

Controlling Electricity

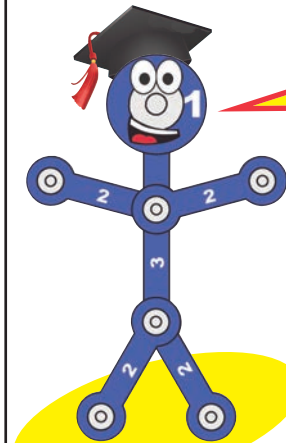

Snappy says resistors are used to control or limit the flow of electricity in a circuit. Higher resistor values reduce the flow of electricity in a circuit.

In this circuit, the resistors are used to adjust the LED brightness, to limit the current so the batteries last longer, and to protect the LED from being damaged by the batteries.

What is Resistance? Take your hands and rub them together very fast. Your hands should feel warm. The friction between your hands converts your effort into heat. Resistance is the electrical friction between an electric current and the material it is flowing through.



Project A3

Dancing Motor

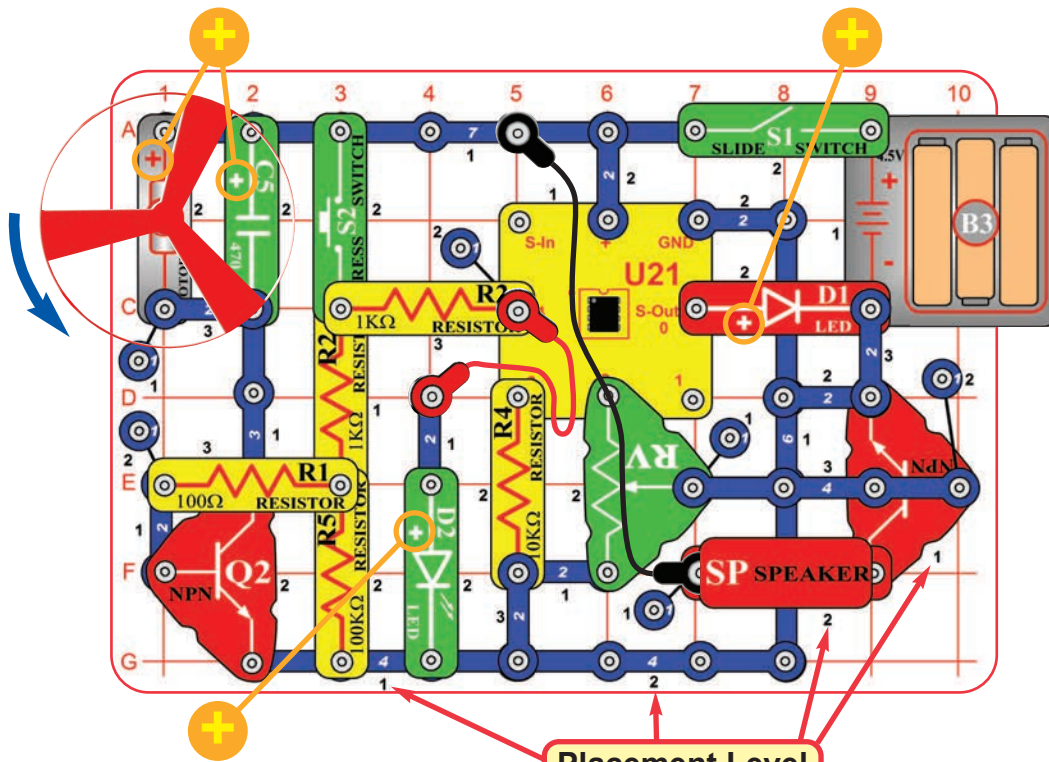

WARNING: Moving parts. Do not touch the fan or motor during operation. Do not lean over the motor.

Placement Level Numbers

This complex circuit is pictured on the front cover, use that as a guide to help build it.

The program in the microcontroller IC (U21) controls power to the motor (M1), flashes the LED (D2), and sends music to the speaker (SP). The microcontroller is like an electronic brain running the circuit.

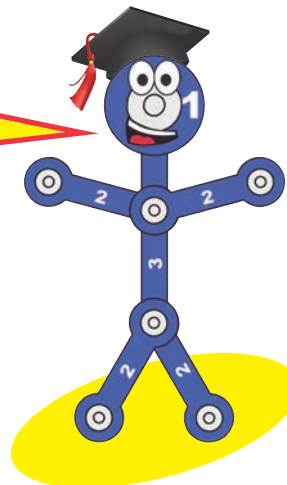

Note: This circuit requires program Electronic Brain to be in microcontroller U21's memory. This is loaded into U21 at the Snap Circuits® factory and should still be there, unless you already reprogrammed it. If it has been reprogrammed, you must use project B1 (on page 29) to load program Electronic Brain back into U21 before building this circuit.

Snap Circuits® uses electronic blocks that snap onto a clear plastic grid to build different circuits. These blocks have different colors and numbers on them so that you can easily identify them.

Build the circuit shown above by placing all the parts with a black 1 next to them on the board first. Then, assemble parts marked with a 2. Then, assemble parts marked with a 3. Install three (3) "AA" batteries (not included) into the battery holder (B3) if you have not done so already.

Turn on slide switch (S1) and wait for the red LED (D1) to come on. Push the press switch (S2) and hold it down until music starts. Set the lever on the adjustable resistor (RV) for best sound. The motor (M1) will spin while you push S2, and then will follow the music as it plays. The red & green LEDs (D1 & D2) will blink in time with the music. The fan blade is not necessary and may be removed.

To change the song, push and release S2, then push it again but hold it down until music starts. For more songs, turn S1 off and on, slowly push and release S2 four times, then push and hold down S2 until music starts.

If you flip the motor around then the fan will rise into the air like a flying saucer.



Project A4

Electronic Counter

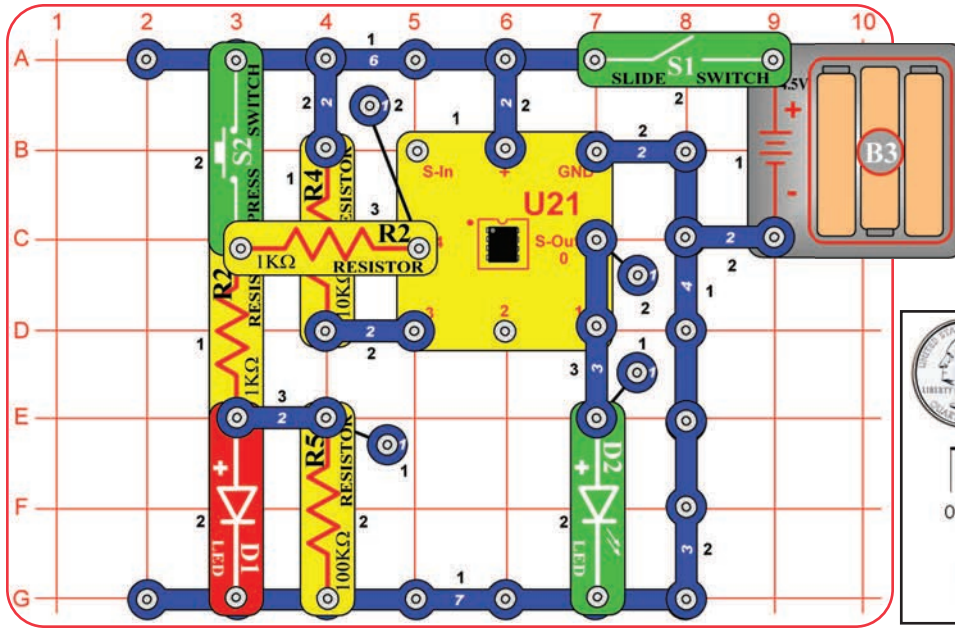

We measure many things in quarters. This picture shows only a few of them. How many more can you think of that uses a system like this?

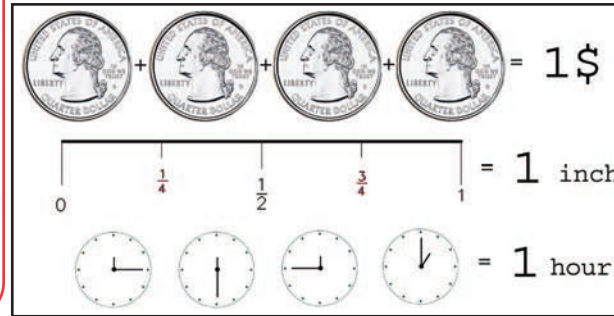
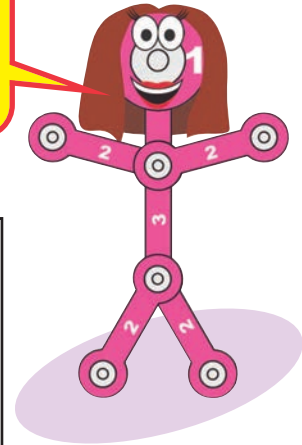

Note: This circuit requires program Electronic Brain to be in microcontroller U21's memory. This is loaded into U21 at the Snap Circuits® factory and should still be there, unless you already reprogrammed it. If it has been reprogrammed, you must use project B1 (on page 29) to load program Electronic Brain back into U21 before building this circuit.

The circuit will count how many times you press switch S2, then announce the answer by flashing LEDs.

Turn on slide switch (S1) and wait a moment for the green LED (D2) to come on. Slowly press

switch S2 up to 255 times; the red LED (D1) flashes each time. Then wait 10 seconds.

After 10 seconds, the microcontroller (U21) recognizes that it is time to display the count. The green LED will turn off, and then the green & red LEDs will flash based on the number of S2 presses. The green LED will flash first and each flash counts as 4, then the red LED will flash and each flash counts as 1.

For example, if you pressed S2 14 times, the green LED will flash 3 times (representing 12, since each counts as 4) and the

red LED will flash 2 times ($12 + 2 = 14$).

When the microcontroller finishes displaying the count, the green LED will stay on, indicating the microcontroller is ready for you to press S2 more.

The total is cumulative, and so includes earlier presses in counting mode. Turn slide switch S1 off and on to reset the count to zero.

When pressing S2 to count, do not press it rapidly on and off, or the microcontroller may miss counts. The red LED should blink after each count.

Part B: 64 second timer

Turn slide switch S1 off and on to reset the circuit, and wait for the green LED to come on. Push press switch S2 and hold it down until the green LED turns off. After a short pause, the red LED will come on and stay on for about 64 seconds.



Project A5

Adding Sound to the Counter

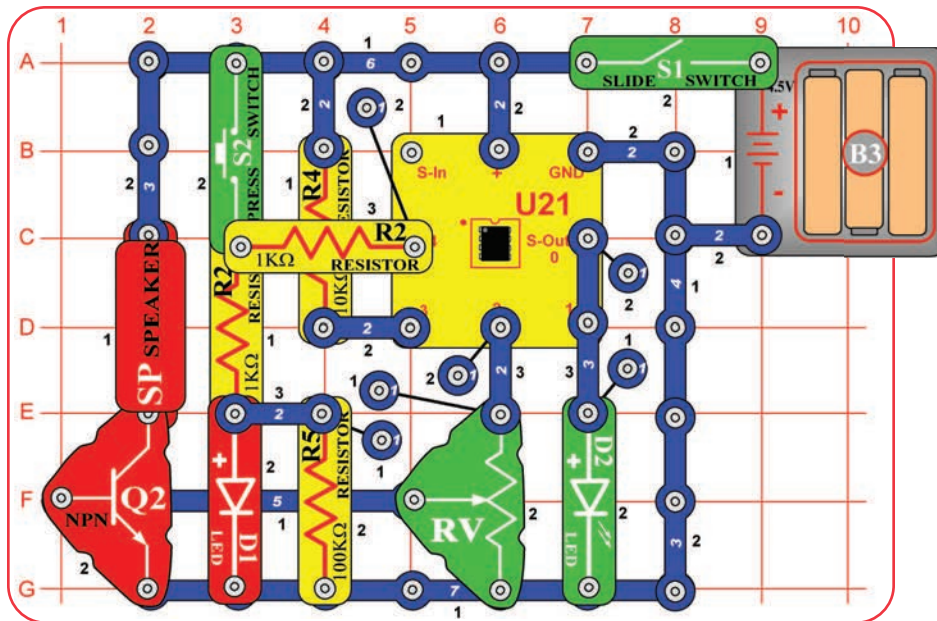

Note: This circuit requires program Electronic Brain to be in microcontroller U21's memory. This is loaded into U21 at the Snap Circuits® factory and should still be there, unless you already reprogrammed it. If it has been reprogrammed, you must use project B1 to load program Electronic Brain back into U21 before building this circuit.

Turn off the slide switch (S1). Use the circuit from the preceding project, but add parts to it so it matches the one shown here. Set the lever on the adjustable resistor (RV) to the middle.

Turn on the slide switch (S1), and wait a moment for the green LED (D2) to come on. Slowly press the press switch (S2) six times, then press it again but hold it down until music starts. The red & green LEDs blink in time as a song plays. You can adjust the sound volume using the lever on the adjustable resistor. The green LED will stay on when the song is finished.

The microcontroller can produce other tunes. Push the press switch several times (not six times), and then hold it down until an alarm plays. The green LED will come on when the alarm is finished.

You can still use the circuit as a counter like in the preceding project. To count, press switch S2 several times then wait 10 seconds (don't hold S2 down). The LEDs will display the count as before, without music.



Project A6

Daylight Alarm Clock

Use the preceding circuit, but replace the press switch (S2) with the photoresistor (RP). Place the circuit in a dark room and turn on the slide switch (S1). The green LED (D2) will come on, indicating the circuit is working.

When a room light is turned on for more than 10 seconds, or sunlight makes the room bright, an alarm will sound. The warning will repeat approximately every minute until the slide switch is turned off or the room is made dark again.

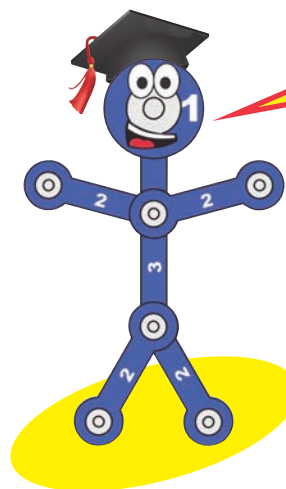

In darkness, the photoresistor has high resistance, like a switch that is turned off. When light shines on it, the photoresistor has much lower resistance, like a switch that is turned on.

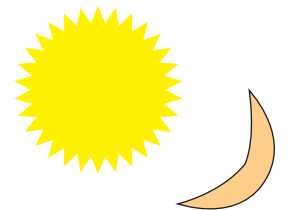



Project A7

Intruder Alarm

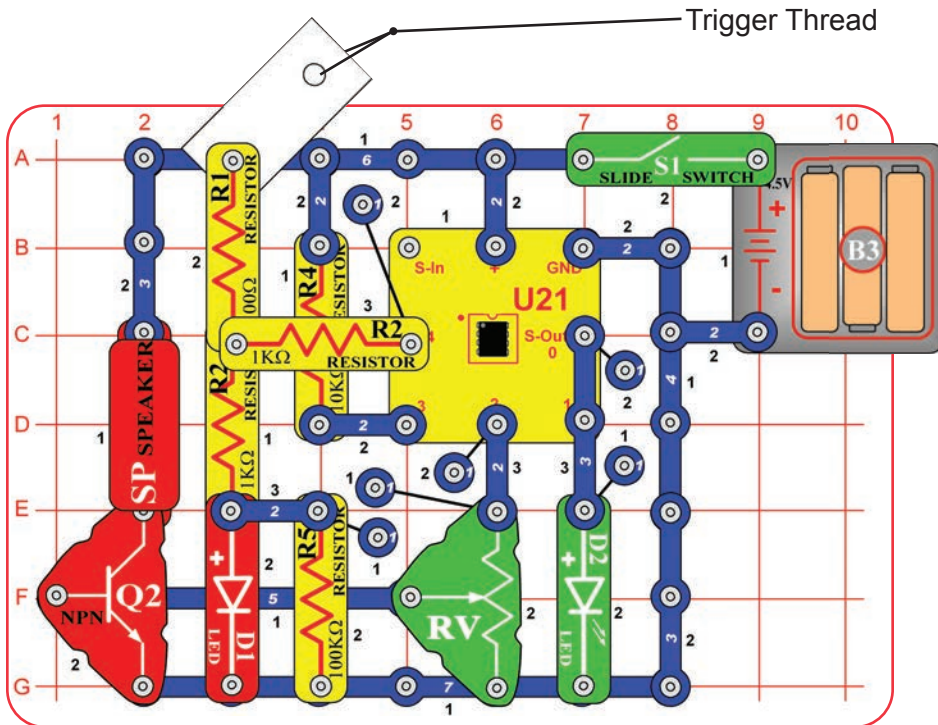

Use the circuit from project A5, but replace the press switch (S2) with the 100Ω resistor (R1). Place a business card or old playing card under one end of the 100Ω resistor, as shown.

Tie a fine black trigger thread on the card and the other end of the thread to a fixed object in the room. Make sure the trigger thread stretches across a walk path or in front of a door that will catch the trigger thread when opened. Turn on the slide switch (S1). The green LED will come on indicating the alarm is active.

When an intruder trips on the trigger thread, the red light will come on for a few seconds and then the alarm will sound. The warning will repeat every minute until the slide switch is turned off or the card is placed back under the 100Ω resistor. You can adjust the sound volume using the lever on the adjustable resistor (RV).

Note: After the circuit has been on for several minutes without being triggered by an intruder, the green LED will turn off. Don't worry, your alarm circuit is still working. The software running the microcontroller (U21) has a shutdown feature, which preserves battery life when there isn't much happening. The microcontroller is sleeping, but it will wake up if an intruder triggers the alarm. Turn off the slide switch (S1) to turn off the circuit completely.

The green LED uses about 20mA of electricity when it is lit. This isn't much, but it will drain the batteries after several days when it is left on for 24 hours a day. Battery-preserving shutdown modes are an important feature of microcontrollers.

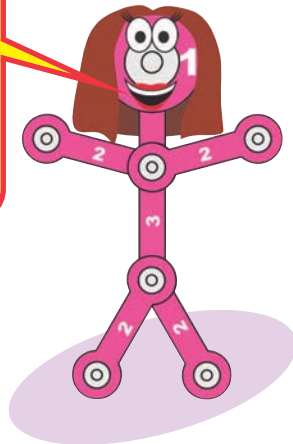

Note: This circuit requires program Electronic Brain to be in microcontroller U21's memory. This is loaded into U21 at the Snap Circuits® factory and should still be there, unless you already reprogrammed it. If it has been reprogrammed, you must use project B1 to load program Electronic Brain back into U21 before building this circuit.



Project A8

Jukebox

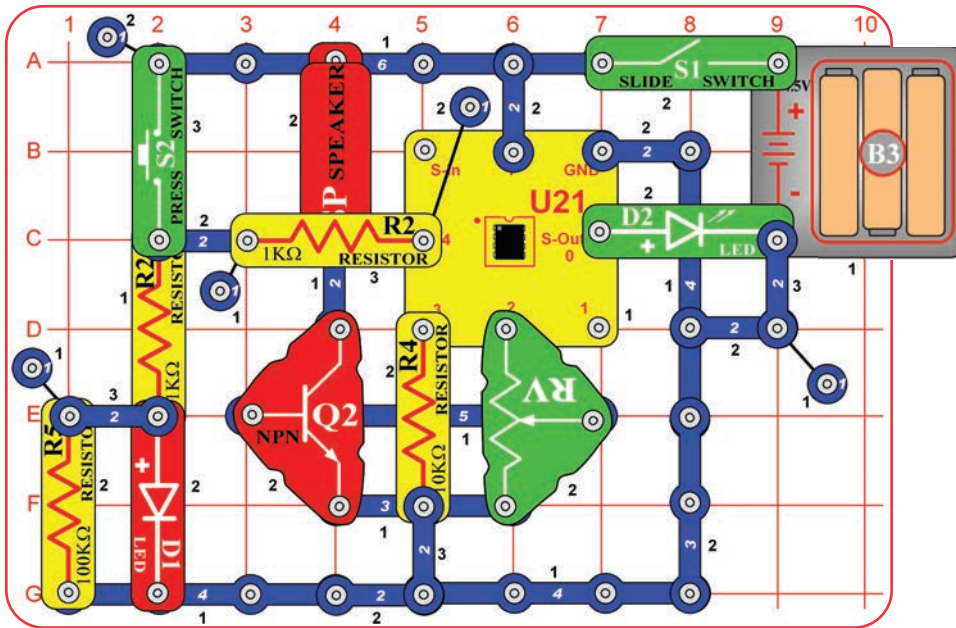

Note: This circuit requires program Electronic Brain to be in microcontroller U21's memory. This is loaded into U21 at the Snap Circuits® factory and should still be there, unless you already reprogrammed it. If it has been reprogrammed, you must use project B1 to load program Electronic Brain back into U21 before building this circuit.

Set the lever on the adjustable resistor (RV) to the middle. Turn on the slide switch (S1), and wait a moment for the green LED (D2) to come on. Push the press switch (S2) and hold it down until music starts. The red & green LEDs blink in time as a song plays. You can adjust the sound volume using the lever on the adjustable resistor. The green LED will stay on when the song is finished.

The microcontroller (U21) contains four songs that are built into memory and cannot be erased. Each of these can be programmed to play and flash lights. The machines that play songs on command are called "jukeboxes". A jukebox is a partially automated music-playing device, usually a coin-operated machine, that can play specially selected songs from self-contained media. You just made a simple jukebox!

Select a song to play when the green LED is on and not flashing. S2 presses are cumulative, unless you turn the slide switch on and off between songs.

- 1) Press and hold down S2 to play "Birthday Song".
- 2) Press S2 once, then press it again and hold it down for "Jingle Bells".
- 3) Press S2 twice, then press it again and hold it down for "Silent Night".
- 4) Press S2 three times, then press it again and hold it down for "Rudolph the Red Nose Reindeer".
- 5) Press S2 four times, then press it again and hold it down for all of the above songs in reverse order.
- 6) Press S2 five or more times, then press it again and hold it down to play another familiar song.





Project A9

Counting To The Stars

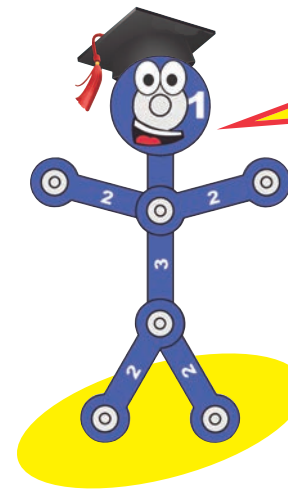
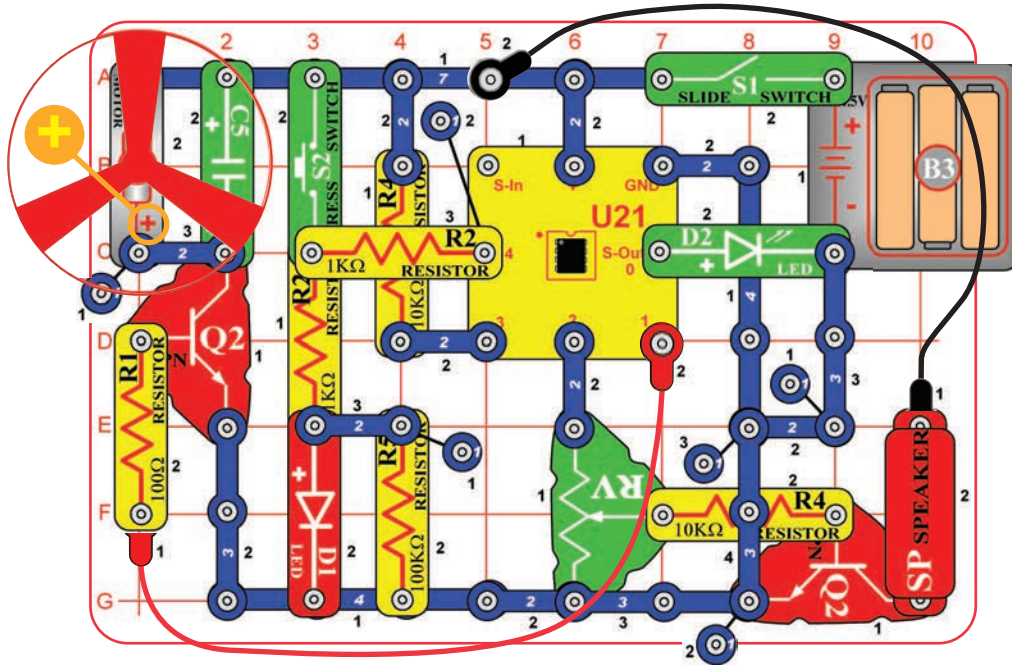

This complex circuit is pictured on the box cover, use that as a guide to help build it.

The program in the microcontroller IC (U21) controls power to the motor (M1), flashes the LEDs (D1 & D2), and sends music to the speaker (SP).

The microcontroller is like an electronic brain running the circuit.

WARNING: Moving parts. Do not touch the fan or motor during operation. Do not lean over the motor.

Note: This circuit requires program Electronic Brain to be in microcontroller U21's memory. This is loaded into U21 at the Snap Circuits® factory and should still be there, unless you already reprogrammed it. If it has been reprogrammed, you must use project B1 to load program Electronic Brain back into U21 before building this circuit.

The circuit will count how many times you press switch S2, play some music, and then spin the fan for a duration based on how many times you pressed the switch.

Part A. Turn on slide switch (S1) and wait a moment for the green LED (D2) to come on. Press switch S2 once; the red LED (D1) flashes. Wait for the green LED (D2) to turn off

(about 10 seconds after you press S2). When the green LED comes back on, press and hold down S2 until music starts. The motor (M1) will spin for 1/4 second and stop. The green LED will come back on, indicating the time has been reset.

Part B. Now press switch S2 three times, and wait for the green LED to go off. The red LED will flash three times, indicating the motor will spin for 3/4 seconds. Press and hold down switch S2 until the music starts. The motor should spin for 3/4 seconds, and the fan may rise into the air.

Part C. Now press switch S2 ten times, and wait for the green LED to go off. The green LED will flash twice and the red LED will flash

twice. Each green flash equals 1 second and each red flash equals 1/4 second, so the motor should spin for 2 and 1/2 seconds. Press and hold down switch S2 until the music starts. The motor should spin for 2 and 1/2 seconds, and the fan will rise into the air.

Part D. For each time you push the switch, the motor will spin for 1/4 second. Press switch S2 up to fifty times, and wait for the green LED to go off. The green & red LEDs will flash based on the motor spin time you entered; each green flash equals 1 second and each red flash equals 1/4 second. Press and hold down switch S2 until the music starts. The motor should spin for the duration you entered; if the time is long enough then the fan will rise into the air.



Project A10

Angles and Distance

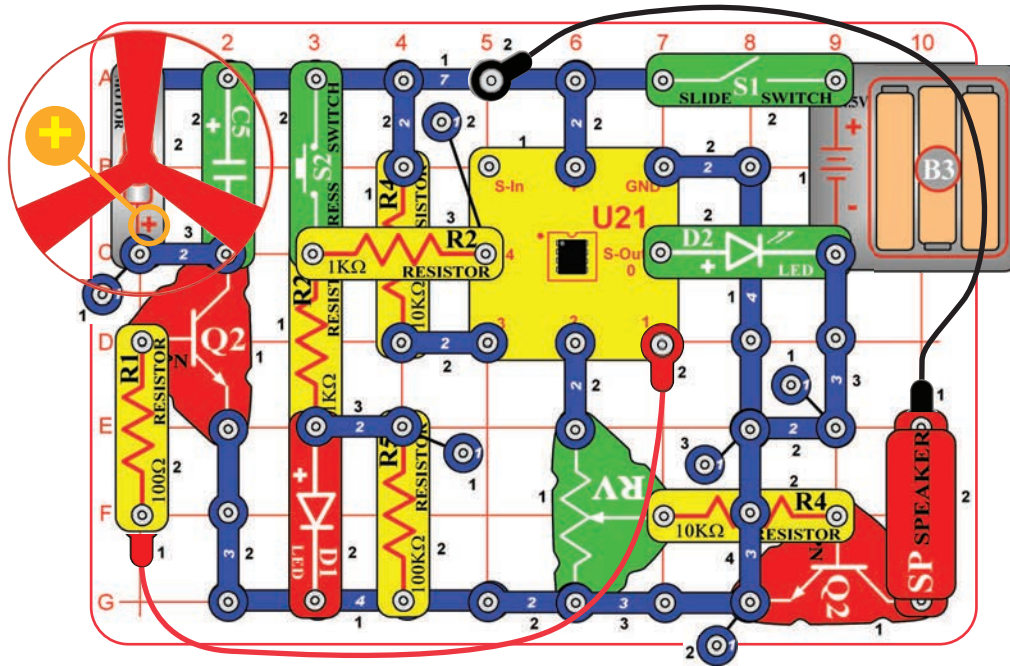

Note: This circuit requires program Electronic Brain to be in microcontroller U21's memory. This is loaded into U21 at the Snap Circuits® factory and should still be there, unless you already reprogrammed it. If it has been reprogrammed, you must use project B1 to load program Electronic Brain back into U21 before building this circuit.

Use the same circuit as project A9, but place a book or other object under the base to create a launch angle as shown. Place a piece of paper or short box on the floor approximately three feet in front of the snap circuit base. This paper/box is the target area landing zone.

Turn on slide switch (S1) and wait a moment for the green LED (D2) to come on. Push the press switch (S2) as many times as desired, then press it again and hold it down. When an alarm starts, release S2. When the alarm stops, the motor (M1) should spin for a while, and then the fan should launch toward the target. Repeat, pressing S2 more or less times. The more times you press S2, the higher/farther the fan should fly. See who can land the fan on the paper/box with the fewest launches.

WARNING: Moving parts. Do not touch the fan or motor during operation. Do not lean over the motor.

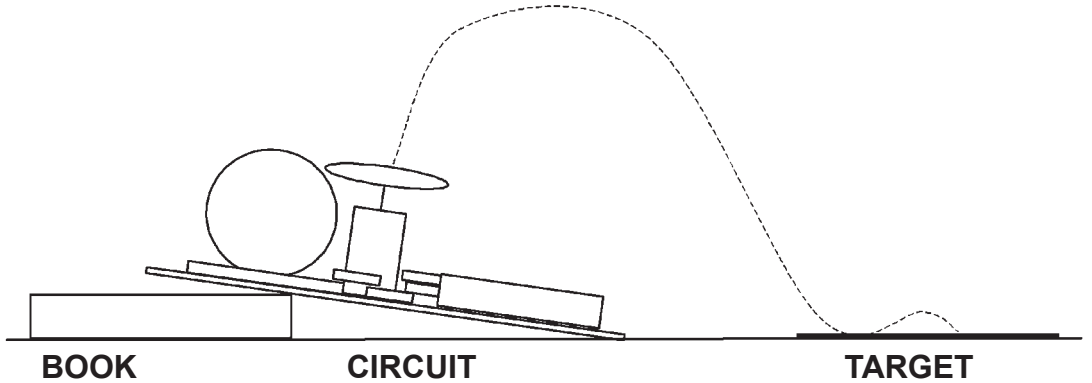
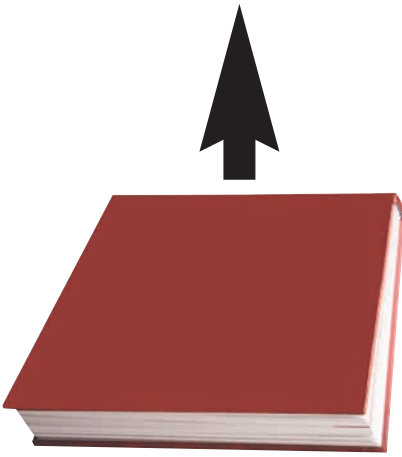

BOOK CIRCUIT TARGET



Project A11

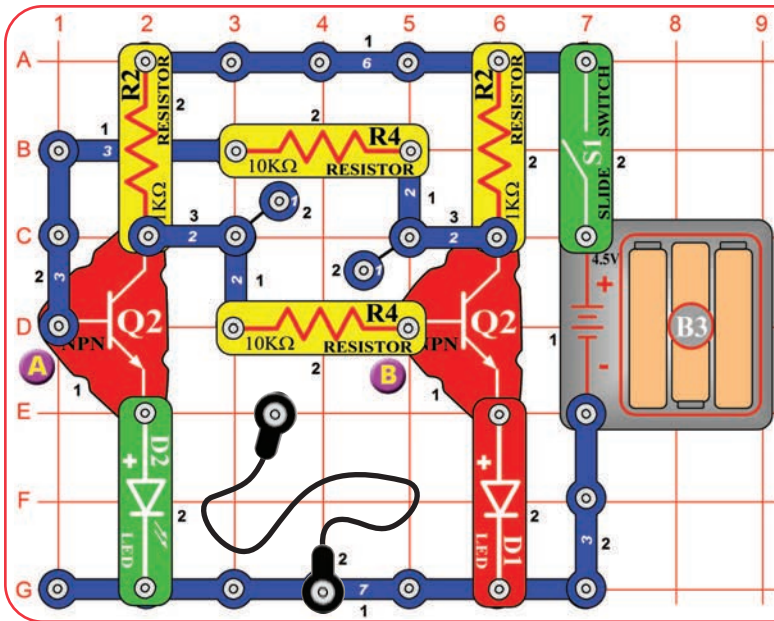

This circuit is known as a “flip-flop” due to the way it operates. Variations of this circuit form one of the basic building blocks for computers. This circuit can be thought of as a memory because it only changes states when you tell it to, it “remembers” what you told it to do, even though you removed the loose wire. By combining several of these circuits, you can remember a letter or number. A typical computer has thousands of flip-flops, in miniaturized form.

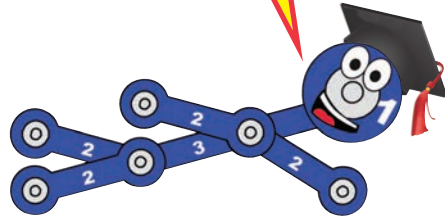

Build the circuit, leaving one end of the black jumper wire unconnected. Turn on the switch (S1). One LED (D1 or D2) will be on, the other off. Alternately touch the loose end of the black jumper wire to the snaps marked “A” and “B” in the drawing. When you do, both LEDs change between on and off. One LED “flips” on and the other “flops” off.



Project A12

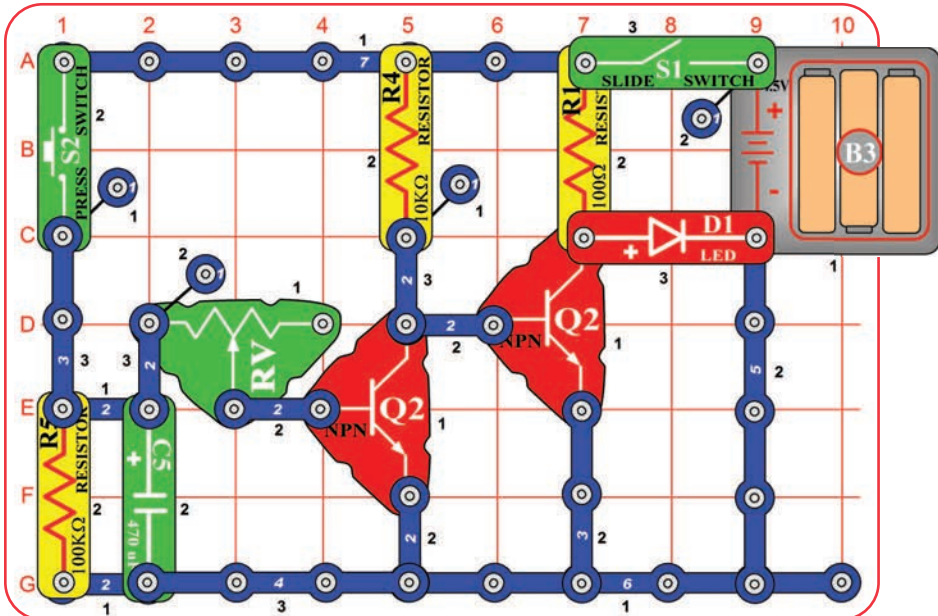

Adjustable Light Timer

Build the circuit, turn on the slide switch (S1), and push the press switch (S2). The red LED (D1) will be on for a little while. Push the press switch again to turn the LED back on. Move the lever on the adjustable resistor (RV) to adjust how long the LED stays on for.



Project A13

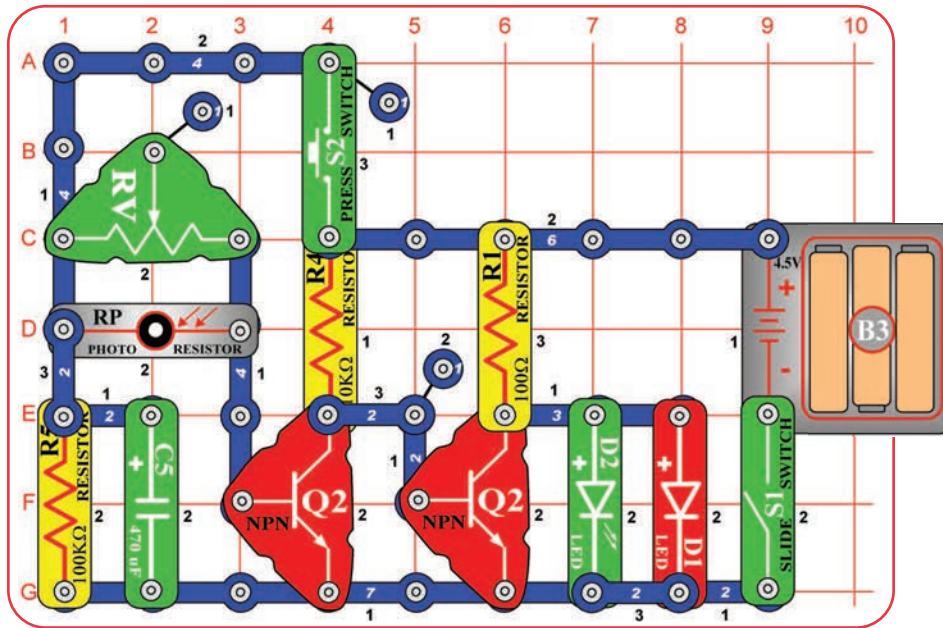

Light Sensitive Timer

Build the circuit, turn on the slide switch (S1), and push the press switch (S2). The LEDs (D1 & D2) light for a while and then turn off. Push the press switch again to turn the LEDs back on. The brighter the light shining into the photoresistor, the faster the LEDs turn off.

The adjustable resistor is used as a fixed resistor in this circuit, so moving its lever won't change anything.

Notice how the green LED turns off a little faster than the red LED. The LEDs are made from different materials, and the red LED is a little more sensitive to electricity than the green LED.

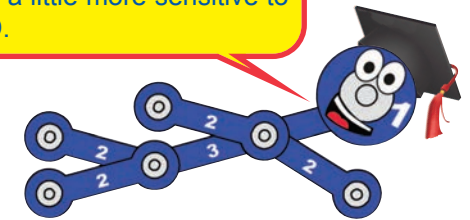

Project A14

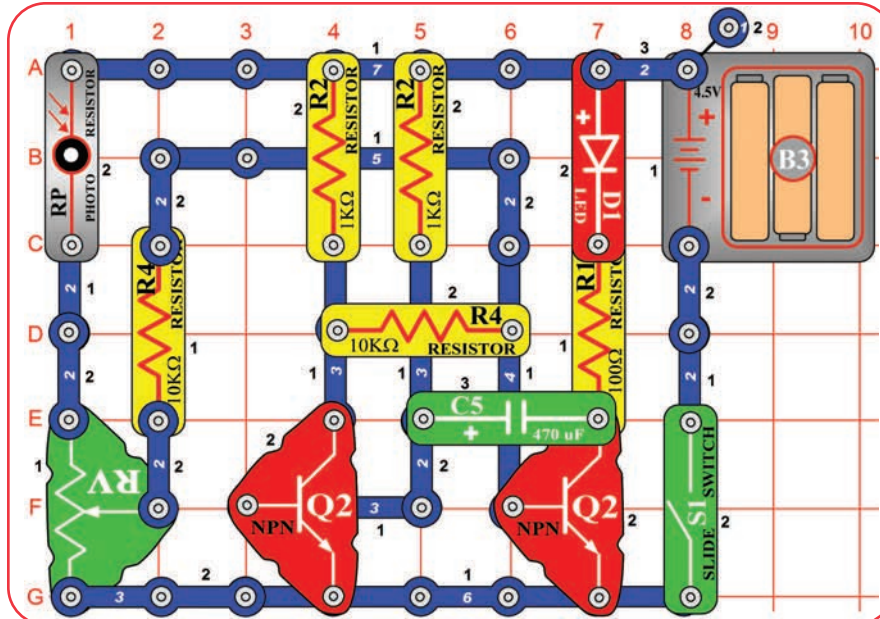

Shot in the Dark

You need a flashlight for this project. Build the circuit, and note that there is a 3-snap wire across base grid locations F3-F5, which is under the left NPN transistor (Q2). Turn on the slide switch (S1).

Take the circuit into a dark room. Shine the flashlight into the photoresistor (RP), and carefully move the lever on the adjustable resistor (RV) until the red LED (D1) lights. You will use the flashlight as a gun, and "shoot" at the photoresistor.

Keep the room dark and move away from the circuit. "Shoot" your flashlight by quickly switching it on and off. Try to hit the photoresistor with the light beam from the flashlight. When you are on target, the red LED will light. You can have contests with your friends to see who has the best aim.

Project A15 Microphone Control

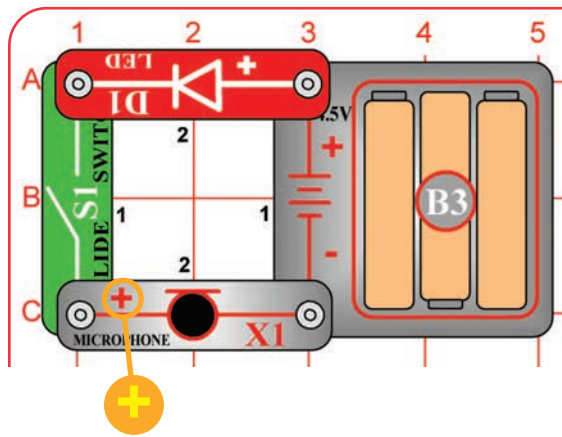

In this circuit, blowing on the microphone (X1) changes the LED (D1) brightness.

The resistance of the microphone changes when you blow on it. You can replace the microphone with one of the resistors to see what resistor value it is closest to.

Project A16 Adjustable Brightness

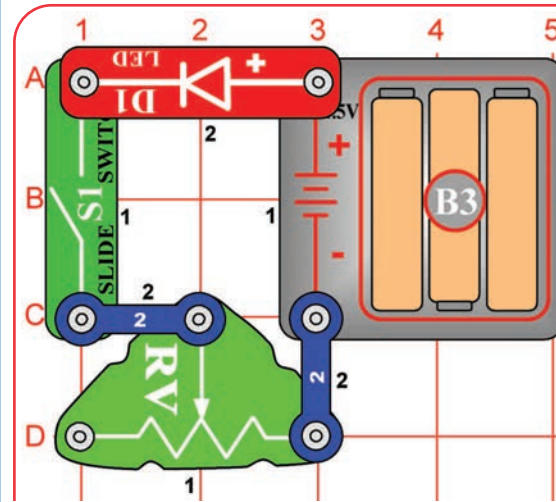

In this circuit, changing the adjustable resistor (RV) setting changes the brightness of the LED (D1).

The lever on RV adjusts how much resistive material the electric current flows through.

Project A17

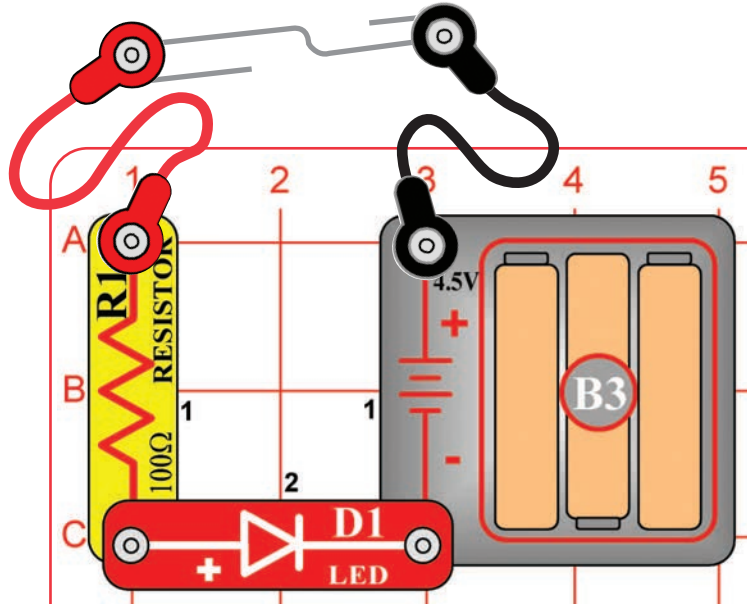

Conduction Detector

Build the circuit, but leave the ends of the red and black jumper wires unconnected at first.

When you place a metal paper clip (not included) across the loose ends of the jumper wires as shown, current flows from the batteries through the resistor, through the LED, and back to the battery. The paper clip completes the circuit and current flows through the LED. Place your fingers across the terminals and the LED does not light. Your body is too high of a resistance to allow enough current to flow to light the LED. If the voltage, which is electrical pressure, was higher, current could be pushed through your fingers and the LED would light. This detector can be used to see if materials like plastic, wood, cloth, aluminum, or paper are a good conductor or a poor conductor.



Project A18

Slider

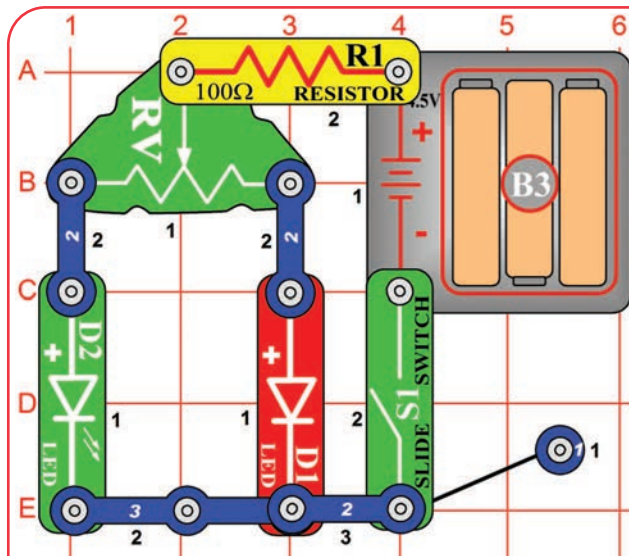

Turn on the circuit using the slide switch (S1) and move the adjustable resistor's (RV) control lever around to adjust the brightness of the LEDs (D1 & D2). When the adjustable resistor is set to one side, that side will have low resistance and its LED will be bright (assuming the switch on that side is ON) while the other LED will be dim or OFF.



Project A19 Parallel Resistors

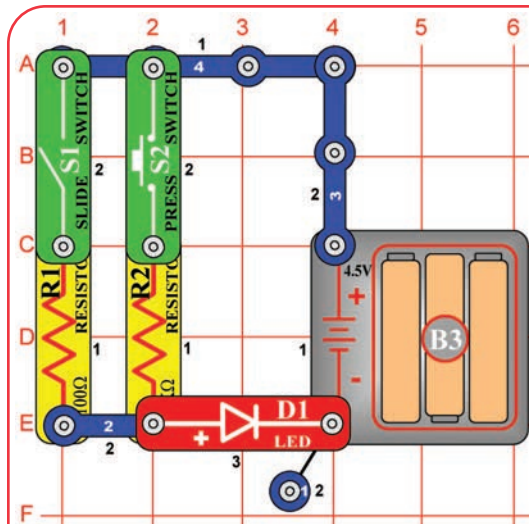

Turn on either or both switches (S1 & S2) and compare the LED (D1) brightness. This circuit has the 100Ω resistor (R1) and 1kΩ resistor (R2) arranged in parallel. The smaller 100Ω resistor controls the brightness in this arrangement. You can replace either resistor with any other resistor and compare the effect.



Project A20 Series Resistors

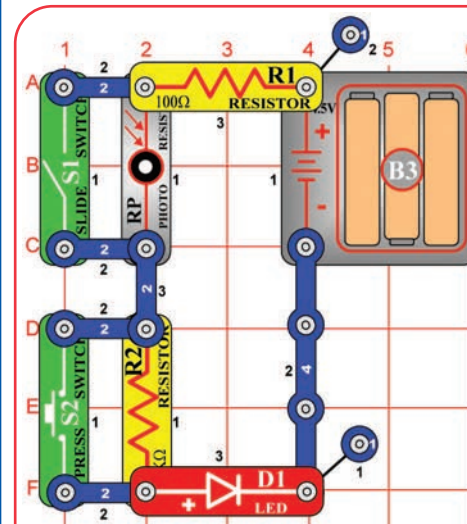

Turn on either or both switches (S1 & S2) and compare the LED (D1) brightness. This circuit has the 100Ω resistor (R1), the 1kΩ resistor (R2), and the photoresistor (RP) arranged in series. The switches are used to bypass the larger resistors. The largest resistor controls the brightness in this arrangement. The resistance of the photoresistor will be much higher than the others, unless the light is very bright.



Project #A21

Flying Saucer

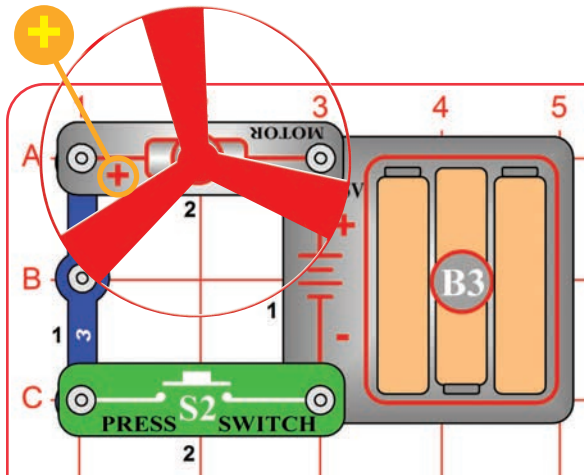

The air is being blown down through the blade and the motor rotation locks the fan on the shaft. When the motor is turned off, the blade unlocks from the shaft and is free to act as a propeller and fly through the air. If speed of rotation is too slow, the fan will remain on the motor shaft because it does not have enough lift to propel it.

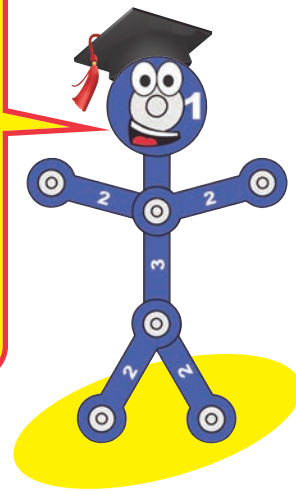

Push the press switch (S2) until the motor reaches full speed, then release it. The fan blade should rise and float through the air like a flying saucer. Be careful not to look directly down on fan blade when it is spinning.

If the fan doesn't fly off, then press the switch several times rapidly when it is at full speed. The motor spins faster when the batteries are new.

WARNING: Moving parts. Do not touch the fan or motor during operation. Do not lean over the motor. Fan may not rise until switch is released.



Project #A22

Transistor

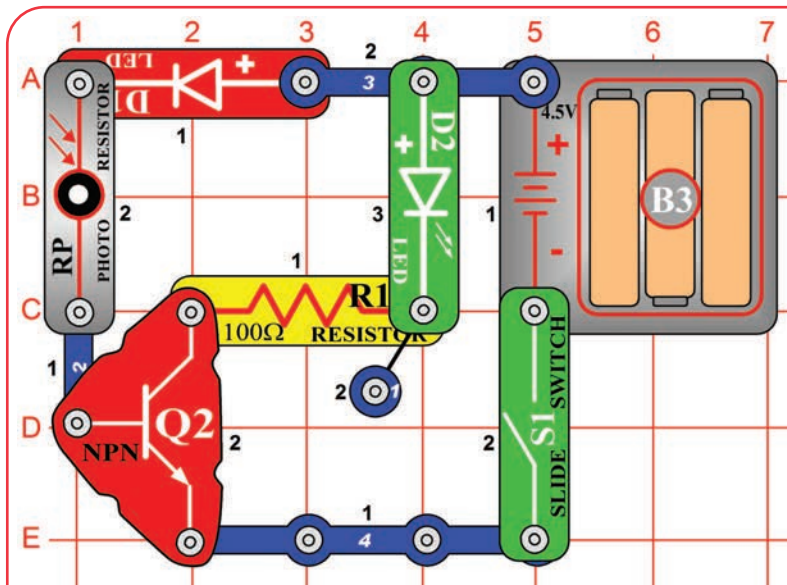

Build the circuit, turn on the slide switch (S1), and adjust the amount of light shining on the photoresistor (RP). Compare the brightness of the red and green LEDs (D1 & D2) as you change the light on the photoresistor.

The resistance of the photoresistor decreases as more light shines on it, so the red LED gets brighter as the light is increased. The transistor (Q2) amplifies the current through the photoresistor and red LED, to produce a larger current through the green LED, making it brighter than the red LED.

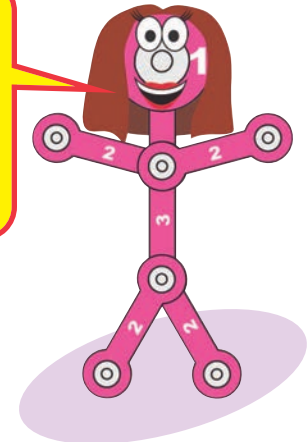



Project A23

Capacitor Battery

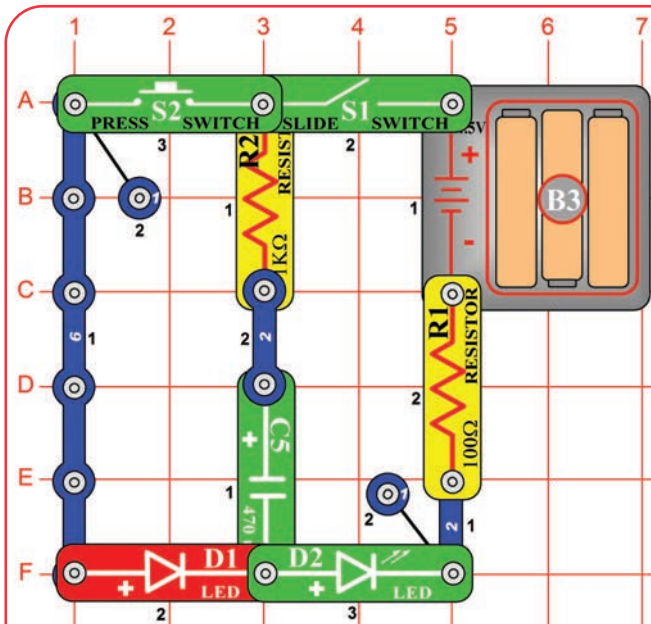

Capacitors store electricity in an electric field between metal plates, with a small separation between them. This electric field is similar to the magnetic field of a magnet. Compared to batteries (which store energy as separated chemicals), capacitors can only store small amounts of energy, but they can release it quickly, can be made in very small sizes, and are inexpensive.

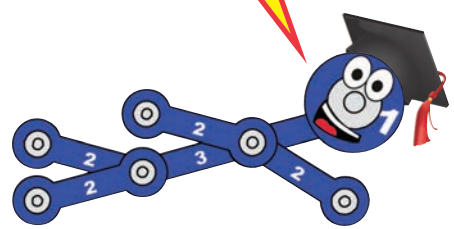

This circuit shows how a capacitor can store and release electrical energy.

Turn on the slide switch (S1) for a few seconds, then turn it off. The green LED (D2) flashes dimly for a moment, and then goes dark as the batteries (B3) charge up the 470µF capacitor (C5). The capacitor is storing electrical energy, as if it were a small battery.

Now press the press switch (S2) for a few seconds. The red LED (D1) is initially bright but goes dim as the capacitor discharges itself through it.

The capacitor value (470µF) sets how much electricity can be stored in it, and the resistor value (1kΩ) sets how quickly that electricity can be stored or released.



Project A24

Blow Off Sound

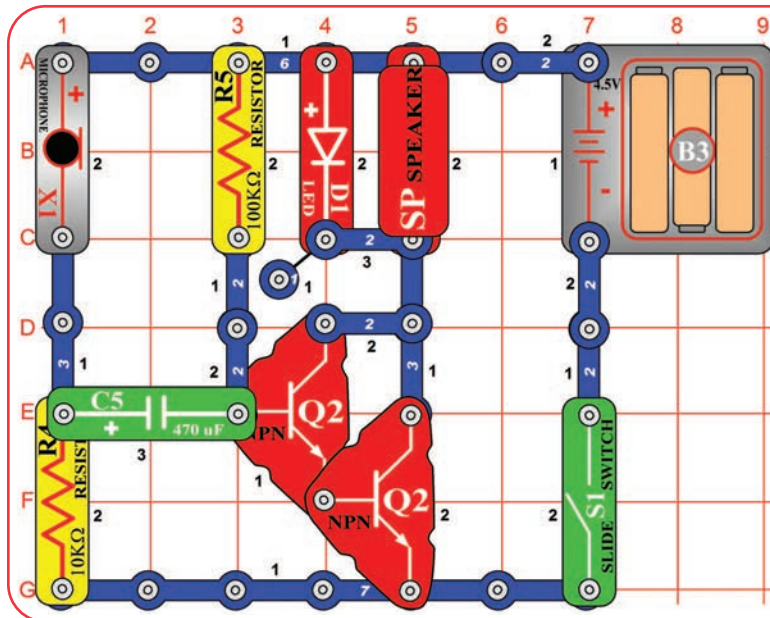

Turn on the slide (S1) and blow into the microphone (X1). The red LED(D1) will flicker and you hear static from the speaker (SP).

Talk loudly into the microphone. You can hear your voice on the speaker, though it may be badly distorted.



Project #A25

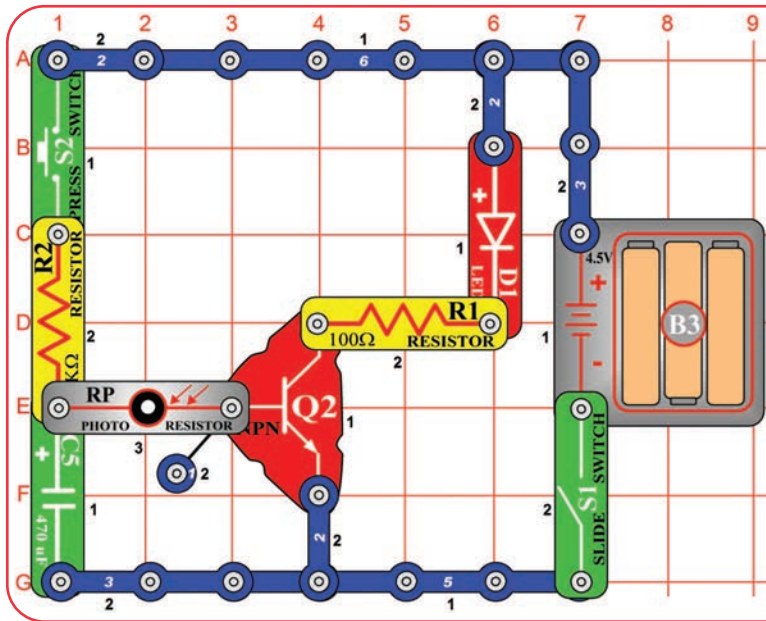

Capacitor Photo Control

The energy stored in the 470µF capacitor (C5) keeps the controlling current to the NPN transistor (Q2) on even though the press switch was turned off. If it is dark, the high resistance of the photoresistor shuts off the current to the transistor.

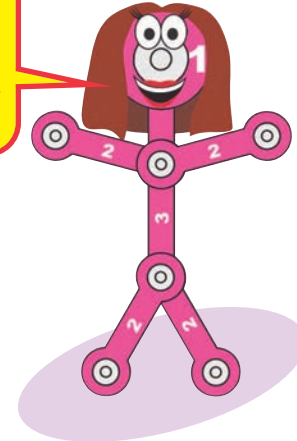

Turn on the slide switch (S1) and press the press switch (S2). If there is light on the photoresistor (RP), then the LED (D1) will stay on for a long time after you release the press switch.



Project #A26

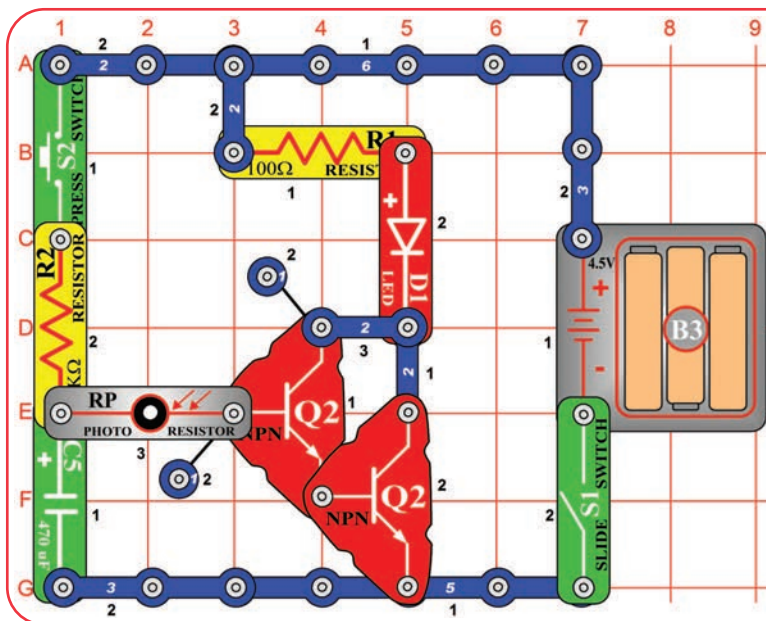

Capacitor Photo Control with Slow Shut-off

Adding a second transistor makes the circuit more sensitive to current from the capacitor and photoresistor, so the LED stays on longer. Transistors allow very small currents to control large currents.

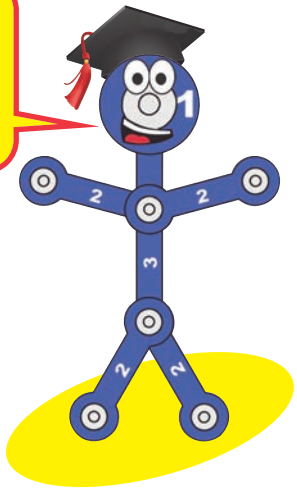

Modify the preceding circuit to match the one shown here. It works the same way, but the red LED (D1) stays on longer and very little light is needed on the photoresistor (RP).



Project #A27

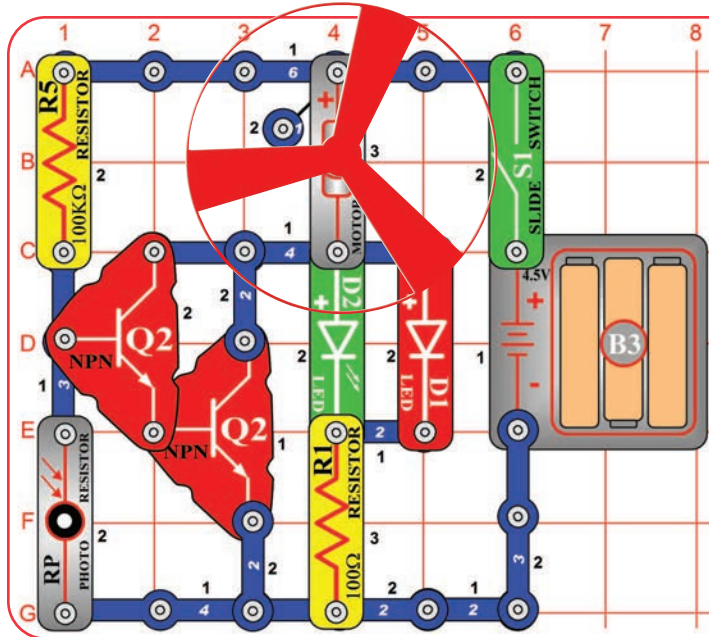

Turn on the slide switch (S1). If there is light on the photoresistor (RP) then the LEDs (D1 & D2) will be on. Cover the photoresistor to switch off the LEDs and switch on the motor (M1).

WARNING: Moving parts. Do not touch the fan or motor during operation. Do not lean over the motor.



Project #A28

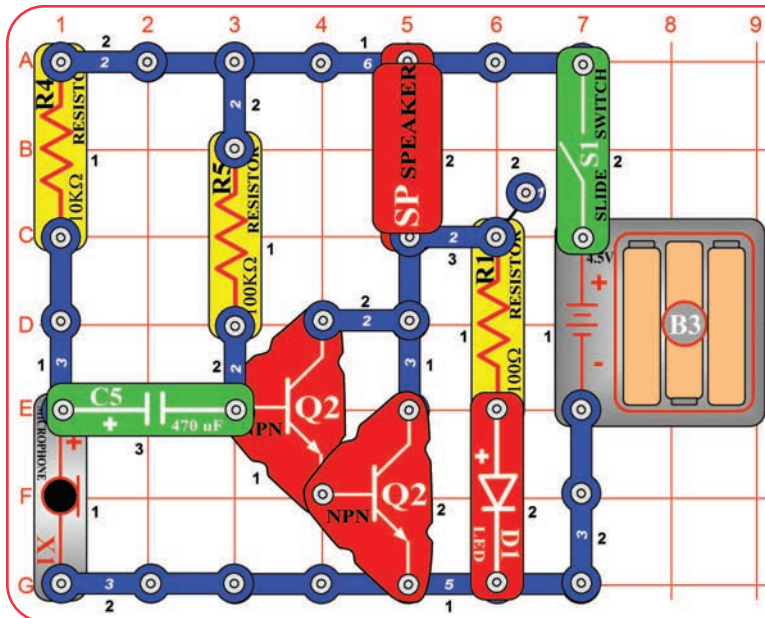

Turn on the slide switch (S1) and blow into the microphone (X1). The red LED(D1) will flicker and you hear static from the speaker (SP).
Talk loudly into the microphone. You can hear your voice on the speaker, though it may be badly distorted.

Blow On Sound



Project #A29

Scratchy Amplifier

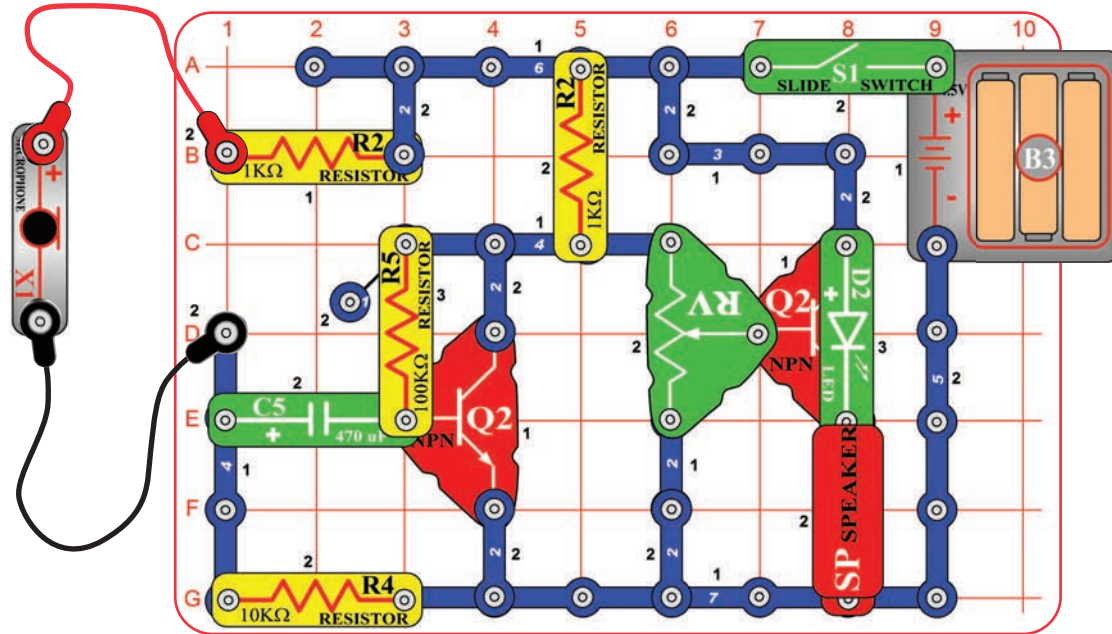

Set the adjustable resistor (RV) control lever to the top and turn on the slide switch (S1). Talk or blow into the microphone (X1). You should hear your voice on the speaker (SP) and the green LED (D2) flashes.

Your voice will not be very loud and may be badly distorted. Adjust the adjustable resistor lever for the best sound.



Project A30

One Shot

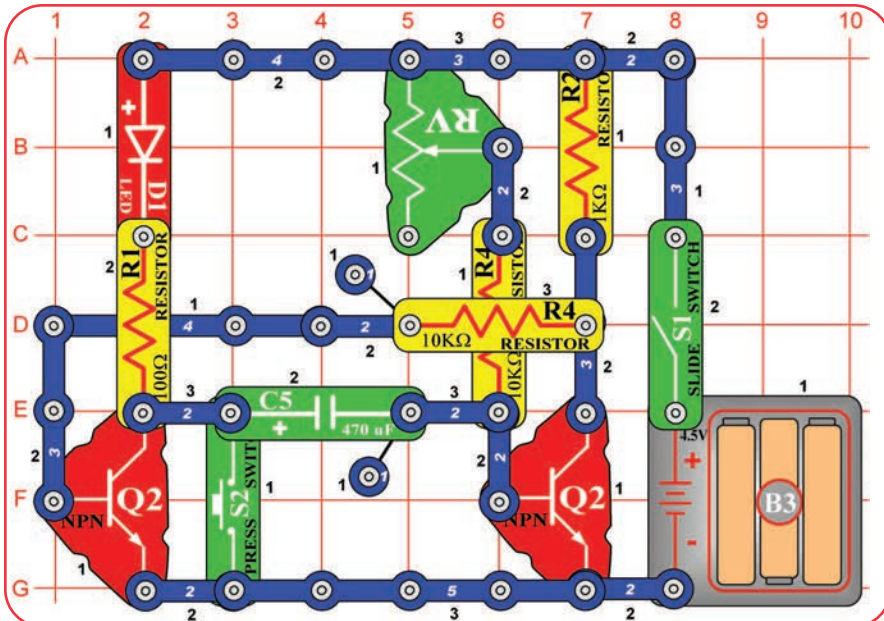

Build the circuit, turn on the slide switch (S1), and push the press switch (S2). The red LED (D1) will be on for a while and then go off. Push the press switch again to turn the red LED on again. Use the lever on the adjustable resistor (RV) to control how long the red LED stays on for.

This circuit can be used as a timer. You might use a circuit like this in a microwave oven. You press the switch to turn the oven on and have a knob (like the adjustable resistor) to adjust how long the oven stays on; it then shuts off automatically.

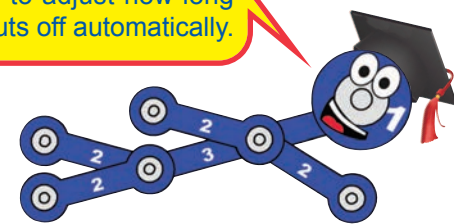

PART B - Microcontroller Projects

Introduction

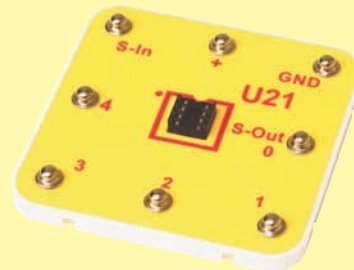
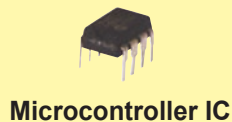

8-pin socket on Snap Circuits® platform



Microcontroller IC module (U21)

The U21 microcontroller IC module (U21) consists of the microcontroller IC in a socket, and mounted on a Snap Circuits® platform. Do not remove the microcontroller from the socket. All

microcontrollers are programmable, but the microcontroller you are using has a special programming interface that makes it very easy to use.

WHAT IS A MICROCONTROLLER?

A microcontroller is a mini computer. It's a miniaturized circuit that contains memory, logic, processing, and input/output circuitry. Microcontrollers are programmed with specific instructions to control many different devices. Once programmed the microcontroller is built into a product to make the product more intelligent and easier to use.

A microcontroller receives input (such sources such as a switch, microphone, photoresistor, or computer keyboard), processes it and makes decisions, then controls outputs (such as an LED, speaker, motor, or computer display) based on the decisions.

For example, a microwave oven uses a single microcontroller to process information from the keypad, display user information on a display, and control the turntable motor, light, bell and cooking time.



One microcontroller can often replace a number of separate parts, or even a number of complete electronic circuits.

Microcontrollers are used in household appliances, alarm systems, medical equipment, vehicle subsystems, musical instruments, and electronic instrumentation.

Most cars contain many micro-controllers, using them for engine management, remote locking, and other functions.

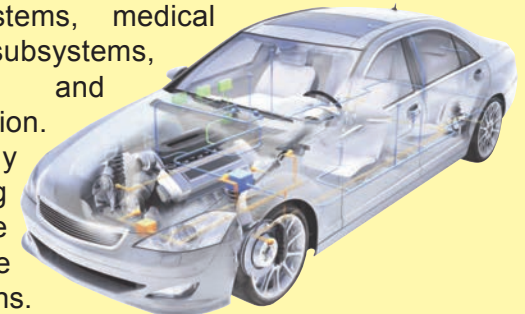

Programs are stored in memory as a series of numbers. A program is executed by moving information (stored as numbers) between places, such as activity registers, input/output ports, and memory. Computers cannot do complex mathematics, but they can perform simple math very quickly, and programming tricks allow complex calculations to be performed as a series of simple ones.



Project B1

Blinker (Programming the Microcontroller)

This project explains the procedure for re-programming the microcontroller (U21). The **microcontroller can be re-programmed in ANY circuit** that uses it (including projects A3-A10), **by attaching the programming cable to it**. When you initiate a new program download, any program currently running in the microcontroller is interrupted. When a new program download is complete, the new program will begin running.

The programming cable is needed to download new programs to the microcontroller, and to allow some programs to transfer information to/from the computer's display. The programming cable may be removed from a circuit when not being used.

Installing Software and Programming Cable

Requirements for your computer

Windows® XP (or later) or Mac OSX 10.4 (or later) or Linux x386 with GTK2.8 (or later), 512MB RAM, 500MB of hard-disk space, USB port, and an internet connection.

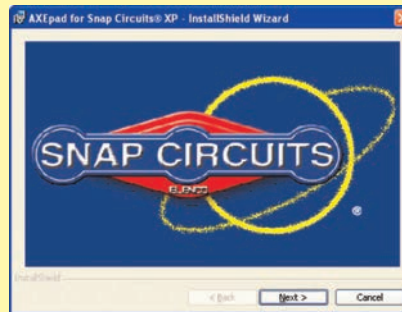

STEP 1

Download the AXEpad for Snap Circuits® XP™ software from the appropriate link below, then follow the instructions to install it.

Windows - <http://www.elenco.com/downloads/WinAXEpad.zip>

Mac - <http://www.elenco.com/downloads/macaxepad.app.tar.gz>

Linux - <http://www.elenco.com/downloads/linaxepad.tar.gz>

Go to the download and extract the compressed files. Open the extracted files folder and run the appropriate file for your system (such as winaxepad.exe for Windows users, and MacAXEpad.app.tar for Mac users).

Note: the programming cable should NOT be connected during this installation. Mac users may need to change their security preferences to allow installation of applications not purchased through the App Store or authenticated by Apple. Contact ELENCO® if you have questions or problems with the installation.

STEP 2 (Windows Users)

Insert the Programming Cable into a USB port on your computer. The Programming Cable will automatically configure itself. If you have problems with configuration then contact ELENCO®.



Programming Cable

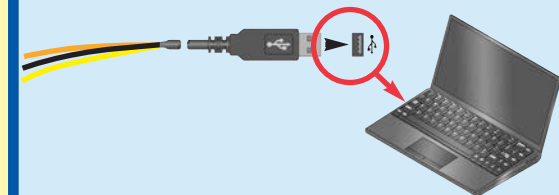

Installing Software and Programming Cable

STEP 2 (Mac Users)

1. Install USB driver software (**Do not insert the cable yet!**). Insert the CD provided into your computer and open the Mac USB Driver folder.

If your Mac has an Intel processor:

Click on the “Mac_intel.dmg.zip” file and follow the instructions that appear on the dialog box. You may also access this file online at the following address:

http://www.rev-ed.co.uk/software/axe027_mac_intel.dmg.zip

For older Macs:

Click on the “Mac_powerpc.dmg.zip” file and follow the instructions that appear on the dialog box. You may also access this file online at the following address:

http://www.rev-ed.co.uk/software/axe027_mac_powerpc.dmg.zip

2. Once installation is complete, the computer will need to be rebooted.

3. After the computer has rebooted, plug in the Programming Cable.
4. Open MacAXEpad. Go to View > Options > Port and click on the “USB Setup” button. A dialog box will open with the serial number for the cable that will look like this: /dev/tty.usbserial-xxxxxxx – where xxxxxxxx is the serial number of the cable (e.g. FTT6KHLX). Copy this number down on a piece of paper (note: this number is case sensitive), close the dialog box, and enter in the correct serial number into the white box. Click OK to close the dialog box.

Your cable should now work with the MacAXEpad program.

For clarifications, visual aids, and updates, please visit our website:

www.snapticcircuits.net

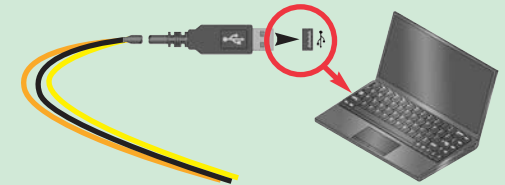

How to Use AXEpad

STEP 3

Build the circuit on the left, and attach the programming cable to it as shown. Turn on the slide switch (S1).

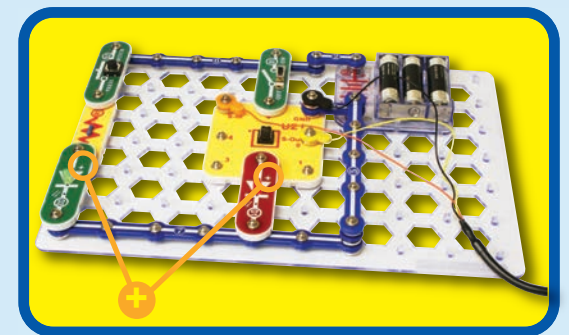
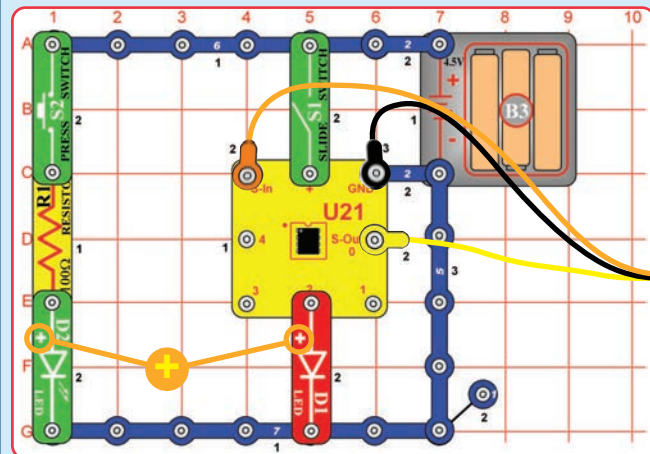

How to Use AXEpad

STEP 4

Double-click the AXEpad for Snap Circuits® XP™ icon on your desktop (unless you directed that it be installed somewhere else) to start the AXEpad for Snap Circuits® XP™ software. The software screen should look similar to the one shown below. (**Note for Mac users:** The software screen will not have any icons along the top.)

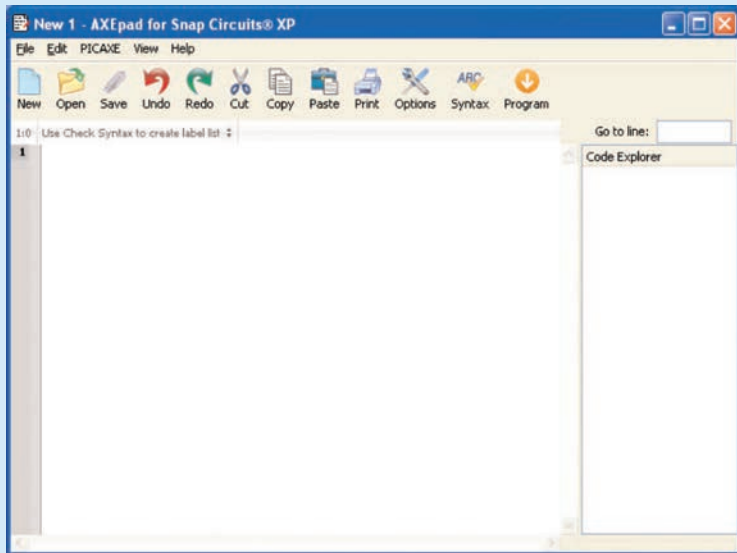
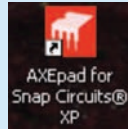

Any time a task needs to be performed over and over again, a microprocessor or computer on a chip should be considered to help perform the task.

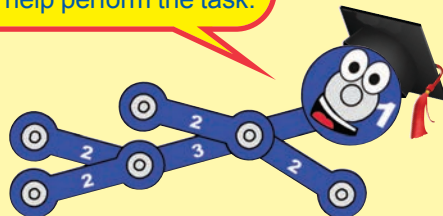

STEP 5

Select **File**, then **Open Snap Circuits Samples ...**, and then pick the program you want to download to the microcontroller. Choose the Blinker program for the circuit you are building now.

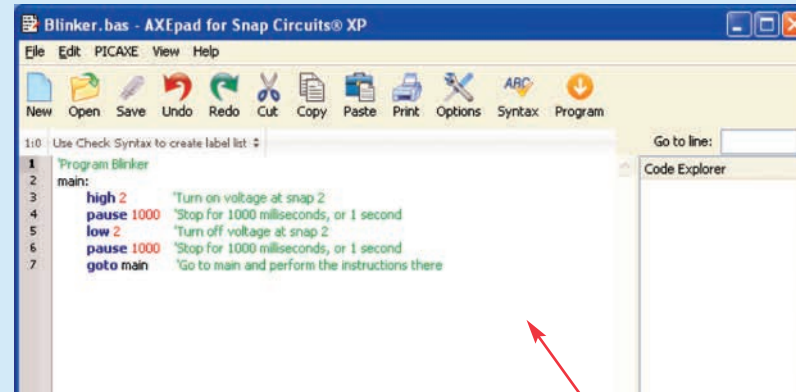
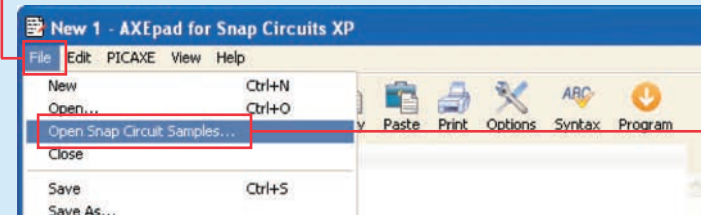

The program you chose will appear in the **editor space**.

The procedure for programming the microcontroller for the other projects is the same as you are doing here, except the program name will be different.

Introductory projects A3-A10 require the program Electronic Brain to be loaded in the microcontroller. This program was loaded into the microcontroller at our factory. If the microcontroller has been reprogrammed, then you will need to reload Electronic Brain to do the introductory projects.

How to Use AXEpad

STEP 6

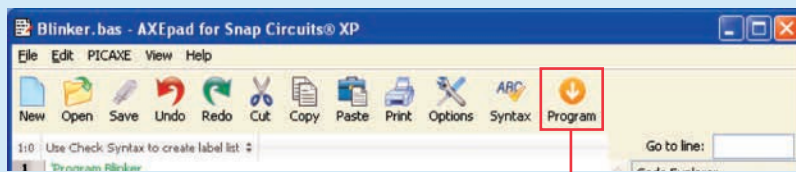

Click **Program** to download your program to the microcontroller. This will interrupt and erase the program currently in the microcontroller. (**Note for Mac users:** Since there is no Program icon, you must click on the PICAXE menu tab and select **Program**, or simply press F5 on your keyboard.) A window will open for the download process, like the one shown here:

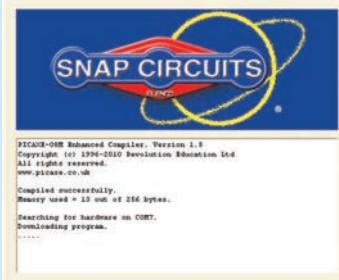

Window for Downloading Process

If an error message appears, see Troubleshooting.

A message will tell you when the new program download is complete, and the new program will begin running.

If you turn off the microcontroller, the program in it will restart when the microcontroller is turned back on.

The programming cable may be removed after the program download is finished; it is usually not needed for running the program. Some Snap Circuits® XP™ projects will use the cable to enter or display information using the computer screen while a program is running, these will tell you to keep the cable connected after program download.

STEP 7

The Blinker program should now be running in the microcontroller, and the red LED (D1) should be blinking.

Push the press switch (S2) several times to make the green LED (D2) blink. Try to make the green LED blink at the same rate as the red LED. It is probably much easier to let the microcontroller blink the red LED, rather than blink the green LED by pressing the switch.

TROUBLESHOOTING

If you get an error while trying to download a program, start the download and then **reset the microcontroller** (turn slide switch S1 off and on) **just after the words “Downloading program” are displayed**. A running program will be interrupted by a new download when it executes a command, but some commands (such as long pause or wait commands) can take too long to complete, so the download could be ignored. Resetting the microcontroller just after initiating a download ensures that the microcontroller will recognize the new download. If you still can't download, use the Advanced Troubleshooting procedure on page 8.

If you get an error saying the **Download Cable cannot be found**: make sure you have the Programming Cable connected. If this is the first time using your programming cable, you may need to manually select the communication port for it. (Note: the Download Cable is your Programming Cable.) For Windows® Computers: select **Options** then **Port** then pick a **COM port** to try (pick the highest-numbered port first). Close the Options window and try to **Program** again.

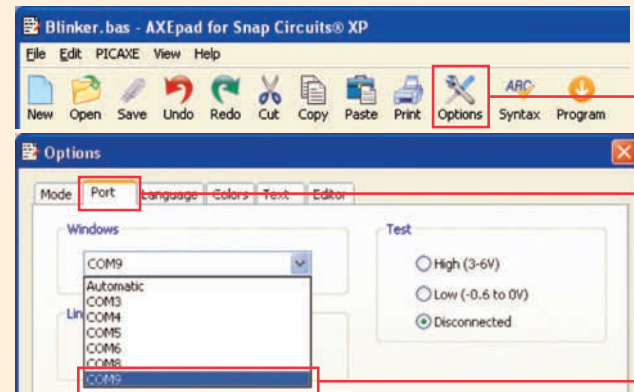

OPTIONAL - TO LEARN ABOUT PROGRAMMING

You can edit the program to change parameters or commands if desired. The editing procedure is similar to other Windows® word processors. You may also type in a completely new program. To save programs you have created or modified, use **Save As** under **File** menu.

Only valid programs (without errors) may be downloaded, or a downloading error will result. You can check for errors by clicking the **Syntax** box, and then clicking **Program**. **Syntax** also tells you how much memory the program uses; programs must be of 256 bytes of memory or less. All Snap Circuits® XP™ programs have already been checked for errors.

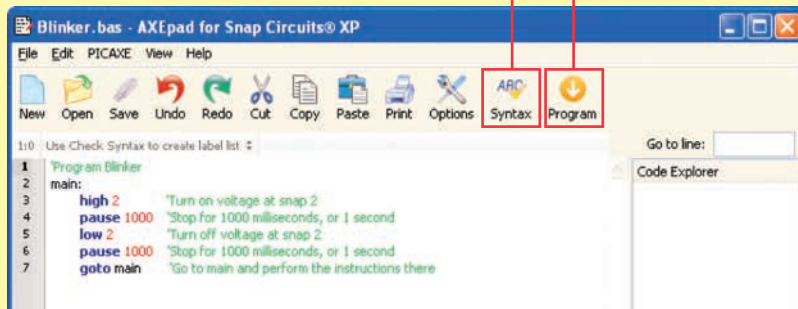

Here is how the program works:

high 2 - this tells the microcontroller to put an electrical voltage at out put 2 (where the red LED is connected). This voltage will light the LED.

pause 1000 - this tells the microcontroller to pause for 1000 milliseconds, or 1 second, before performing the next instruction.

low 2 - this tells the microcontroller to turn off or remove any voltage at output 2. This will turn off the red LED.

goto main - this tells the microcontroller to execute the instructions next to "main:", which here means repeating the instruction set. This causes the LED to turn on and off, blinking continuously.

Explanations for all the microcontroller commands, and some basic information about programming, can be found under the **Help menu** at Snap Circuits® XP™.

Use this file to look up a command you want to learn about. If you later want to write your own programs, you'll need to use this often. Part C - To Go Further (page 59) has other useful information.

The PICAXE® Manual (Parts 1, 2, and 3) has more detailed explanations of the PICAXE® commands, and other information about PICAXE® products, however much of this information is not applicable to Snap Circuits® XP™ and some is very technical. The Snap Circuits® XP™ help file is customized to your product.

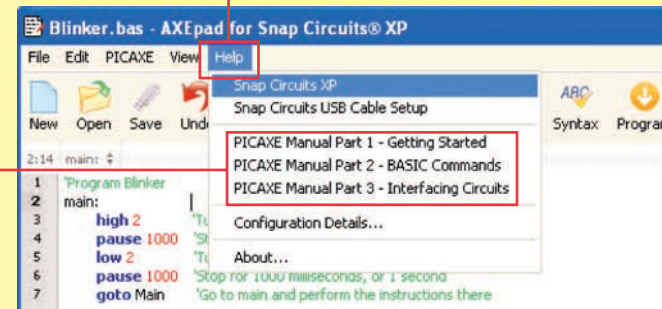

Information after an apostrophe (') symbol is **Comments**. Comments are a description of what the program is doing, to help you understand and remember it. Comments are ignored by the microcontroller.

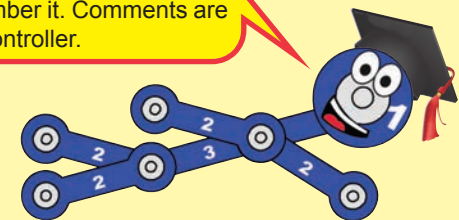



Project B2

Blinkers

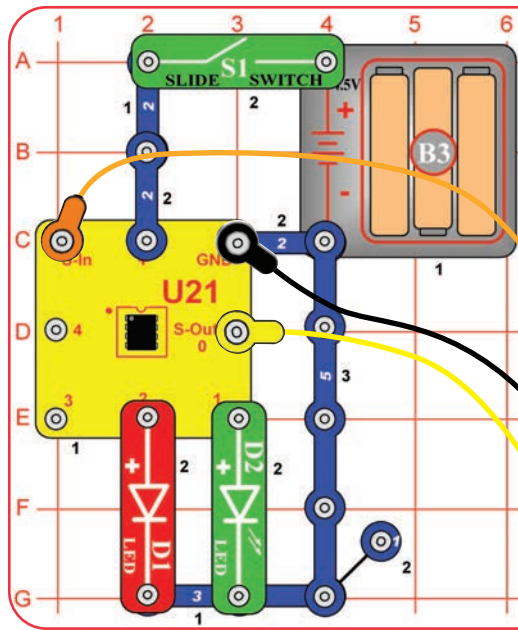

Build this circuit and turn on the switch (S1). Load program Blinkers into the microcontroller using the programming instructions in project B1. The microcontroller controls the red and green LEDs (D1 & D2), and alternates turning them on and off.

Now download one of the other Blinkers programs (Blinkers Together, Blinkers Faster, or Blinkers Uneven) into the microcontroller using the same procedure as in project B1. The Blinkers programs change the LEDs' blinking pattern.

You can download a new program into the microcontroller while it is running another program; the running program will be interrupted and the new program started. The programming cable only needs to be connected while downloading a program into the microcontroller.

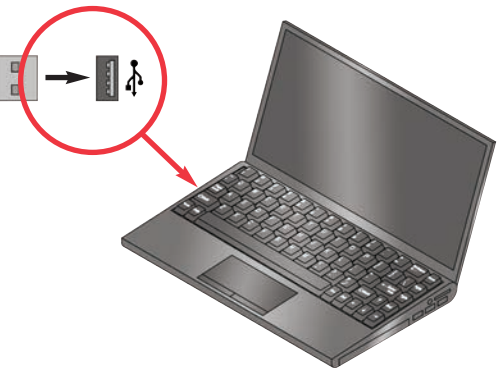

Optional:

You can change the blink rate by editing the PAUSE times in the program, then re-downloading it to the microcontroller.

The PAUSE time must be a whole number between 0 and 65535. This is a delay in milliseconds (1/1000 second) between program commands. You can change the PAUSE times in any of the Blinkers programs and see the effect. Do not change anything else in the program. The program at right is the Blinkers program.

Only valid programs (without errors) may be downloaded, or a downloading error will result. You can check for errors by selecting Syntax.

```
'Program Blinkers
main:
  high 1
  low 2
  pause 1000
  low 1
  high 2
  pause 1000
  goto main
```

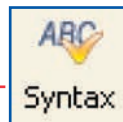

The microcontroller lets you control the LEDs in ways that would be difficult to do using switches or other devices.

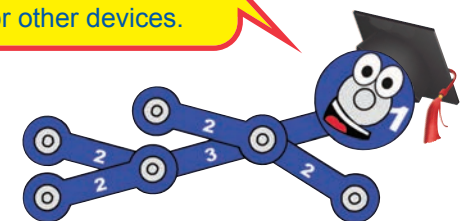



Project B3

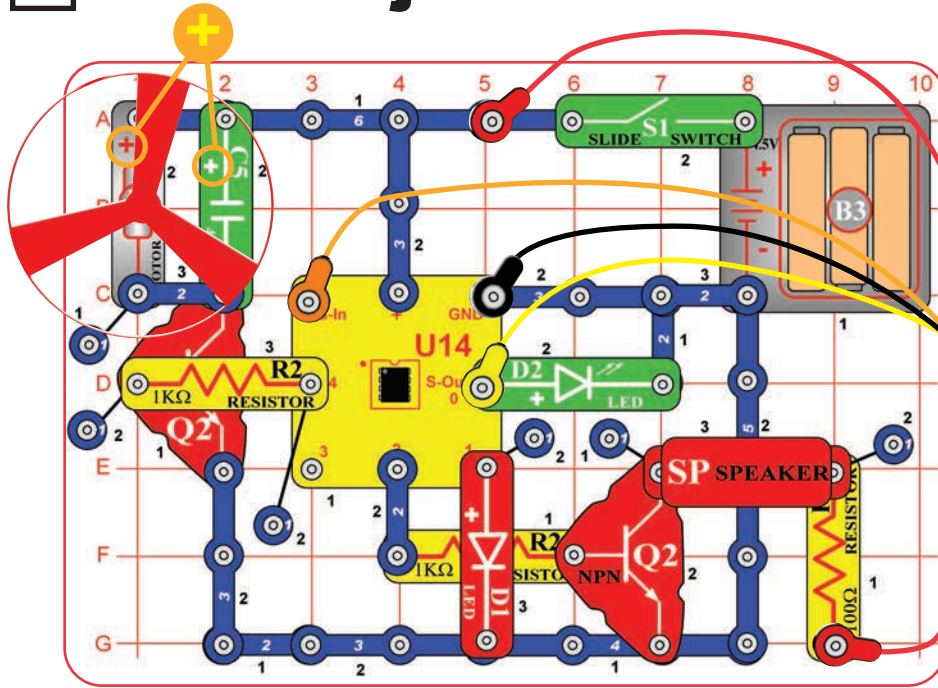

Four Outputs

Build this circuit and turn on the switch (S1). Load program Four Outputs into the microcontroller using the programming instructions in project B1.

The microcontroller controls four outputs - the speaker, green LED, red LED, and motor - and turns them on and off in sequence. Try doing that without a microcontroller!

Now download program Four Outputs Faster or Four Outputs Together into the microcontroller. The circuit performs a little differently.



Program Four Outputs

```
main:
  sound 2,(110,100)
  pause 1000
  high 0
  pause 1000
  high 1
  pause 1000
  high 4
  pause 1000
  sound 2,(115,100)
  pause 1000
  low 0
  pause 1000
  low 1
  pause 1000
  low 4
  pause 1000
  goto main
```

Optional:

You can change the blink rate by editing the PAUSE times in the program, then re-downloading it to the microcontroller. The PAUSE time must be a whole number between 0 and 65535. Do not change anything else in the program. The program at left is the Four Outputs program.

WARNING: Moving parts. Do not touch the fan or motor during operation. Do not lean over the motor.

Microcontrollers are very flexible because they let you change what a circuit does just by reprogramming, and without changing the actual components.

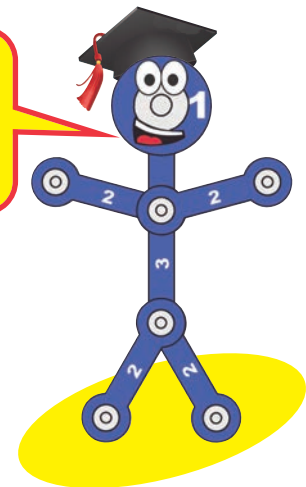



Project B4

Play a Tune

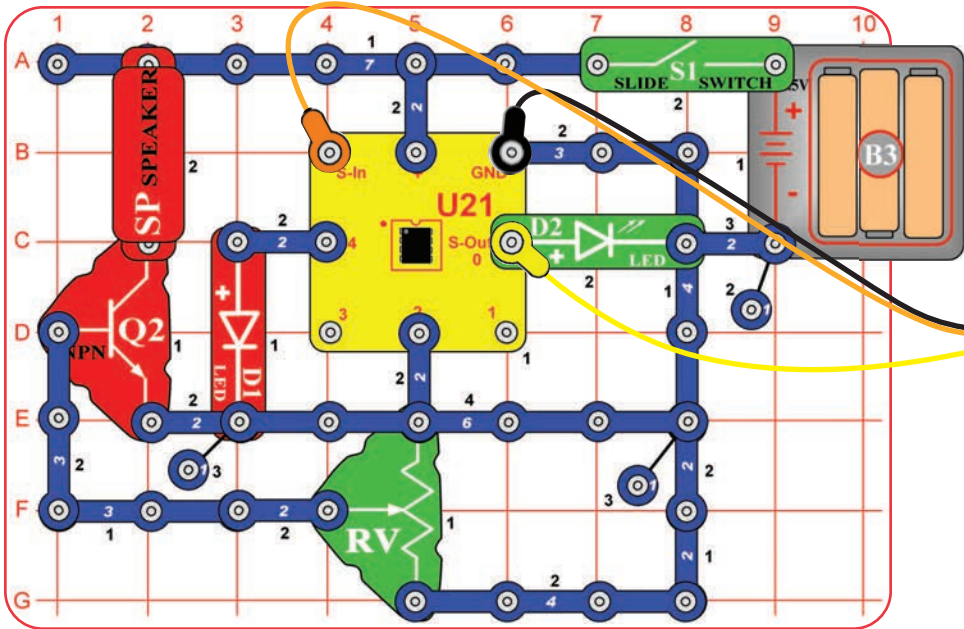

Build the circuit as shown. Turn on the slide switch (S1). Load any of the programs whose name starts with "Song-" (such as Song-PopGoesWeasel) into the microcontroller (U21) using the programming instructions in project B1. Program Piano can also be used.

The microcontroller will play a tune and may flash some lights. Use the lever on the adjustable resistor (RV) to adjust the volume.



Optional:

You can adjust the tempo of the song by changing the **second number** in the Tune command of this program to any whole number from 1 (fast) to 15 (slow), then re-download. Do not change anything else in the program.

'Pop Goes the Weasel

tune 3, 4, (\$27,\$00,\$2C,\$00,\$02,\$6C,\$02,\$44,\$47,\$04,\$00,\$2C,\$27,\$0

Many more tunes are available for your PICAXE® 08M microcontroller:

http://www.rev-ed.co.uk/software/tunes1_1.zip (450 tunes)

http://www.rev-ed.co.uk/software/tunes2_1.zip (350 tunes)

http://www.rev-ed.co.uk/software/christmas_1.zip (72 Christmas Songs)

http://www.rev-ed.co.uk/software/tvthemes_1.zip (48 TV & Movie tunes)

http://www.rev-ed.co.uk/software/anthems_1.zip (15 national anthems)

These files must be downloaded and unzipped into a new folder on your computer. Then they can be downloaded into your microcontroller from that folder.

The Tune command produces musical notes (in the form of an electrical voltage) on output 2.

It is possible to create your own music using the tune command, but this is not recommended because the coding method is complicated and not easy to use. Programming Editor (a more advanced version of PICAXE software) has a Tune Wizard that makes creating or importing music easy. See page 59 for more information about Programming Editor.

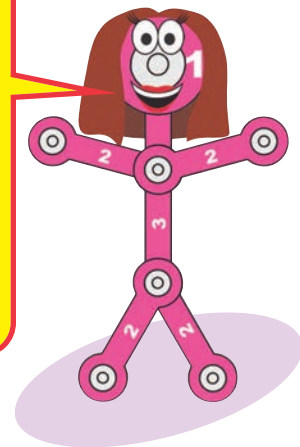



Project B5

Computer Music Box

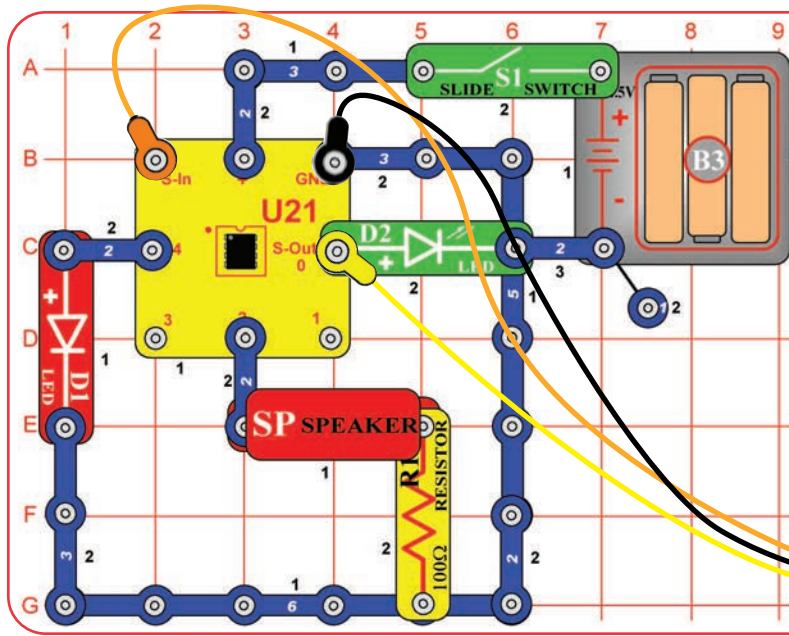

The microcontroller can be programmed to produce cute sounds in different ways. This project demonstrates some of them.

Build the circuit shown; it is simpler than the preceding circuit but does not have a volume control. Turn on the slide switch (S1). Load any of the programs listed here into the microcontroller (U21) using the programming instructions in project B1. The microcontroller will play a tune and may flash lights. You have a computer music box!

- A. Use program Computer Music Box.
- B. Use program Make a Sound.
- C. Use program Ascending Sound.
- D. Use program Robotic Sounds.

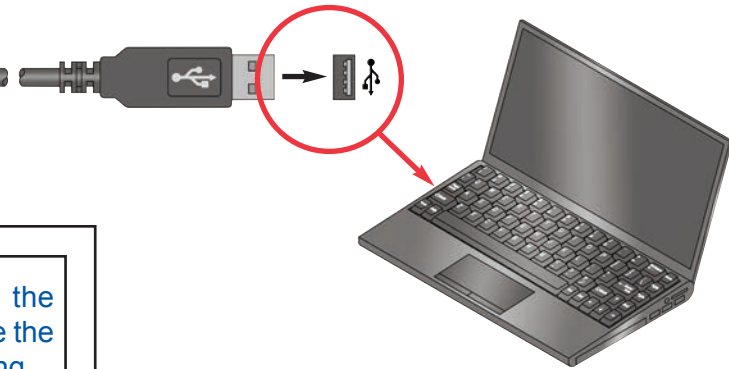

Optional:

'Program Computer Music Box
 main:
 play 0,3
 wait 5
 goto main

This program plays a song in the microcontroller's memory. Change the 0 to a 1, 2, or 3 to change the song.

'Program Make a Sound
 sound 2,(1,100,51,100,101,100,151,100,201,100,251,100)

This program plays a sequence of musical notes. The sequence in parenthesis is the musical notes (ranging from 0 to 255) and their durations (all values here are 100, so each note plays for 1 second).

Optional:

'Program Ascending Sound

main:

```
label_D:   inc b0
           sound 2,(b0,1)
           if b0 > 127 then label_20
           goto label_D
```

This program plays an ascending sequence of notes for very short durations, which combine to make a cute sound. You can change the **110** to any whole number between 0 and 127.

```
label_20:  let b0 = 110
           goto label_D
```

'Program Robotic Sounds

main:

```
           let b0 = 0
           let b1 = 0
label_6:   random b0
           if b0 > 127 then label_18
           let b2 = b0
label_1F:  if b2 < 60 then label_2A
label_54:  let b3 = b1
label_49:  if b3 > 16 then label_5B
           if b3 < 4 then label_87
label_31:  sound 2,(b2,b3)
           pause b1
           goto label_6

label_18:  let b2 = b0 - 127
           toggle 0
           goto label_1F

label_2A:  let b2 = b2 + 65
           toggle 4
           goto label_54

label_5B:  let b3 = b3 - 13
           goto label_49
```

This program plays a sequence of sounds based on the random command. You can change these **zeros** to any whole numbers between 0 and 255. You will have lots of fun seeing how the sounds change when you change these values.

The **Play** command produces a musical tune (in the form of an electrical voltage) on output 2.

The **Wait** command tells the microcontroller to delay before performing the next instruction.

The **Sound** command produces a sequence of musical tones or noise sounds (in the form of electrical voltages) on an output pin.

The **If** command makes decisions.

The **Random** command generates a "random" sequence of numbers that isn't really random. Microcontrollers perform mathematics to generate random numbers, so the sequence produced will be the same each time unless the starting point is changed.

Details on how these commands work can be found under the Help menu at Snap Circuits® XP™.

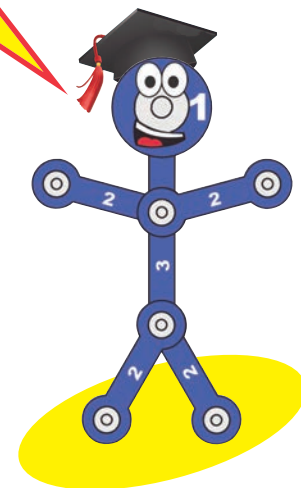
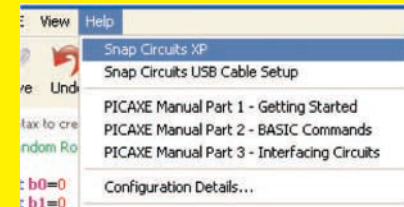



Project B6

Random Sounds

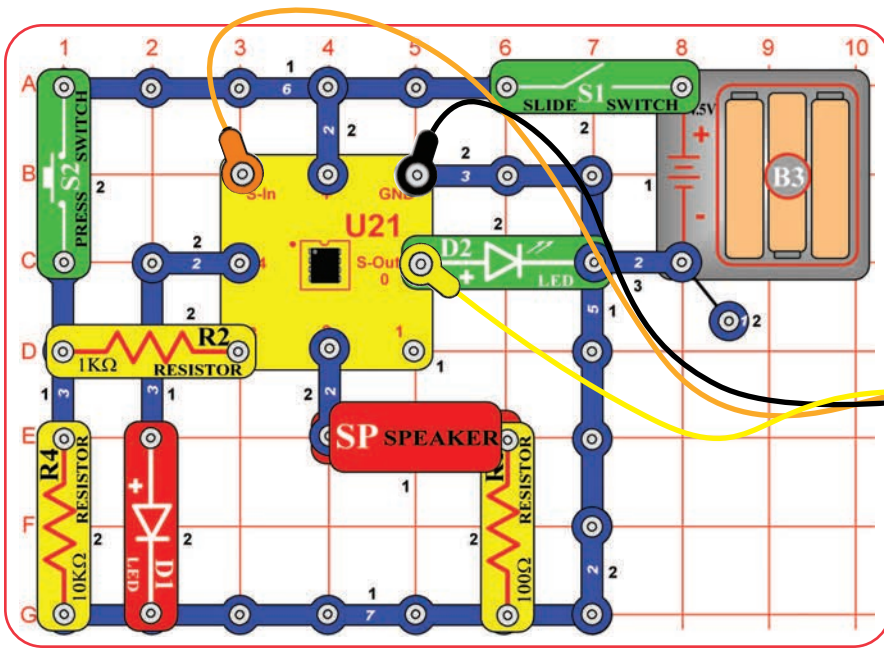

Build the circuit as shown. Turn on the slide switch (S1). Load program Random Sounds or program Random Robotic Sounds into the microcontroller (U21) using the programming instructions in project B1. Push the press switch (S2) and listen to the sounds.

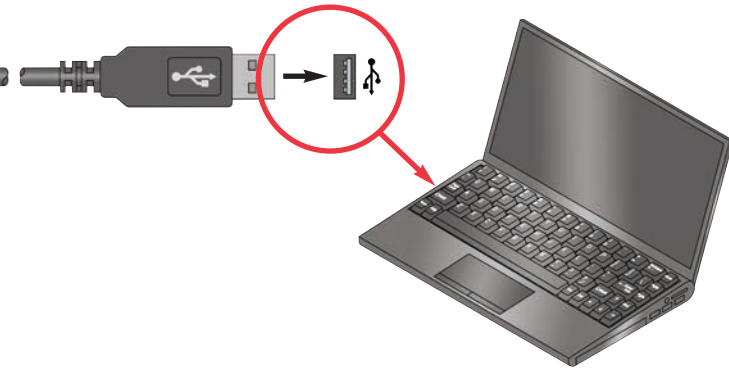

Optional:

```
'Program Random Sounds
main:  random w0
       if pin3=1 then label_7
       goto main
label_7: random w0
        if b0 > 127 then label_7
        sound 2,(b0, 25)
        if b0 < 20 then toggle 0
        endif
        if b0 > 107 then toggle 4
        endif
        goto label_7
```

```
'Program Random Robotic Sounds
main:  random w0
       if pin3=1 then label_7
       goto main
label_7: random w0
        if b0 > 127 then label_18
        let b2=b0
label_1F: if b2 < 60 then label_2A
label_54: let b3=b1
label_49: if b3 > 16 then label_5B
        if b3 < 4 then label_87
label_31: sound 2,(b2,b3)
        pause b1
        goto label_7
```

These programs use the **Random** command to make cute sounds. The random command produces a sequence of numbers that is always the same, but we make the result seem random by changing the start point.

Here the random command is called repeatedly in a loop, while waiting for S2 to be pressed. The number of loops between switch pushes varies, making the result seem random.

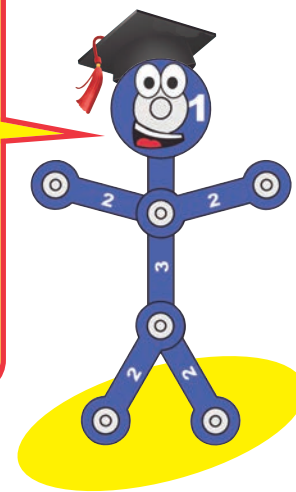



Project B7

Sloppy Switches

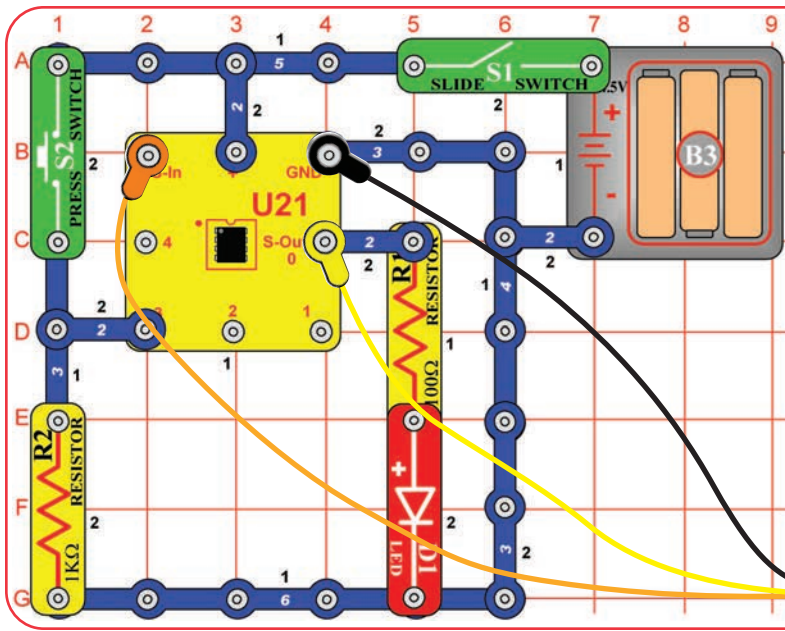

Build the circuit as shown. Turn on the slide switch (S1). Load program Sloppy Switches into the microcontroller (U21) using the programming instructions in project B1.

Push the press switch (S2) several times. Each time you press it the red LED (D1) should toggle (turn on or off). But sometimes it will just flicker and not change. Press the switch enough times to see this happen.

This effect makes it appear the switch isn't working, or the microcontroller isn't watching it carefully enough. Do you know what is really happening?

Most switches use a metal contact that snaps into place. This action may cause the switch to bounce and produce "switch noise" when it is closed. This can cause equipment to think the switch was pressed more than once, and so cause improper operation.

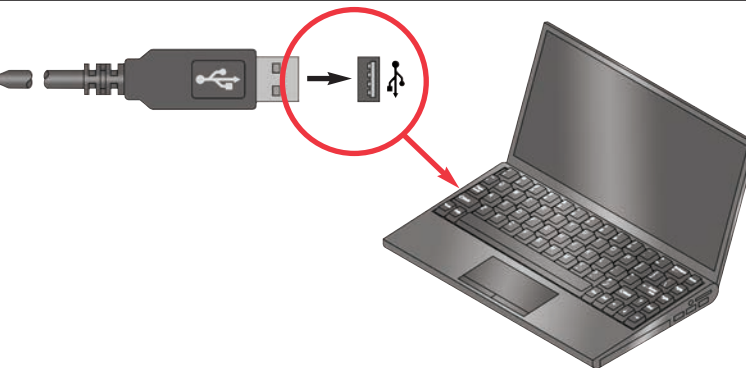

Optional:

'Program Sloppy Switches

main:

```
label_6: if pin3=1 then label_11 'Is switch pressed?
          goto label_6           'Loop until switch pressed.
label_11: toggle 0              'Change LED state
label_18: if pin3=0 then label_6 'Return to start if switch released.
          goto label_18         'Loop until switch released.
```

The program tells the microcontroller to monitor input pin 3, where the press switch is connected. Every time the switch is pressed, the microcontroller is to toggle (turn on or off) the red LED (D1) at output pin 0.

The input pins on the microcontroller have two states - 1 (on, or high, or having strong voltage) or 0 (off, or low, or having no voltage). If the electrical signal is somewhere between these, the microcontroller may get confused.

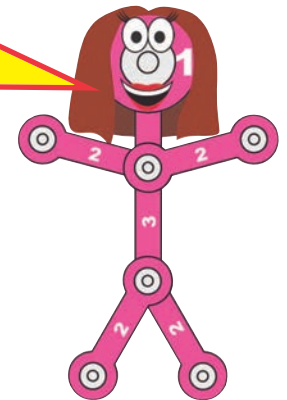



Project B8

Bounceless Switches

Use the same circuit as project B7. Load the program Bounceless Switches into the microcontroller (U21) using the programming instructions in project B1. The circuit works the same, except the LED will toggle every time the switch is pressed. The “switch bounce” problem has been fixed.

Part B. Try swapping the positions of the press switch (S2) and the 1kΩ resistor (R2). Now the red LED changes when the press switch is released instead of when the switch is pushed.

Sometimes hardware cannot be changed but the software (program) can. How could you change the flowchart program to make the LED toggle when the press switch is released using the original circuit? Snappy knows how.

Optional:

'Program Bounceless Switches

main:

```
label_26: pause 100
label_6:  if pin3=1 then label_11
         goto label_6
label_11: toggle 0
label_18: if pin3=0 then label_26
         goto label_18
```

The “switch bounce” problem was fixed here by adding a 0.1 second pause before the microcontroller checks if the switch was pressed.

To make the LED toggle when the press switch is released, change the input pin 3 tests (from 1 to 0 or from 0 to 1).

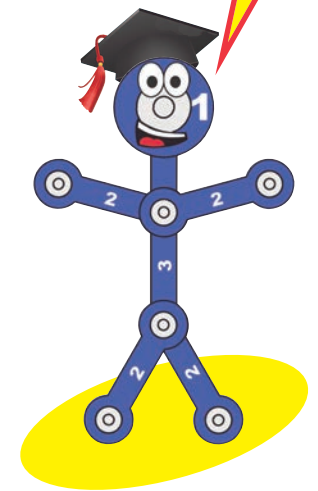

Project B9

Jukebox with Terminal

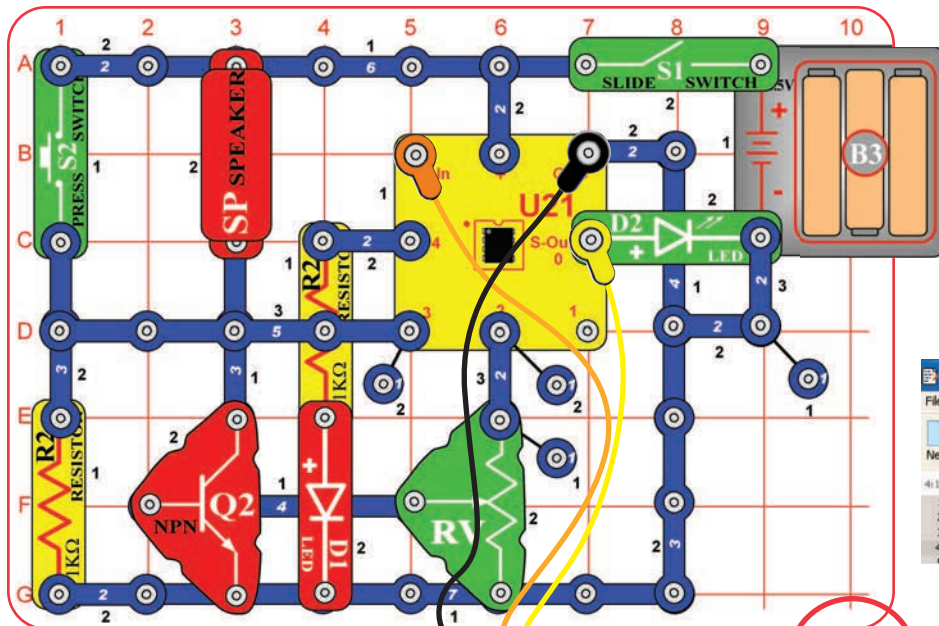

(for download)

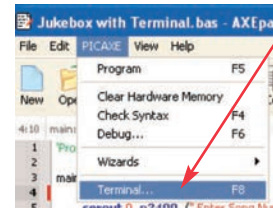

Build the circuit as shown. Turn on the slide switch (S1). Load program Jukebox with Terminal and **modify it as described below**. Load the modified program into the microcontroller (U21) using the programming instructions in project B1.

After program is downloaded, move the orange jumper wire from the S-In snap to the 1 snap, as shown. Press the F8 key or select **Terminal** under the PICAXE menu to open a terminal window for communication with the microcontroller, set the baud rate to **2400**, and select **Refresh**. Turn the slide switch (S1) off and on to reset the microcontroller. Follow the instructions in the terminal **Input Buffer** window to use your "jukebox".

- Song numbers:
- 1 = Happy Birthday
 - 2 = Jingle Bells
 - 3 = Silent Night
 - 4 = Rudolph

(for two-way communication with terminal)

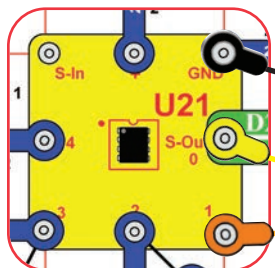

As it is, this program will not work properly. To fix it, modify the program to subtract 49 from variable b2 in line 7, instead of subtracting 1. The serin command in line 6 gives a coded value for variable b2 (called its ASCII code), because you could have typed a letter instead of a number.

Alternatively, you could place case numbers 0-3 in lines 13, 15, 17, and 19 in quotation marks ("0", "1", "2", and "3").

Optional:

Program Jukebox with Terminal

```
main:
  pause 300
  serout 0, n2400, (" Enter Song Number into Output Buffer Window and then click SEND ", 13, 10)
  serin 1, n2400, b2
  let b2 = b2 - 1
  serout 0, n2400, (" Push press switch (S2) to hear Song ", 13, 10)
```

```
label_42: if pin3 = 0 then goto label_42
```

This program uses the **serin** and **serout** commands to send information between the computer screen and the microcontroller. Details on how these commands work can be found under the Help menu at Snap Circuits® XP™.

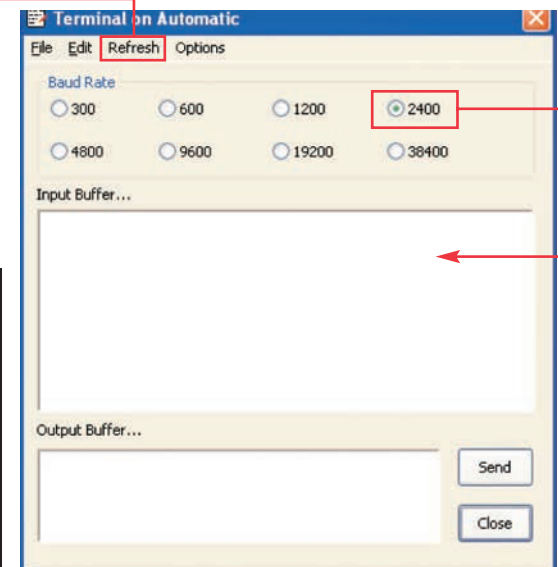



Project B10

(for download)

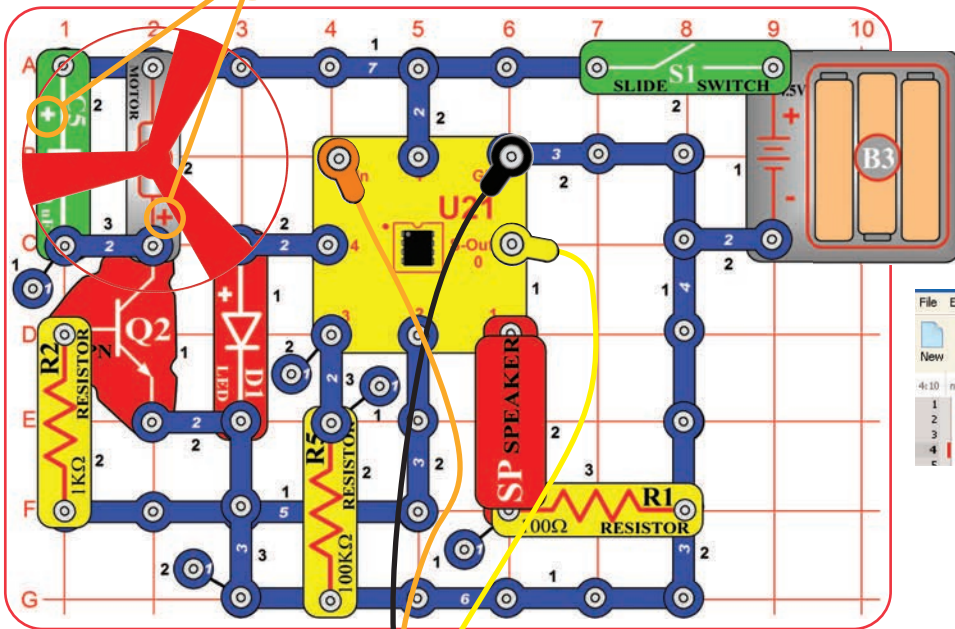

(for two-way communication with terminal)

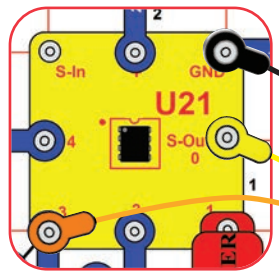

Optional:

```

'Program Launch Pad
main:
  let b4=0
  serout 0, n2400, (" Enter Launch Sequence into Output Buffer Window
label_A:  serin 3, n2400, b0
          if b0=0 then label_A
label_6:  random b0
          if b0 > 127 then label_18
          let b2=b0
label_1F: if b2 < 60 then label_2A
  
```

Your "Launch Sequence" number changes the robotic sounds sequence and adjusts the fan spin time.

WARNING: Moving parts. Do not touch the fan or motor during operation. Do not lean over the motor.

Launch Pad

Build the circuit as shown. Turn on the slide switch (S1). Load program Launch Pad into the microcontroller (U21) using the programming instructions in project B1.

After program is downloaded, move the orange jumper wire from the S-In snap to the 3 snap, as shown. Press the F8 key or select **Terminal** under the PICAXE menu to open a terminal window for communication with the microcontroller, set the baud rate to **2400**, and select **Refresh**. Turn the slide switch (S1) off and on to reset the microcontroller.

Enter any number (your "Launch Sequence") in the terminal **Output Buffer** window. Robotic sounds are played and the fan spins (and often flies). Reset the fan on the motor and enter another launch sequence.

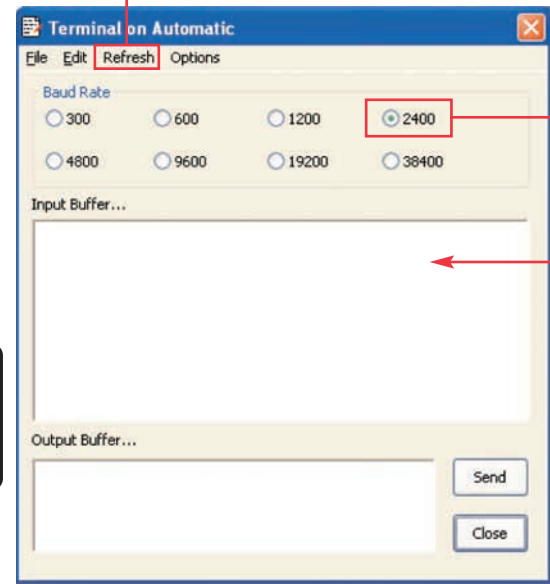
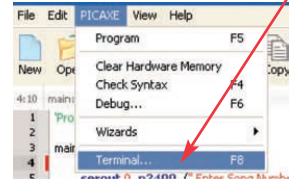



Project B11

Adjustable Blinker

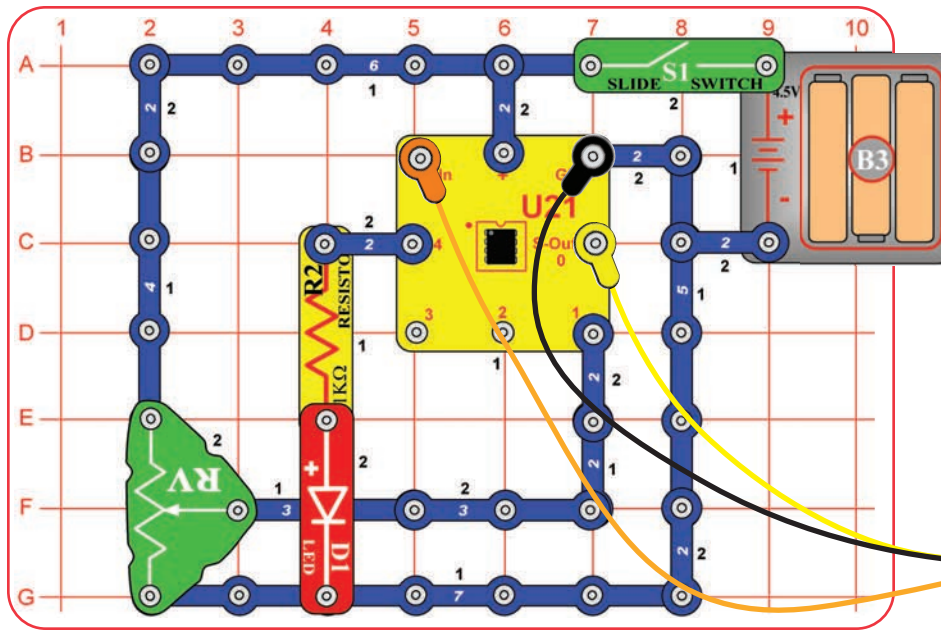

Build the circuit as shown. Turn on the slide switch (S1). Load program Adjustable Blinker into the microcontroller (U21) using the programming instructions in project B1. The red LED (D1) will be blinking. Adjust the lever on the adjustable resistor (RV) to adjust the blink rate.

At some RV settings, the red LED may be blinking so fast that it appears to stay on continuously. The reason is that your eyes cannot adjust fast enough. They continue to see what they have just seen.

This concept is used in movie theaters, where film frames are flashed on the screen at a fast rate. Your eyes see this fast series of flashes as a continuous movie.

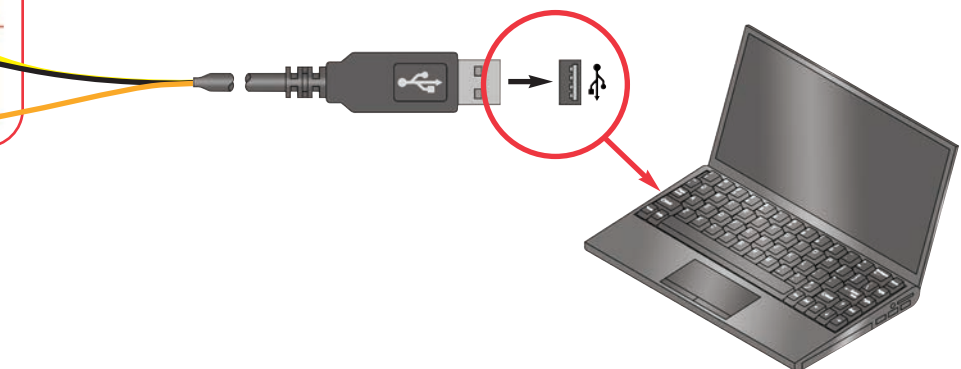

Optional:

Program Adjustable Blinker
main:

```
readadc10 1, w0
high 4
pause w0
low 4
pause w0
goto main
```

This program tells the microcontroller to measure the voltage at input pin 1, then use that value to adjust the delay in turning output 4 on and off. The red LED is connected to output 4, so it will blink. The adjustable resistor sets the voltage to input 1.

The **Readadc10** command configures pin 1 to be an analog-to-digital converter (ADC) input, and measures the voltage there. The voltage (analog, an electrical signal) is converted to digital (a number), so it can be stored in the microcontroller's memory. The measured number will be from 0 to 1023, due to 10-bit measurement accuracy. More details on how this command works can be found under the Help menu at Snap Circuits® XP™.

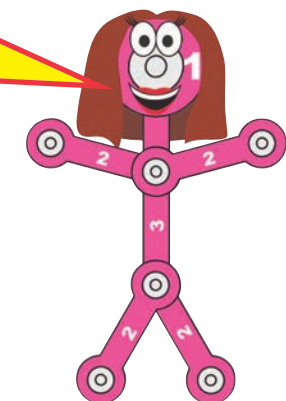



Project B12

Basic Light Meter

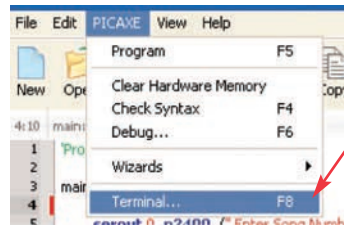
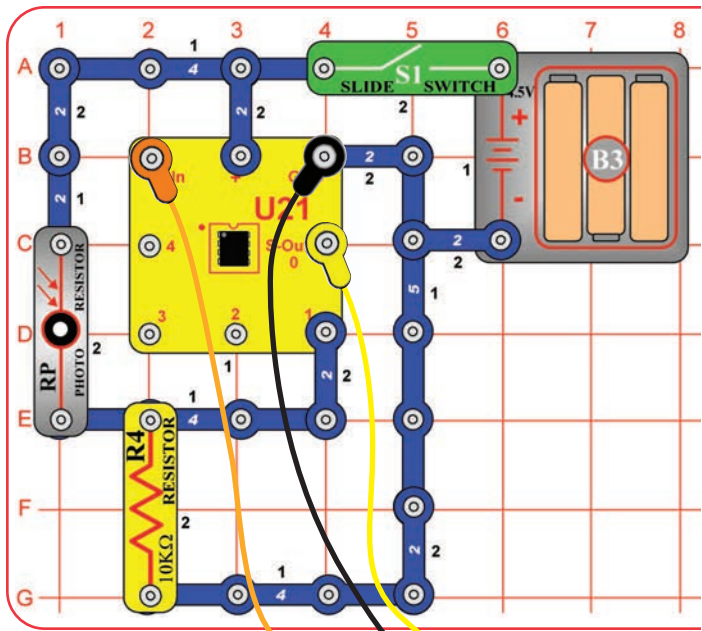

Build the circuit as shown. Turn on the slide switch (S1). Load program Basic Light Meter into the microcontroller (U21) using the programming instructions in project B1.

Press the F8 key or select **Terminal** under the PICAXE menu to open a terminal window for communication with the microcontroller, set the baud rate to **4800**, and select **Refresh**. Turn the slide switch (S1) off and on to reset the microcontroller.

The microcontroller measures the amount of light on the photoresistor (RP), then displays it as a number in the Terminal (0 is total darkness, 255 is brightest).

You can shift the brightness scale by replacing the 10kΩ resistor (R4) with one of the other resistors.

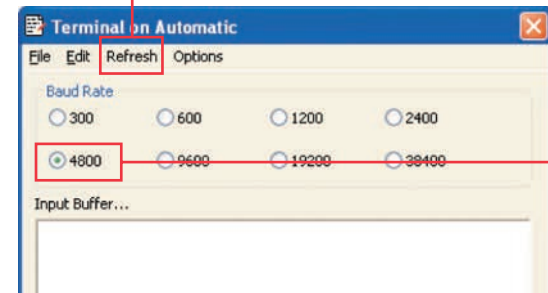
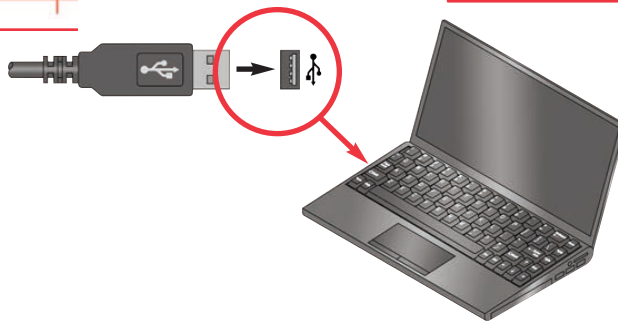

Optional:

'Program Basic Light Meter

main:

```
readadc 1,b0
sertxd (#b0,13,10)
pause 500
goto main
```

Changing the amount of light shining on the photoresistor changes its resistance, and so changes the voltage measured at the ADC microcontroller input (the **readadc** command). The readadc command has 8-bit accuracy, so the measured number will be from 0 to 255. The **sertxd** command displays the measurement in the terminal.

The 10kΩ resistor (R4) allows the voltage at the ADC microcontroller input to fall when it is dark and rise when there is light on the

photoresistor. The voltage measured depends on the ratio of the photoresistor resistance to the 10kΩ resistor (R4). The measured value will be about 128 when the photoresistor resistance equals R4. Replacing R4 with another resistor shifts the measured light value (between 0 and 255).

More details on how these commands work can be found under the Help menu at Snap Circuits® XP™.

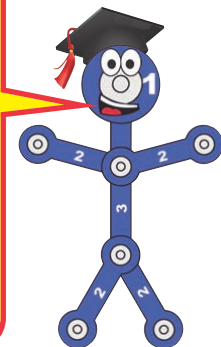



Project B13

Capacitor Discharge

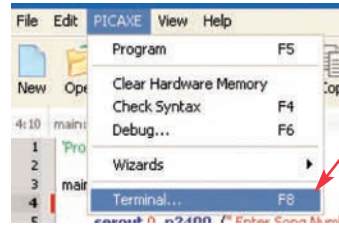
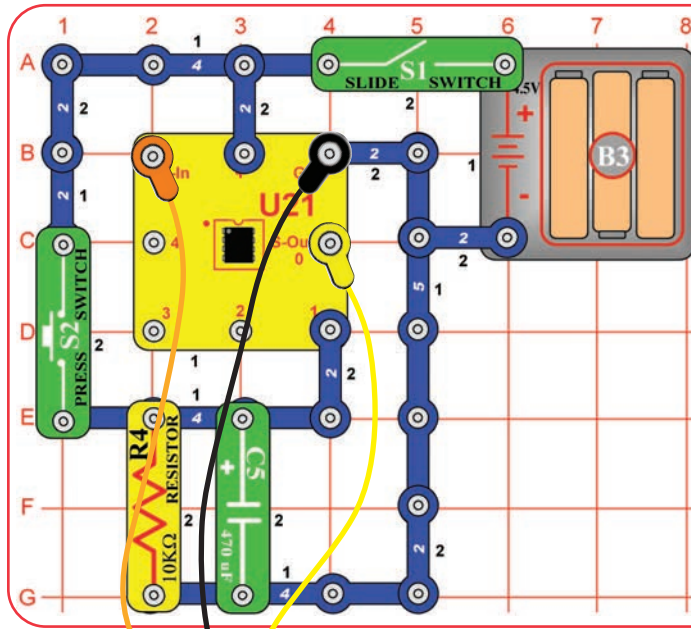

Build the circuit as shown. Turn on the slide switch (S1). Load program Basic Light Meter into the microcontroller (U21) using the programming instructions in project B1, unless you already loaded it in the preceding project.

Press the F8 key or select **Terminal** under the PICAXE menu to open a terminal window for communication with the microcontroller, set the baud rate to **4800**, and select **Refresh**. Turn the slide switch (S1) off and on to reset the microcontroller.

Push the press switch (S2) to charge the 470µF capacitor (C5). The microcontroller measures the voltage at the capacitor, then displays it as a number in the Terminal. When the capacitor is fully charged then 255 will be displayed, when it is fully discharged then 0 will be displayed. You can study how quickly the capacitor discharges.

Change the capacitor discharge rate by replacing the 10kΩ resistor with any of the other resistors (including the photoresistor). You can also swap the positions of the press switch and resistor.



Optional:

'Program Basic Light Meter
main:

```
readadc 1,b0
sertxd (#b0,13,10)
pause 500
goto main
```

If you remove the resistor completely from the circuit, the capacitor will still discharge but very slowly. This is due to the resistance of the microcontroller input, which is very high.

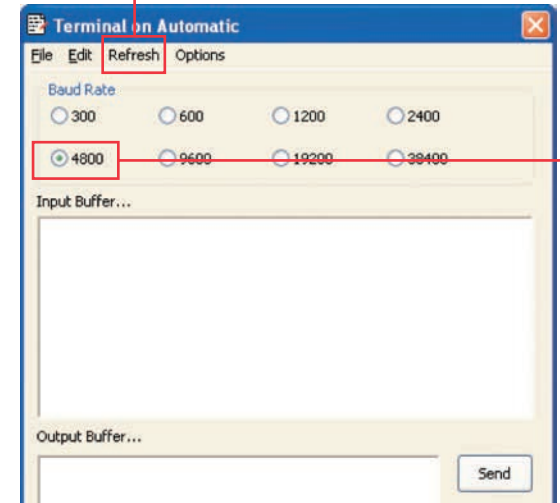
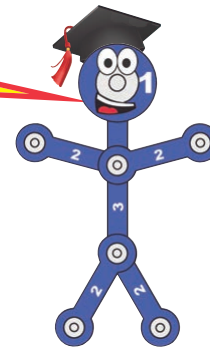

Project B14 Sunrise Alarm

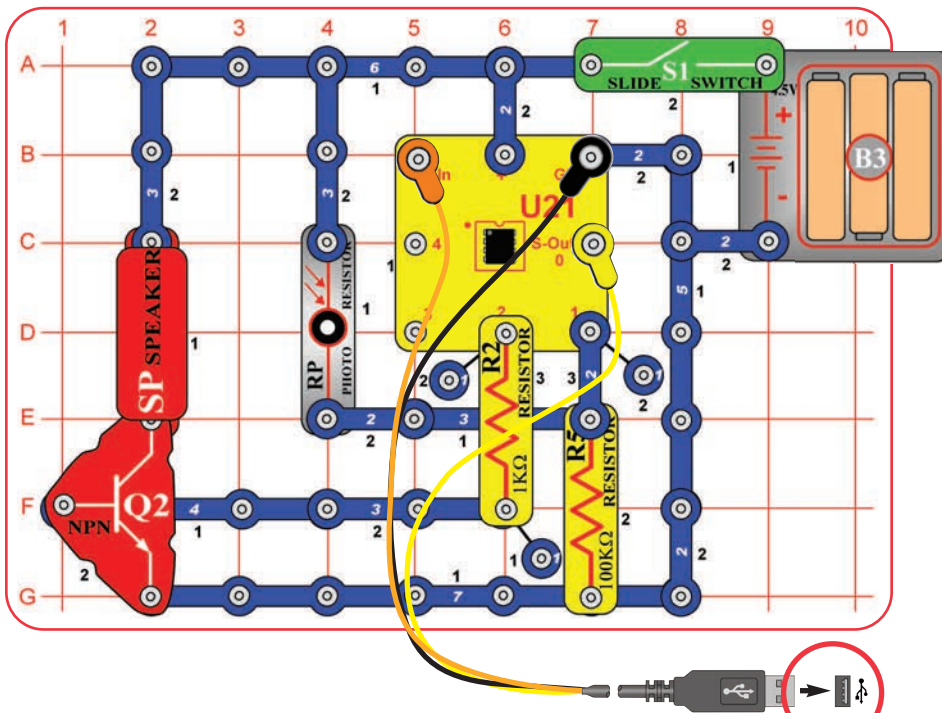

Build the circuit as shown. Turn on the slide switch (S1). Load program Sunrise Alarm into the microcontroller (U21) using the programming instructions in project B1.

The microcontroller measures the amount of light on the photoresistor (RP). If there is light in the room, a song is played every 30 seconds.

You can turn on this circuit when you go to bed at night. When sunrise lights up the room in the morning, the alarm sounds to wake you up. The programming cable may be removed once the program is downloaded.

Optional:

'Program Sunrise Alarm

main:

```
readadc 1,b0
if b0 < 80 then
  goto main
endif
```

'Read voltage through
'If too dark do not play song

```
tune 2, 4, ($25,$29,$00,$05,$42,$44,$45,$42,$00,$2A,$02,$29,$00,$27,$04,$C5)
pause 30000
goto main
```

'Wait 30 seconds before playing song again
'Repeat process

The **if** command decides whether there is enough light to play the alarm.

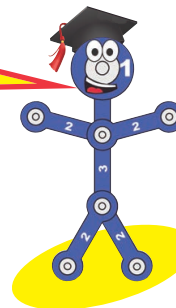

Project B15 Photon Counter

Use the same circuit as project B14. Load the program Photon Counter into the microcontroller (U21) using the programming instructions in project B1. The circuit makes a high pitch sound depending on how much light shines on the photoresistor (RP). The sound is like a Geiger Counter.

Optional:

'Program Photon Counter

main:

```
readadc 1,b0
b0=255-b0
sound 2,(125,1)
pause b0
goto main
```

'Get light reading
'Invert reading
'Play high pitch click sound
'Pause between clicks indicates level
'Repeat process

By changing the program in the microcontroller, we can make the same circuit work a lot differently.

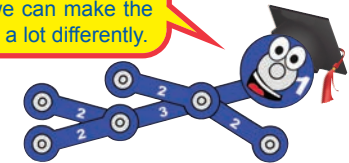

Project B16 Photon Kazoo

Use the same circuit as projects B14 & B15, but load the program Photon Kazoo into the microcontroller (U21). Place your finger just above the photoresistor (RP) and move it around to change the sound. You can control the pitch of the sound with your finger. It is like an electronic kazoo.

Optional:

'Program Photon Kazoo

main:

```
readadc 1,b0
b0=255-b0
if b0 < 20 then
  b0=0
endif
sound 2,(b0,1)
goto main
```

'Read photoresistor
'Invert reading
'If too low make silent
'If in range play sound
'Repeat process



Project B17

Click Counter

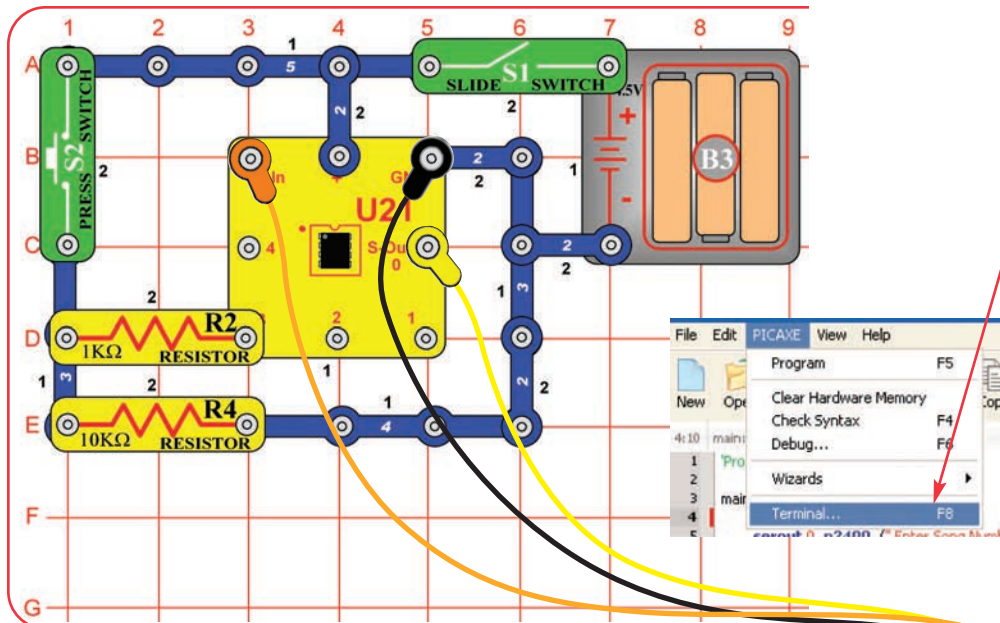

Build the circuit as shown. Turn on the slide switch (S1). Load program Click Counter into the microcontroller (U21) using the programming instructions in project B1.

Press the F8 key or select **Terminal** under the PICAXE menu to open a terminal window for communication with the microcontroller, set the baud rate to **4800**, and select **Refresh**. Turn the slide switch (S1) off and on to reset the microcontroller.

Push the press switch (S2) as many times as you like. The program keeps count.

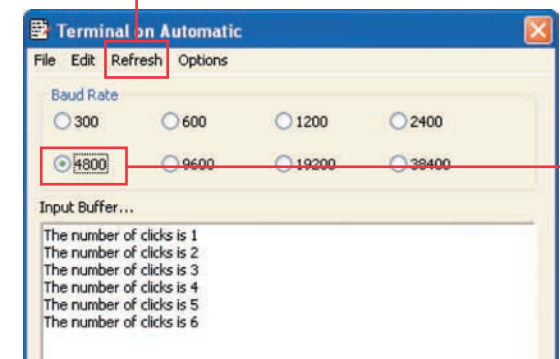

Optional:

```

Program Click Counter
  let b0=0
main:
  if pin3=1 then label_11      'Is switch pressed?
  goto main                  'Loop until switch pressed.
label_11:
  pause 50
  if pin3=1 then goto label_11: 'Loop until switch released.
  inc b0                      'Add 1 to count
  if b0 = 0 then              'If limit is reached tell clicker starting over
  sertxd("I am tired and starting over at ",#b0,13,10) 'Send message
  endif
  sertxd("The number of clicks is ",#b0,13,10) 'Otherwise display number of clicks
  goto main                  'Start over

```

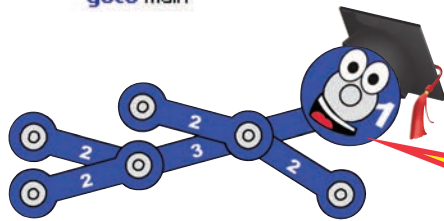

The memory location where the click count is stored can hold a number up to 255. If the count gets higher, it overflows and goes to 0.

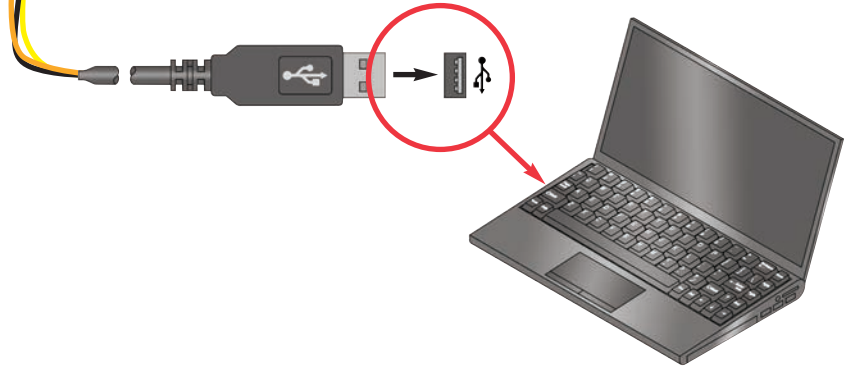

Project B18

Super Click Counter

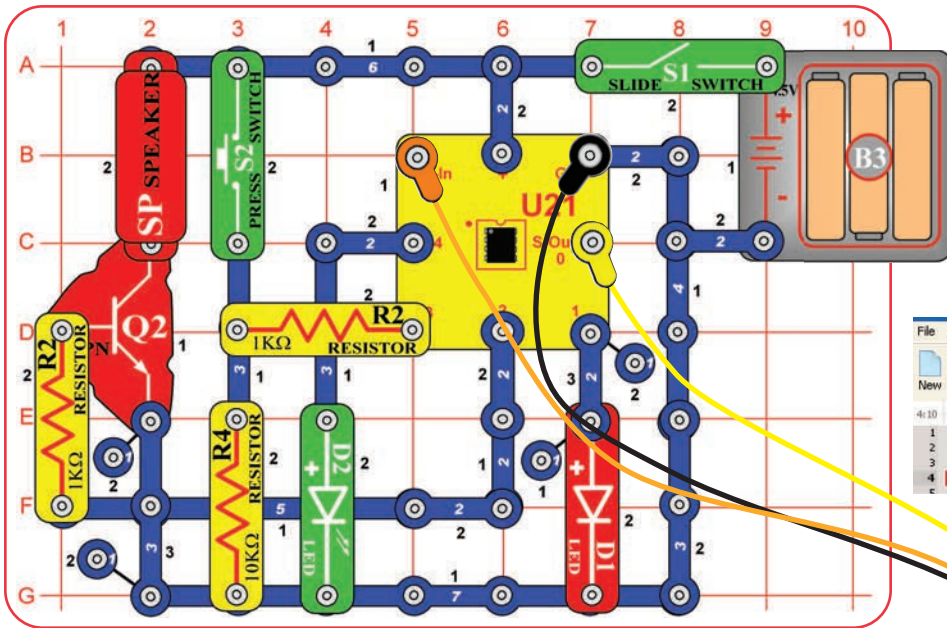

Build the circuit as shown. Turn on the slide switch (S1). Load program Super Click Counter into the microcontroller (U21) using the programming instructions in project B1.

Press the F8 key or select **Terminal** under the PICAXE menu to open a terminal window for communication with the microcontroller, set the baud rate to **4800**, and select **Refresh**. Turn the slide switch (S1) off and on to reset the microcontroller.

Push the press switch (S2) as many times as you like. The program keeps count, and things happen as the count increases.

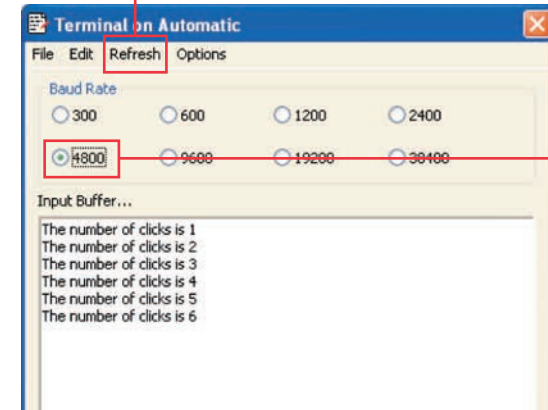
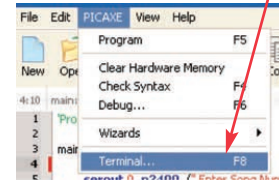

Optional:

```
'Program Super Click Counter
let b0=0
main:
  if pin3=1 then label_11      'Is switch press
  goto main                  'Loop until switc
label_11:
  pause 30
  if pin3=1 then goto label_11: 'Loop until switc
  inc b0                      'Add 1 to count
  if b0 = 0 then              'If limit is reach
    sertxd("I am tired and starting over at ",#b0,13,10) 's
  endif
  sertxd("The number of clicks is ",#b0,13,10) 'Other
  if b0=15 then high 1
  endif
  if b0=45 then low 1
  endif
  if b0=125 then high 1
  endif
  if b0=200 then low 1
  endif
```

You can change when the LEDs go on and off.

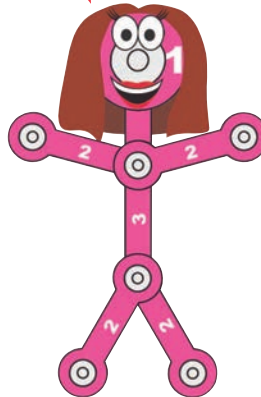



Project B19

Data Logger

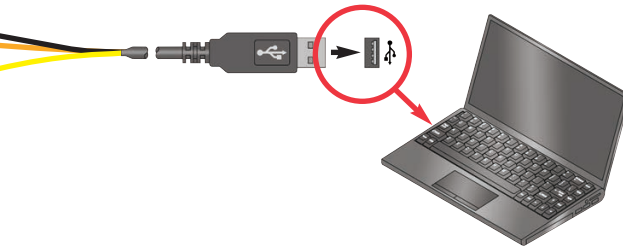
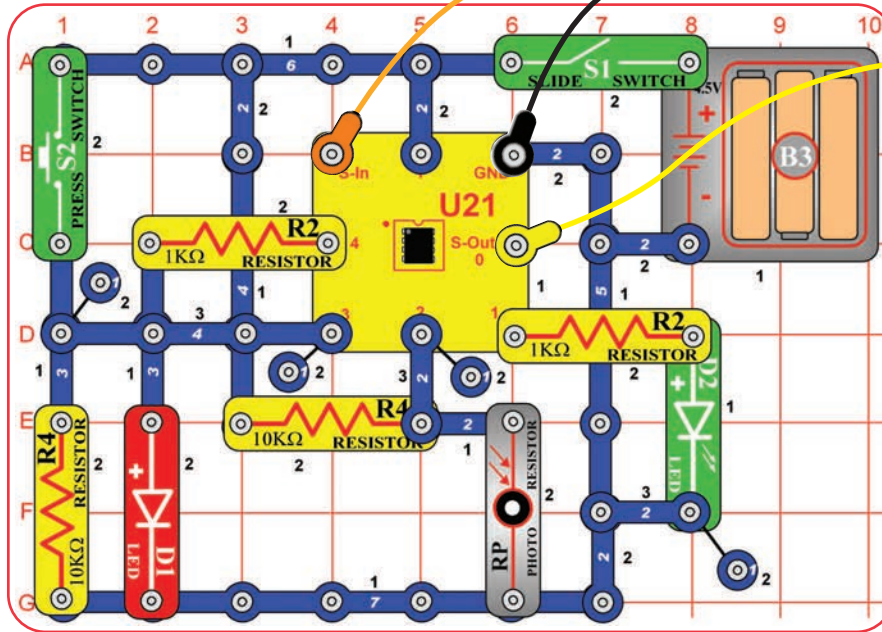

A data logger stores data, usually for later download to a computer. Build the circuit as shown. Turn on the slide switch (S1). Load program Data Logger into the micro-controller (U21) using the programming instructions in project B1.

The microcontroller measures the amount of light on the photoresistor (RP), making a measurement every 6 seconds. Every 15 minutes an average is taken and stored so it can be accessed later. Data can be taken for 6 hours.

To access the data, reconnect the programming cable, press the F8 key or select **Terminal** under the PICAXE menu to open a terminal window for communication with the microcontroller, set the baud rate to **2400**, and select **Refresh** to clear terminal screen.

Press the press switch (S2) and release it within 0.5 seconds to “dump” the data to the terminal window. When memory is full, approximately 6 hours of data, both lights will flash. The microcontroller will retain the data even if the slide switch is turned off; to reset the program and remove the data you must reload the program into the microcontroller.

After reprogramming, you can set the circuit under a lamp, measure the light over 6 hours, then reconnect the programming cable to access it (open a terminal and press S2). The circuit may be turned off and reconnected to the computer for data dumps before the memory is full. You can find out how the room brightness varies throughout the 6 hour period. Data is stored in 15 minute intervals and is recorded as minutes.

Optional:

```

Program Data Logger
main:
  setint 8, 8
  read 48, b13
  if b13 > 46 then label_full

abel_55:
  for b0 = 1 to 15
  for b1 = 1 to 10
  pause 5994
  readadc 2, b2
  if b2 < 120 then
    inc w4
    toggle 4
    low 1
  else
    toggle 1
    low 4
  endif
  write b13, word w4
  next b1
  next b0
  let b13=b13+2
  write 48, b13
  if b13 > 46 then label_full

abel_A7:
  w4=0
  goto label_55

abel_full:
  pause 500
  toggle 4, 1
  goto label_full
  
```

The data is stored in the same memory area as the main program with the write command, and retrieved by using a subroutine and the read command. When the press switch is pressed an interrupt stops the main program to execute the subroutine to retrieve the data stored thus far and send it to the terminal window. More details on how these commands work can be found under the Help menu at Snap Circuits® XP™.

This line sets the delay between stored recordings to 15 minutes. Try changing this number to 5. This will change the delay between recordings to every 5 minutes and allow only 2 hours of data to be gathered, every 5 minutes.

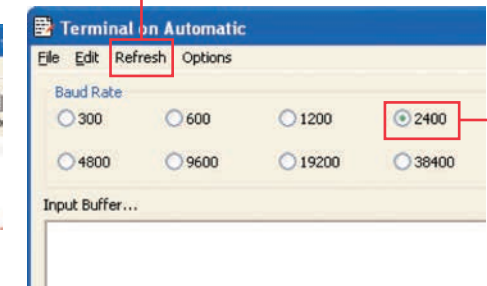
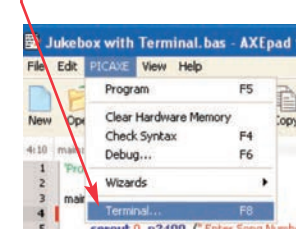



Project B20

Data Logger with Cost

This program uses the previous circuit, but adds wattage for the light being measured, cost per kilowatt hour, and total cost calculations to the data output. Use the same circuit, and turn on the slide switch (S1). Load the program "Data Logger with Cost" into the microcontroller U21 using instructions in project B1.

The microcontroller measures the time a 100 watt light bulb is on using photoresistor (RP) at start up and for the next 6 hours. During this process the microcontroller calculates the cost based on

12.5 cents per kilowatt hour. Data is sent to the microcontroller as it is taken and stored every six seconds in a data memory location. Every 15 minutes a new location is created and this process continues for 24 locations or 6 hours. When 24 locations are filled the LEDs flash to indicate memory is full. Data logger with cost may be stopped and restarted but data for the recorded location may be lost.

Access the data using the terminal window as described in the preceding Data Logger project.

Optional:

```

label_full:
  pause 500           'Wait .5 seconds
  toggle 4, 1        'Change both LEDs
  goto label_full    'Repeat flashing
interrupt:
  b3 = 0             'Initialize counters
  w5 = 0
  do
    read b3, word w3 'Get data
    w5 = w5 + w3     'Add minutes for total minutes
    w2 = w3//10     'Get decimal part of minutes
    w3 = w3/10     'Get whole part of minutes
    serout 0,N2400,(#w3,".",#w2," ") 'Send data to terminal
    b3 = b3 + 2     'Go to next memory point
  loop while b3 < b13
  w2 = w5//10     'Loop until end of data
  w3 = w5/10     'Get decimal of total minutes
  serout 0,N2400,(13,"t=",#w3,".",#w2) 'Display total minutes
  w5 = w5/60     'Get whole part of total minutes
  w5 = w5*125    'Change minutes to hours
  w2 = 10000/100 'Multiply by rate/kwh times 10 (12.5 cents shown here)
  w3 = w5/w2     'Divide by wattage (range = 10 to 1000 , 100 shown)
  w2 = w3//10    'Get cost for watts number
  w3 = w3/10    'Get fractional part
  serout 0,N2400,(13,"$=",#w3,".",#w2," cents",13) 'Display cost
  pause 500     'Get whole number part
  setint 8, 8   'Wait for .5 seconds
  return       'Reset interrupt
              'Return to counting from point at interrupt

```

This number sets the cost in pennies times 10 per kilowatt hour. 12.5 cents = 125.

This number sets the wattage for the lamp being measured. Range is 10 to 1000 watts.

This line calculates the fractional penny cost for the time period displayed.

This line calculates the whole penny cost for the time period displayed.

This line displays total cost (in cents) during a data dump.

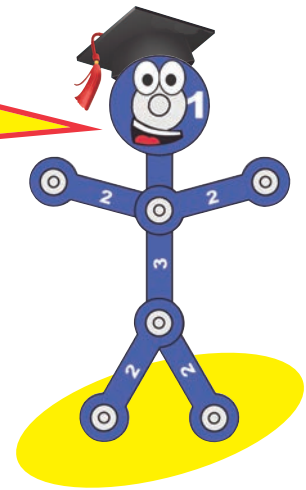



Project B21

24 Hour Data Logger

This circuit is a data logger, which calculates the cost of electricity used by a lamp or other light source in one day. You will be able to modify the program to test it with a short time period, then restore it to the original program to measure the energy cost over a full day. Use the circuit from project B19 (Data Logger). Turn on the slide switch (S1). Load the program “Data Logger 24 Hour” into the microcontroller (U21) using instructions in project B1. Turn switch S1 off immediately after download.

The microcontroller measures the amount of light on the photoresistor (RP), at start and every hour for 24 hours. Data is stored and sent to the computer every 6 seconds, but can also be accessed at any time. Place the circuit near a lamp or other electric light. Point the photoresistor at the source to be measured and shield

it from daylight and other light sources. Turn on S1 and test circuit. The red LED should be on for 6 seconds then off for 6 seconds when the source is on. The green LED will be on for 6 seconds then off for 6 seconds when the source is off. If ambient light interferes try using a tube from a roll of toilet paper to shield the photoresistor (RP) from other light sources. Data can be taken for 24 hours. When memory is full both LEDs will blink.

You may turn off the data logger (S1) and reconnect it to your computer at any time to inspect data gathered thus far, but time from that hour may be lost. Access the data using the terminal window as described in the Data Logger project.

Point the photoresistor at a lamp and shield it from other light sources.

Optional:

'Program Data Logger 24 Hour

main:

```
setint 8, 8
read 48, b13
if b13 > 46 then label_full
```

label_55:

```
for b0 = 1 to 60
for b1 = 1 to 10
pause 5994
readadc 2, b2
if b2 < 120 then
inc w4
toggle 4
low 1
else
toggle 1
low 4
endif
write b13, word w4
next b1
next b0
let b13=b13+2
write 48, b13
```

```
'Set interrupt to read data when button pushed
'Get data last stored area
'If 6 hours are stored goto full data
```

```
'60 minute counter = 1 hour
'Flashes light and records data every 6 seconds
'Make 5994 = 1 for testing
'Read light level
'Check for light
'Increment the 6 second counter
'Toggle red LED
'Make sure green LED is off
'If no light
'Toggle green LED
'Make sure red LED is off
'End of light check
'Store data gathered thus far
'Next 6 second period
'Next minute
'Set next memory location
'Save record number
```

In the previous project you were shown how to change wattage and electric cost rate to make the data logger match your situation.

This line sets the period of time being stored. Note how it is 60 minutes for recording each hour. Since the memory holds 24 recordings, the memory will hold one day of data.

Testing at high speed can be accomplished by changing this number from 5994 to 1. Download and test by placing finger over (RP) to change from on to off. Remember to restore this value to 5994 and download again for 24 hour use.

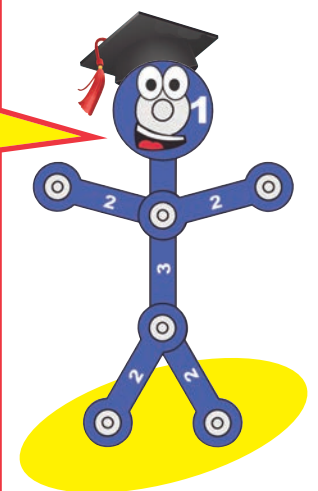



Project B22

Digital Voltmeter

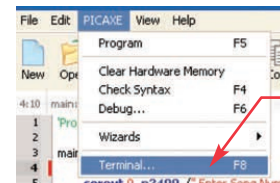
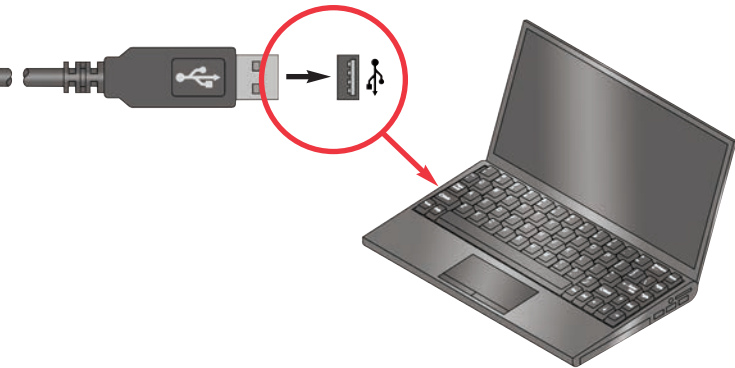
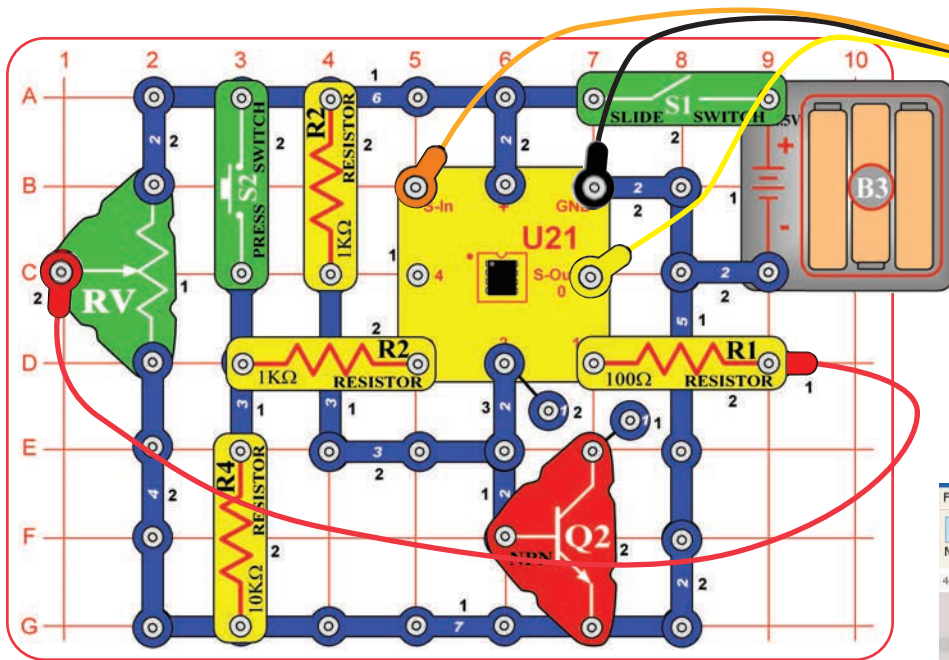

Build the circuit as shown. Turn on the slide switch (S1). Load program Digital Voltmeter into the microcontroller (U21) using the programming instructions in project B1. Press the F8 key or select **Terminal** under the PICAXE menu to open a terminal window for communication with the microcontroller, set the baud rate to **2400**, and select **Refresh**.

The microcontroller will measure the voltage at input 1, which is set using the adjustable resistor (RV). Set the lever on RV to any position, then push the press switch (S2) to measure and display the voltage. Setting the RV lever to the top position will measure the voltage from your batteries (B3).

Optional:

```

'Program Digital Voltmeter
main:
  let w6 = 80
  calibrate:
    readadc10 2, w5
    w2=w5*60/w6
    if w2 = 76 then VM
    inc w6
    goto calibrate
  VM:
    readadc10 1, w1
    w2=w1*60/w6
    w3=w2/100
    w4=w2//100
    serout 0, N2400, (#w3, ".", #w4, " Volts", 13, 1C
  nopush:
    if pin3=1 then yespush
    goto nopush
  yespush:
    if pin3=0 then VM
    goto yespush
  
```

This circuit uses part of the NPN transistor (Q2) as a reference, to calibrate the ADC in the microcontroller for correct voltage measurements. This self-calibration eliminates the error that would occur as the batteries discharge, but your measurements will still have some error. The adjustable resistor (RV) sets the voltage to be measured, which will be between 0V and the battery voltage.

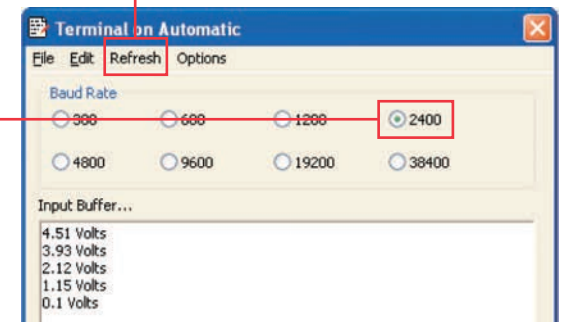
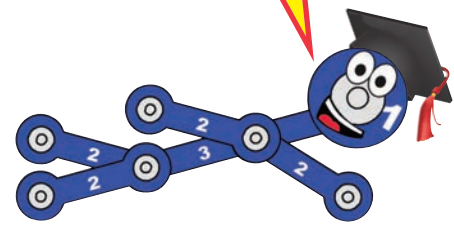



Project B23

Battery Tester (4V or less)

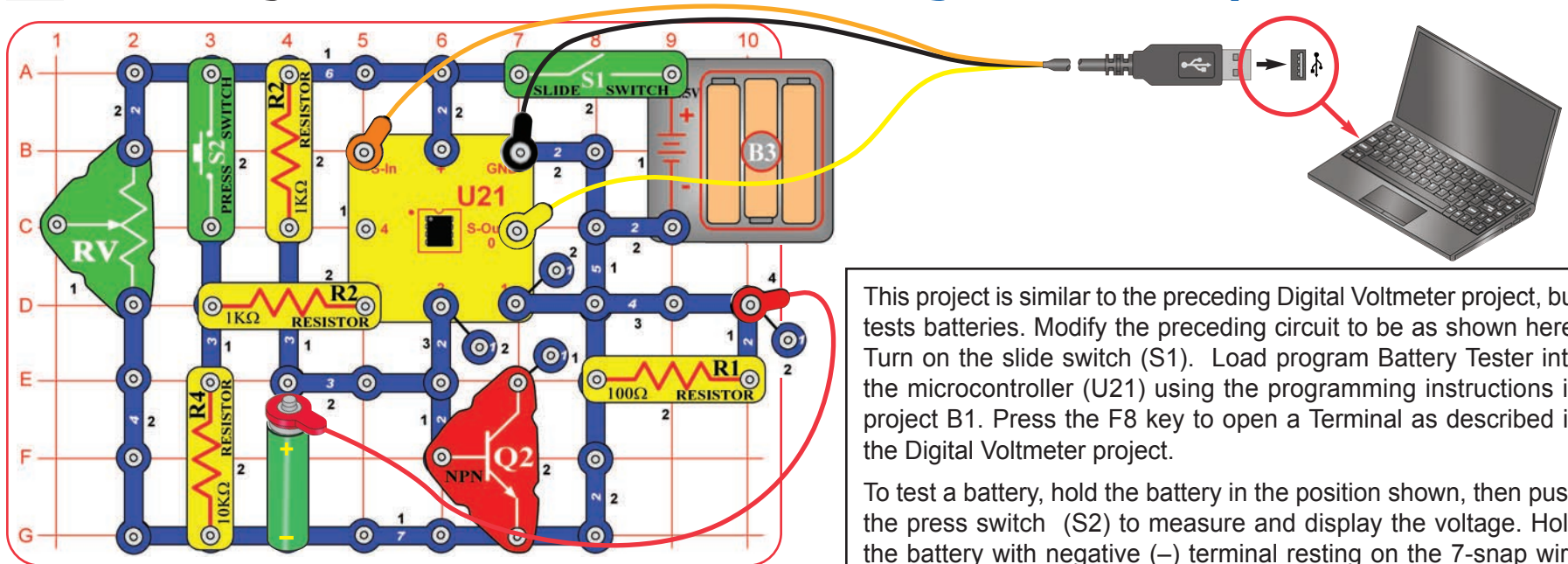

This project is similar to the preceding Digital Voltmeter project, but tests batteries. Modify the preceding circuit to be as shown here. Turn on the slide switch (S1). Load program Battery Tester into the microcontroller (U21) using the programming instructions in project B1. Press the F8 key to open a Terminal as described in the Digital Voltmeter project.

To test a battery, hold the battery in the position shown, then push the press switch (S2) to measure and display the voltage. Hold the battery with negative (-) terminal resting on the 7-snap wire and the positive (+) terminal touching the end of the red jumper wire. If measurement is 0.0V or 0.1V, then you are not making proper contact with the battery terminals, or have the battery upside down. For 1.5V batteries, if measurement is 1.0V or less, then the battery is dead and no longer useful. Batteries up to 4.0V can be measured.

Part B: This circuit uses the 100Ω resistor (R1) as a “load”, to make sure the battery works properly when current is being drawn from it. Remove R1 from the circuit and re-test some batteries. The measured voltage may be higher now; the difference will be slight for batteries that are new or of high quality, and higher for batteries that are older or of lower quality. You can use this test to compare different battery brands.

You can also replace R1 with the motor (“+” on right) and fan. This makes the “load” heavier, and the measured voltage for a battery will be lower.

Optional:

```

'Program Battery Tester
main:
  let w6 = 80
  calibrate:
    readadc10 2, w5
    w2=w5*60/w6
    if w2 = 76 then VM
    inc w6
    goto calibrate
VM:
  readadc10 1, w1
  w2=w1*60/w6

  w3=w2/100
  w4=w2//100
  serout 0, N2400, (#w3, ".", #w4, "
nopush:
  if pin3=1 then yespush
  goto nopush
yespush:
  if pin3=0 then VM
  
```

A battery make electricity using a chemical reaction, but has a limited amount of chemicals and not all of it can react at the same time. When a battery cannot supply as much current as a circuit needs, the voltage (electrical pressure) drops.

Engineers refer to this as putting a load on a battery, because it is the burden the battery is carrying.

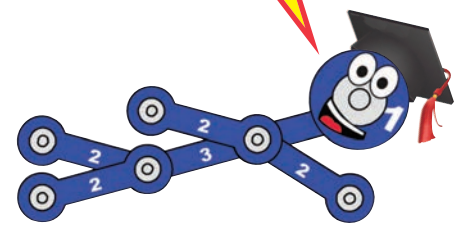

WARNING: Moving parts. Do not touch the fan or motor during operation. Do not lean over the motor.

Project B24 Battery Tester (20V or less)

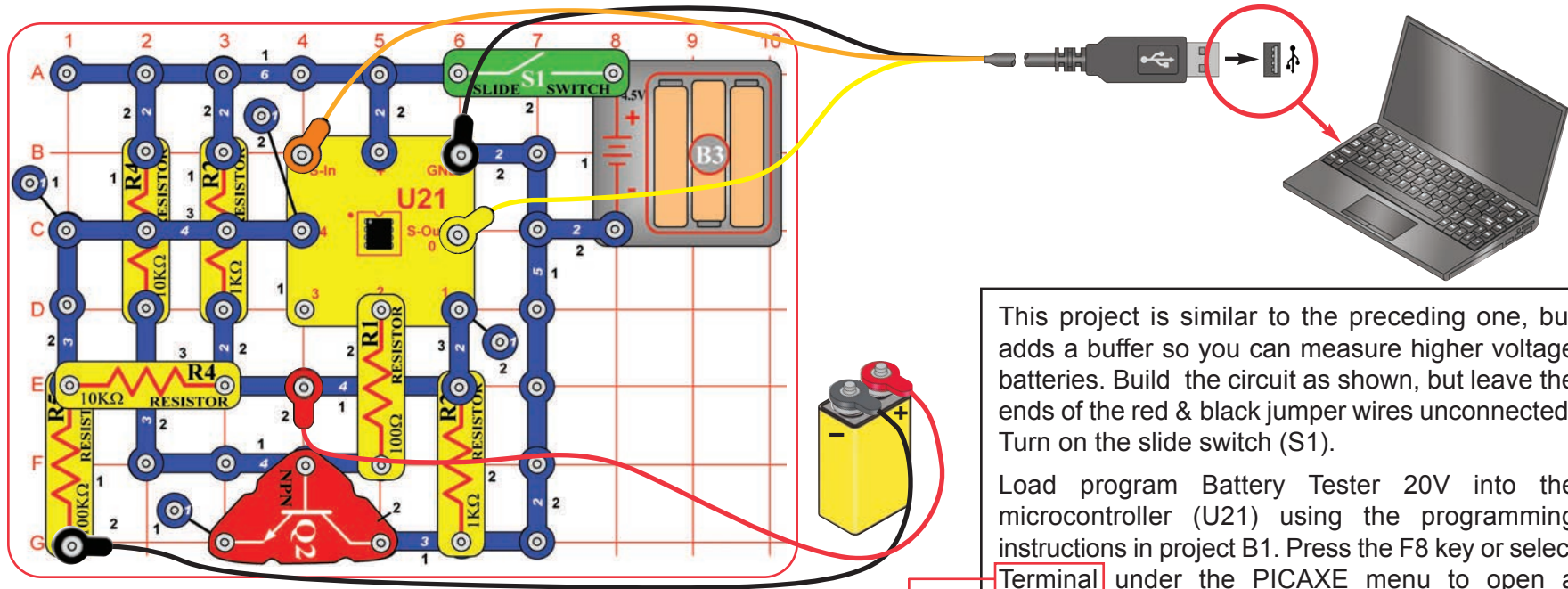

This project is similar to the preceding one, but adds a buffer so you can measure higher voltage batteries. Build the circuit as shown, but leave the ends of the red & black jumper wires unconnected. Turn on the slide switch (S1).

Load program Battery Tester 20V into the microcontroller (U21) using the programming instructions in project B1. Press the F8 key or select **Terminal** under the PICAXE menu to open a terminal window for communication with the microcontroller, set the baud rate to **4800**, and select **Refresh**. Voltage measurements will be displayed in the Terminal.

To test a battery, hold the loose ends of the red & black jumper wires to the terminals of the battery, as shown. If measurement is negative then reverse your connection to the battery terminals. If measurement is 0.0V or 0.1V, then you are not making proper contact with the battery terminals.

Optional:

'Program Battery Tester 20V

```

main:
  let w6 = 80
calibrate:
  readadc10 2, w5
  pause 50
  w2=w5*60/w6
  if w2 = 70 then VM
  inc w6
  goto calibrate
VM:
  let b6 = 0
  let b7 = 0
  let w2 = 0
  let w5 = 0
VM1:
  readadc10 4, w0
  pause 10
  readadc10 1, w1
  pause 10
  if w1 < w0 then VNeg
  inc b7
  w2=w1-w0*67/w6+w2
  if b7 = 10 then
  b7=w2/100
  
```

'Starting point for
'Read the referen
'Calculate referer
'If wrong goto ne
'Increase the ref
'Try again
'Reset number of negative reading
'Reset number of positive reading:
'Reset positive reading sum
'Reset negative reading sum
'Get zero volt reference (approx.
'Read the input voltage
'If input voltage is less than zero
'Calculate for decimal readout
'Get the digit before the decimal p

This circuit uses resistors to reduce the voltage measured, so that it will be within the measurement range of the ADC in the microcontroller. It will be a little less accurate than the Digital Voltmeter project.

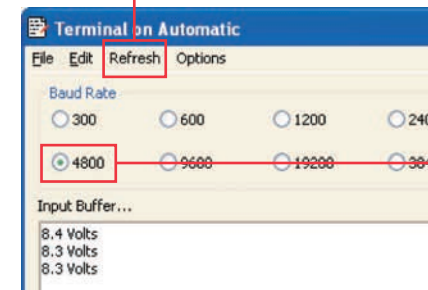
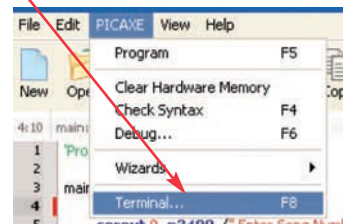
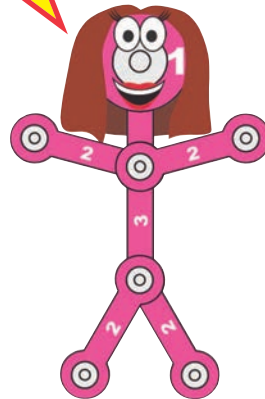



Project B25

Clap Light

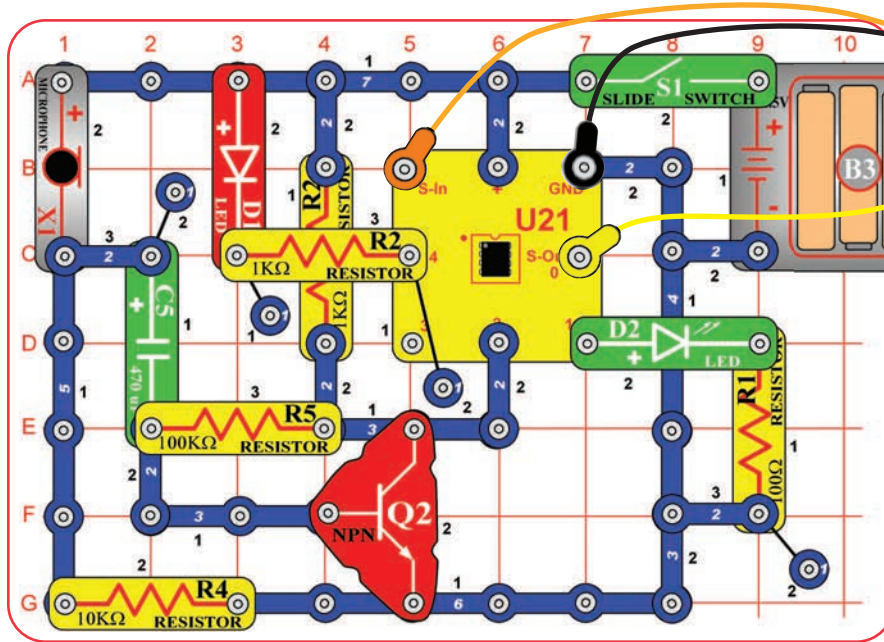

Disconnect cable after programming



In this circuit, you turn a light on and off by clapping. Build the circuit as shown. Turn on the slide switch (S1). Load program Clap Light into the microcontroller (U21) using the programming instructions in project B1. After programming, disconnect the programming cable; the circuit may not work properly if the cable is still connected.

When the program starts running, the green LED (D2) will be on for about 40 seconds and then turn off. During this time, the program is waiting for the 470µF capacitor (C5) to charge up. Just before the green LED goes off, the program measures the level of room background noise. If the room is very quiet, then the circuit will be more sensitive.

Now clapping will control the red LED (D1). Clap twice or more with a short pause between. The red LED (D1) should turn on or off. If the red LED doesn't change then keep clapping and adjust the time between claps. Sometimes tapping on the table may switch the red LED.

If your Clap Light still doesn't work then turn the switch off and on to reset and re-measure the room background noise. Keep the room quiet so there is less background noise, so the circuit will be more sensitive.

Optional:

'Program Clap Light
main:

```

high 1
wait 40
lbl_start: readadc 2,b0
           pause 20
           readadc 2,b1
           if b0=b1 then good_data
           if b0>b1 then lbl_reverse
           let b2=b1-b0
lbl_check: if b2> 5 then try_again
good_data: let w6 = w6 + b0
           let b3=b3+ 1
           if b3> 9 then lbl_settings
           let b0=b1
           goto lbl_2read

lbl_reverse: let b2=b0-b1
            goto lbl_check

lbl_settings: let b10 = w6/ 10
              let b11=b10+ 15
  
```

```

'Turn
'Wait
'Rea
'Pau
'Read audio and store in variable
'If b0 is equal to b1 goto good_data
'Reverse subtraction if b0 is great
'Get difference between b0 and b
'If too large, out of window, goto
'If good add it to running total
'Increase reading counter by 1
'If reading counter is 10 then goto
'If reading counter less than 10 le
'Go get new b1 reading

'Reverse the subtraction order, b1
'Goto check for good data line

'Get average for quiet reading
'Set upper start level at 15 above
  
```

Sounds into the microphone produce brief electrical signals, which are measured by the microcontroller. The microcontroller initially measures the room background noise as a reference, then looks for larger electrical signals that could be claps. Electrically, a clap is a sharp, brief burst of energy.

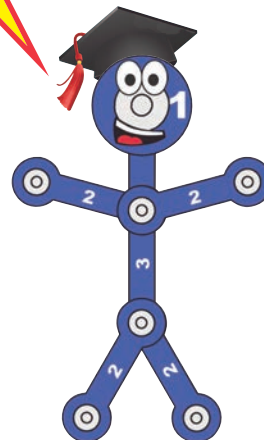

Project B26

Clap Music

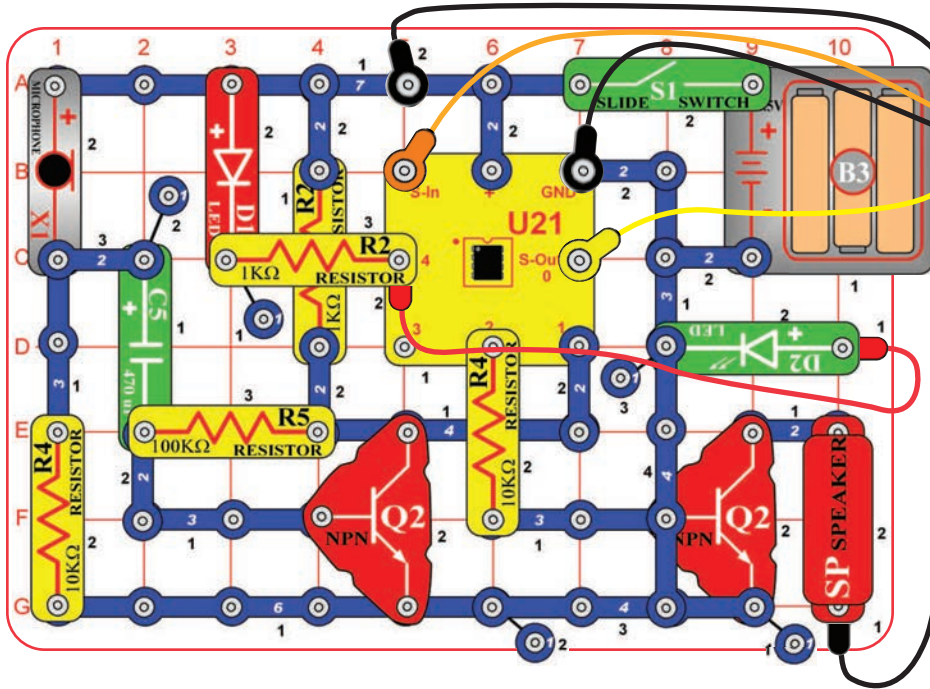

Disconnect cable
after programming

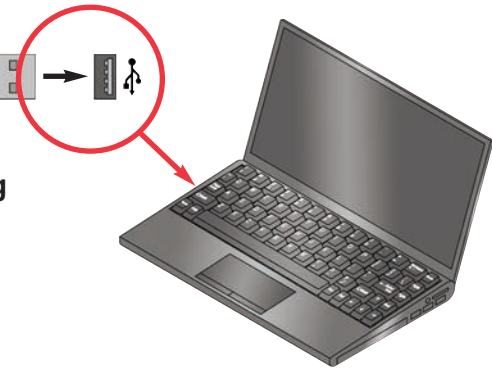

Optional:

'Program Clap Music
main:

	low 4	'Turn on start up light RED LED
	wait 40	'Wait 40 seconds for circuit to settle
lbl_start:	readadc 1,b0	'Read audio and store in variable b0
lbl_2read:	pause 20	'Pause for .02 seconds
	readadc 1,b1	'Read audio and store in variable b1
	if b0=b1 then good_data	'If b0 is equal to b1 goto good_data
	if b0>b1 then lbl_reverse	'Reverse subtraction if b0 is greater than b1
	let b2=b1-b0	'Get difference between b0 and b1
lbl_check:	if b2> 5 then try_again	'If too large, out of window, goto try_again
good_data:	let w6 = w6 + b0	'If good add it to running total
	let b3=b3+ 1	'Increase reading counter by 1
	if b3> 9 then lbl_settings	'If reading counter is 10 then goto lbl_settings
	let b0=b1	'If reading counter less than 10 let b0 = b1
	goto lbl_2read	'Go get new b1 reading
lbl_reverse:	let b2=b0-b1	'Reverse the subtraction order, b0 minus b1
	goto lbl_check	'Goto check for good data line
lbl_settings:	let b10 = w6/ 10	'Get average for quiet reading
	let b11=b10+ 15	'Set upper start level at 15 above quiet
	let b12=b10- 15	'Set lower start level at 15 below quiet

This project is similar to the Clap Light, except here you turn on music by clapping. Build the circuit as shown. Turn on the slide switch (S1). Load program Clap Music into the microcontroller (U21) using the programming instructions in project B1. After programming, disconnect the programming cable; the circuit may not work properly if the cable is still connected.

When the program starts running, the red LED (D1) will be on, but wait about 40 seconds until the green LED (D2) turns on. During this time, the program is waiting for the 470µF capacitor (C5) to charge up. Just before the green LED turns on, the program measures the level of room background noise. If the room is very quiet, then the circuit will be more sensitive.

Now clapping will control music. Clap twice or more with a short pause between. Music should start. If the music doesn't start then keep clapping and adjust the time between claps. Sometimes tapping on the table may start the music.

If your Clap Music still doesn't work then turn the switch off and on to reset and re-measure the room background noise. Keep the room quiet so there is less background noise, so the circuit will be more sensitive.



Project B27

Test the Microcontroller

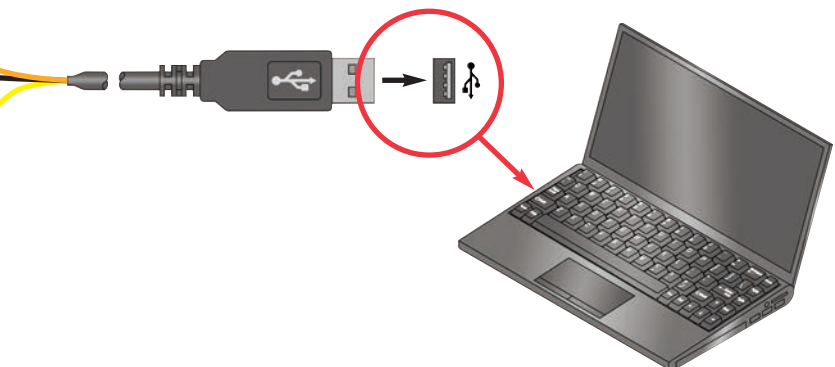
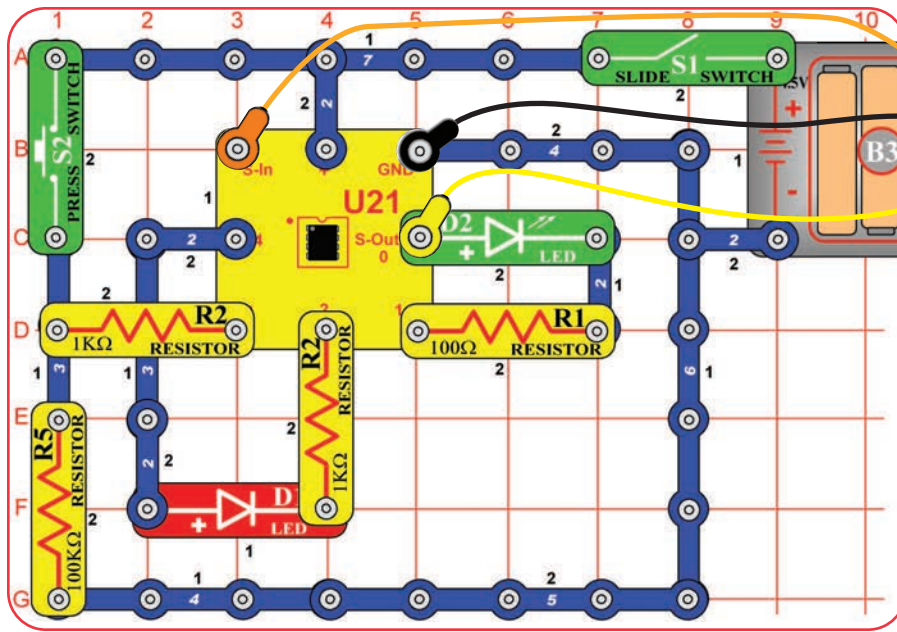

This project was created to test the microcontroller (U21) and all its connections, but is interesting and fun as well. It is referenced by point 11 of the Advanced Troubleshooting section on page 8. The programming cable and other Snap Circuits® parts can be tested independently by points 1-10 in the Advanced Troubleshooting section.

Build the circuit as shown. Turn on the slide switch (S1). Load the program Test the Microcontroller into the microcontroller using the programming instructions in project B1. Both LEDs (D1 & D2) should be on. Push the press switch (S2) to turn off the red LED. This confirms the microcontroller is working properly.

Note: If you get a “hardware not found” error while trying to download a program to the microcontroller: Start the download and then reset the circuit (switch the circuit off and on). A running program will be interrupted by a new download when it executes a command, but some commands (such as long pause or wait commands) can take too long to complete, so the download could be ignored. Resetting the microcontroller just after initiating a download ensures that the microcontroller will recognize the new download. If you still get an error then test your programming cable using point 10 of the Advanced Troubleshooting. If it still doesn’t work then your microcontroller is damaged.

Optional:

```

Program Test the Microcontroller
main:
  low 1
  low 2
  high 0
  high 4
  wait 1
label_A:
  if pin3=0 then goto label_A
  low 4
  
```

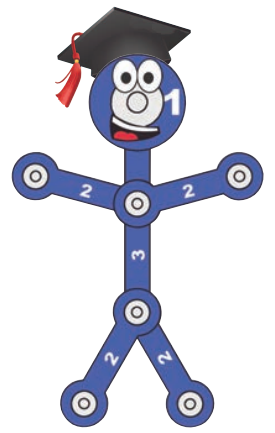

PART C - To Go Further

Snap Circuits® XP™ is an introduction to what you can do with microcontrollers, such as the PICAXE® 08M2 IC that you have been using. This section is intended for users who would like to develop their own programs for the microcontroller. **Review the DO's and DON'Ts of Building Circuits on page 8 before experimenting on your own.**

BASIC Programming:

The programs you are using are written in a language called BASIC. BASIC (short for Beginner's All-purpose Symbolic Instruction Code) is a language of symbolic commands, which will later be translated into coded instructions that the microcontroller can understand and execute. The microcontroller you have can process about 1000 BASIC commands a second.

You can download 80-220 lines of code in the microcontroller (the PICAXE® 08M2), depending on the commands used. Other PICAXE® parts available can hold as much as 3200 lines of code. As programs become complex it is possible the micro-controller will run out of memory to store the program. Most programs can be reduced in size by rewriting to use more subroutines. You can check the program length using 'Syntax'.

A description of all the microcontroller commands and some basic programming techniques can be found under the Help menu at **Snap Circuits® XP™**.

The **PICAXE® Manual (Parts 1, 2, and 3)** has more detailed explanations of the PICAXE® commands, and other information about PICAXE® products, however much of this information is not applicable to Snap Circuits® XP™ and some is very technical. The Snap Circuits® XP™ help file is customized to your product.

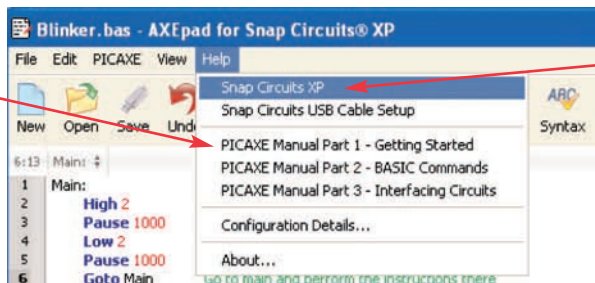

The PICAXE® Interface and Programming Software

The Snap Circuits® XP™ Editor makes downloading programs to the microcontroller easy. It also allows you to easily change parameters in programs before downloading. However, we do not recommend developing new programs with it, because more advanced editors are available with features like simulation and flowcharting.

The microcontroller you are using has a special programming interface that makes it easy to use. This interface, called PICAXE®, was developed by Revolution Education Ltd.. Revolution Education's PICAXE® website, www.rev-ed.co.uk/picaxe, contains the following:

- More information about PICAXE® microcontrollers and software. This includes information on the larger PICAXE® IC's that are available, and where you may purchase them.
- **Logicator:** Logicator is more advanced software for programming PICAXE® microcontrollers, including yours. We recommend this as the best software for young users who are creating their own programs for the microcontroller, due to its ease of use. Programs are created as graphical flowcharts, not as typed BASIC programs. The flowcharts make creating programs easy

because you select the commands as symbols from menus, then select the parameters you need from a list. Flowcharts make it easy to see how different parts of a program relate. With Logicator you can simulate a program to see how it will work, before downloading it into the microcontroller. Logicator is available on the PICAXE® website as a free download. Further information and a sample Logicator screen is on the next page.

- **Programming Editor:** The Programming Editor is the most advanced software for programming PICAXE® microcontrollers, including yours. We recommend this as the best software for advanced users who are creating their own programs for the microcontroller, due to its range of features. Programs are written in BASIC, but may also be created as flowcharts (though the flowcharts here are not as easy to use as those in Logicator). All PICAXE® features are supported. Great simulation tools, to help you test complex programs before downloading them to the microcontroller. The Programming Editor is available on the PICAXE® website as a free download. Most of the programs for Snap Circuits® XP™ were created using the Programming Editor. Further information and a sample Programming Editor screen is on page 61.

Notes on Logicator

- The software may give you a warning about your download cable not being installed correctly; don't worry, your cable style is different but it is compatible and will work.
- We suggest you begin by viewing the **Logicator manual**, which can be found under the Help menu.
- When you begin, you will need to **select the PIC type** and COM port; these can be found under the Options menu. Your PIC is the PICAXE08M2. Your COM port is the same one shown in the XP Editor. See the Logicator manual for more explanation.
- Logicator programs may be converted to BASIC; BASIC programs can be used with Logicator but in an abstract manner.

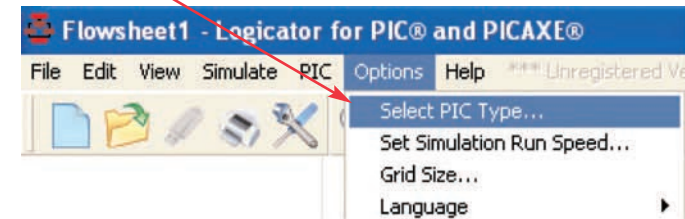
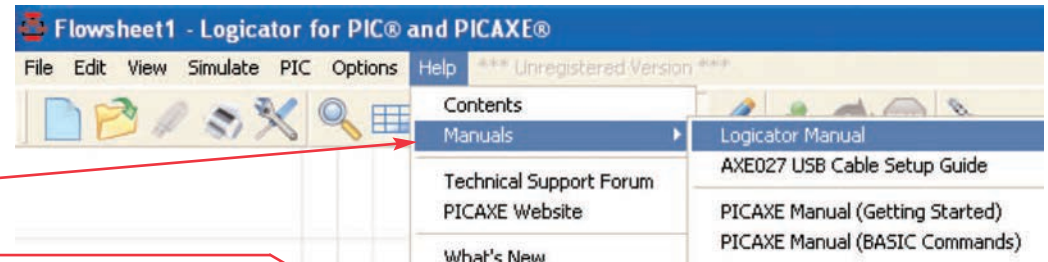

Sample Logicator Screen

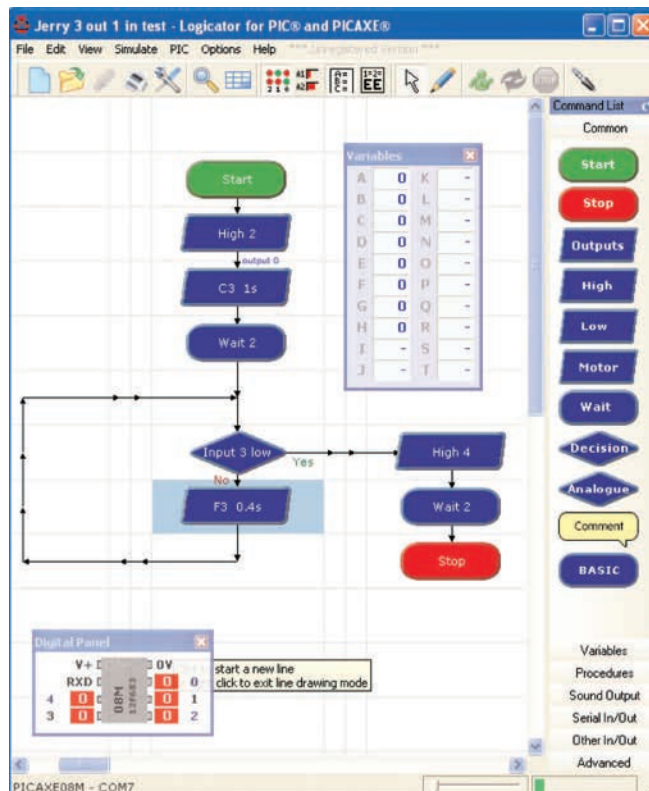

The flowcharts have symbolic commands. These are similar to BASIC commands, but are presented graphically so it is easier to see the program structure.

Flowcharts can be thought of as road maps for writing programs, because they give you a better idea of where you are and where you are going. Flowcharts make it easier to see how different parts of a program relate, reducing mistakes.

Flowcharts may seem confusing at first, but actually they are easy to use. With flowcharts you just select commands from the menus and enter parameters, while with BASIC you have to remember commands and type them in just right.

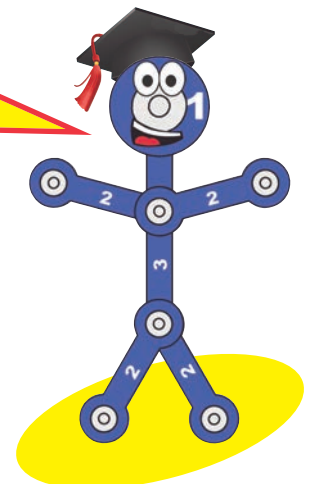

Notes on Programming Editor

- When you begin, you will need to select the **Mode and COM port**. Set the mode to 08M2. See the PICAXE Getting Started manual for more explanation.
- We suggest you begin by viewing the **PICAXE Getting Started**, which can be found under the Help menu.
- The same BASIC programs may be used with the Programming Editor and AXEpad for Snap Circuits® XP™.

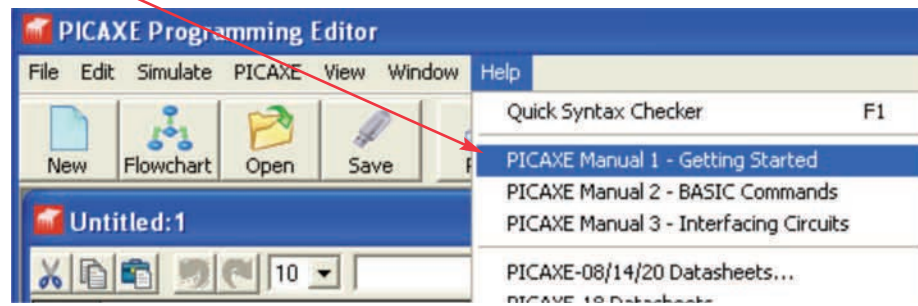
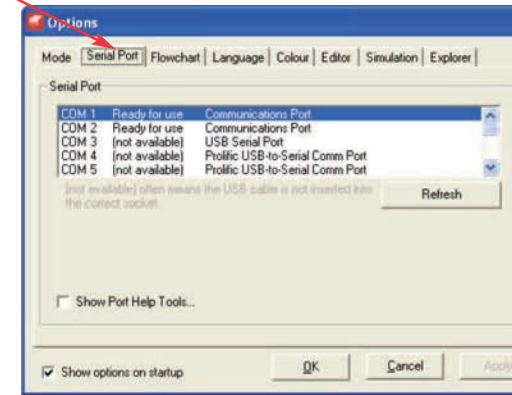
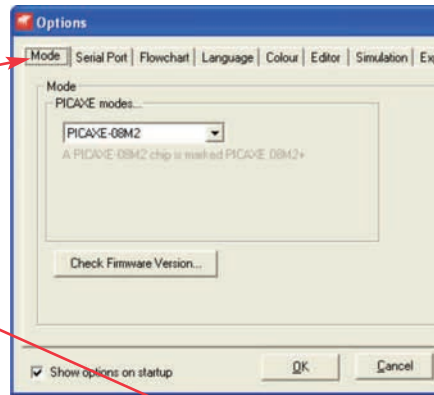

Sample Programming Editor Screen

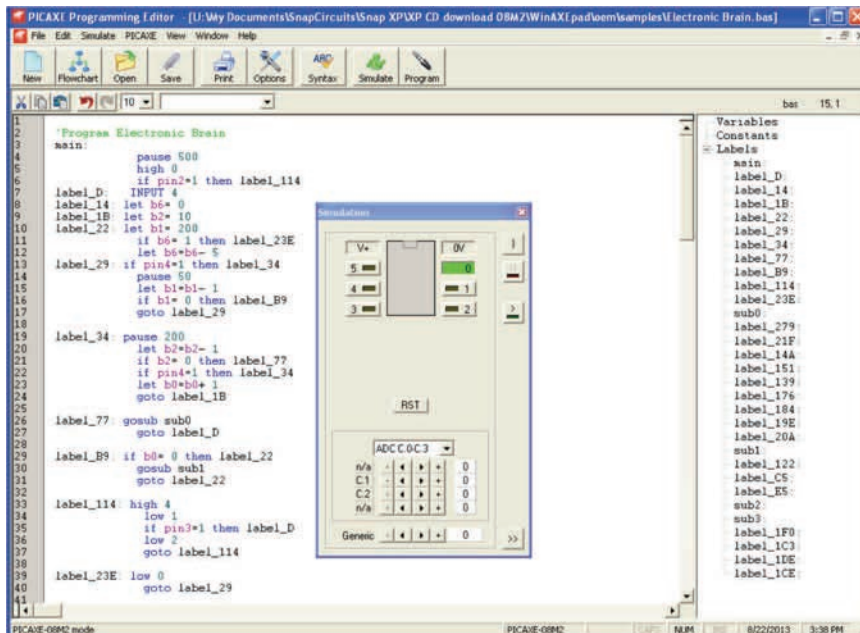

Sample Programming Editor Screen - Flowchart mode

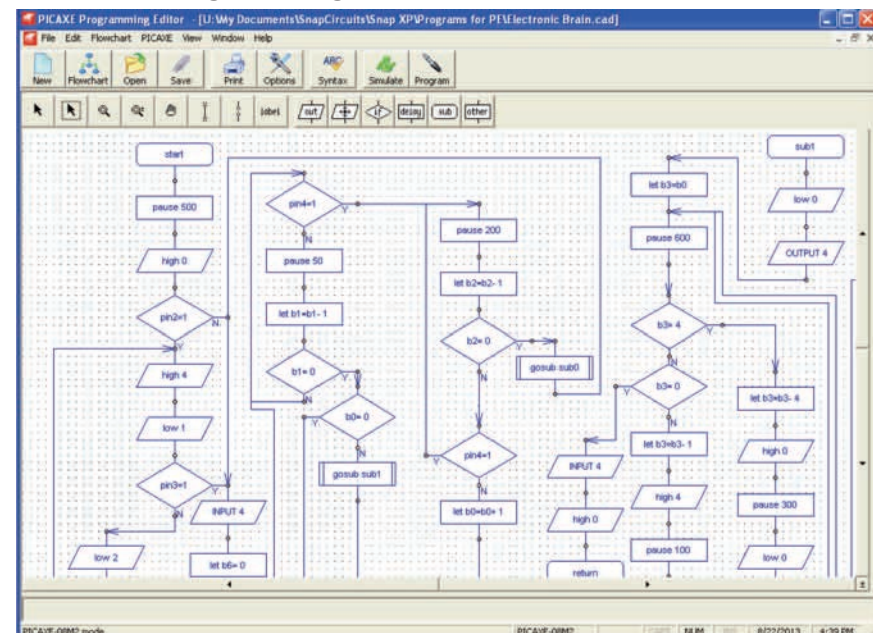

OTHER SNAP CIRCUITS® PRODUCTS!

For a listing of local toy retailers who carry Snap Circuits® visit www.elenco.com or call us toll-free at 800-533-2441. For Snap Circuits® upgrade kits, accessories, additional parts, and more information about your parts visit www.snapcircuits.net.

Snap Circuits® Jr. Model SC-100



Build over 100 projects

Including:

- Flying saucer
- Spin draw
- Sound activated switch
- Alarm circuit

Contains over 30 parts

Including:

- Photoresistor
- Motor
- Music IC
- Space War IC

Snap Circuits® Model SC-300



Build over 300 projects

Including:

- AM radio
- Radio announcer
- Lie detector
- Burglar alarm

Contains over 60 parts

Including:

- Two transistors
- Microphone
- Power amplifier IC
- Variable capacitor

Snap Circuits® Pro Model SC-500



Build over 500 projects

Including:

- Digitally tuned FM radio
- Adjustable light control
- Digital voice recorder
- AC generator

Contains over 75 parts

Including:

- Recording IC
- FM module
- Transformer
- Analog meter

Snap Circuits® Extreme Model SC-750



Build over 750 projects

Including:

- Strobe light
- Transistor AM radio
- Electromagnetism
- Rechargeable battery

Contains over 80 parts

Including:

- Solar cell
- Electromagnet
- Vibration switch
- Computer interface

Snap Circuits® Light Model SCL-175



Build over 175 projects

Including:

- Fiber Fun
- Dancing Lights
- Follow the Music
- Audio Infrared Detector

Contains over 55 parts

Including:

Strobe light, color organ, infrared detector, color changing LED, fiber optic cable, and more!

Deluxe Snap Rover® Model SCROV-50



Features:

- Disc shooter
- Digital voice recorder
- Music sounds
- Goes forward & backward
- Headlight
- Red & blue side lights
- Wireless remote control
- Left & right turning control

**Contains over 60 projects
and over 50 parts**

Snap Circuits® Green Model SCG-125



Alternative Energy Kit

Build over **125 projects** and have loads of fun learning about environmentally-friendly energy and how the electricity in your home works. Includes full-color manual with over 100 pages and separate educational manual. This educational manual will explain all the forms of environmentally-friendly energy including: geothermal, hydrogen fuel cells, wind, solar, tidal, hydro, and others. Contains over 40 parts.

Snaptricity® Model SCBE-75



Build over 75 projects

Projects relate to electricity in the home and magnetism and how it is used.

Contains over 40 parts

Including:

Meter, electromagnet, motor, lamps, switches, fan, compass, and electrodes.

SCXP-50 XP™ Block Layout

Important: If any parts are missing or damaged, **DO NOT RETURN TO RETAILER.**

Call toll-free (800) 533-2441 or e-mail us at: help@elenco.com. Customer Service • 150 Carpenter Ave. Wheeling, IL 60090 U.S.A.

