



SIOV metal oxide varistors

Leaded varistors, StandarD series

Series/Type: S05, S07, S10, S14, S20

Date: December 2007

Leaded varistors

Standard series

Construction

- Round varistor element, leaded
- Coating: epoxy resin, flame-retardant to UL 94 V-0
- Terminals: tinned copper wire

Features

- Wide operating voltage range 11 ... 1100 V_{RMS}
- High surge current ratings up to 8 kA
- No derating up to 85 °C ambient temperature
- PSpice models

Approvals

- UL
- CSA (all types ≥K115)
- SEV
- VDE
- CECC
- CQC S05/07 (K11 ... K460), S10/S14 (K11 ... K680), S20 (K11 ... K1100)
- IEC

Delivery mode

- Bulk (standard), taped versions on reel or in Ammo pack upon request.
- For further details refer to chapter "Taping, packaging and lead configuration" for leaded varistors.

Options

S10* types with lead spacing 5.0 mm and S20* types with lead spacing 7.5 mm are also available on request.

General technical data

Climatic category	to IEC 60068-1	40/85/56	
Operating temperature	to CECC 42 000	-40 ... + 85	°C
Storage temperature		-40 ... +125	°C
Electric strength	to CECC 42 000	≥2.5	kV _{RMS}
Insulation resistance	to CECC 42 000	≥10	MΩ
Response time		<25	ns

Leaded varistors
Standard series
Maximum ratings ($T_A = 85\text{ °C}$)

Ordering code	Type (untaped) SIOV-	V_{RMS}	V_{DC}	i_{max} (8/20 μ s)	W_{max} (2 ms)	P_{max}
		V	V	A	J	W
B72205S0110K101	S05K11	11	14	100	0.3	0.01
B72207S0110K101	S07K11	11	14	250	0.8	0.02
B72210S0110K101	S10K11	11	14	500	1.7	0.05
B72214S0110K101	S14K11	11	14	1000	3.2	0.10
B72220S0110K101	S20K11	11	14	2000	10.0	0.20
B72205S0140K101	S05K14	14	18	100	0.4	0.01
B72207S0140K101	S07K14	14	18 ¹⁾	250	0.9	0.02
B72210S0140K101	S10K14	14	18 ¹⁾	500	2.0	0.05
B72214S0140K101	S14K14	14	18 ¹⁾	1000	4.0	0.10
B72220S0140K101	S20K14	14	18 ¹⁾	2000	12.0	0.20
B72205S0170K101	S05K17	17	22	100	0.5	0.01
B72207S0170K101	S07K17	17	22	250	1.1	0.02
B72210S0170K101	S10K17	17	22	500	2.5	0.05
B72214S0170K101	S14K17	17	22	1000	5.0	0.10
B72220S0170K101	S20K17	17	22	2000	14.0	0.20
B72205S0200K101	S05K20	20	26	100	0.6	0.01
B72207S0200K101	S07K20	20	26	250	1.3	0.02
B72210S0200K101	S10K20	20	26	500	3.1	0.05
B72214S0200K101	S14K20	20	26	1000	6.0	0.10
B72220S0200K101	S20K20	20	26	2000	18.0	0.20
B72205S0250K101	S05K25	25	31	100	0.7	0.01
B72207S0250K101	S07K25	25	31	250	1.6	0.02
B72210S0250K101	S10K25	25	31	500	3.7	0.05
B72214S0250K101	S14K25	25	31	1000	7.0	0.10
B72220S0250K101	S20K25	25	31	2000	22.0	0.20
B72205S0300K101	S05K30	30	38	100	0.9	0.01
B72207S0300K101	S07K30	30	38	250	2.0	0.02
B72210S0300K101	S10K30	30	38	500	4.4	0.05
B72214S0300K101	S14K30	30	38	1000	9.0	0.10
B72220S0300K101	S20K30	30	38	2000	26.0	0.20

1) Jump-start strength (max. 24 V, 5 minutes)



Leaded varistors

Standard series

Characteristics ($T_A = 25\text{ °C}$)

Ordering code	V_V (1 mA) V	ΔV_V (1 mA) %	$V_{C, \max}$ (i_C) V	i_C A	C_{typ} (1 kHz) pF
B72205S0110K101	18	±10	36	1.0	1750
B72207S0110K101	18	±10	36	2.5	2750
B72210S0110K101	18	±10	36	5.0	6250
B72214S0110K101	18	±10	36	10.0	12100
B72220S0110K101	18	±10	36	20.0	23000
B72205S0140K101	22	±10	43	1.0	1450
B72207S0140K101	22	±10	43	2.5	2300
B72210S0140K101	22	±10	43	5.0	5200
B72214S0140K101	22	±10	43	10.0	9950
B72220S0140K101	22	±10	43	20.0	19000
B72205S0170K101	27	±10	53	1.0	1200
B72207S0170K101	27	±10	53	2.5	1900
B72210S0170K101	27	±10	53	5.0	4350
B72214S0170K101	27	±10	53	10.0	8200
B72220S0170K101	27	±10	53	20.0	15600
B72205S0200K101	33	±10	65	1.0	980
B72207S0200K101	33	±10	65	2.5	1600
B72210S0200K101	33	±10	65	5.0	3650
B72214S0200K101	33	±10	65	10.0	6800
B72220S0200K101	33	±10	65	20.0	13000
B72205S0250K101	39	±10	77	1.0	850
B72207S0250K101	39	±10	77	2.5	1400
B72210S0250K101	39	±10	77	5.0	3200
B72214S0250K101	39	±10	77	10.0	5850
B72220S0250K101	39	±10	77	20.0	11100
B72205S0300K101	47	±10	93	1.0	720
B72207S0300K101	47	±10	93	2.5	1200
B72210S0300K101	47	±10	93	5.0	2750
B72214S0300K101	47	±10	93	10.0	4950
B72220S0300K101	47	±10	93	20.0	9350

Leaded varistors
Standard series
Maximum ratings ($T_A = 85\text{ °C}$)

Ordering code	Type (untaped) SIOV-	V_{RMS}	V_{DC}	i_{max} (8/20 μ s)	W_{max} (2 ms)	P_{max}
		V	V	A	J	W
B72205S0350K101	S05K35	35	45	100	1.1	0.01
B72207S0350K101	S07K35	35	45	250	2.5	0.02
B72210S0350K101	S10K35	35	45	500	5.4	0.05
B72214S0350K101	S14K35	35	45	1000	10.0	0.10
B72220S0350K101	S20K35	35	45	2000	33.0	0.20
B72205S0400K101	S05K40	40	56	100	1.3	0.01
B72207S0400K101	S07K40	40	56	250	3.0	0.02
B72210S0400K101	S10K40	40	56	500	6.4	0.05
B72214S0400K101	S14K40	40	56	1000	13.0	0.10
B72220S0400K101	S20K40	40	56	2000	37.0	0.20
B72205S0500K101	S05K50	50	65	400	1.8	0.10
B72207S0500K101	S07K50	50	65	1200	4.2	0.25
B72210S0500K101	S10K50	50	65	2500	8.4	0.40
B72214S0500K101	S14K50	50	65	4500	15.0	0.60
B72220S0500K101	S20K50	50	65	6500	27.0	1.00
B72205S0600K101	S05K60	60	85	400	2.2	0.10
B72207S0600K101	S07K60	60	85	1200	4.8	0.25
B72210S0600K101	S10K60	60	85	2500	10.0	0.40
B72214S0600K101	S14K60	60	85	4500	17.0	0.60
B72220S0600K101	S20K60	60	85	6500	33.0	1.00
B72205S0750K101	S05K75	75	100	400	2.5	0.10
B72207S0750K101	S07K75	75	100	1200	5.9	0.25
B72210S0750K101	S10K75	75	100	2500	12.0	0.40
B72214S0750K101	S14K75	75	100	4500	20.0	0.60
B72220S0750K101	S20K75	75	100	6500	40.0	1.00
B72205S0950K101	S05K95	95	125	400	3.4	0.10
B72207S0950K101	S07K95	95	125	1200	7.6	0.25
B72210S0950K101	S10K95	95	125	2500	15.0	0.40
B72214S0950K101	S14K95	95	125	4500	25.0	0.60
B72220S0950K101	S20K95	95	125	6500	50.0	1.00

Leaded varistors
Standard series
Characteristics ($T_A = 25\text{ °C}$)

Ordering code	V_V (1 mA) V	ΔV_V (1 mA) %	$V_{c, \max}$ (i_c) V	i_c A	C_{typ} (1 kHz) pF
B72205S0350K101	56	± 10	110	1.0	620
B72207S0350K101	56	± 10	110	2.5	1050
B72210S0350K101	56	± 10	110	5.0	2400
B72214S0350K101	56	± 10	110	10.0	4200
B72220S0350K101	56	± 10	110	20.0	8000
B72205S0400K101	68	± 10	135	1.0	520
B72207S0400K101	68	± 10	135	2.5	900
B72210S0400K101	68	± 10	135	5.0	2100
B72214S0400K101	68	± 10	135	10.0	3550
B72220S0400K101	68	± 10	135	20.0	6750
B72205S0500K101	82	± 10	135	5.0	300
B72207S0500K101	82	± 10	135	10.0	530
B72210S0500K101	82	± 10	135	25.0	950
B72214S0500K101	82	± 10	135	50.0	1800
B72220S0500K101	82	± 10	135	100.0	3800
B72205S0600K101	100	± 10	165	5.0	250
B72207S0600K101	100	± 10	165	10.0	480
B72210S0600K101	100	± 10	165	25.0	870
B72214S0600K101	100	± 10	165	50.0	1650
B72220S0600K101	100	± 10	165	100.0	3600
B72205S0750K101	120	± 10	200	5.0	210
B72207S0750K101	120	± 10	200	10.0	430
B72210S0750K101	120	± 10	200	25.0	720
B72214S0750K101	120	± 10	200	50.0	1370
B72220S0750K101	120	± 10	200	100.0	2900
B72205S0950K101	150	± 10	250	5.0	135
B72207S0950K101	150	± 10	250	10.0	260
B72210S0950K101	150	± 10	250	25.0	530
B72214S0950K101	150	± 10	250	50.0	870
B72220S0950K101	150	± 10	250	100.0	1830

Leaded varistors
Standard series
Maximum ratings ($T_A = 85\text{ °C}$)

Ordering code	Type (untaped) SIOV-	V_{RMS}	V_{DC}	i_{max} (8/20 μ s)	W_{max} (2 ms)	P_{max}
		V	V	A	J	W
B72205S0111K101	S05K115	115	150	400	3.6	0.10
B72207S0111K101	S07K115	115	150	1200	8.4	0.25
B72210S0111K101	S10K115	115	150	2500	18.0	0.40
B72214S0111K101	S14K115	115	150	4500	30.0	0.60
B72220S0111K101	S20K115	115	150	6500	60.0	1.00
B72205S0131K101	S05K130	130	170	400	4.2	0.10
B72207S0131K101	S07K130	130	170	1200	9.5	0.25
B72210S0131K101	S10K130	130	170	2500	19.0	0.40
B72214S0131K101	S14K130	130	170	4500	34.0	0.60
B72220S0131K101	S20K130	130	170	8000	74.0	1.00
B72205S0141K101	S05K140	140	180	400	4.5	0.10
B72207S0141K101	S07K140	140	180	1200	10.0	0.25
B72210S0141K101	S10K140	140	180	2500	22.0	0.40
B72214S0141K101	S14K140	140	180	4500	36.0	0.60
B72220S0141K101	S20K140	140	180	8000	78.0	1.00
B72205S0151K101	S05K150	150	200	400	4.9	0.10
B72207S0151K101	S07K150	150	200	1200	11.0	0.25
B72210S0151K101	S10K150	150	200	2500	24.0	0.40
B72214S0151K101	S14K150	150	200	4500	40.0	0.60
B72220S0151K101	S20K150	150	200	8000	85.0	1.00
B72205S0171K101	S05K175	175	225	400	5.6	0.10
B72207S0171K101	S07K175	175	225	1200	13.0	0.25
B72210S0171K101	S10K175	175	225	2500	28.0	0.40
B72214S0171K101	S14K175	175	225	4500	46.0	0.60
B72220S0171K101	S20K175	175	225	8000	98.0	1.00
B72205S0231K101	S05K230	230	300	400	7.2	0.10
B72207S0231K101	S07K230	230	300	1200	17.0	0.25
B72210S0231K101	S10K230	230	300	2500	36.0	0.40
B72214S0231K101	S14K230	230	300	4500	60.0	0.60
B72220S0231K101	S20K230	230	300	8000	130.0	1.00
B72205S0251K101	S05K250	250	320	400	8.2	0.10
B72207S0251K101	S07K250	250	320	1200	19.0	0.25
B72210S0251K101	S10K250	250	320	2500	38.0	0.40
B72214S0251K101	S14K250	250	320	4500	65.0	0.60
B72220S0251K101	S20K250	250	320	8000	140.0	1.00

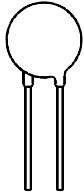
Leaded varistors
Standard series
Characteristics ($T_A = 25\text{ °C}$)

Ordering code	V_V (1 mA) V	ΔV_V (1 mA) %	$V_{c, \max}$ (i_c) V	i_c A	C_{typ} (1 kHz) pF
B72205S0111K101	180	±10	300	5.0	110
B72207S0111K101	180	±10	300	10.0	220
B72210S0111K101	180	±10	300	25.0	445
B72214S0111K101	180	±10	300	50.0	730
B72220S0111K101	180	±10	300	100.0	1520
B72205S0131K101	205	±10	340	5.0	100
B72207S0131K101	205	±10	340	10.0	200
B72210S0131K101	205	±10	340	25.0	400
B72214S0131K101	205	±10	340	50.0	650
B72220S0131K101	205	±10	340	100.0	1340
B72205S0141K101	220	±10	360	5.0	95
B72207S0141K101	220	±10	360	10.0	180
B72210S0141K101	220	±10	360	25.0	370
B72214S0141K101	220	±10	360	50.0	610
B72220S0141K101	220	±10	360	100.0	1240
B72205S0151K101	240	±10	395	5.0	90
B72207S0151K101	240	±10	395	10.0	170
B72210S0151K101	240	±10	395	25.0	350
B72214S0151K101	240	±10	395	50.0	570
B72220S0151K101	240	±10	395	100.0	1160
B72205S0171K101	270	±10	455	5.0	75
B72207S0171K101	270	±10	455	10.0	150
B72210S0171K101	270	±10	455	25.0	300
B72214S0171K101	270	±10	455	50.0	490
B72220S0171K101	270	±10	455	100.0	1000
B72205S0231K101	360	±10	595	5.0	60
B72207S0231K101	360	±10	595	10.0	115
B72210S0231K101	360	±10	595	25.0	230
B72214S0231K101	360	±10	595	50.0	380
B72220S0231K101	360	±10	595	100.0	760
B72205S0251K101	390	±10	650	5.0	55
B72207S0251K101	390	±10	650	10.0	105
B72210S0251K101	390	±10	650	25.0	215
B72214S0251K101	390	±10	650	50.0	350
B72220S0251K101	390	±10	650	100.0	700

Leaded varistors
Standard series
Maximum ratings ($T_A = 85\text{ °C}$)

Ordering code	Type (untaped) SIOV-	V_{RMS}	V_{DC}	i_{max} (8/20 μ s)	W_{max} (2 ms)	P_{max}
		V	V	A	J	W
B72205S0271K101	S05K275	275	350	400	8.6	0.10
B72207S0271K101	S07K275	275	350	1200	21.0	0.25
B72210S0271K101	S10K275	275	350	2500	43.0	0.40
B72214S0271K101	S14K275	275	350	4500	71.0	0.60
B72220S0271K101	S20K275	275	350	8000	151.0	1.00
B72205S0301K101	S05K300	300	385	400	9.6	0.10
B72207S0301K101	S07K300	300	385	1200	23.0	0.25
B72210S0301K101	S10K300	300	385	2500	47.0	0.40
B72214S0301K101	S14K300	300	385	4500	76.0	0.60
B72220S0301K101	S20K300	300	385	8000	173.0	1.00
B72210S0321K101	S10K320	320	420	2500	50.0	0.40
B72214S0321K101	S14K320	320	420	4500	84.0	0.60
B72220S0321K101	S20K320	320	420	8000	184.0	1.00
B72205S0381K101	S05K385	385	505	400	13.0	0.10
B72207S0381K101	S07K385	385	505	1200	28.0	0.25
B72210S0381K101	S10K385	385	505	2500	40.0	0.40
B72214S0381K101	S14K385	385	505	4500	80.0	0.60
B72220S0381K101	S20K385	385	505	8000	150.0	1.00
B72205S0421K101	S05K420	420	560	400	14.0	0.10
B72207S0421K101	S07K420	420	560	1200	32.0	0.25
B72210S0421K101	S10K420	420	560	2500	45.0	0.40
B72214S0421K101	S14K420	420	560	4500	90.0	0.60
B72220S0421K101	S20K420	420	560	8000	175.0	1.00
B72205S0441K101	S05K440	440	585	400	16.0	0.10
B72207S0441K101	S07K440	440	585	1200	34.0	0.25
B72210S0441K101	S10K440	440	585	2500	47.0	0.40
B72214S0441K101	S14K440	440	585	4500	95.0	0.60
B72220S0441K101	S20K440	440	585	8000	185.0	1.00
B72205S0461K101	S05K460	460	615	400	18.0	0.10
B72207S0461K101	S07K460	460	615	1200	36.0	0.25
B72210S0461K101	S10K460	460	615	2500	50.0	0.40
B72214S0461K101	S14K460	460	615	4500	100.0	0.60
B72220S0461K101	S20K460	460	615	8000	195.0	1.00

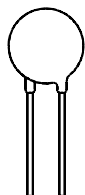
Leaded varistors
Standard series
Characteristics ($T_A = 25\text{ °C}$)

Ordering code	V_V (1 mA) V	ΔV_V (1 mA) %	$V_{c, \max}$ (i_c) V	i_c A	C_{typ} (1 kHz) pF
B72205S0271K101	430	±10	710	5.0	50
B72207S0271K101	430	±10	710	10.0	95
B72210S0271K101	430	±10	710	25.0	195
B72214S0271K101	430	±10	710	50.0	320
B72220S0271K101	430	±10	710	100.0	630
B72205S0301K101	470	±10	775	5.0	45
B72207S0301K101	470	±10	775	10.0	90
B72210S0301K101	470	±10	775	25.0	180
B72214S0301K101	470	±10	775	50.0	300
B72220S0301K101	470	±10	775	100.0	580
B72210S0321K101	510	±10	840	25.0	170
B72214S0321K101	510	±10	840	50.0	280
B72220S0321K101	510	±10	840	100.0	540
B72205S0381K101	620	±10	1025	5.0	40
B72207S0381K101	620	±10	1025	10.0	75
B72210S0381K101	620	±10	1025	25.0	150
B72214S0381K101	620	±10	1025	50.0	240
B72220S0381K101	620	±10	1025	100.0	450
B72205S0421K101	680	±10	1120	5.0	35
B72207S0421K101	680	±10	1120	10.0	65
B72210S0421K101	680	±10	1120	25.0	135
B72214S0421K101	680	±10	1120	50.0	220
B72220S0421K101	680	±10	1120	100.0	420
B72205S0441K101	715	±10	1180	5.0	32
B72207S0441K101	715	±10	1180	10.0	60
B72210S0441K101	715	±10	1180	25.0	125
B72214S0441K101	715	±10	1180	50.0	210
B72220S0441K101	715	±10	1180	100.0	400
B72205S0461K101	750	±10	1240	5.0	30
B72207S0461K101	750	±10	1240	10.0	55
B72210S0461K101	750	±10	1240	25.0	120
B72214S0461K101	750	±10	1240	50.0	200
B72220S0461K101	750	±10	1240	100.0	380

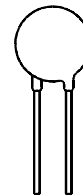
Leaded varistors
Standard series
Maximum ratings ($T_A = 85\text{ °C}$)

Ordering code	Type (untaped) SIOV-	V_{RMS}	V_{DC}	i_{max} (8/20 μ s)	W_{max} (2 ms)	P_{max}
		V	V	A	J	W
B72210S0511K101	S10K510	510	670	2500	55.0	0.40
B72214S0511K101	S14K510	510	670	4500	110.0	0.60
B72220S0511K101	S20K510	510	670	6500	190.0	1.00
B72210S0551K101	S10K550	550	745	2500	60.0	0.40
B72214S0551K101	S14K550	550	745	4500	120.0	0.60
B72220S0551K101	S20K550	550	745	6500	210.0	1.00
B72210S0621K101	S10K625	625	825	2500	68.0	0.40
B72214S0621K101	S14K625	625	825	4500	130.0	0.60
B72220S0621K101	S20K625	625	825	6500	230.0	1.00
B72210S0681K101	S10K680	680	895	2500	72.0	0.40
B72214S0681K101	S14K680	680	895	4500	140.0	0.60
B72220S0681K101	S20K680	680	895	6500	250.0	1.00
B72214S0102K101	S14K1000 ¹⁾	1100	1465	4500	230.0	0.60
B72220S0102K101	S20K1000 ¹⁾	1100	1465	6500	410.0	1.00

1) Operating voltage differs from type designation.



Leaded varistors
Standard series
Characteristics ($T_A = 25\text{ °C}$)

Ordering code	V_V (1 mA) V	ΔV_V (1 mA) %	$V_{c, \max}$ (i_c) V	i_c A	C_{typ} (1 kHz) pF
B72210S0511K101	820	± 10	1355	25.0	110
B72214S0511K101	820	± 10	1355	50.0	180
B72220S0511K101	820	± 10	1355	100.0	340
B72210S0551K101	910	± 10	1500	25.0	105
B72214S0551K101	910	± 10	1500	50.0	170
B72220S0551K101	910	± 10	1500	100.0	320
B72210S0621K101	1000	± 10	1650	25.0	90
B72214S0621K101	1000	± 10	1650	50.0	150
B72220S0621K101	1000	± 10	1650	100.0	280
B72210S0681K101	1100	± 10	1815	25.0	85
B72214S0681K101	1100	± 10	1815	50.0	140
B72220S0681K101	1100	± 10	1815	100.0	250
B72214S0102K101	1800	± 10	2970	50.0	100
B72220S0102K101	1800	± 10	2970	100.0	170

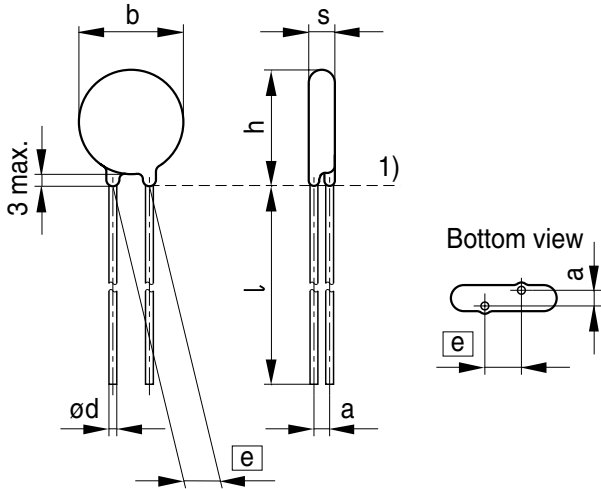

Leaded varistors
Standard series

Dimensional drawing



1) Seating plane to IEC 60717

VAR0408-C

Weight

Nominal diameter mm	V _{RMS} V	Weight g
5	11 ... 460	0.3 ... 0.7
7	11 ... 460	0.4 ... 1.1
10	11 ... 680	1.0 ... 3.0
14	11 ... 1000	1.4 ... 7.6
20	11 ... 1000	2.7 ... 15.7

The weight of varistors in between these voltage classes can be interpolated.

Dimensions

Ordering code	e ±1 mm	a ±1 mm	b _{max} mm	s _{max} mm	h _{max} mm	l _{min} mm	d ±0.05 mm
B72205S0110K101	5.0	1.2	7.0	3.3	8.5	25.0	0.6
B72207S0110K101	5.0	1.2	9.0	3.4	11.0	25.0	0.6
B72210S0110K101	7.5	1.4	12.0	4.0	14.5	25.0	0.8
B72214S0110K101	7.5	1.4	15.5	4.0	18.5	25.0	0.8
B72220S0110K101	10.0	1.5	21.5	4.5	25.5	25.0	1.0
B72205S0140K101	5.0	1.3	7.0	3.4	8.5	25.0	0.6
B72207S0140K101	5.0	1.3	9.0	3.5	11.0	25.0	0.6
B72210S0140K101	7.5	1.5	12.0	4.2	14.5	25.0	0.8
B72214S0140K101	7.5	1.5	15.5	4.2	18.5	25.0	0.8
B72220S0140K101	10.0	1.6	21.5	4.6	25.5	25.0	1.0
B72205S0170K101	5.0	1.4	7.0	3.5	8.5	25.0	0.6
B72207S0170K101	5.0	1.4	9.0	3.6	11.0	25.0	0.6
B72210S0170K101	7.5	1.6	12.0	4.4	14.5	25.0	0.8
B72214S0170K101	7.5	1.7	15.5	4.4	18.5	25.0	0.8
B72220S0170K101	10.0	1.8	21.5	4.8	25.5	25.0	1.0
B72205S0200K101	5.0	1.2	7.0	3.5	8.5	25.0	0.6
B72207S0200K101	5.0	1.2	9.0	3.6	11.0	25.0	0.6
B72210S0200K101	7.5	1.8	12.0	4.5	14.5	25.0	0.8
B72214S0200K101	7.5	1.9	15.5	4.6	18.5	25.0	0.8
B72220S0200K101	10.0	2.1	21.5	5.1	25.5	25.0	1.0



Leaded varistors

Standard series

Dimensions

Ordering code	$e \pm 1$ mm	$a \pm 1$ mm	b_{\max} mm	s_{\max} mm	h_{\max} mm	l_{\min} mm	$d \pm 0.05$ mm
B72205S0250K101	5.0	1.3	7.0	3.6	8.5	25.0	0.6
B72207S0250K101	5.0	1.3	9.0	3.7	11.0	25.0	0.6
B72210S0250K101	7.5	1.6	12.0	4.2	14.5	25.0	0.8
B72214S0250K101	7.5	1.7	15.5	4.2	18.5	25.0	0.8
B72220S0250K101	10.0	1.8	21.5	4.7	25.5	25.0	1.0
B72205S0300K101	5.0	1.5	7.0	3.6	8.5	25.0	0.6
B72207S0300K101	5.0	1.5	9.0	3.7	11.0	25.0	0.6
B72210S0300K101	7.5	1.7	12.0	4.4	14.5	25.0	0.8
B72214S0300K101	7.5	1.8	15.5	4.4	18.5	25.0	0.8
B72220S0300K101	10.0	2.0	21.5	4.9	25.5	25.0	1.0
B72205S0350K101	5.0	1.6	7.0	3.7	8.5	25.0	0.6
B72207S0350K101	5.0	1.6	9.0	3.9	11.0	25.0	0.6
B72210S0350K101	7.5	1.8	12.0	4.4	14.5	25.0	0.8
B72214S0350K101	7.5	2.0	15.5	4.5	18.5	25.0	0.8
B72220S0350K101	10.0	2.2	21.5	5.1	25.5	25.0	1.0
B72205S0400K101	5.0	1.8	7.0	3.9	8.5	25.0	0.6
B72207S0400K101	5.0	1.8	9.0	4.1	11.0	25.0	0.6
B72210S0400K101	7.5	2.1	12.0	4.8	14.5	25.0	0.8
B72214S0400K101	7.5	2.2	15.5	4.9	18.5	25.0	0.8
B72220S0400K101	10.0	2.4	21.5	5.4	25.5	25.0	1.0
B72205S0500K101	5.0	1.2	7.0	3.3	8.5	25.0	0.6
B72207S0500K101	5.0	1.2	9.0	3.3	11.0	25.0	0.6
B72210S0500K101	7.5	1.4	12.0	3.9	14.5	25.0	0.8
B72214S0500K101	7.5	1.4	15.5	3.9	18.5	25.0	0.8
B72220S0500K101	10.0	1.5	21.5	4.3	25.5	25.0	1.0
B72205S0600K101	5.0	1.2	7.0	3.3	8.5	25.0	0.6
B72207S0600K101	5.0	1.2	9.0	3.3	11.0	25.0	0.6
B72210S0600K101	7.5	1.4	12.0	4.0	14.5	25.0	0.8
B72214S0600K101	7.5	1.5	15.5	4.0	18.5	25.0	0.8
B72220S0600K101	10.0	1.6	21.5	4.4	25.5	25.0	1.0
B72205S0750K101	5.0	1.3	7.0	3.4	8.5	25.0	0.6
B72207S0750K101	5.0	1.3	9.0	3.6	11.0	25.0	0.6
B72210S0750K101	7.5	1.5	12.0	4.2	14.5	25.0	0.8
B72214S0750K101	7.5	1.5	15.5	4.2	18.5	25.0	0.8
B72220S0750K101	10.0	1.6	21.5	4.6	25.5	25.0	1.0

Leaded varistors
Standard series
Dimensions

Ordering code	$e \pm 1$ mm	$a \pm 1$ mm	b_{\max} mm	s_{\max} mm	h_{\max} mm	l_{\min} mm	$d \pm 0.05$ mm
B72205S0950K101	5.0	1.3	7.0	3.4	8.5	25.0	0.6
B72207S0950K101	5.0	1.3	9.0	3.4	11.0	25.0	0.6
B72210S0950K101	7.5	1.5	12.0	4.0	14.5	25.0	0.8
B72214S0950K101	7.5	1.5	15.5	4.0	18.5	25.0	0.8
B72220S0950K101	10.0	1.6	21.5	4.5	25.5	25.0	1.0
B72205S0111K101	5.0	1.5	7.0	3.6	8.5	25.0	0.6
B72207S0111K101	5.0	1.5	9.0	3.6	11.0	25.0	0.6
B72210S0111K101	7.5	1.6	12.0	4.2	14.5	25.0	0.8
B72214S0111K101	7.5	1.7	15.5	4.2	18.5	25.0	0.8
B72220S0111K101	10.0	1.8	21.5	4.6	25.5	25.0	1.0
B72205S0131K101	5.0	1.6	7.0	3.6	8.5	25.0	0.6
B72207S0131K101	5.0	1.6	9.0	3.6	11.0	25.0	0.6
B72210S0131K101	7.5	1.8	12.0	4.2	14.5	25.0	0.8
B72214S0131K101	7.5	1.9	15.5	4.2	18.5	25.0	0.8
B72220S0131K101	10.0	2.0	21.5	4.7	25.5	25.0	1.0
B72205S0141K101	5.0	1.7	7.0	3.7	8.5	25.0	0.6
B72207S0141K101	5.0	1.7	9.0	3.7	11.0	25.0	0.6
B72210S0141K101	7.5	1.9	12.0	4.3	14.5	25.0	0.8
B72214S0141K101	7.5	2.0	15.5	4.3	18.5	25.0	0.8
B72220S0141K101	10.0	2.1	21.5	4.8	25.5	25.0	1.0
B72205S0151K101	5.0	1.8	7.0	3.8	8.5	25.0	0.6
B72207S0151K101	5.0	1.8	9.0	3.8	11.0	25.0	0.6
B72210S0151K101	7.5	2.0	12.0	4.4	14.5	25.0	0.8
B72214S0151K101	7.5	2.1	15.5	4.4	18.5	25.0	0.8
B72220S0151K101	10.0	2.2	21.5	4.9	25.5	25.0	1.0
B72205S0171K101	5.0	2.0	7.0	3.9	8.5	25.0	0.6
B72207S0171K101	5.0	2.0	9.0	4.0	11.0	25.0	0.6
B72210S0171K101	7.5	2.2	12.0	4.6	14.5	25.0	0.8
B72214S0171K101	7.5	2.2	15.5	4.6	18.5	25.0	0.8
B72220S0171K101	10.0	2.3	21.5	5.0	25.5	25.0	1.0
B72205S0231K101	5.0	1.8	7.0	4.0	8.5	25.0	0.6
B72207S0231K101	5.0	1.8	9.0	4.0	11.0	25.0	0.6
B72210S0231K101	7.5	2.0	12.0	4.7	14.5	25.0	0.8
B72214S0231K101	7.5	2.0	15.5	4.7	18.5	25.0	0.8
B72220S0231K101	10.0	2.1	21.5	5.1	25.5	25.0	1.0



Leaded varistors

Standard series

Dimensions

Ordering code	$e \pm 1$ mm	$a \pm 1$ mm	b_{\max} mm	s_{\max} mm	h_{\max} mm	l_{\min} mm	$d \pm 0.05$ mm
B72205S0251K101	5.0	1.8	7.0	4.2	8.5	25.0	0.6
B72207S0251K101	5.0	1.8	9.0	4.2	11.0	25.0	0.6
B72210S0251K101	7.5	2.0	12.0	4.8	14.5	25.0	0.8
B72214S0251K101	7.5	2.0	15.5	4.8	18.5	25.0	0.8
B72220S0251K101	10.0	2.2	21.5	5.3	25.5	25.0	1.0
B72205S0271K101	5.0	2.0	7.0	4.3	8.5	25.0	0.6
B72207S0271K101	5.0	2.0	9.0	4.4	11.0	25.0	0.6
B72210S0271K101	7.5	2.2	12.0	5.0	14.5	25.0	0.8
B72214S0271K101	7.5	2.2	15.5	5.0	18.5	25.0	0.8
B72220S0271K101	10.0	2.3	21.5	5.4	25.5	25.0	1.0
B72205S0301K101	5.0	2.1	7.0	4.5	8.5	25.0	0.6
B72207S0301K101	5.0	2.1	9.0	4.5	11.0	25.0	0.6
B72210S0301K101	7.5	2.3	12.0	5.1	14.5	25.0	0.8
B72214S0301K101	7.5	2.3	15.5	5.2	18.5	25.0	0.8
B72220S0301K101	10.0	2.4	21.5	5.6	25.5	25.0	1.0
B72210S0321K101	7.5	2.4	12.0	5.4	15.0	25.0	0.8
B72214S0321K101	7.5	2.4	15.5	5.4	19.0	25.0	0.8
B72220S0321K101	10.0	2.6	21.5	5.8	25.5	25.0	1.0
B72205S0381K101	5.0	2.5	7.0	5.1	9.0	25.0	0.6
B72207S0381K101	5.0	2.5	9.0	5.2	11.5	25.0	0.6
B72210S0381K101	7.5	2.7	12.0	5.8	15.0	25.0	0.8
B72214S0381K101	7.5	2.7	15.5	5.9	19.0	25.0	0.8
B72220S0381K101	10.0	2.8	21.5	6.3	26.0	25.0	1.0
B72205S0421K101	5.0	2.8	7.0	5.4	9.0	25.0	0.6
B72207S0421K101	5.0	2.8	9.0	5.4	11.5	25.0	0.6
B72210S0421K101	7.5	2.9	12.0	6.1	15.0	25.0	0.8
B72214S0421K101	7.5	2.9	15.5	6.1	19.0	25.0	0.8
B72220S0421K101	10.0	3.1	21.5	6.5	26.0	25.0	1.0
B72205S0441K101	5.0	2.8	7.0	5.5	9.0	25.0	0.6
B72207S0441K101	5.0	2.8	9.0	5.5	11.5	25.0	0.6
B72210S0441K101	7.5	3.0	12.0	6.2	15.0	25.0	0.8
B72214S0441K101	7.5	3.0	15.5	6.3	19.0	25.0	0.8
B72220S0441K101	10.0	3.1	21.5	6.7	26.0	25.0	1.0

Leaded varistors
Standard series
Dimensions

Ordering code	$e \pm 1$ mm	$a \pm 1$ mm	b_{\max} mm	s_{\max} mm	h_{\max} mm	l_{\min} mm	$d \pm 0.05$ mm
B72205S0461K101	5.0	3.0	7.0	5.7	9.0	25.0	0.6
B72207S0461K101	5.0	3.0	9.0	5.7	11.5	25.0	0.6
B72210S0461K101	7.5	3.1	12.0	6.3	15.0	25.0	0.8
B72214S0461K101	7.5	3.1	15.5	6.4	19.0	25.0	0.8
B72220S0461K101	10.0	3.3	21.5	6.8	26.0	25.0	1.0
B72210S0511K101	7.5	3.4	12.0	6.7	15.0	25.0	0.8
B72214S0511K101	7.5	3.4	15.5	6.8	19.0	25.0	0.8
B72220S0511K101	10.0	3.5	21.5	7.1	26.0	25.0	1.0
B72210S0551K101	7.5	3.7	12.0	7.1	15.0	25.0	0.8
B72214S0551K101	7.5	3.7	15.5	7.2	19.0	25.0	0.8
B72220S0551K101	10.0	3.9	21.5	7.5	26.0	25.0	1.0
B72210S0621K101	7.5	4.0	12.0	7.5	15.0	25.0	0.8
B72214S0621K101	7.5	4.0	15.5	7.5	19.0	25.0	0.8
B72220S0621K101	10.0	4.2	21.5	7.9	26.0	25.0	1.0
B72210S0681K101	7.5	4.4	12.0	7.9	15.0	25.0	0.8
B72214S0681K101	7.5	4.4	15.5	8.0	19.0	25.0	0.8
B72220S0681K101	10.0	4.5	21.5	8.4	26.0	25.0	1.0
B72214S0102K101	7.5	6.7	15.5	11.0	20.5	25.0	0.8
B72220S0102K101	10.0	6.9	21.5	11.4	28.5	25.0	1.0



Leaded varistors

Standard series

Reliability data

Test	Test methods/conditions	Requirement
Varistor voltage	The voltage between two terminals with the specified measuring current applied is called V_V (1 mA _{DC} @ 0.2 ... 2 s).	To meet the specified value.
Clamping voltage	The maximum voltage between two terminals with the specified standard impulse current (8/20 μ s) applied.	To meet the specified value.
Max. AC operating voltage	CECC 42 000, test 4.20 1000 h at UCT After having continuously applied the maximum allowable voltage at UCT ± 2 °C for 1000 h, the specimen shall be stored at room temperature and normal humidity for 1 to 2 h. Thereafter, the change of V_V shall be measured.	$ \Delta V/V (1 \text{ mA}) \leq 10\%$
Surge current derating, 8/20 μ s	CECC 42 000, test C 2.1 100 surge currents (8/20 μ s), unipolar, interval 30 s, amplitude corresponding to derating curve for 100 impulses at 20 μ s	$ \Delta V/V (1 \text{ mA}) \leq 10\%$ (measured in direction of surge current) No visible damage
Surge current derating, 2 ms	CECC 42 000, test C 2.1 100 surge currents (2 ms), unipolar, interval 120 s, amplitude corresponding to derating curve for 100 impulses at 2 ms	$ \Delta V/V (1 \text{ mA}) \leq 10\%$ (measured in direction of surge current) No visible damage
Electric strength	CECC 42 000, test 4.7 Metal balls method, 2500 V _{RMS} , 60 s The varistor is placed in a container holding 1.6 \pm 0.2 mm diameter metal balls such that only the terminations of the varistor are protruding. The specified voltage shall be applied between both terminals of the specimen connected together and the electrode inserted between the metal balls.	No breakdown

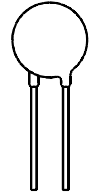
Reliability data

Test	Test methods/conditions	Requirement
Climatic sequence	CECC 42 000, test 4.16 The specimen shall be subjected to: a) dry heat at UCT, 16 h b) damp heat, 1st cycle: 55 °C, 93% r. H., 24 h c) cold, LCT, 2 h d) damp heat, additional 5 cycles: 55 °C/25 °C, 93% r. H., 24 h/cycle. Then the specimen shall be stored at room temperature and normal humidity for 1 to 2 h. Thereafter, the change of V_V shall be measured. Thereafter, insulation resistance R_{ins} shall be measured according to CECC 42 000, test 4.8 at $V = 500$ V.	$ \Delta V/V (1 \text{ mA}) \leq 10\%$ $R_{ins} \geq 1 \text{ M}\Omega$
Fast temperature cycling	IEC 60068-2-14, test Na, LCT/UCT, dwell time 30 min, 5 cycles	$ \Delta V/V (1 \text{ mA}) \leq 5\%$ No visible damage
Damp heat, steady state	The specimen shall be subjected to 40 ± 2 °C, 90 to 95% r. H. for 56 days without load / with 10% of the maximum continuous DC operating voltage V_{DC} . Then stored at room temperature and normal humidity for 1 to 2 h. Thereafter, the change of V_V shall be measured. Thereafter, insulation resistance R_{ins} shall be measured according to CECC 42 000, test 4.8 at $V = 500$ V.	$ \Delta V/V (1 \text{ mA}) \leq 10\%$ $R_{ins} \geq 1 \text{ M}\Omega$
Solderability	IEC 60068-2-20, test Ta, method 1 with modified conditions for lead-free solder alloys: 245 °C, 3 s: After dipping the terminals to a depth of approximately 3 mm from the body in a soldering bath of 245 °C for 3 s, the terminals shall be visually examined.	The inspection shall be carried out under adequate light with normal eyesight or with the assistance of a magnifier capable of giving a magnification of 4 to 10 times. The dipped surface shall be covered with a smooth and bright solder coating with no more than small amounts of scattered imperfections such as pinholes or un-wetted or de-wetted areas. These imperfections shall not be concentrated in one area.

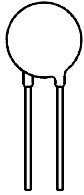

Leaded varistors

Standard series

Reliability data

Test	Test methods/conditions	Requirement
Resistance to soldering heat	<p>IEC 60068-2-20, test Tb, method 1A, 260 °C, 10 s:</p> <p>Each lead shall be dipped into a solder bath having a temperature of 260 ± 5 °C to a point 2.0 to 2.5 mm from the body of the specimen, be held there for 10 ± 1 s and then be stored at room temperature and normal humidity for 1 to 2 h. The change of V_v shall be measured and the specimen shall be visually examined.</p>	<p>$\Delta V/V (1 \text{ mA}) \leq 5\%$</p> <p>No visible damage</p>
Tensile strength	<p>IEC 60068-2-21, test Ua1</p> <p>After gradually applying the force specified below and keeping the unit fixed for 10 s, the terminal shall be visually examined for any damage.</p> <p>Force for wire diameter: 0.6 mm = 10 N 0.8 mm = 10 N 1.0 mm = 20 N</p>	<p>$\Delta V/V (1 \text{ mA}) \leq 5\%$</p> <p>No break of solder joint, no wire break</p>
Vibration	<p>IEC 60068-2, test Fc</p> <p>Frequency range: 10 ... 55 Hz Amplitude: 0.75 mm or 98 m/s² Duration: 6 h (3 · 2 h) Pulse: sine wave</p> <p>After repeatedly applying a single harmonic vibration according to the table above.</p> <p>The change of V_v shall be measured and the specimen shall be visually examined.</p>	<p>$\Delta V/V (1 \text{ mA}) \leq 5\%$</p> <p>No visible damage</p>
Bump	<p>IEC 60068-2-29, test Eb</p> <p>Pulse duration: 6 ms Max. acceleration: 400 m/s² Number of bumps: 4000 Pulse: half sine</p>	<p>$\Delta V/V (1 \text{ mA}) \leq 5\%$</p> <p>No visible damage</p>
Flammability	<p>IEC 60695-2-2 (needle flame test)</p> <p>Severity: vertical 10 s</p>	<p>5 s max.</p>

Note:

UCT = Upper category temperature / LCT = Lower category temperature / R_{ins} = Insulation resistance to CECC 42 000, test 4.8



Leaded varistors
Standard series

v/i characteristics

$v = f(i)$ – for explanation of the characteristics refer to “General technical information”, 1.6.3

A = Leakage current { for worst-case
B = Protection level { varistor tolerances



SIOV-S05 ...



Leaded varistors

Standard series

v/i characteristics

$v = f(i)$ – for explanation of the characteristics refer to “General technical information”, 1.6.3

A = Leakage current
B = Protection level

for worst-case varistor tolerances



SIOV-S07 ...

Please read *Cautions and warnings* and *Important notes* at the end of this document.



Leaded varistors
Standard series

v/i characteristics

$v = f(i)$ – for explanation of the characteristics refer to “General technical information”, 1.6.3

A = Leakage current { for worst-case
B = Protection level } varistor tolerances

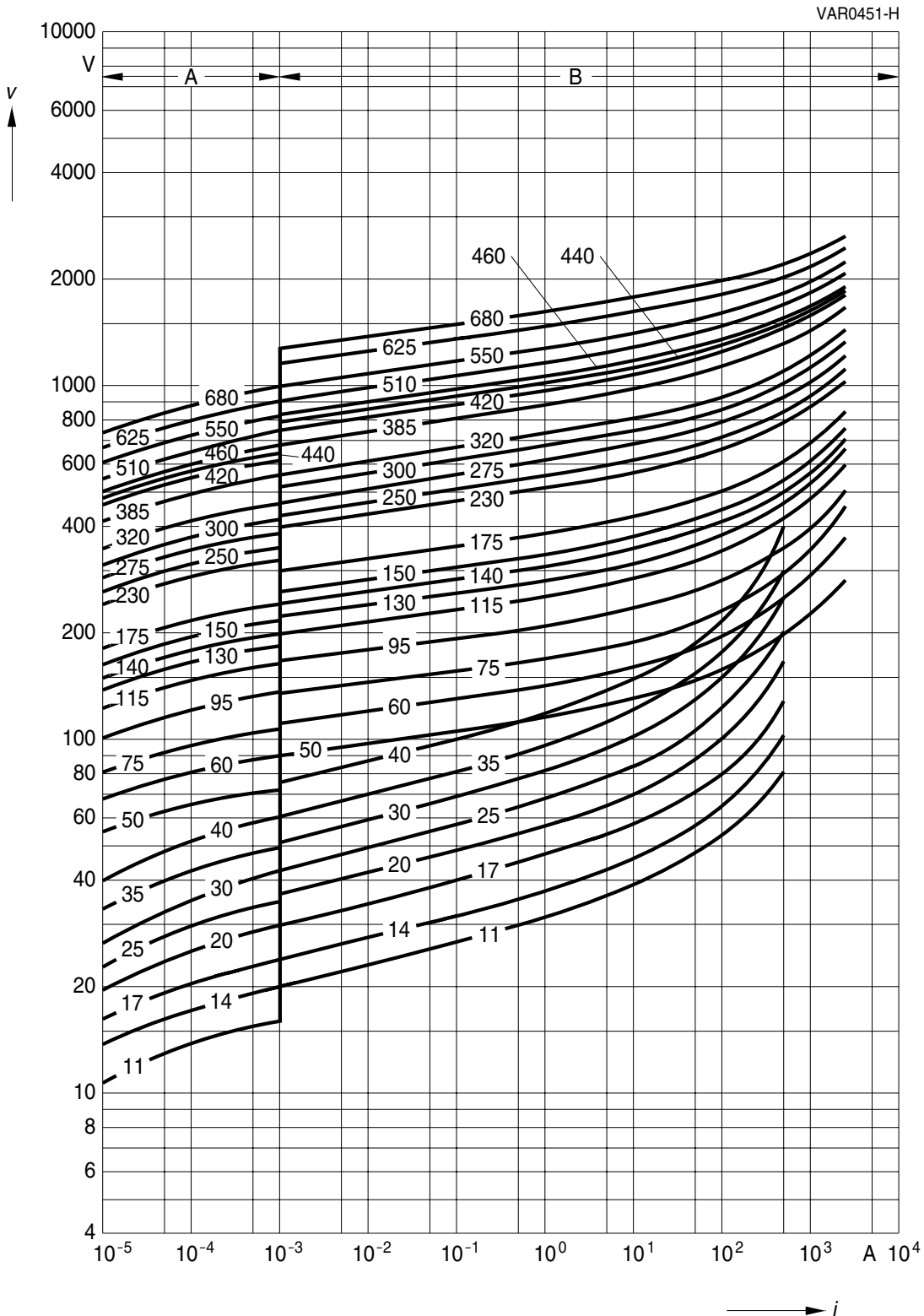

SIOV-S10 ...

Please read *Cautions and warnings* and *Important notes* at the end of this document.



Leaded varistors

Standard series

v/i characteristics

$v = f(i)$ – for explanation of the characteristics refer to “General technical information”, 1.6.3

A = Leakage current
 B = Protection level { for worst-case varistor tolerances



SIOV-S14 ...

Please read *Cautions and warnings* and *Important notes* at the end of this document.



Leaded varistors
Standard series

v/i characteristics

$v = f(i)$ – for explanation of the characteristics refer to “General technical information”, 1.6.3

A = Leakage current { for worst-case
B = Protection level } varistor tolerances



SIOV-S20 ...

Please read *Cautions and warnings* and *Important notes* at the end of this document.



Leaded varistors

Standard series

Derating curves

Maximum surge current $i_{max} = f(t_r, \text{pulse train})$

For explanation of the derating curves refer to "General technical information", section 1.8.1

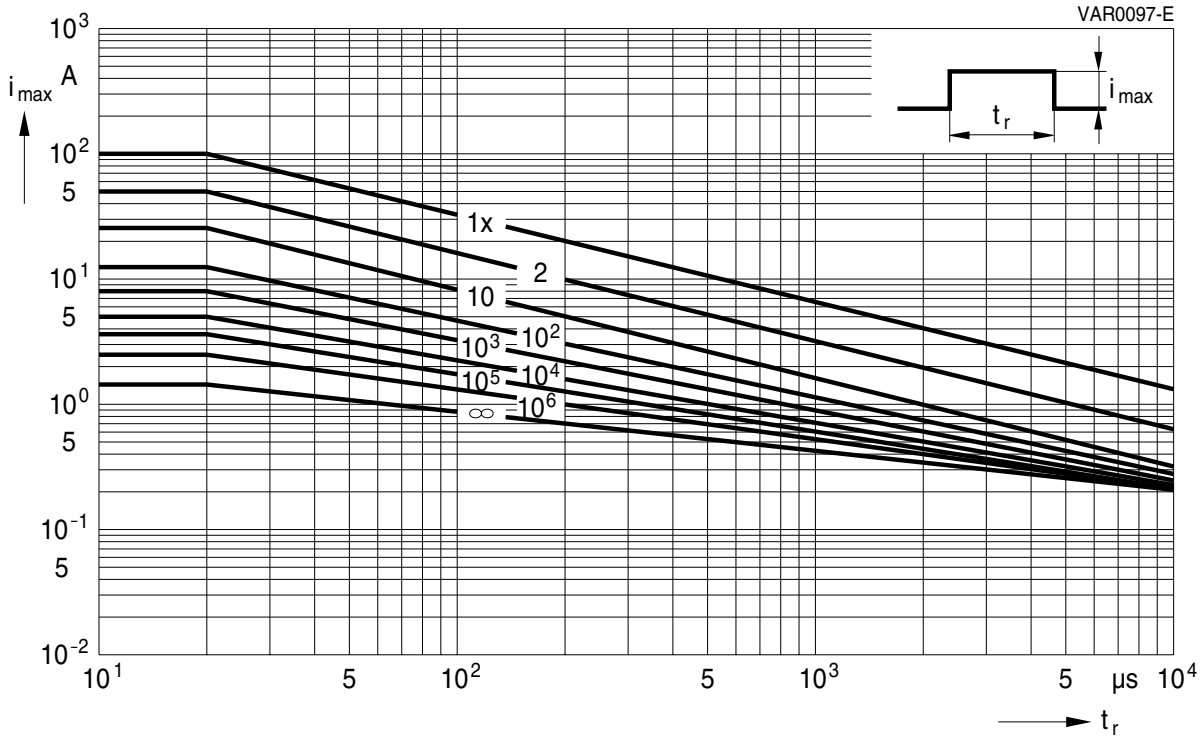

SIOV-S05K11 ... K40

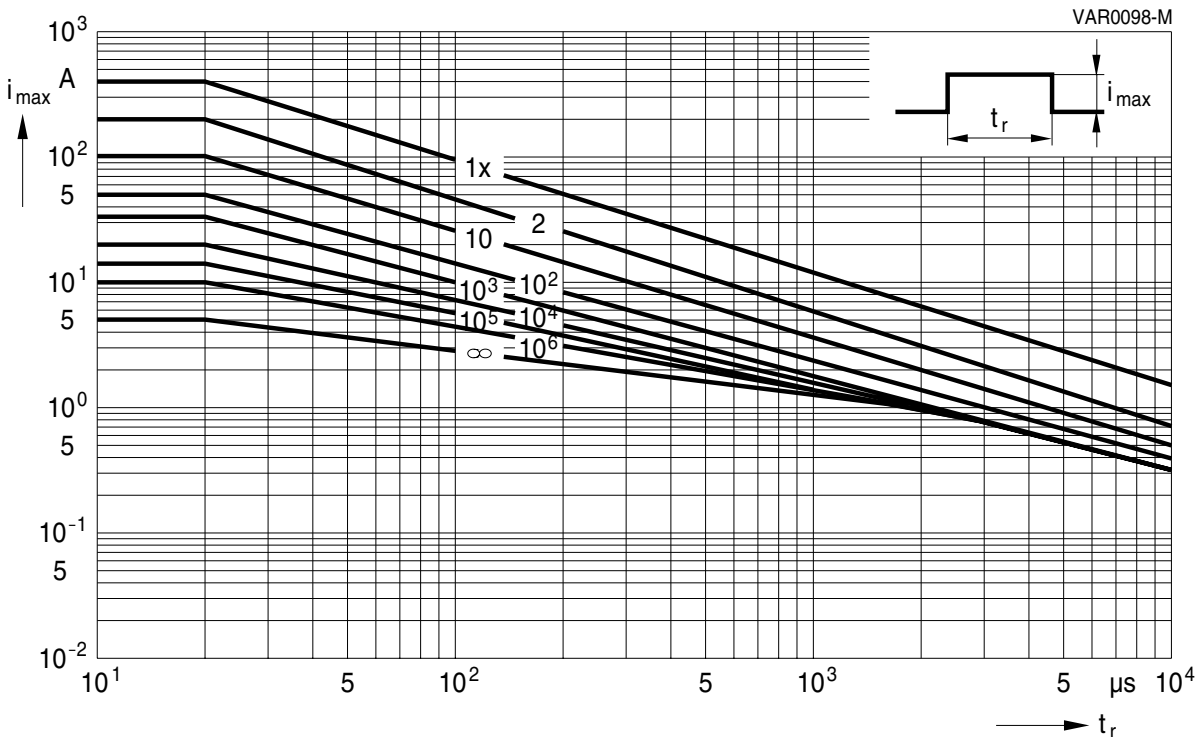

SIOV-S05K50 ... K460



Leaded varistors
Standard series

Derating curves

Maximum surge current $i_{max} = f(t_r, \text{pulse train})$

For explanation of the derating curves refer to "General technical information", section 1.8.1



SIOV-S07K11 ... K40



SIOV-S07K50 ... K460



Leaded varistors

Standard series

Derating curves

Maximum surge current $i_{\max} = f(t_r, \text{pulse train})$

For explanation of the derating curves refer to "General technical information", section 1.8.1



SIOV-S10K11 ... K40



SIOV-S10K50 ... K320



Leaded varistors
Standard series

Derating curves

Maximum surge current $i_{max} = f(t_r, \text{pulse train})$

For explanation of the derating curves refer to "General technical information", section 1.8.1



SIOV-S10K385 ... K680

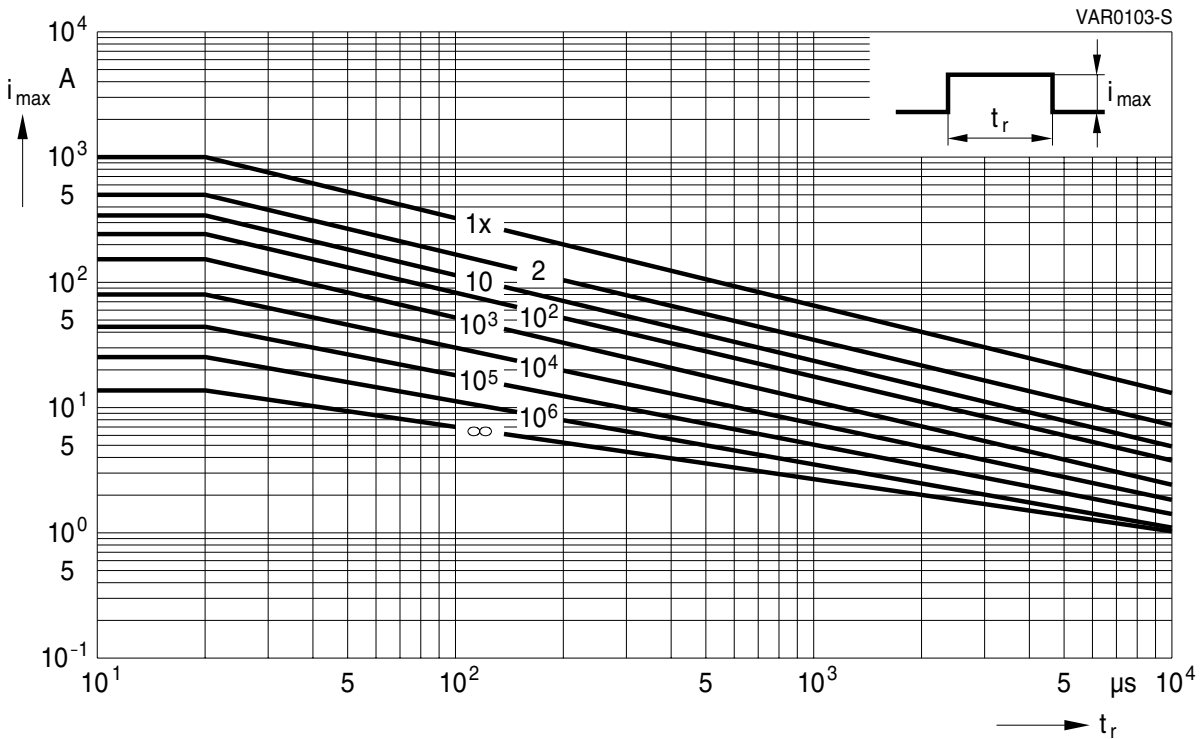

SIOV-S14K11 ... K40



Leaded varistors

Standard series

Derating curves

Maximum surge current $i_{\max} = f(t_r, \text{pulse train})$

For explanation of the derating curves refer to "General technical information", section 1.8.1

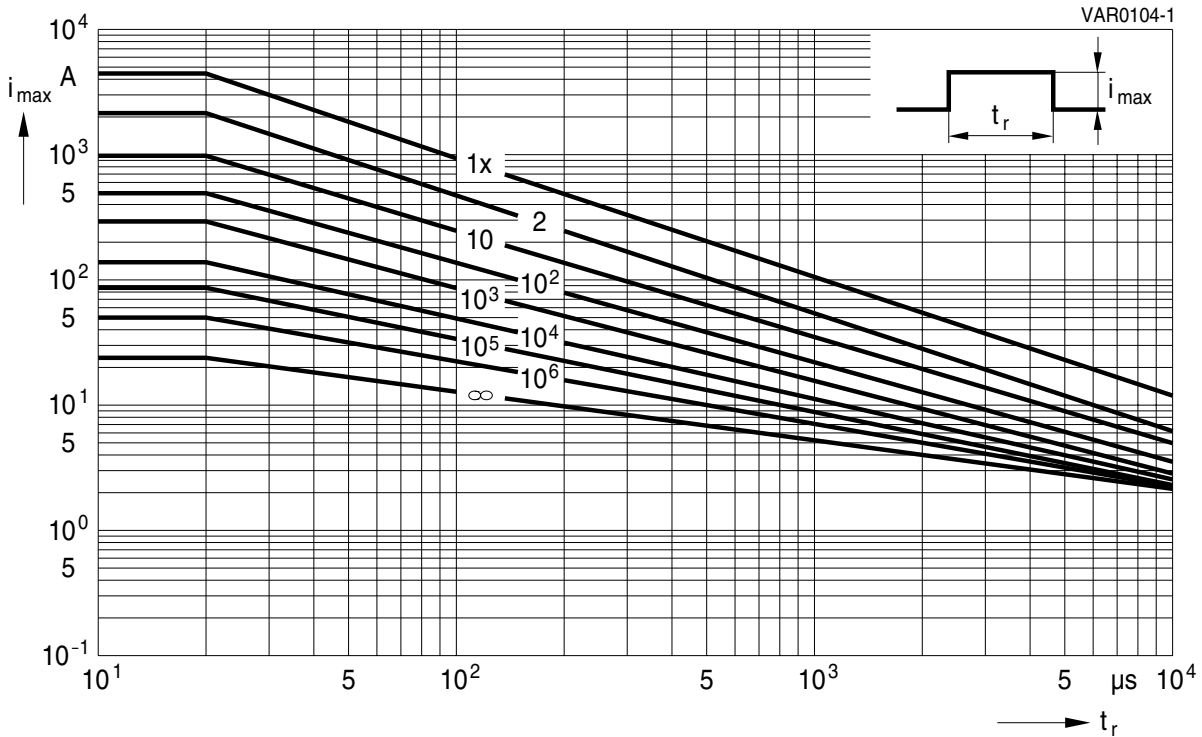

SIOV-S14K50 ... K320

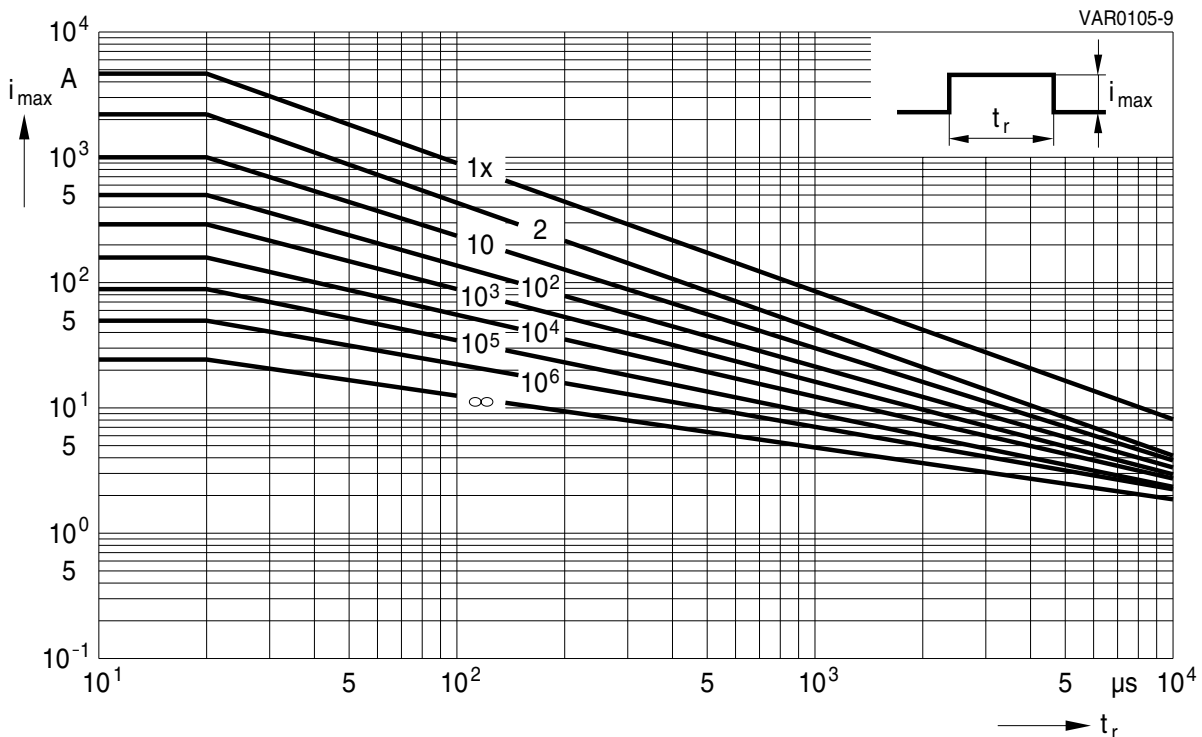

SIOV-S14K385 ... K1000



Leaded varistors
Standard series

Derating curves

Maximum surge current $i_{max} = f(t_r, \text{pulse train})$

For explanation of the derating curves refer to "General technical information", section 1.8.1

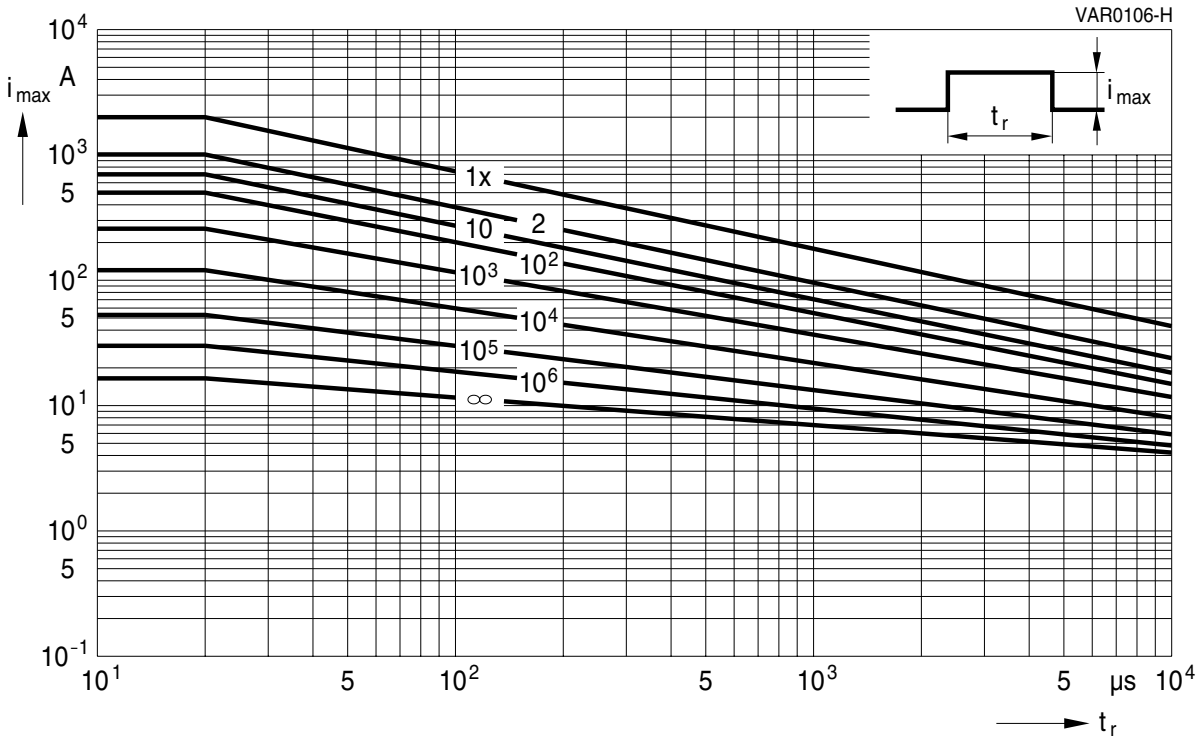

SIOV-S20K11 ... K40

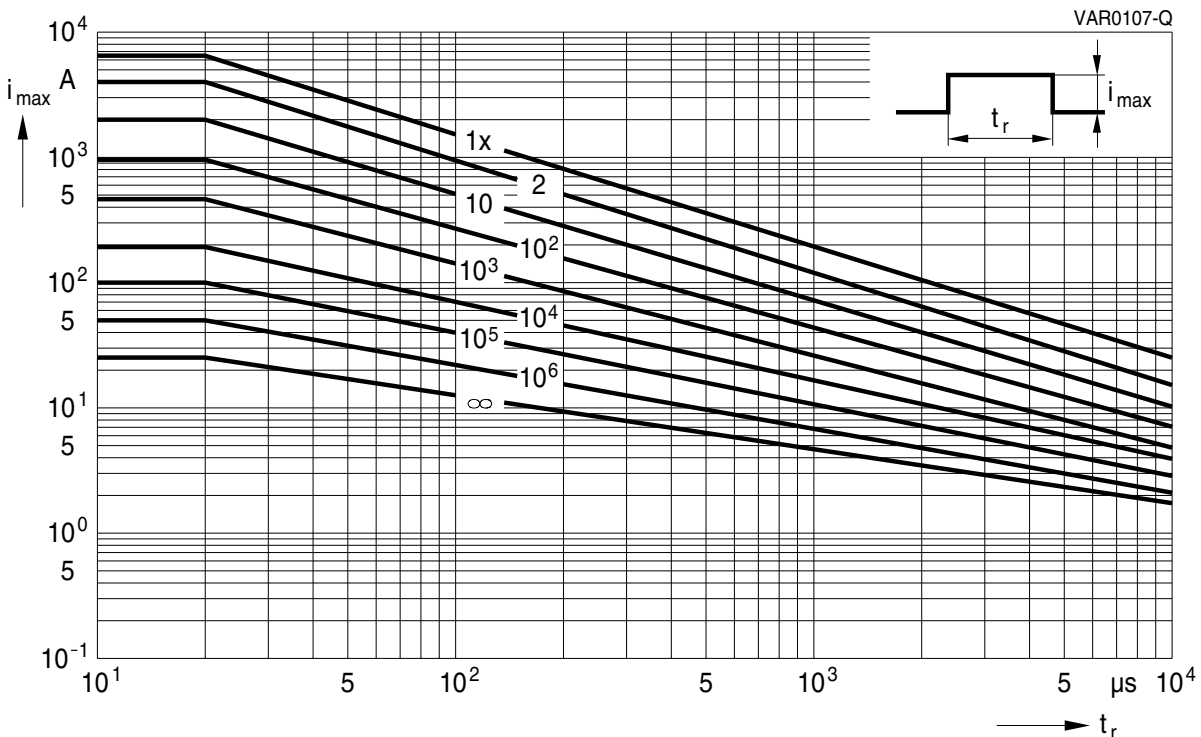

SIOV-S20K50 ... K115



Leaded varistors

Standard series

Derating curves

Maximum surge current $i_{\max} = f(t_r, \text{pulse train})$

For explanation of the derating curves refer to "General technical information", section 1.8.1

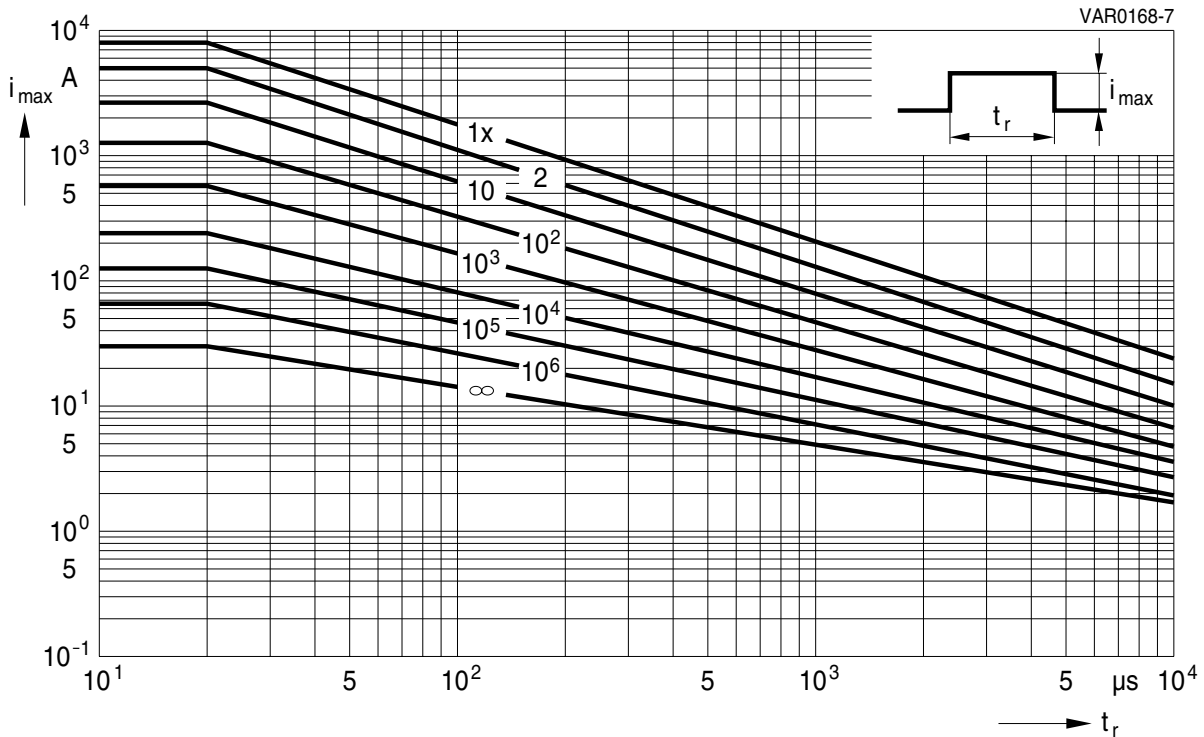

SIOV-S20K130 ... K320

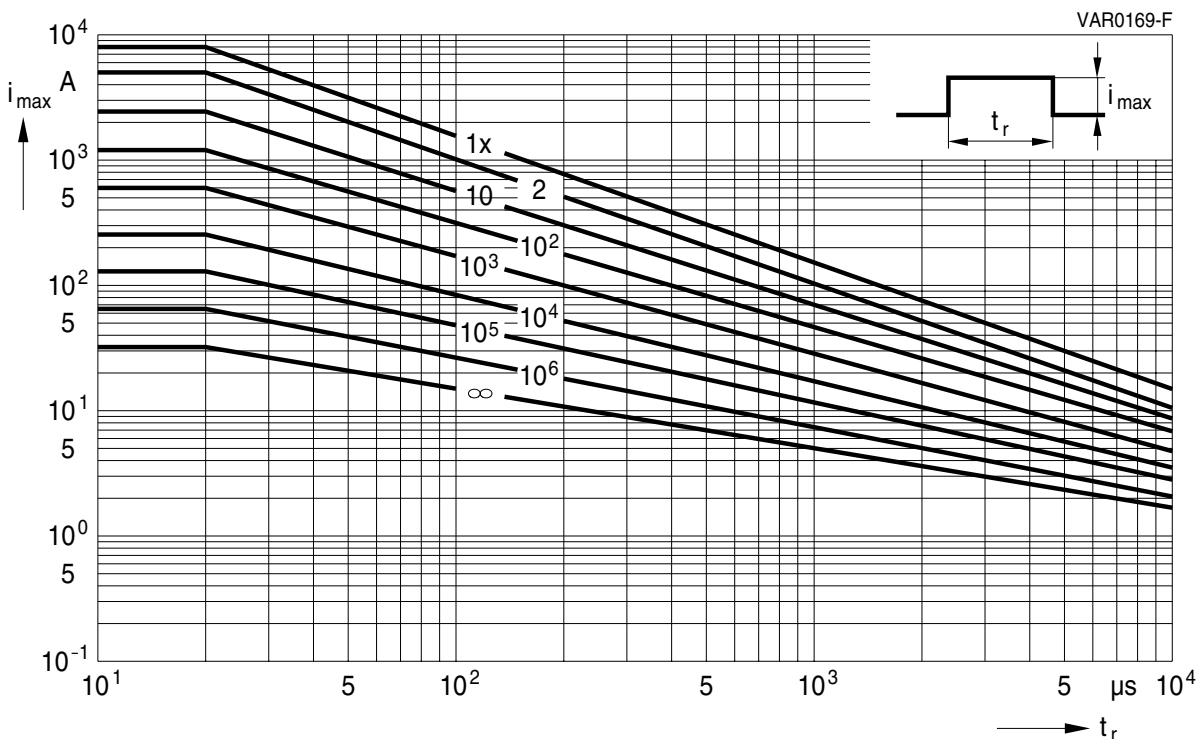

SIOV-S20K385 ... K460



Leaded varistors
Standard series

Derating curves

Maximum surge current $i_{max} = f(t_r, \text{pulse train})$

For explanation of the derating curves refer to "General technical information", section 1.8.1

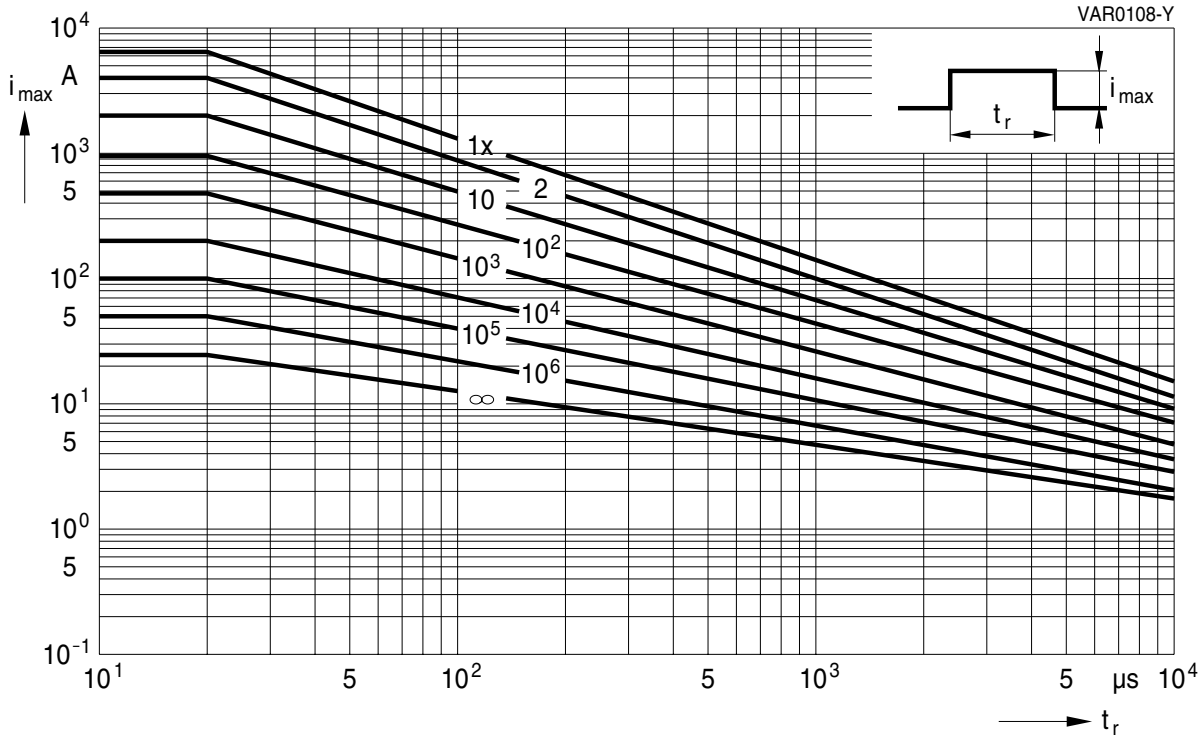

SIOV-S20K510 ... K1000

Cautions and warnings

General

1. EPCOS metal oxide varistors (SIOVs) are designed for specific applications and should not be used for purposes not identified in our specifications, application notes and data books unless otherwise agreed with EPCOS during the design-in-phase.
2. Ensure suitability of SIOVs through reliability testing during the design-in phase. SIOVs should be evaluated taking into consideration worst-case conditions.
3. For applications of SIOVs in line-to-ground circuits based on various international and local standards there are restrictions existing or additional safety measures required.

Storage

1. Store SIOVs only in original packaging. Do not open the package before storage.
2. Storage conditions in original packaging:
Storage temperature: $-25\text{ °C} \dots +45\text{ °C}$
Relative humidity: $<75\%$ annual average,
 $<95\%$ on maximum 30 days a year.
Dew precipitation: Is to be avoided.
3. Avoid contamination of an SIOV's surface during storage, handling and processing.
4. Avoid storage of SIOVs in harmful environments that can affect the function during long-term operation (examples given under operation precautions).
5. The SIOV type series should be soldered within the time specified:
SIOV-S, -Q, -LS 24 months
ETFV and SFS types 12 months.

Handling

1. SIOVs must not be dropped.
2. Components must not be touched with bare hands. Gloves are recommended.
3. Avoid contamination of the surface of SIOV electrodes during handling, be careful of the sharp edge of SIOV electrodes.

Soldering (where applicable)

1. Use rosin-type flux or non-activated flux.
2. Insufficient preheating may cause ceramic cracks.
3. Rapid cooling by dipping in solvent is not recommended.
4. Complete removal of flux is recommended.

Leaded varistors

Standard series

Mounting

1. Potting, sealing or adhesive compounds can produce chemical reactions in the SIOV ceramic that will degrade the component's electrical characteristics.
2. Overloading SIOVs may result in ruptured packages and expulsion of hot materials. For this reason SIOVs should be physically shielded from adjacent components.

Operation

1. Use SIOVs only within the specified temperature operating range.
2. Use SIOVs only within the specified voltage and current ranges.
3. Environmental conditions must not harm SIOVs. Use SIOVs only in normal atmospheric conditions. Avoid use in the presence of deoxidizing gases (chlorine gas, hydrogen sulfide gas, ammonia gas, sulfuric acid gas, etc), corrosive agents, humid or salty conditions. Avoid contact with any liquids and solvents.

Important notes

The following applies to all products named in this publication:

1. Some parts of this publication contain **statements about the suitability of our products for certain areas of application**. These statements are based on our knowledge of typical requirements that are often placed on our products in the areas of application concerned. We nevertheless expressly point out **that such statements cannot be regarded as binding statements about the suitability of our products for a particular customer application**. As a rule, EPCOS is either unfamiliar with individual customer applications or less familiar with them than the customers themselves. For these reasons, it is always ultimately incumbent on the customer to check and decide whether an EPCOS product with the properties described in the product specification is suitable for use in a particular customer application.
2. We also point out that **in individual cases, a malfunction of passive electronic components or failure before the end of their usual service life cannot be completely ruled out in the current state of the art, even if they are operated as specified**. In customer applications requiring a very high level of operational safety and especially in customer applications in which the malfunction or failure of a passive electronic component could endanger human life or health (e.g. in accident prevention or life-saving systems), it must therefore be ensured by means of suitable design of the customer application or other action taken by the customer (e.g. installation of protective circuitry or redundancy) that no injury or damage is sustained by third parties in the event of malfunction or failure of a passive electronic component.
3. **The warnings, cautions and product-specific notes must be observed.**
4. In order to satisfy certain technical requirements, **some of the products described in this publication may contain substances subject to restrictions in certain jurisdictions (e.g. because they are classed as hazardous)**. Useful information on this will be found in our Material Data Sheets on the Internet (www.epcos.com/material). Should you have any more detailed questions, please contact our sales offices.
5. We constantly strive to improve our products. Consequently, **the products described in this publication may change from time to time**. The same is true of the corresponding product specifications. Please check therefore to what extent product descriptions and specifications contained in this publication are still applicable before or when you place an order. We also **reserve the right to discontinue production and delivery of products**. Consequently, we cannot guarantee that all products named in this publication will always be available. The aforementioned does not apply in the case of individual agreements deviating from the foregoing for customer-specific products.
6. Unless otherwise agreed in individual contracts, **all orders are subject to the current version of the “General Terms of Delivery for Products and Services in the Electrical Industry” published by the German Electrical and Electronics Industry Association (ZVEI)**.
7. The trade names EPCOS, BAOKE, Alu-X, CeraDiode, CSSP, DSSP, MiniBlue, MKK, MLSC, MotorCap, PCC, PhaseCap, PhaseMod, SIFERRIT, SIFI, SIKOREL, SilverCap, SIMDAD, SIMID, SineFormer, SIOV, SIP5D, SIP5K, ThermoFuse, WindCap are **trademarks registered or pending** in Europe and in other countries. Further information will be found on the Internet at www.epcos.com/trademarks.