

GX-F/H SERIES

- FIBER SENSORS
- LASER SENSORS
- PHOTOELECTRIC SENSORS
- MICRO PHOTOELECTRIC SENSORS
- AREA SENSORS
- SAFETY COMPONENTS
- PRESSURE SENSORS
- INDUCTIVE PROXIMITY SENSORS**
- PARTICULAR USE SENSORS
- SENSOR OPTIONS
- WIRE-SAVING SYSTEMS
- MEASUREMENT SENSORS
- STATIC CONTROL DEVICES
- LASER MARKERS

Related Information	General terms and conditions.....P.1	Sensor selection guide.....P.11~ / P.647~
	Glossary of terms..... P.1009~	General precautions..... P.1012~



Industry No. 1* in stable sensing

* Based on research conducted by SUNX as of August 2007 among equivalent rectangular inductive sensors.

Can be installed with ample space

This sensor has the longest stable sensing range among the same level of rectangular inductive proximity sensors in the industry. It is easy to install the sensor.

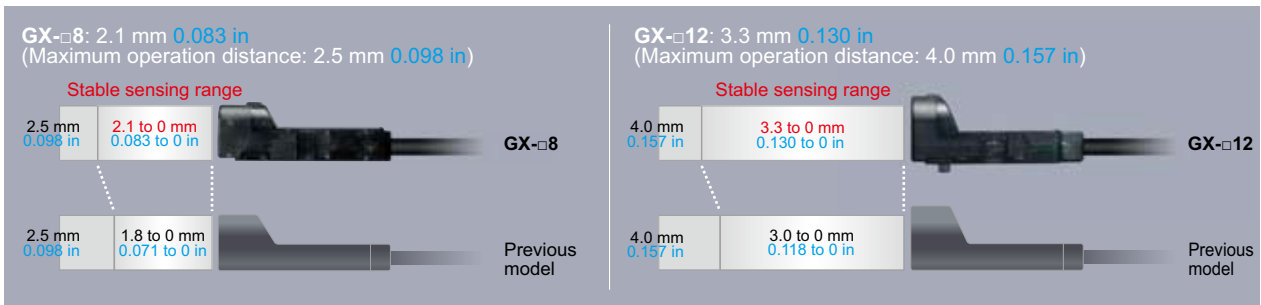

Variation at the maximum operation distance is within ±8%

Thorough adjustment and control of sensing sensitivity greatly reduces individual sensor differences and variations.

The work of adjusting sensor positions when using multiple sensors and when sensors have been replaced is much easier.

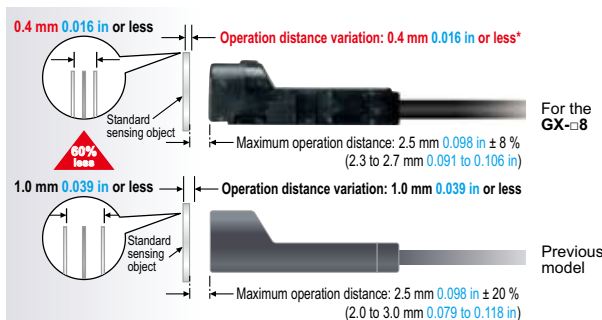

* Not including temperature characteristics.
GX-12 has a variation of 0.64 mm (0.025 in) or less for a maximum operation distance of 4 mm (0.158 in)

Temperature characteristics vary within ±8%

Components such as the sensor coil and core and product design have been totally revised to provide excellent temperature characteristics. Stable sensing can be obtained regardless of the time of day or the yearly season.

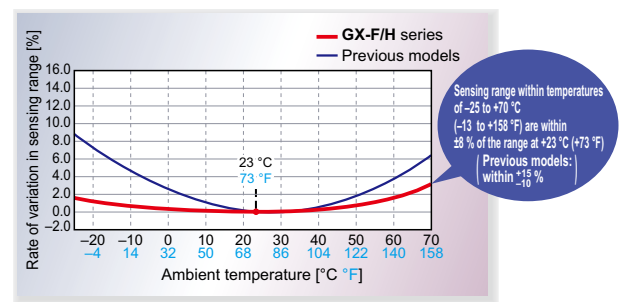

* Typical

 ORDER GUIDE P.651	SPECIFICATIONS P.652~	I/O CIRCUIT DIAGRAMS P.654	SENSING CHARACTERISTICS P.654	PRECAUTIONS FOR PROPER USE P.655	DIMENSIONS P.656
---	--------------------------	-------------------------------	----------------------------------	-------------------------------------	---------------------

APPLICATIONS

Muting control of light curtains

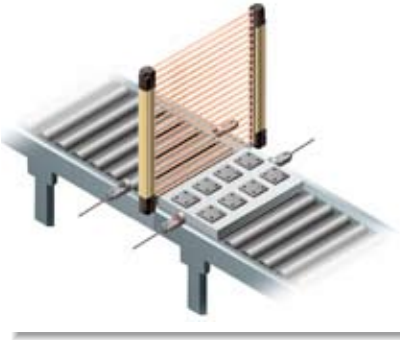

Positioning processing equipment



Positioning metal pallets

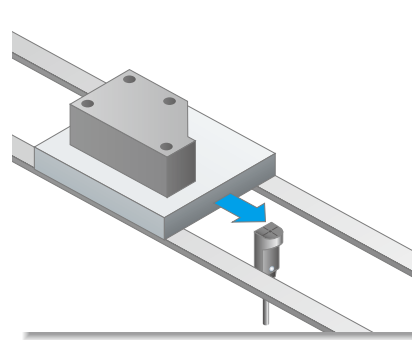

FIBER SENSORS

LASER SENSORS

PHOTOELECTRIC SENSORS

MICRO PHOTOELECTRIC SENSORS

AREA SENSORS

SAFETY COMPONENTS

PRESSURE SENSORS

INDUCTIVE PROXIMITY SENSORS

PARTICULAR USE SENSORS

SENSOR OPTIONS

WIRE-SAVING SYSTEMS

MEASUREMENT SENSORS

STATIC CONTROL DEVICES

LASER MARKERS

ENVIRONMENTAL RESISTANCE

10 times the durability! (Compared to previous models)

The new integrated construction method used provides shock resistance of 10,000 m/s² (approx. 1,000 G in X, Y and Z directions for three times each), and vibration resistance clears durability tests of between 10 and 500 Hz (3mm 0.118 in amplitude in X, Y and Z directions for 2 hours each). In addition, resistance to impulse noise is approx. three times greater than for previous models.

Checking up / down operation of compact molding equipment

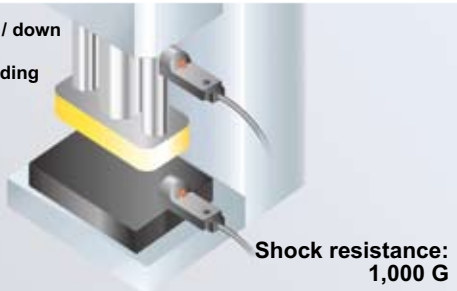

Shock resistance: 1,000 G

Sensing presence of metallic objects on a part feeder

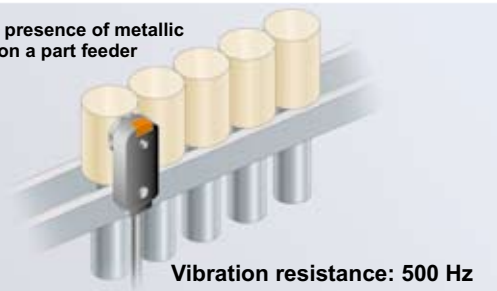

Vibration resistance: 500 Hz

Highly resistant to water or oil!
IP68g* protective construction

The new integrated construction method used improves environmental resistance performance. The IP68g prevents damage to the sensor by stopping water and oil getting inside.

* For details, refer to the "Specifications" (p.652~)



FUNCTIONS

Indicators are easy to see over a wide field of view

A prism with a wide field of view has been developed. This has greatly improved the visibility of the operation indicators.

GX-H□



GX-F□



Selection Guide

Amplifier Built-in

GX-F/H

GXL

GL

GX-U / GX-FU / GX-N

GX

Amplifier-separated

GA-311 / GH

Other

Products

MOUNTING

Tightening strength increased with no damage!

A metal sleeve has been inserted. It is possible to tighten up to 0.7 N·m*.

* Maximum tightening torque for M3 screw.

Tightening torque: 0.7 N·m

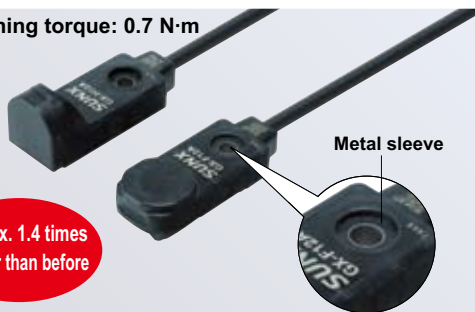

Approx. 1.4 times greater than before

Metal sleeve

Conductor thickness doubled to make wiring much easier! (GX- 8 only)

The conductor's thickness was doubled for the GX- 8. This makes it easier to handle and perform crimping work on the cables. In addition, the tensile strength of the crimping area has become higher.

0.08mm²
Previous model

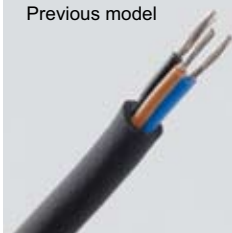

0.15mm²
GX-□8



Conductor thickness approx. 2 times greater

ORDER GUIDE**GX-8 type**

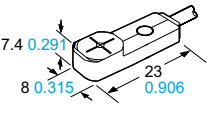
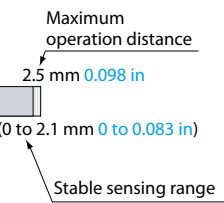
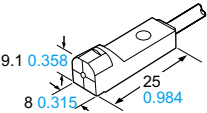
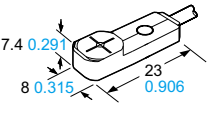
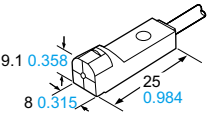
Type	Appearance (mm in)	Sensing range (Note 1)	Model No. (Note 2)	Output	Output operation
NPN output	Front sensing 		GX-F8A	NPN open-collector transistor	Normally open
			GX-F8AI		Normally closed
			GX-F8B		Normally open
	GX-F8BI		Normally closed		
	GX-H8A		Normally open		
	GX-H8AI		Normally closed		
Top sensing 	GX-F8A-P	Normally open			
	GX-F8AI-P	Normally closed			
	GX-F8B-P	Normally open			
PNP output	Front sensing 		GX-F8A-P	PNP open-collector transistor	Normally open
			GX-F8AI-P		Normally closed
			GX-F8B-P		Normally open
	GX-H8A-P		Normally open		
	GX-H8AI-P		Normally closed		
	GX-H8B-P		Normally closed		
Top sensing 	GX-H8B-P	Normally open			
	GX-H8BI-P	Normally closed			
	GX-H8BI-P	Normally closed			

- Notes: 1) The maximum operation distance stands for the maximum distance for which the sensor can detect the standard sensing object. The stable sensing range stands for the sensing range for which the sensor can stably detect the standard sensing object even if there is an ambient temperature drift and/or supply voltage fluctuation.
- 2) "1" in the model No. indicates a different frequency type.

GX-12 type

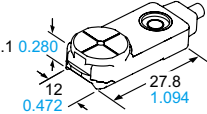
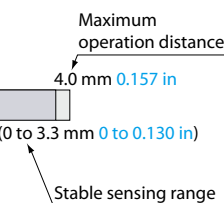
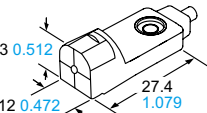
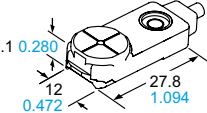
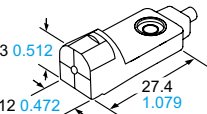
Type	Appearance (mm in)	Sensing range (Note 1)	Model No. (Note 2)	Output	Output operation
NPN output	Front sensing 		GX-F12A	NPN open-collector transistor	Normally open
			GX-F12AI		Normally closed
			GX-F12B		Normally open
	GX-F12BI		Normally closed		
	GX-H12A		Normally open		
	GX-H12AI		Normally closed		
Top sensing 	GX-F12A-P	Normally open			
	GX-F12AI-P	Normally closed			
	GX-F12B-P	Normally open			
PNP output	Front sensing 		GX-F12A-P	PNP open-collector transistor	Normally open
			GX-F12AI-P		Normally closed
			GX-F12BI-P		Normally open
	GX-H12A-P		Normally open		
	GX-H12AI-P		Normally closed		
	GX-H12B-P		Normally closed		
Top sensing 	GX-H12B-P	Normally open			
	GX-H12BI-P	Normally closed			
	GX-H12BI-P	Normally closed			

- Notes: 1) The maximum operation distance stands for the maximum distance for which the sensor can detect the standard sensing object. The stable sensing range stands for the sensing range for which the sensor can stably detect the standard sensing object even if there is an ambient temperature drift and/or supply voltage fluctuation.
- 2) "1" in the model No. indicates a different frequency type.

OPTIONS

Designation	Model No.	Description
Sensor mounting bracket	MS-GXL8-4	Mounting bracket for GX-8 type

Sensor mounting bracket

MS-GXL8-4

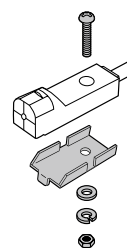

1 pc. each of M3 (length: 12 mm 0.472 in) truss head screw, nut, spring washer and plain washer is attached.

SPECIFICATIONS

GX-8 type

Item	Model No. (Note 2)	Type	NPN output		PNP output	
		Front sensing	GX-F8A(I)	GX-F8B(I)	GX-F8A(I)-P	GX-F8B(I)-P
		Top sensing	GX-H8A(I)	GX-H8B(I)	GX-H8A(I)-P	GX-H8B(I)-P
Max. operation distance (Note 3)		2.5 mm 0.098 in ± 8 %				
Stable sensing range (Note 3)		0 to 2.1 mm 0 to 0.083 in				
Standard sensing object		Iron sheet 15 × 15 × t 1 mm 0.591 × 0.591 × t 0.039 in				
Hysteresis		20 % or less of operation distance (with standard sensing object)				
Repeatability		Along sensing axis, perpendicular to sensing axis: 0.04 mm 0.002 in or less				
Supply voltage		12 to 24 V DC ⁺¹⁰ ₋₁₅ % Ripple P-P 10 % or less				
Current consumption		15 mA or less				
Output		NPN open-collector transistor <ul style="list-style-type: none"> Maximum sink current: 100 mA Applied voltage: 30 V DC or less (between output and 0 V) Residual voltage: 1 V or less (at 100 mA sink current) 0.4 V or less (at 16 mA sink current) 		PNP open-collector transistor <ul style="list-style-type: none"> Maximum source current: 100 mA Applied voltage: 30 V DC or less (between output and +V) Residual voltage: 1 V or less (at 100 mA source current) 0.4 V or less (at 16 mA source current) 		
Utilization category		DC-12 or DC-13				
Output operation		Normally open	Normally closed	Normally open	Normally closed	
Max. response frequency		500 Hz				
Operation indicator		Orange LED (lights up when the output is ON)				
Environmental resistance	Pollution degree	3 (Industrial environment)				
	Protection	IP68 (IEC), IP68g (JEM) (Refer to p.1010 for details of standards.) (Note 4, 5)				
	Ambient temperature	-25 to +70 °C -13 to +158 °F, Storage: -40 to +85 °C -40 to +185 °F				
	Ambient humidity	45 to 85 % RH, Storage: 35 to 95 % RH				
	EMC	EN 60947-5-2				
	Voltage withstandability	1,000 V AC for one min. between all supply terminals connected together and enclosure				
	Insulation resistance	50 MΩ, or more, with 500 V DC megger between all supply terminals connected together and enclosure				
	Vibration resistance	10 to 500 Hz frequency, 3 mm 0.118 in amplitude in X, Y and Z directions for two hours each				
Shock resistance	10,000 m/s ² acceleration (1,000 G approx.) in X, Y and Z directions for three times each					
Sensing range variation	Temperature characteristics	Over ambient temperature range -25 to +70 °C -13 to +158 °F: Within ± 8 % of sensing range at +23 °C +73.4 °F				
	Voltage characteristics	Within ± 2 % for ⁺¹⁰ ₋₁₅ % fluctuation of the supply voltage				
Material		Enclosure: PBT, Indicator part: Polyester				
Cable		0.15 mm ² 3-core oil, heat and cold resistant cabtyre cable, 1 m 3.281 ft long				
Cable extension		Extension up to total 100 m 328.084 ft is possible with 0.3 mm ² , or more, cable.				
Net weight		Front sensing type: 15 g approx., Top sensing type: 20 g approx..				

Notes: 1) Where measurement conditions have not been specified precisely, the conditions used were an ambient temperature of +23 °C +73.4 °F.

2) "I" in the model No. indicates a different frequency type.

3) The maximum operation distance stands for the maximum distance for which the sensor can detect the standard sensing object.

The stable sensing range stands for the sensing range for which the sensor can stably detect the standard sensing object even if there is an ambient temperature drift and/or supply voltage fluctuation.

4) SUNX's IP68 test method

① Immerse at 0 m below 0 °C +32 °F water surface and leave for 30 min. Then, immerse at 0 m below +70 °C +158 °F water surface and leave for 30 min.

② Regard the heat shock test in ④ one cycle and perform 20 cycles.

③ Leave in water at a depth of 1 m 3.281 ft in water for 500 hours.

④ After tests ① to ③ insulation resistance, voltage withstandability, current consumption, and sensing ranges must meet the standard values.

5) If using the sensor in an environment where cutting oil droplets splatter, the sensor may deteriorate due to added substances in the oil.

FIBER SENSORS

LASER SENSORS

PHOTO-ELECTRIC SENSORS

MICRO PHOTO-ELECTRIC SENSORS

AREA SENSORS

SAFETY COMPONENTS

PRESSURE SENSORS

INDUCTIVE PROXIMITY SENSORS

PARTICULAR USE SENSORS

SENSOR OPTIONS

WIRE-SAVING SYSTEMS

MEASUREMENT SENSORS

STATIC CONTROL DEVICES

LASER MARKERS

Selection Guide

Amplifier Built-in

GX-F/H

GXL

GL

GX-U / GX-FU / GX-N

GX

Amplifier-separated

GA-311 / GH

Other Products

SPECIFICATIONS

GX-12 type

Item	Model No. (Note 2)	Type	NPN output		PNP output		
		Front sensing	GX-F12A(I)	GX-F12B(I)	GX-F12A(I)-P	GX-F12B(I)-P	
		Top sensing	GX-H12A(I)	GX-H12B(I)	GX-H12A(I)-P	GX-H12B(I)-P	
Max. operation distance (Note 3)		4.0 mm 0.158 in ± 8 %					
Stable sensing range (Note 3)		0 to 3.3 mm 0 to 0.130 in					
Standard sensing object		Iron sheet 20 × 20 × t 1 mm 0.787 × 0.787 × t 0.039 in					
Hysteresis		20 % or less of operation distance (with standard sensing object)					
Repeatability		Along sensing axis, perpendicular to sensing axis: 0.04 mm 0.002 in or less					
Supply voltage		12 to 24 V DC $\pm 10/15$ % Ripple P-P 10 % or less					
Current consumption		15 mA or less					
Output		NPN open-collector transistor			PNP open-collector transistor		
		<ul style="list-style-type: none"> • Maximum sink current: 100 mA • Applied voltage: 30 V DC or less (between output and 0 V) • Residual voltage: 1 V or less (at 100 mA sink current) 0.4 V or less (at 16 mA sink current) 			<ul style="list-style-type: none"> • Maximum source current: 100 mA • Applied voltage: 30 V DC or less (between output and +V) • Residual voltage: 1 V or less (at 100 mA source current) 0.4 V or less (at 16 mA source current) 		
Utilization category		DC-12 or DC-13					
Output operation		Normally open	Normally closed	Normally open	Normally closed	Normally closed	
Max. response frequency		500 Hz					
Operation indicator		Orange LED (lights up when the output is ON)					
Environmental resistance		Pollution degree					
		3 (Industrial environment)					
		Protection					
		IP68 (IEC), IP68g (JEM) (Refer to p.1010 for details of standards.) (Note 4, 5)					
		Ambient temperature					
		-25 to +70 °C -13 to +158 °F , Storage: -40 to +85 °C -40 to +185 °F					
		Ambient humidity					
		45 to 85 % RH, Storage: 35 to 95 % RH					
Selection Guide		EMC					
		EN 60947-5-2					
		Voltage withstandability					
		1,000 V AC for one min. between all supply terminals connected together and enclosure					
		Insulation resistance					
		50 MΩ, or more, with 500 V DC megger between all supply terminals connected together and enclosure					
		Vibration resistance					
		10 to 500 Hz frequency, 3 mm 0.118 in amplitude in X, Y and Z directions for two hours each					
Amplifier Built-in		Shock resistance					
		10,000 m/s ² acceleration (1,000 G approx.) in X, Y and Z directions for three times each					
GX-F/H		Sensing range variation					
		Temperature characteristics	Over ambient temperature range -25 to +70 °C -13 to +158 °F : Within ±8 % of sensing range at +23 °C +73 °F				
		Voltage characteristics	Within ±2 % for $\pm 10/15$ % fluctuation of the supply voltage				
GXL		Material					
		Enclosure: PBT, Indicator part: Polyester					
GL		Cable					
		0.15 mm ² 3-core oil, heat and cold resistant cabtyre cable, 1 m 3.281 ft long					
GX-U / GX-FU / GX-N		Cable extension					
		Extension up to total 100 m 328.084 ft is possible with 0.3 mm ² , or more, cable.					
GX		Net weight					
		Front sensing type: 20 g approx., Top sensing type: 20 g approx..					

Notes: 1) Where measurement conditions have not been specified precisely, the conditions used were an ambient temperature of +23 °C **+73.4 °F**.

2) "1" in the model No. indicates a different frequency type.

3) The maximum operation distance stands for the maximum distance for which the sensor can detect the standard sensing object.

The stable sensing range stands for the sensing range for which the sensor can stably detect the standard sensing object even if there is an ambient temperature drift and/or supply voltage fluctuation.

4) SUNX's IP68 test method

① Immerse at 0 m below 0 °C **+32 °F** water surface and leave for 30 min. Then, immerse at 0 m below +70 °C **+158 °F** water surface and leave for 30 min.

② Regard the heat shock test in ④ one cycle and perform 20 cycles.

③ Leave in water at a depth of 1 m **3.281 ft** in water for 500 hours.

④ After tests ① to ③ insulation resistance, voltage withstandability, current consumption, and sensing ranges must meet the standard values.

5) If using the sensor in an environment where cutting oil droplets splatter, the sensor may deteriorate due to added substances in the oil.

I/O CIRCUIT DIAGRAMS

GX- \square NPN output type

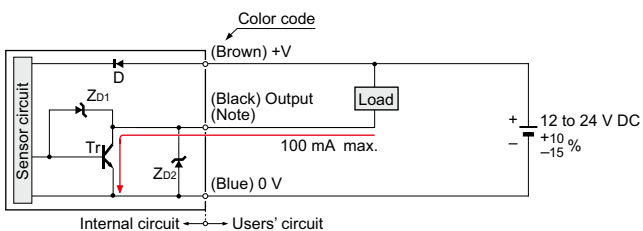

Note: The output does not incorporate a short-circuit protection circuit. Do not connect it directly to a power supply or a capacitive load.

Symbols ... D : Reverse supply polarity protection diode
ZD1, ZD2: Surge absorption zener diode
Tr : NPN output transistor

GX- \square -P PNP output type

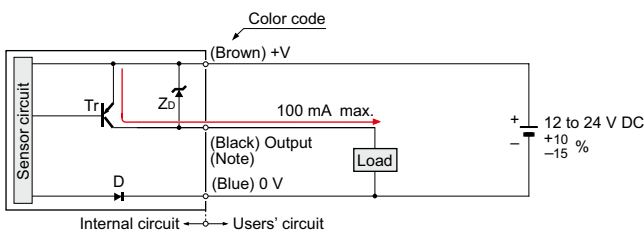

Note: The output does not incorporate a short-circuit protection circuit. Do not connect it directly to a power supply or a capacitive load.

Symbols ... D : Reverse supply polarity protection diode
ZD: Surge absorption zener diode
Tr : PNP output transistor

SENSING CHARACTERISTICS (TYPICAL)

GX-8 type

Sensing field

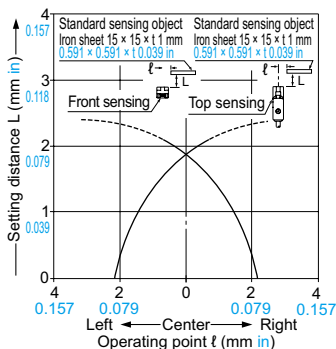

Correlation between sensing object size and sensing range

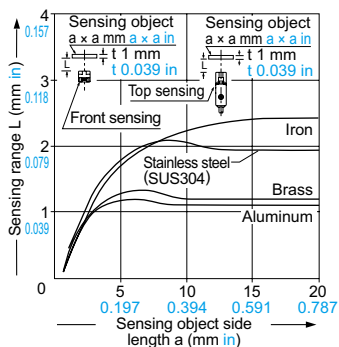

As the sensing object size becomes smaller than the standard size (iron sheet 15 × 15 × t 1 mm 0.591 × 0.591 × t 0.039 in), the sensing range shortens as shown in the left figures.

GX-12 type

Sensing field

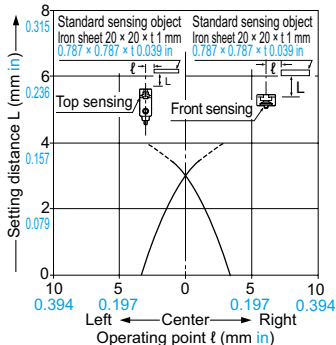

Correlation between sensing object size and sensing range

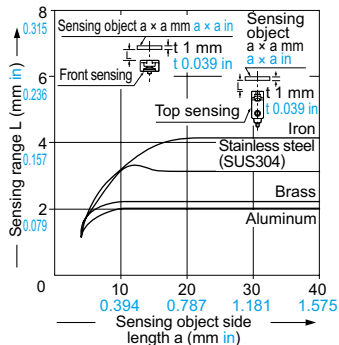

As the sensing object size becomes smaller than the standard size (iron sheet 20 × 20 × t 1 mm 0.787 × 0.787 × t 0.039 in), the sensing range shortens as shown in the left figure.

FIBER SENSORS

LASER SENSORS

PHOTO-ELECTRIC SENSORS

MICRO PHOTO-ELECTRIC SENSORS

AREA SENSORS

SAFETY COMPONENTS

PRESSURE SENSORS

INDUCTIVE PROXIMITY SENSORS

PARTICULAR USE SENSORS

SENSOR OPTIONS

WIRE- SAVING SYSTEMS

MEASURE- MENT SENSORS

STATIC CONTROL DEVICES

LASER MARKERS

Selection Guide

Amplifier Built-in

GX-F/H

GXL

GL

GX-U / GX-FU / GX-N

GX

Amplifier-separated

GA-311 / GH

Other Products

PRECAUTIONS FOR PROPER USE

Refer to p.1012~ for general precautions.



- Never use this product as a sensing device for personnel protection.
- In case of using sensing devices for personnel protection, use products which meet laws and standards, such as OSHA, ANSI or IEC etc., for personnel protection applicable in each region or country.

Mounting

GX-8 type

- Make sure to use a M3 (length: 12 mm 0.472 in or more) truss head screw. The tightening torque should be 0.7 N·m or less. (Do not use a flat head screw or a pan head screw.)

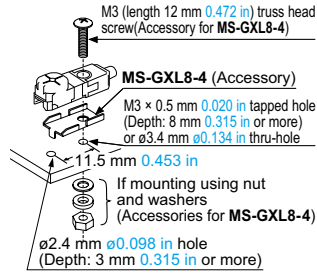

GX-12 type

- The tightening torque should be 0.7 N·m or less.
- To mount the sensor with a nut, the mounting hole diameter should be ø3.4 mm ø0.134 in. Further, the hole in which the boss is inserted should be ø2.5 mm ø0.098 in and 3 mm 0.118 in, or more, deep.

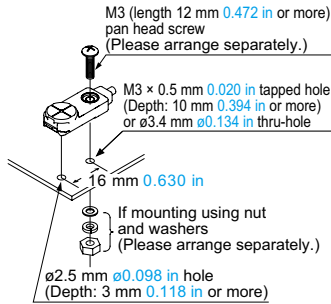

Influence of surrounding metal

- When there is a metal near the sensor, keep the minimum separation distance specified below.

Front sensing type

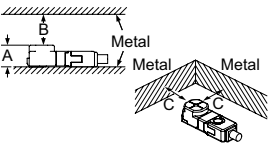

	GX-F8	GX-F12
A	7.4 mm 0.291 in	7.1 mm 0.280 in
B	8 mm 0.315 in	20 mm 0.787 in
C	3 mm 0.118 in	7 mm 0.276 in

Top sensing type

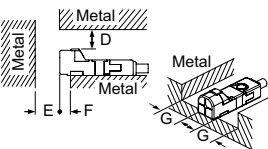

	GX-H8	GX-H12
D	4 mm 0.157 in	7 mm 0.276 in
E	10 mm 0.394 in	20 mm 0.787 in
F	3 mm 0.118 in	3 mm 0.118 in
G	3 mm 0.118 in	3 mm 0.118 in

Mutual interference prevention

- When two or more sensors are installed in parallel or face to face, keep the minimum separation distance specified below to avoid mutual interference.

		H	J
GX-F8	Between "I" type and non "I" type	0 mm (Note 2)	15 mm 0.591 in
	Between two "I" types or two non "I" types	20 mm 0.787 in	35 mm 1.378 in
GX-H8	Between "I" type and non "I" type	0 mm (Note 2)	15 mm 0.591 in
	Between two "I" types or two non "I" types	20 mm 0.787 in	35 mm 1.378 in
GX-F12	Between "I" type and non "I" type	0 mm (Note 2)	25 mm 0.984 in
	Between two "I" types or two non "I" types	25 mm 0.984 in	50 mm 1.969 in

Front sensing

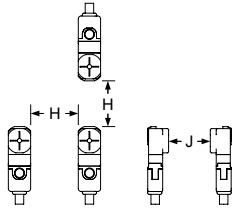

Top sensing

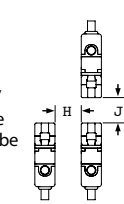

- Notes:
- "I" in the model No. specifies the different frequency type.
 - Close mounting is possible for up to two sensors. When mounting three sensors or more at an equal spacing, align the model with "I" and the model without "I" alternately. The minimum value of dimension "H" should be as given below.
GX-8 type: 6mm 0.236 in
GX-12 type: 6.5mm 0.256 in

Sensing range

- The sensing range is specified for the standard sensing object. With a non-ferrous metal, the sensing range is obtained by multiplying with the correction coefficient specified below. Further, the sensing range also changes if the sensing object is smaller than the standard sensing object or if the sensing object is plated.

Correction coefficient

Model No.	GX-8 type	GX-12 type
Metal		
Iron	1	1
Stainless steel (SUS304)	0.76 approx.	0.79 approx.
Brass	0.50 approx.	0.56 approx.
Aluminum	0.48 approx.	0.53 approx.

Others

- The output does not incorporate a short-circuit protection circuit. Do not connect it directly to a power supply or a capacitive load.
- Do not use during the initial transient time (50 ms) after the power supply is switched on.

DIMENSIONS (Unit: mm in)

The CAD data in the dimensions can be downloaded from the SUNX website: <http://www.sunx.com>

GX-F8

Sensor

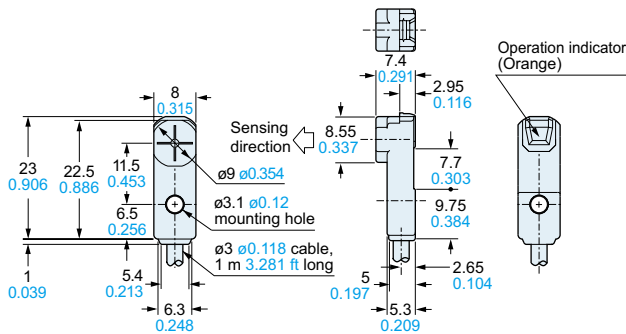

GX-H8

Sensor

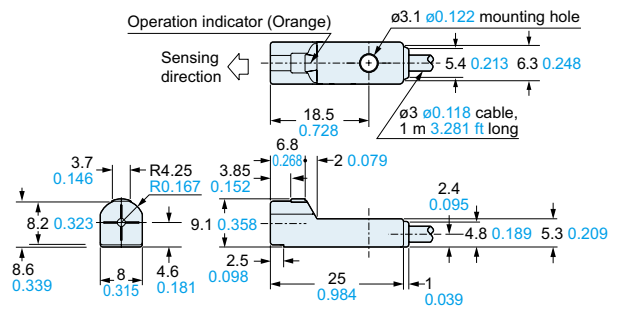

GX-F12

Sensor

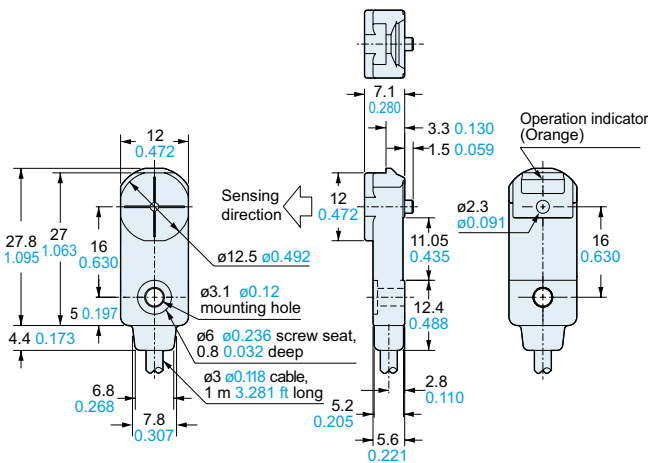

GX-H12

Sensor

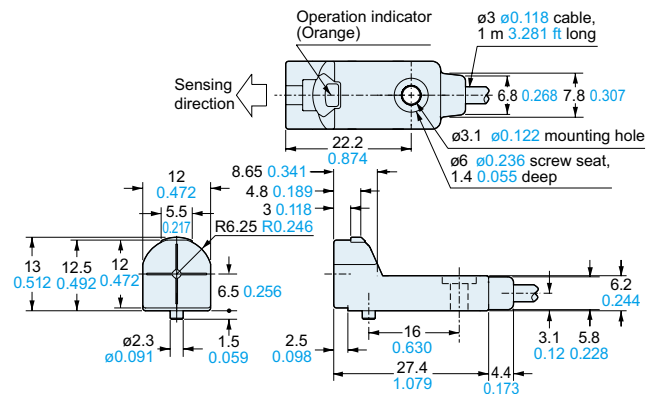

MS-GXL8-4

Sensor mounting bracket for GX-8 type (optional)

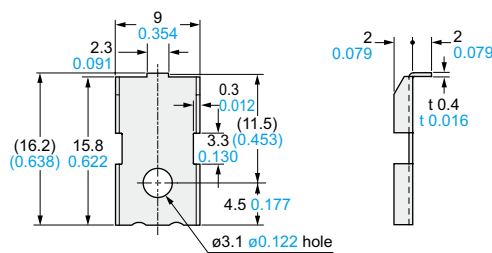

Mounting hole dimensions

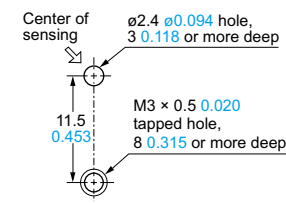

Material: Stainless steel (SUS304)
 1 pc. each of M3 (length 12 mm 0.472 in) truss head screw, nut, spring washer and plain washer are attached.

- FIBER SENSORS
- LASER SENSORS
- PHOTO-ELECTRIC SENSORS
- MICRO PHOTO-ELECTRIC SENSORS
- AREA SENSORS
- SAFETY COMPONENTS
- PRESSURE SENSORS
- INDUCTIVE PROXIMITY SENSORS
- PARTICULAR USE SENSORS
- SENSOR OPTIONS
- WIRE-SAVING SYSTEMS
- MEASUREMENT SENSORS
- STATIC CONTROL DEVICES
- LASER MARKERS
- Selection Guide
- Amplifier Built-in
- GX-F/H
- GXL
- GL
- GX-U / GX-FU / GX-N
- GX
- Amplifier-separated
- GA-311 / GH
- Other Products