

INSTRUCTION MANUAL

Photoelectric Sensor

Amplifier Built-in Type Laser sensor EX-L200 Series

MJE-EXL200 No.0013-43V

Thank you very much for purchasing SUNX products. Please read this Instruction Manual carefully and thoroughly for the correct and optimum use of this product. Kindly keep this manual in a convenient place for quick reference.

⚠ WARNING

- Never use this product as a sensing device for personnel protection.
- In case of using sensing devices for personnel protection, use products which meet laws and standards, such as OSHA, ANSI or IEC etc., for personnel protection applicable in each region or country.
- This product is classified as a "Class 1 laser product" by IEC / JIS standard and FDA.
- Do not look the laser directly. Lasers are potentially hazardous. Furthermore, do not view the laser which is reflected at a specular object.
- Never disassemble, repair or modify the product.
- In case of control or adjustment using procedures other than those specified in this instruction manual, hazardous laser radiation exposure can result.

1 FOR SAFE USE OF A LASER PRODUCT

- About safety standards of laser product, IEC 60825-1 "safety of laser products" has been stipulated by the IEC (International Electrotechnical Commission). In IEC 60825-1, Laser products are divided into classes corresponding to the degree of danger of the laser component, and preventive measures to assure to safety which should be taken with which class are stipulated. This product is classified as "Class 1 laser product" by IEC 60825-1.
- This product complies with 21 CFR 1040.10 and 1040.11 based on Laser Notice No. 50, dated June 24, 2007, issued by CDRH (Center for Devices and Radiological Health) under FDA (Food and Drug Administration). For details, refer to the Laser Notice No. 50.
- **Classification of laser product (IEC 60825-1)**

Classification	Description
Class 1	Safe under reasonably foreseeable conditions.

- **Summary of the safety precautions for laser product users (IEC 60825-1)**

Class	1
Laser safety officer	Not required but recommended for applications that involve direct viewing of the laser beam.
Remote interlock	Not required
Key control	Not required
Beam attenuator protection	Not required
Emission indicator device	Not required
Warning signs	Not required
Beam path	Not required
Specular reflection	No requirements
Eye protection	No requirements
Protective clothing	No requirements
Training	No requirements

Note: This table is intended to provide a convenient summary of precautions. See text of IEC standard for complete precautions.

- **Label**
- Following labels are affixed on this product based on the IEC 60825-1 standard.

<Warning label>

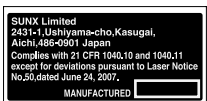

Certification / Identification label



Warning label

<Label position>

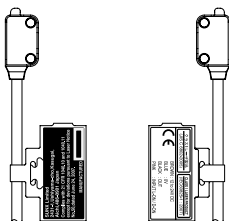

2 PART DESCRIPTION

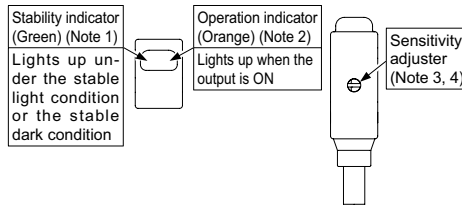

- Notes: 1) Not incorporated on the emitter of thru-beam type.
 2) It is the power indicator (Green: lights up when the power is ON) for the emitter of thru-beam type.
 3) It is not incorporated in emitter of EX-L211□.
 It is not incorporated in EX-L212□.
 4) Be sure that the detection becomes susceptible to vibration, impact and ambient temperature by adjusting the sensitivity adjuster.

3 MOUNTING

- In case mounting this device, use a metal plate **MS-EXL2-2** (Accessory).
- The tightening torque should be 0.5N·m or less with M3 screws.

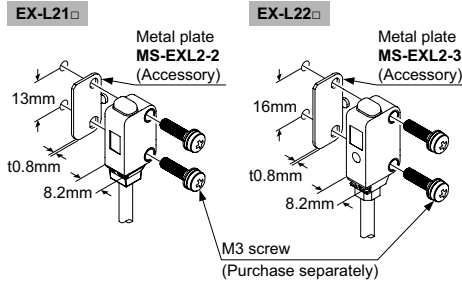

- In case using the dedicated sensor mounting bracket (optional) when mounting this device, the metal plate **MS-EXL2-2** (Accessory) is required depending on the mounting direction. Mount as the diagram below indicates.

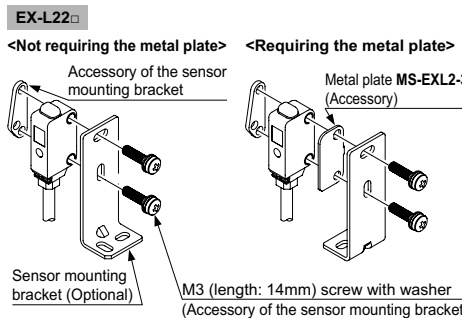
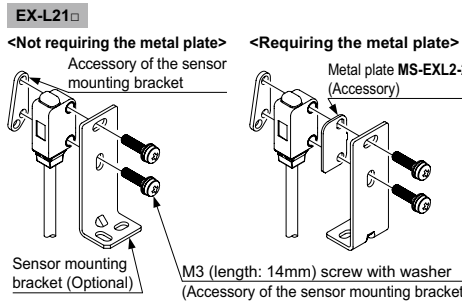

- In case not using the metal plate **MS-EXL2-□** (Accessory) when mounting this product, work on the mounting hole as the diagram below indicates.

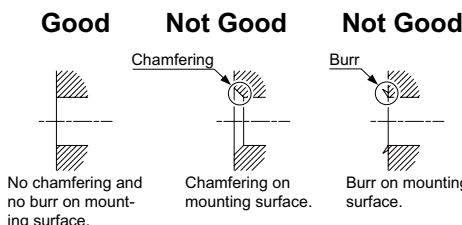
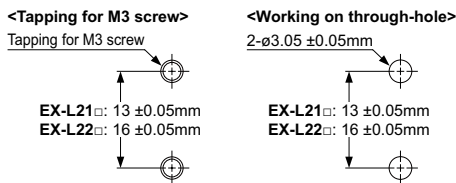

- After mounting the thru-beam type, be sure to adjust light axis of the emission spot to hit the center of the receiver.

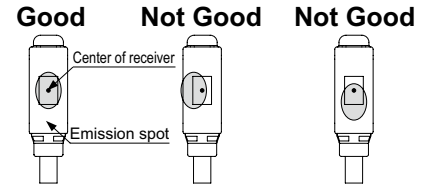

4 WIRING

- Make sure to use the cable with connector, **CN-24A-□-C□** (optional), when connecting to the pigtailed type.
- Tighten the fixing ring of the cable with connector completely by hand when mounting. (The tightening torque: 0.2N·m)
- If the fixing ring is tightened by a tool such as pliers, it may cause connector damage.
- If the tightening is not enough, the fixing ring may loosen due to vibration, etc.

Connecting method

- Insert the cable with connector into a connecting area of this product, and twist the fixing ring of the cable with connector to be fixed.

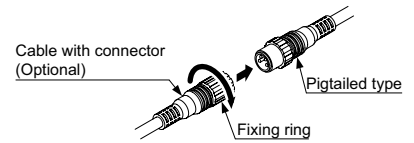

Disconnecting method

- Loosen the fixing ring and pull to separate the connector by holding the fixing ring

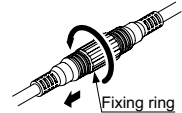

Note: Before disconnecting, be sure that the fixing ring is completely loosened. If the cable is pulled by excessive force (15N or more) when the fixing ring is tightened, the cable may break.

5 I/O CIRCUIT DIAGRAMS

• NPN output type

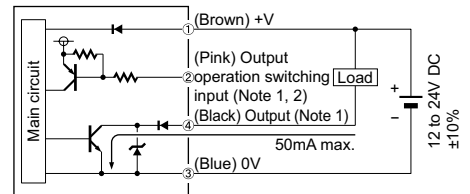

• PNP output type

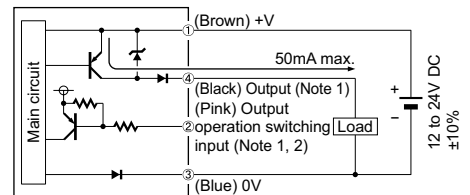

- Notes: 1) The emitter of thru-beam type dose not incorporate output (black) and output operation switching input (pink).
 2) Be able to select either Light-ON or Dark-ON by wiring the output operation switching input (pink) as a following table.

	Light-ON	Dark-ON
Thru-beam type sensor	Wire to 0V	Wire to +V or Open
Spot reflective type	Wire to +V or Open	Wire to 0V

<Terminal arrangement>

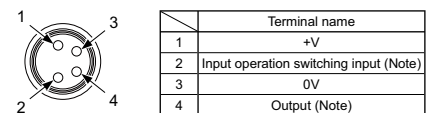

Note: The emitter of thru-beam type dose not incorporate output and output operation switching input.

6 INTENDED PRODUCTS FOR CE MARKING

Step

1. Turn the sensitivity adjuster fully counter-clockwise to the minimum sensitivity position (MIN).



2. In the light received condition, turn sensitivity adjuster slowly clockwise and confirm the point A where the sensor enters the "Light" state operation.



3. In the dark condition, turn sensitivity adjuster further clockwise until the sensor enters the "Light" state operation and then bring it back to confirm point B where the sensor just returns to the "Dark" state operation.

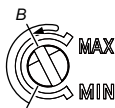

(If the sensor does not enter the "Light" state operation even when the sensitivity adjuster is turned fully clockwise, this extreme position is point B.

4. The position at the middle of point A and B is the optimum sensing position.

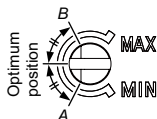

Note: Use the flathead screwdriver (please arrange separately) to turn the adjuster slowly. Turning with excessive strength will cause damage to adjuster.

7 AUTOMATIC INTERFERENCE PREVENTION FUNCTION

- Spot reflective type sensor incorporate this function. Up to two sets of sensor can be mounted closely. (Thru-beam type sensor does not have this function.)

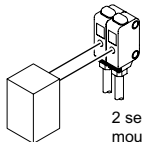

2 sensor heads can be mounted adjacently

Note: If two spot reflective type sensor are mounted facing each other, they should be angled so as not to receive the beam from the opposing sensor or to detect its front face.

Not Good

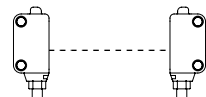

Good

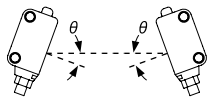

8 INTENDED PRODUCTS FOR CE MARKING

- The model listed under "9 SPECIFICATIONS" comes with CE Marking. As for all other models, please contact our sales office.



9 SPECIFICATIONS

Type	Thru-beam type		Spot reflective type
	Long distance	Long distance	
Model No. (Note 1, 2)	2m cable type Pigtalled type	EX-L211(-P) EX-L211(-P)-J	EX-L212(-P) EX-L212(-P)-J
Sensing range	1m	3m	45 to 300 mm (Note3)
Emission spot size (typical)	6 × 4mm (vertical × horizontal) (at 1m sensing range) (Note 4)	8 × 5.5mm (vertical × horizontal) (at 1m sensing range) (Note 4, 5)	Less than ø1mm (at 300mm sensing range) (Note 6)
Sensing object	ø2mm or more of opaque object	ø3mm or more of opaque object	Opaque, translucent or transparent object
Minimum sensing object (typical) (Note 7)	ø0.3mm of opaque object (at 1m sensing range)	-	ø0.01mm of gold wire
Supply voltage	12 to 24V DC ±10% Ripple P-P 10% or less		
Current consumption	Emitter: 10mA or less, Receiver: 10mA or less		15mA or less
Hysteresis (typical)	-		20% of operation distance (Note 3)
Output	<NPN output type> NPN open-collector transistor • Maximum sink current: 50mA • Applied voltage: 26.4V DC or less (between output and 0V) • Residual voltage: 2V or less (at 50mA sink current) 1V or less (at 16mA sink current)		<PNP output type> PNP open-collector transistor • Maximum source current: 50mA • Applied voltage: 26.4V DC or less (between output and +V) • Residual voltage: 2V or less (at 50mA source current) 1V or less (at 16mA source current)
	Output operation	Light-ON (wiring to 0V) / Dark-ON (wiring to +V, or Open) Select by the output operation switching input	
Short-circuit protection	Incorporated		
Response time	0.5ms or less		
Interference prevention function	-		Incorporated (2 heads are possible to mount adjacently)
Protection	IP67 (IEC)		
Ambient temperature	-10 to +55°C (No dew condensation or no icing condition), Storage: -30 to +70°C		
Ambient humidity	35 to 85% RH, Storage: 35 to 85% RH		
Emitting element	Red semiconductor laser class 1 (IEC / JIS), Class 1 (FDA) [Peak emission wavelength: 655nm, Maximum output: 0.39mW (2mW for EX-L221□)]		
Material	Enclosure : Polybutylene terephthalate, Front cover : PMMA		
Cable	2m cable type	0.15mm ² 4-core (emitter: 2-core) cabtyre cable, 2m long	
	Pigtalled type	0.15mm ² 4-core (emitter: 2-core) cabtyre cable with connector, 0.2m long	
Weight	2m cable type	Emitter: Approx. 40g, Receiver: Approx. 40g	Approx. 45g
	Pigtalled type	Emitter: Approx. 10g, Receiver: Approx. 10g	Approx. 10g
Accessory	MS-EXL2-2 (Metal plate): 2 pcs.		MS-EXL2-3 (Metal plate): 1 pc.

Notes: 1) The model No. with suffix "E" shown on the label affixed is the emitter, "D" shown on the label is the receiver.

Emitter: EX-L211E, Receiver: EX-L211D

2) The model No. with suffix "-P" is PNP output model.

<Example> PNP output model of EX-L211 is "EX-L211-P."

The model No. with suffix "-C5" is 5m cable model.

<Example> 5m cable model of EX-L211F-P is "EX-L211F-P-C5."

3) The sensing distance and the hysteresis of spot reflective type is value for non-gloss white paper (100 × 100mm).

4) The beam of emitter may enter receiver even if it is out of the range of the emission spot. In case using this devices as cascaded, we recommend to mount emitters and receivers alternately. In case mounting this devices in another method, be sure to check the operation with this device.

5) In case the sensing distance is 3m, the emission spot size is 17 × 11mm (vertical × horizontal) (visual reference value.)

6) In case high reflective object is existing between this product and the sensing object, this product may detect it.

7) make sure to confirm detection with an actual sensor before uses.

8) Make sure to use the flowing cables when connecting the pigtailed type.

<Straight Cable>

CN-24A-C2 (Cable length : 2m), CN-24A-C5 (Cable length : 5m)

<Elbow cable>

CN-24AL-C2 (Cable length : 2m), CN-24AL-C5 (Cable length : 5m)

10 CAUTIONS

- This product has been developed / produced for industrial use only.
- Make sure to carry out wiring in the power supply OFF condition.
- Take care that if a voltage exceeding the rated range is applied, or if an AC power supply is directly connected, the product may get burnt or damaged.
- Take care that short circuit of the load or wrong wiring may burn or damage the product.
- Do not run the wires together with high-voltage lines or power lines, or put them in the same raceway. This can cause malfunction due to induction.
- Verify that the supply voltage variation is within the rating.
- If power is supplied from a commercial switching regulator, ensure that the frame ground (F.G.) terminal of the power supply is connected to an actual ground.
- In case equipment generating noise (switching regulator, inverter motor, etc.) is used in the vicinity of this product, connect the frame ground (F.G.) terminal of the equipment to an actual ground.
- Do not use during the initial transient time (approx. 50ms) after the power supply is switched ON.
- In case the load and this sensor are connected to different power supplies, be sure to turn ON the power from the sensor.
- Extension up to total 100m or less, is possible with more than 0.3mm² of electric conductor cross-sectional area cable. However, in order to reduce noise, make the wiring as short as possible.
- Make sure that stress by forcible bend or pulling is not applied to the sensor cable joint.
- The cable may break by applying excess stress in low temperature.
- Take care that the sensor is not directly exposed to fluorescent lamp from a rapid-starter lamp, a high frequency lighting device or sunlight etc., as it may affect the sensing performance.
- This product is suitable for indoor use only.
- Do not allow any water, oil fingerprints, etc., which may refract light, or dust, dirt, etc., which may block light, to stick to the emitting / receiving surfaces of the sensor head. In case they are present, wipe them with a clean, soft cloth or lens paper.
- Do not use this sensor in places having excessive vapor, dust, etc., or where it may come in contact with corrosive gas, etc.

- Take care that the sensor does not come in contact with oil, grease, organic solvents such as thinner, etc., strong acid, or alkaline.
- Make sure that the power is OFF while cleaning the emitting / receiving windows of the sensor head.
- This device is using a laser which has high directional quality. Therefore the beam possibly be out of alignment by the mounting condition of this device or distortion of housing etc. Make sure to adjust the beam axe alignment before use.

SUNX Limited

URL : sunx.com

Overseas Sales Division (Head Office)
2431-1 Ushiyama-cho, Kasugai-shi, Aichi, 486-0901, Japan
Phone: +81-568-33-7861 FAX: +81-568-33-8591

Europe Headquarter: Panasonic Electric Works Europe AG
Rudolf-Diesel-Ring 2, D-83607 Holzkirchen, Germany
Phone: +49-8024-648-0

US Headquarter:
Panasonic Electric Works Corporation of America
629 Central Avenue New Providence, New Jersey 07974 USA
Phone: +1-908-464-3550

PRINTED IN JAPAN

March, 2010