

# EQ-30 SERIES

Related Information

General terms and conditions .....P.1  
Glossary of terms.....P.983~

Sensor selection guide .....P.11~ / P.229~  
General precautions.....P.986~



SUNX website <http://www.sunx.com>



## Unaffected by color or material, 2 m (6.562 ft) distance adjustable range reflective sensing

### Hardly affected by object color or background

As the EQ-30 series is incorporated with a 2-segment photodiode as the receiving element with a unique circuitry, it detects an object at the same distance regardless of its color or the background beyond the adjusted sensing range.

(However, when the background is specular, it may be necessary to change the angle of the sensor.)

### Long sensing range 2 m 6.562 ft

The EQ-30 series can detect an object 2 m 6.562 ft away. It is suitable for various applications, such as, sensing objects or positioning objects traveling on a wide assembly line, etc.

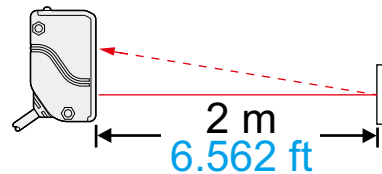

[ EQ-34: Correlation between material (200 x 200 mm 7.874 x 7.874 in) and sensing range (typical) ]

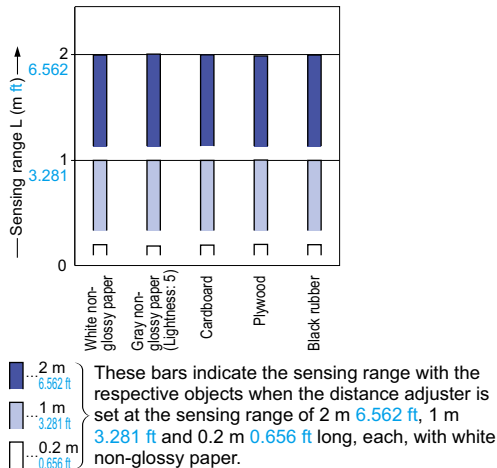

### Two distances (far and near) can be set

EQ-34W

With EQ-34W, two sensing distances, Far (Main) and Near (Sub), can be set. Hence, one sensor can suffice where, earlier, two were required.

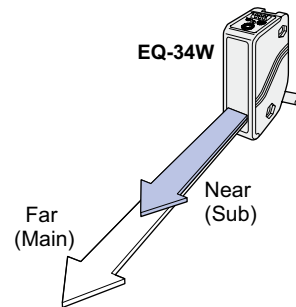

- Selection Guide
- Amplifier Built-in
- CX-400**
- EX-10
- EX-20
- EX-30
- EX-40
- EQ-30**
- EQ-500
- MQ-W
- RX-LS200
- RX
- CY
- PX-2
- RT-610
- Power Supply Built-in
- NX5
- VF
- Amplifier-separated
- SU-7 / SH
- SS-A5 / SH
- Other Products

ORDER GUIDE  
P.299SPECIFICATIONS  
P.300I/O CIRCUIT DIAGRAMS  
P.301SENSING CHARACTERISTICS  
P.302~PRECAUTIONS FOR PROPER USE  
P.303~DIMENSIONS  
P.305~

## APPLICATIONS

## Detecting traveling cardboard boxes

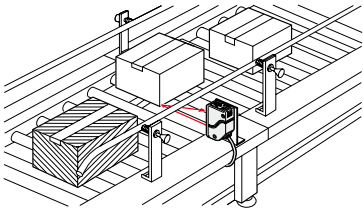

## Detecting level in hopper

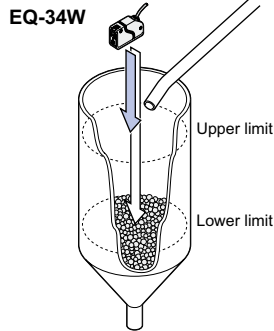

## ENVIRONMENTAL RESISTANCE

## Insusceptible to contamination on lens

The fixed-focus sensing keeps the detectability better than diffuse reflective type sensors even if the lens is contaminated by dirt, dust, mist, or smoke under an unclean environment.

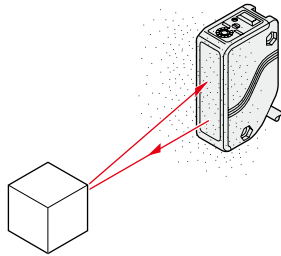

## Waterproof

It has IP67 protection. It can be used in places splashed with water.

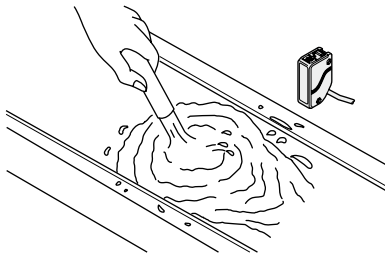

Note: However, take care that if it is exposed to water splashes during operation, it may detect a water drop itself.

## Principle of adjustable range reflective sensing with 2-segment photodiode

Normal reflective type sensors operate by sensing the variation in the amount of incident beam. However, the adjustable range reflective sensing type sensor incorporating the 2-segment photodiode operates by sensing the variation in the incident beam angle. Thus, the output is activated according to the distance of the object from the sensor. This system helps the EQ-30 series in being unaffected by object color or a background, enabling stable sensing.

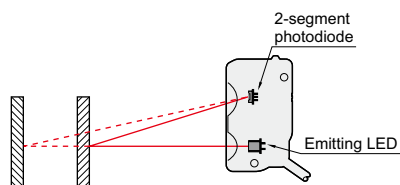

Sensing is based on the difference in the incident beam angle of the dotted line and the solid line in the above figure.

## OPERABILITY

## Mechanical 2-turn adjuster with indicator

It features a mechanical 2-turn distance adjuster with an indicator that shows the set distance at a glance.

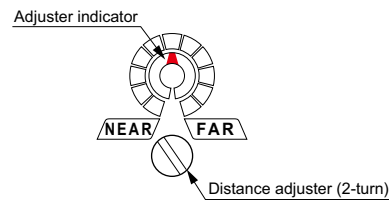

## MOUNTING / SIZE

## Compact

It saves space, since a miniaturized housing of W20 × H68 × D40 mm **W0.787 × H2.677 × D1.575 in** has been designed for the adjustable range reflective sensing sensor even though the adjustable sensing range is 2 m **6.562 ft** long.

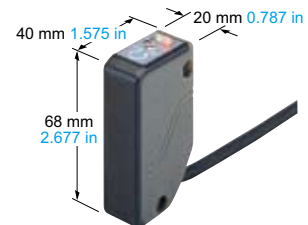

## VARIETIES

## Plug-in connector type is available

Plug-in connector type, which can be easily disconnected for replacement is available. In case a problem occurs, anyone can replace the sensor in a minute. (Excluding EQ-34W)

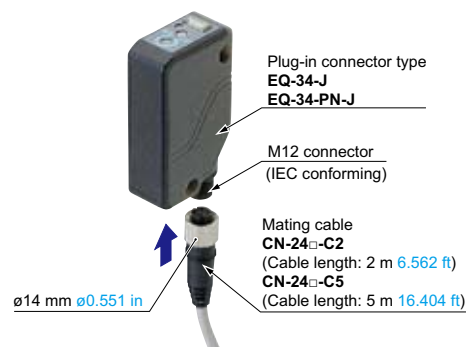

FIBER SENSORS

LASER SENSORS

PHOTOELECTRIC SENSORS

MICRO PHOTOELECTRIC SENSORS

AREA SENSORS

SAFETY COMPONENTS

PRESSURE SENSORS

INDUCTIVE PROXIMITY SENSORS

PARTICULAR USE SENSORS

SENSOR OPTIONS

WIRE-SAVING SYSTEMS

MEASUREMENT SENSORS

STATIC CONTROL DEVICES

LASER MARKERS

Selection Guide

Amplifier Built-in

CX-400

EX-10

EX-20

EX-30

EX-40

EQ-30

EQ-500

MQ-W

RX-LS200

RX

CY

PX-2

RT-610

Power Supply Built-in

NX5

VF

Amplifier-separated

SU-7 / SH

SS-A5 / SH

Other Products

**ORDER GUIDE**

Type	Appearance	Adjustable range (Note)	Model No.	Output
NPN output		0.2 to 2 m 0.656 to 6.562 ft	EQ-34	NPN open-collector transistor
PNP output			EQ-34-PN	PNP open-collector transistor
Two outputs			EQ-34W	Two NPN open-collector transistor outputs

**NOTE:** Mounting bracket is not supplied with the sensor. Please select from the range of optional sensor mounting brackets (two types).

Note: The adjustable range stands for the maximum sensing range which can be set with the adjuster.  
 The sensor can detect an object 0.1 m 0.328 ft, or more, away.  
 However, the detectable range of Near (Sub) type of EQ-34W begins at 0.2 m 0.656 ft.

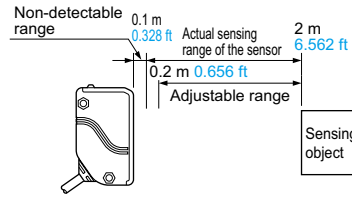

**Plug-in connector type (Not available for EQ-34W)**

Plug-in connector type (standard: cable type) is also available. (excluding EQ-34W)  
 When ordering this type, suffix "-J" to the model No.  
 Please order the suitable mating cable separately.  
 Model No.: EQ-34-J, EQ-34-PN-J

**Mating cable**

Type	Model No.	Description
Straight	CN-24-C2	Length: 2 m 6.562 ft
	CN-24-C5	Length: 5 m 16.404 ft
Elbow	CN-24L-C2	Length: 2 m 6.562 ft
	CN-24L-C5	Length: 5 m 16.404 ft

0.34 mm<sup>2</sup> 4-core cabtyre cable with connector on one end  
 Cable outer diameter: ø5 mm ø0.197 in

**CN-24-C**

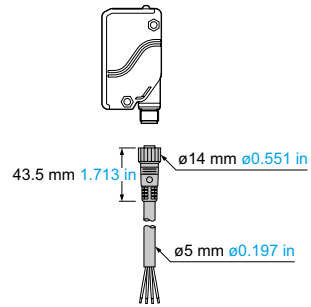

**CN-24L-C**

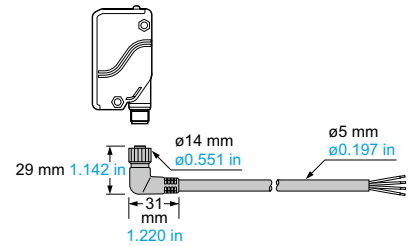

**5 m 16.404 ft cable length type**

5 m 16.404 ft cable length type (standard : 2 m 6.562 ft) is also available for NPN output type and two outputs type.  
 When ordering this type, suffix "-C5" to the model No.  
 Model No.: EQ-34-C5, EQ-34W-C5

**OPTIONS**

Designation	Model No.	Description
Sensor mounting bracket	MS-EQ3-1	Back angled mounting bracket
	MS-EQ3-2	Foot angled mounting bracket

Note: The plug-in connector type does not allow use of some sensor mounting brackets because of the protrusion of the connector.

**Sensor mounting bracket**

**MS-EQ3-1**

Two M4 (length 25 mm 0.984 in) screws with washers and two M4 nuts are attached.

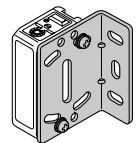

**MS-EQ3-2**

Two M4 (length 25 mm 0.984 in) screws with washers and two M4 nuts are attached.

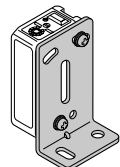

## SPECIFICATIONS

Item	Type	NPN output	PNP output	Two outputs
	Model No.	EQ-34	EQ-34-PN	EQ-34W
Adjustable range (Note 2)		0.2 to 2 m <b>0.656 to 6.562 ft</b>		Far (Main): 0.2 to 2 m <b>0.656 to 6.562 ft</b> Near (Sub): Refer to diagram in (Note 3)
Sensing range (with white non-glossy paper at setting distance 2 m <b>6.562 ft</b> )		0.1 to 2 m <b>0.328 to 6.562 ft</b>		Far (Main): 0.1 to 2 m <b>0.328 to 6.562 ft</b> Near (Sub): 0.2 to 2 m <b>0.656 to 6.562 ft</b> [with Near (Sub) distance for adjuster at max.]
Hysteresis		10 % or less of operation distance (With white non-glossy paper)		
Repeatability		Along sensing axis: 10 mm <b>0.394 in</b> or less, Perpendicular to sensing axis: 1 mm <b>0.039 in</b> or less (with white non-glossy paper)		
Supply voltage		10 to 30 V DC Ripple P-P 10 % or less		
Current consumption		50 mA or less	55 mA or less	90 mA or less
Output		NPN open-collector transistor • Maximum sink current: 100 mA • Applied voltage: 30 V DC or less (between output and 0 V) • Residual voltage: 1 V or less (at 100 mA sink current) 0.4 V or less (at 16 mA sink current)	PNP open-collector transistor • Maximum source current: 100 mA • Applied voltage: 30 V DC or less (between output and +V) • Residual voltage: 1 V or less (at 100 mA source current) 0.4 V or less (at 16 mA source current)	<Far (Main) output, Near (Sub) output> NPN open-collector transistor • Maximum sink current: 100 mA • Applied voltage: 30 V DC or less (between output and 0 V) • Residual voltage: 1 V or less (at 100 mA sink current) 0.4 V or less (at 16 mA sink current)
Utilization category		DC-12 or DC-13		
Output operation		Switchable either Detection-ON or Detection-OFF		
Short-circuit protection		Incorporated		
Response time		2 ms or less		
Operation indicator		Red LED (lights up when the output is ON)		Far (Main) output: Red LED [ lights up when the Far (Main) output is ON ] Near (Sub) output: Red LED [ lights up when the Near (Sub) output is ON ]
Stability indicator		Green LED (lights up under stable light received condition or stable dark condition) (Note 4)		
Distance adjuster		2-turn mechanical adjuster with pointer		Far (Main): 2-turn mechanical adjuster with pointer Near (Sub): Variable adjuster
Automatic interference prevention function		Incorporated (Note 5)		
Environmental resistance	Pollution degree	3 (Industrial environment)		
	Protection	IP67 (IEC) (Refer to p.984 for details of standards.)		
	Ambient temperature	-20 to +55 °C <b>-4 to +131 °F</b> (No dew condensation or icing allowed), Storage: -25 to +70 °C <b>-13 to +158 °F</b>		
	Ambient humidity	35 to 85 % RH, Storage: 35 to 85 % RH		
	Ambient illuminance	Incandescent light: 3,000 lx at the light-receiving face		
	EMC	EN 60947-5-2		
	Voltage withstandability	1,000 V AC for one min. between all supply terminals connected together and enclosure		
	Insulation resistance	20 MΩ, or more, with 250 V megger between all supply terminals connected together and enclosure		
Vibration resistance	10 to 55 Hz frequency, 1.5 mm <b>0.059 in</b> amplitude (10 G max.) in X, Y and Z directions for two hours each			
Shock resistance	500 m/s <sup>2</sup> acceleration (50 G approx.) in X, Y and Z directions for three times each			
Emitting element		Infrared LED (Peak emission wavelength: 880 nm <b>0.035 mil</b> , modulated)		
Material		Enclosure: Polyallylate and Polyethylene terephthalate, Lens: Polyallylate		
Cable		0.3 mm <sup>2</sup> 3-core (EQ-34W: 4-core) cabtyre cable, 2 m <b>6.562 ft</b> long		
Cable extension		Extension up to total 100 m <b>328.084 ft</b> is possible with 0.3 mm <sup>2</sup> , or more, cable.		
Weight		Net weight: 150 g approx., Gross weight: 200 g approx.		
Accessory		Adjusting screwdriver: 1 pc.		

Notes: 1) Where measurement conditions have not been specified precisely, the conditions used were an ambient temperature of +23 °C **+73.4 °F**.

- 2) The adjustable range stands for the maximum sensing range which can be set with the adjuster. The sensor can detect an object 0.1 m **0.328 ft**, or more, away. However, the detectable area of the Near (Sub) type of the EQ-34W begins at 0.2 m **0.656 ft**.

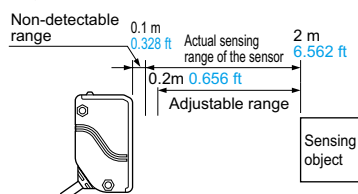

- 4) Refer to "PRECAUTIONS FOR PROPER USE" (p.303) for details of the stability indicator.

- 3) The Near (Sub) distance adjustable range, L<sub>2</sub>, changes with the setting of the Far (Main) distance, L<sub>1</sub>, as shown in the table below.

EQ-34W Near (Sub) distance adjustable range

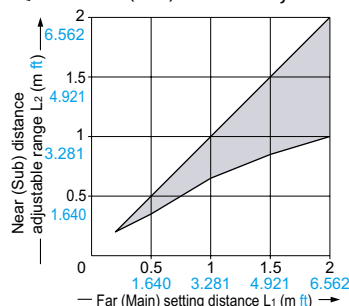

EQ-34W	
Far (Main) setting distance L <sub>1</sub>	Near (Sub) distance adjustable range L <sub>2</sub>
2 m <b>6.562 ft</b>	1 to 2 m <b>3.281 to 6.562 ft</b>
1.5 m <b>4.921 ft</b>	0.85 to 1.5 m <b>2.789 to 4.921 ft</b>
1 m <b>3.281 ft</b>	0.65 to 1 m <b>2.133 to 3.281 ft</b>
0.5 m <b>1.640 ft</b>	0.35 to 0.5 m <b>1.148 to 1.640 ft</b>
0.2 m <b>0.656 ft</b>	0.2 m <b>0.656 ft</b>

- 5) Detection may become unstable depending on the setting conditions or the sensing objects. After setting up this product, make sure to check operations using actual sensing objects.

FIBER SENSORS

LASER SENSORS

PHOTO-ELECTRIC SENSORS

MICRO PHOTO-ELECTRIC SENSORS

AREA SENSORS

SAFETY COMPONENTS

PRESSURE SENSORS

INDUCTIVE PROXIMITY SENSORS

PARTICULAR USE SENSORS

SENSOR OPTIONS

WIRE- SAVING SYSTEMS

MEASURE- MENT SENSORS

STATIC CONTROL DEVICES

LASER MARKERS

Selection Guide

Amplifier Built-in

CX-400

EX-10

EX-20

EX-30

EX-40

EQ-30

EQ-500

MQ-W

RX-LS200

RX

CY

PX-2

RT-610

Power Supply Built-in

NX5

VF

Amplifier-separated

SU-7 / SH

SS-A5 / SH

Other Products

I/O CIRCUIT AND WIRING DIAGRAMS

- FIBER SENSORS
- LASER SENSORS
- PHOTO-ELECTRIC SENSORS
- MICRO PHOTO-ELECTRIC SENSORS
- AREA SENSORS
- SAFETY COMPONENTS
- PRESSURE SENSORS
- INDUCTIVE PROXIMITY SENSORS
- PARTICULAR USE SENSORS
- SENSOR OPTIONS
- WIRE-SAVING SYSTEMS
- MEASUREMENT SENSORS
- STATIC CONTROL DEVICES
- LASER MARKERS
- Selection Guide
- Amplifier Built-in
- CX-400**
- EX-10**
- EX-20**
- EX-30**
- EX-40**
- EQ-30**
- EQ-500**
- MQ-W**
- RX-LS200**
- RX**
- CY**
- PX-2**
- RT-610**
- Power Supply Built-in
- NX5**
- VF**
- Amplifier-separated
- SU-7 / SH**
- SS-A5 / SH**
- Other Products

EQ-34

NPN output type

I/O circuit diagram

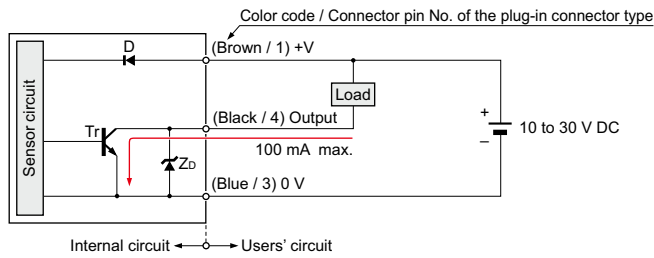

Wiring diagram

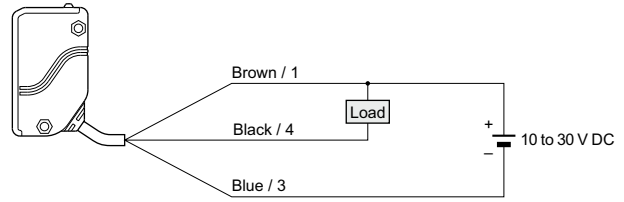

Connector pin position (Plug-in connector type)

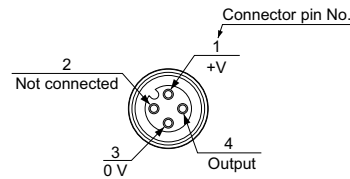

Symbols ... D : Reverse supply polarity protection diode  
 ZD: Surge absorption zener diode  
 Tr : NPN output transistor

EQ-34-PN

PNP output type

I/O circuit diagram

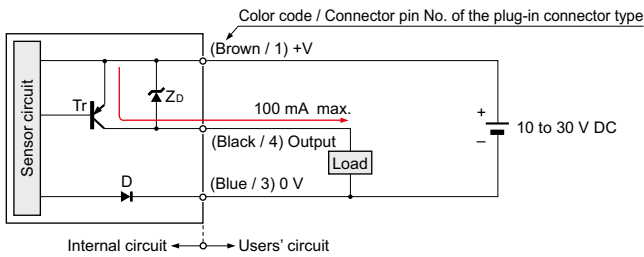

Wiring diagram

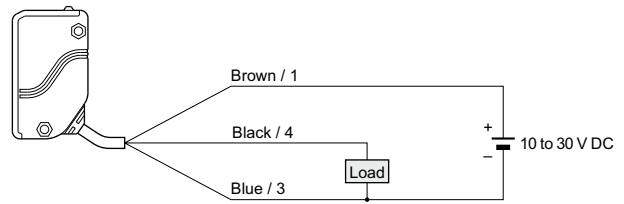

Connector pin position (Plug-in connector type)

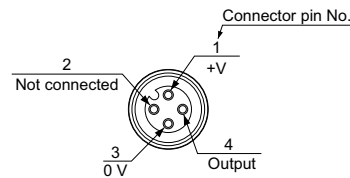

Symbols ... D : Reverse supply polarity protection diode  
 ZD: Surge absorption zener diode  
 Tr : PNP output transistor

EQ-34W

Two outputs type

I/O circuit diagram

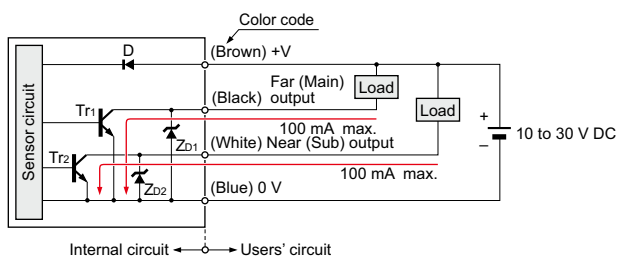

Wiring diagram

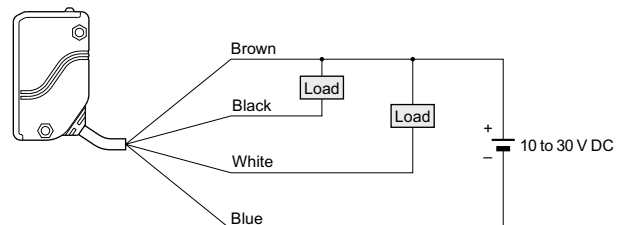

Symbols ... D: Reverse supply polarity protection diode  
 ZD1, ZD2: Surge absorption zener diode  
 Tr1, Tr2 : NPN output transistor

**SENSING CHARACTERISTICS (TYPICAL)**

**EQ-34 EQ-34-PN**

**Sensing fields**

Setting distance: 1 m 3.281 ft

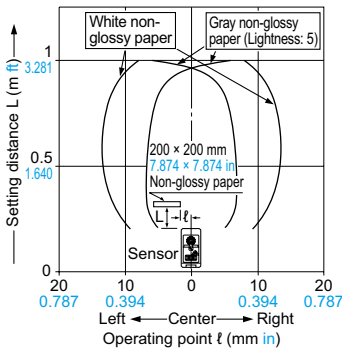

Setting distance: 1.5 m 4.921 ft

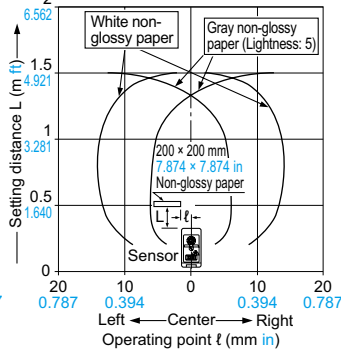

Setting distance: 2 m 6.562 ft

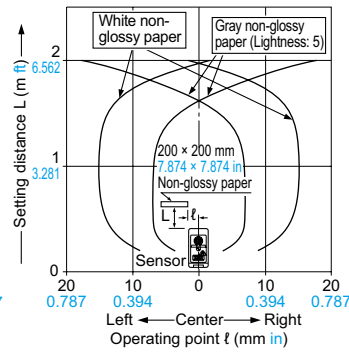

**Emitted beam**

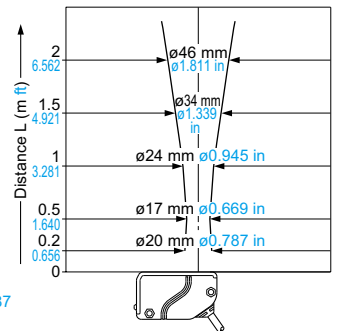

Correlation between color (200 x 200 mm 7.874 x 7.874 in non-glossy paper) and sensing range

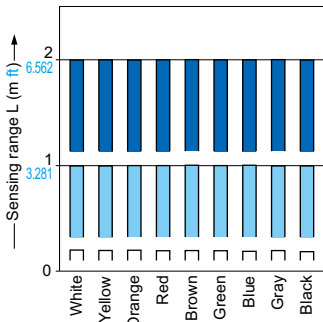

These bars indicate the sensing range with the respective colors when the distance adjuster is set at the sensing range of 2 m 6.562 ft, 1 m 3.281 ft and 0.2 m 0.656 ft long, each, with white color. The sensing distance varies depending also on material.

Correlation between material (200 x 200 mm 7.874 x 7.874 in) and sensing range

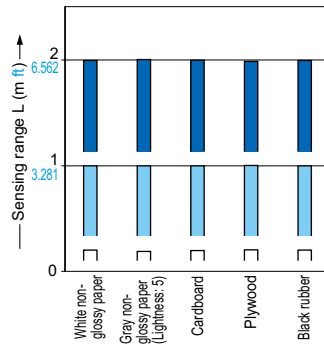

These bars indicate the sensing range with respective objects when the distance adjuster is set at the sensing range of 2 m 6.562 ft, 1 m 3.281 ft and 0.2 m 0.656 ft long, each, with white non-glossy paper.

**EQ-34W**

**Sensing fields**

Far (Main) [Far (Main) setting distance: 1 m 3.281 ft]

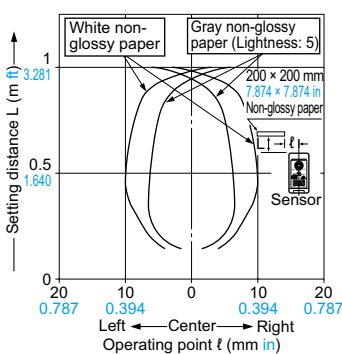

Far (Main) [Far (Main) setting distance: 1.5 m 4.921 ft]

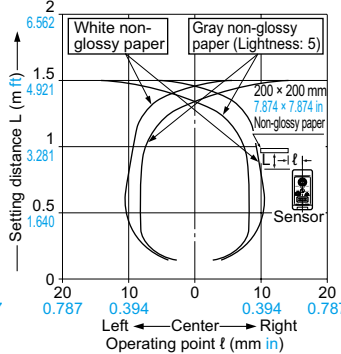

Far (Main) [Far (Main) setting distance: 2 m 6.562 ft]

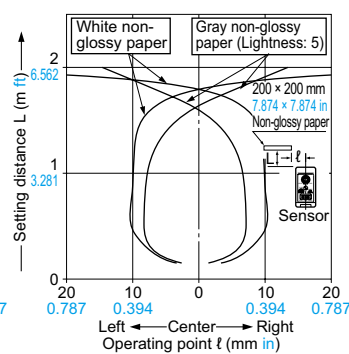

Near (Sub) [Far (Main) setting distance: 1 m 3.281 ft]

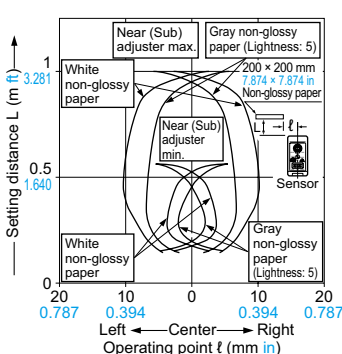

Near (Sub) [Far (Main) setting distance: 1.5 m 4.921 ft]

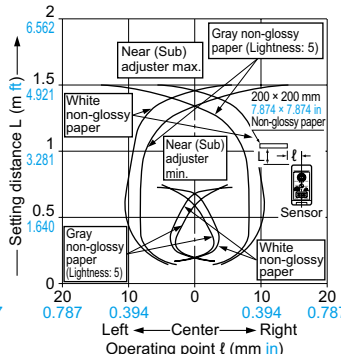

Near (Sub) [Far (Main) setting distance: 2 m 6.562 ft]

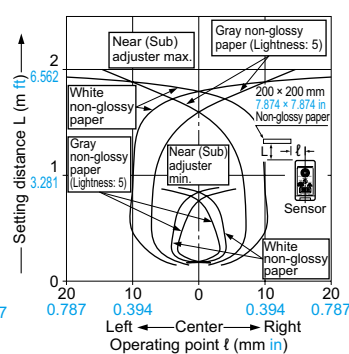

**Emitted beam**

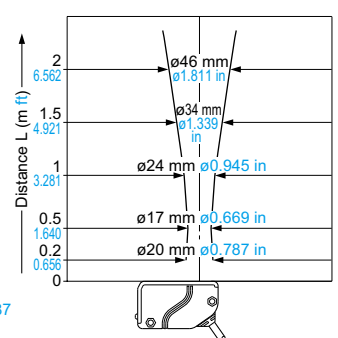

FIBER SENSORS

LASER SENSORS

PHOTO-ELECTRIC SENSORS

MICRO PHOTO-ELECTRIC SENSORS

AREA SENSORS

SAFETY COMPONENTS

PRESSURE SENSORS

INDUCTIVE PROXIMITY SENSORS

PARTICULAR USE SENSORS

SENSOR OPTIONS

WIRE- SAVING SYSTEMS

MEASURE- MENT SENSORS

STATIC CONTROL DEVICES

LASER MARKERS

Selection Guide

Amplifier Built-in

**CX-400**

**EX-10**

**EX-20**

**EX-30**

**EX-40**

**EQ-30**

**EQ-500**

**MQ-W**

**RX-LS200**

**RX**

**CY**

**PX-2**

**RT-610**

Power Supply Built-in

**NX5**

**VF**

Amplifier-separated

**SU-7 / SH**

**SS-A5 / SH**

Other Products

**SENSING CHARACTERISTICS (TYPICAL)**

**EQ-34W**

Correlation between color (200 x 200 mm 7.874 x 7.874 in non-glossy paper) and sensing range

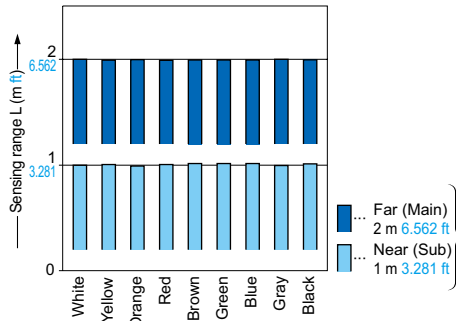

These bars indicate the sensing range with respective colors when the distance adjuster is set at the sensing range of Far (Main) 2 m 6.562 ft and Near (Sub) 1 m 3.281 ft long, each, with white color. The sensing distance varies depending also on material.

Correlation between material (200 x 200 mm 7.874 x 7.874 in) and sensing range

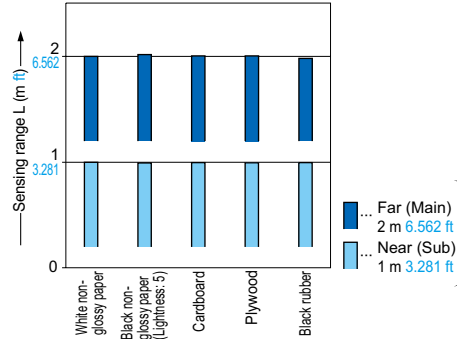

These bars indicate the sensing range with respective objects when the distance adjuster is set at the sensing range of Far (Main) 2 m 6.562 ft and Near (Sub) 1 m 3.281 ft long, each, with white non-glossy paper.

**PRECAUTIONS FOR PROPER USE**

Refer to p.986~ for general precautions.



- Never use this product as a sensing device for personnel protection.
- In case of using sensing devices for personnel protection, use products which meet laws and standards, such as OSHA, ANSI or IEC etc., for personnel protection applicable in each region or country.

**Mounting**

- The tightening torque should be 0.8 N·m or less.

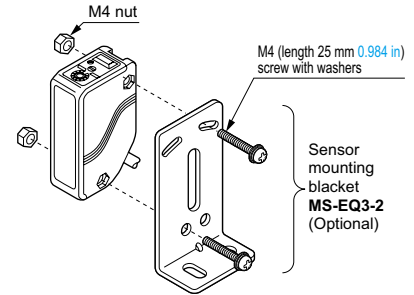

**Stability indicator**

- Since the EQ-30 series uses a 2-segment photodiode as its receiving element, and sensing is done based on the difference in the incident beam angle of the reflected beam from the sensing object, the output and the operation indicator operate according to the object distance. Further, the stability indicator shows the margin of the incident light intensity and not that of the object distance. Hence, the distance at which it lights up/off depends on the object reflectivity and is not at all related to the output operation. Do not use the sensor when the stability indicator is off (unstable light received condition), since the sensing will be unstable.

- Care must be taken regarding the sensor mounting direction with respect to the object's direction of movement.

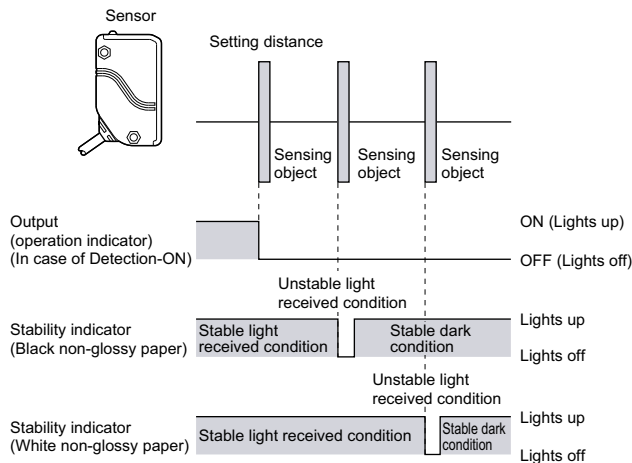
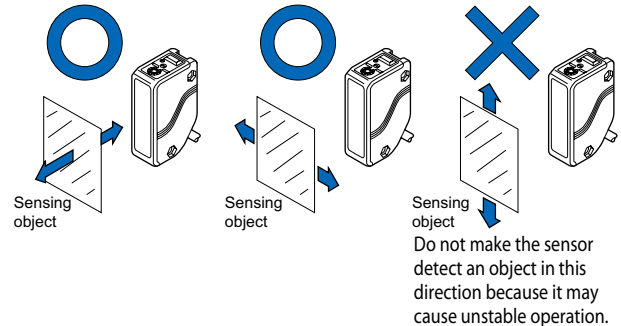

- When detecting a specular object (aluminum or copper foil) or an object having a glossy surface or coating, please take care that there are cases when the object may not be detected due to a small change in angle, wrinkles on the object surface, etc.
- When a specular body is present below the sensor, use the sensor by tilting it slightly upwards to avoid wrong operation.

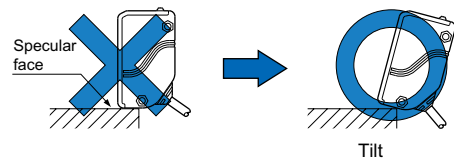

**Others**

- Do not use during the initial transient time (50 ms) after the power supply is switched on.
- When connecting the mating cable to the plug-in connector type, the tightening torque should be 0.4 N·m or less.

- If a specular body is present in the background, wrong operation may be caused due to a small change in the angle of the background body. In that case, install the sensor at an inclination and confirm the operation with the actual sensing object.
- Take care that some objects may produce a dead zone right (less than 0.1 m) in front of the sensor.

Selection Guide

Amplifier Built-in

**CX-400**

**EX-10**

**EX-20**

**EX-30**

**EX-40**

**EQ-30**

**EQ-500**

**MQ-W**

**RX-LS200**

**RX**

**CY**

**PX-2**

**RT-610**

Power Supply Built-in

**NX5**

**VF**

Amplifier-separated

**SU-7 / SH**

**SS-A5 / SH**

Other Products

## PRECAUTIONS FOR PROPER USE

Refer to p.986~ for general precautions.

### Distance adjustment

EQ-34W

&lt;Adjusters&gt;

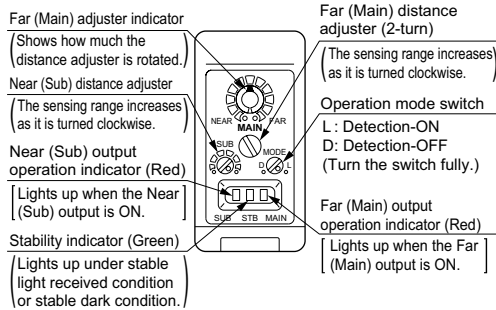

Adjusting procedure (when the direction of movement of the sensing objects is right or left to the sensor)

#### Far (Main)

Step	Description	Distance adjuster
①	Turn the Far (Main) distance adjuster fully counterclockwise to the minimum sensing range position of 0.2 m 0.656 ft approx.	Turn fully
②	Place an object at the far place at the required distance from the sensor, turn the Far (Main) distance adjuster gradually clockwise, and find out point (A) where the sensor changes to the light received condition.	
③	Remove the object, turn the Far (Main) distance adjuster further clockwise, and find out point (B) where the sensor changes to the light received condition again with only the background. (When the sensor does not go to the light received condition even if the adjuster is fully turned clockwise, point (B) is this extreme point in the range.)	
④	The optimum position to stably detect objects for the Far (Main) setting is the center point between (A) and (B)	

\*When a sensing object is approaching / moving away from the sensor, follow only steps ② and ③ respectively. Since the sensing point may change depending on the sensing object, be sure to check the operation with the actual sensing object.

#### Near (Sub)

Step	Description	Distance adjuster
⑤	Turn the Near (Sub) distance adjuster fully counterclockwise to the minimum sensing range position.	Turn fully
⑥	Place an object at the near position, at the required distance from the sensor, turn the Near (Sub) distance adjuster gradually clockwise, and find out point (C) where the sensor changes to the light received condition.	
⑦	Remove the object from the near position, and place the object for Far (Main) sensing at the sensing position. Turn the Near (Sub) distance adjuster further clockwise, and find out point (D) where the sensor changes to the light received condition again with only the background. (When the sensor does not go to the light received condition even if the adjuster is fully turned clockwise, point (D) is this extreme point..)	
⑧	The optimum position to stably detect objects for the Near (Sub) setting is the center point between (C) and (D)	

\*When a sensing object is approaching / moving away from the sensor, follow only steps ⑥ and ⑦ respectively. Since the sensing point may change depending on the sensing object, be sure to check the operation with the actual sensing object.

Notes: 1) Turn the distance adjuster gradually and lightly with the attached screwdriver. If the distance adjuster is over turned or pressed heavily, it may be damaged.  
2) The Far (Main) distance adjustment should be done before the Near (Sub) distance adjustment. Take care that the Near (Sub) setting distance changes with change in the Far (Main) setting distance.

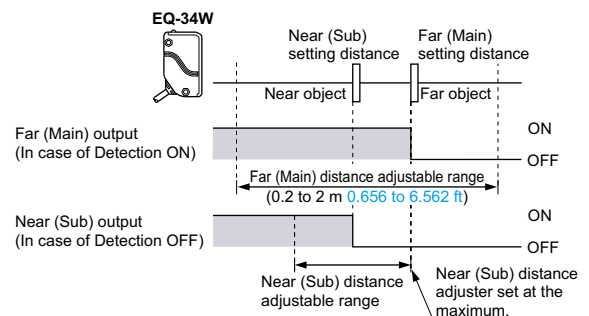

FIBER SENSORS

LASER SENSORS

PHOTO-ELECTRIC SENSORS

MICRO PHOTO-ELECTRIC SENSORS

AREA SENSORS

SAFETY COMPONENTS

PRESSURE SENSORS

INDUCTIVE PROXIMITY SENSORS

PARTICULAR USE SENSORS

SENSOR OPTIONS

WIRE-SAVING SYSTEMS

MEASUREMENT SENSORS

STATIC CONTROL DEVICES

LASER MARKERS

Selection Guide

Amplifier Built-in

CX-400

EX-10

EX-20

EX-30

EX-40

EQ-30

EQ-500

MQ-W

RX-LS200

RX

CY

PX-2

RT-610

Power Supply Built-in

NX5

VF

Amplifier-separated

SU-7 / SH

SS-A5 / SH

Other Products



**PRECAUTIONS FOR PROPER USE**

Refer to p.986~ for general precautions.

**EQ-34, EQ-34-PN**

<Adjusters>

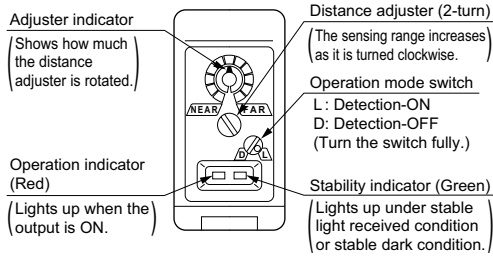

(Adjusting procedure (when the direction of movement of the sensing objects is right or left to the sensor))

Step	Description	Distance adjuster
①	Turn the distance adjuster fully counterclockwise to the minimum sensing range position of 0.2 m 0.656 ft approx.	Turn fully
②	Place an object at the required distance from the sensor, turn the distance adjuster gradually clockwise, and find out point A where the sensor changes to the light received condition.	
③	Remove the object, turn the distance adjuster further counterclockwise, and find out point B where the sensor changes to the light received condition again with only the background. (When the sensor does not go to the light received condition even if the adjuster is fully turned clockwise, point B is this extreme point in the range.)	
④	The optimum position to stably detect objects is the center point between A and B	

\*When a sensing object is approaching / moving away from the sensor, follow only steps ② and ③ respectively. Since the sensing point may change depending on the sensing object, be sure to check the operation with the actual sensing object.

Note: Turn the distance adjuster gradually and lightly with the attached screwdriver. If the distance adjuster is over turned or pressed heavily, it may be damaged.

**DIMENSIONS (Unit: mm in)**

The CAD data in the dimensions can be downloaded from the SUNX website: <http://www.sunx.com>

**EQ-34 EQ-34-PN** Sensor

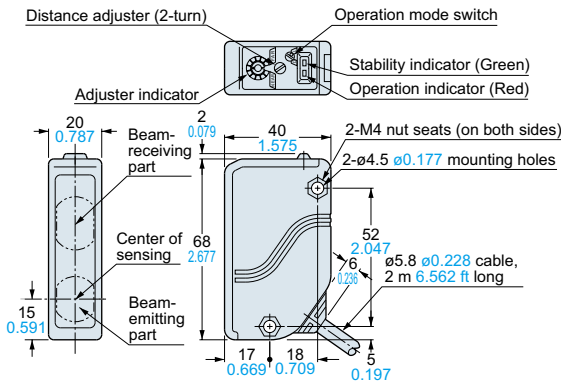

**EQ-34W** Sensor

