

## INSTRUCTION MANUAL

Photoelectric Sensor

Adjustable Range Reflective  
EQ-500 Series

Thank you very much for using SUNX products. Please read this Instruction Manual carefully and thoroughly for the correct and optimum use of this product. Kindly keep this manual in a convenient place for quick reference.



- Never use this product as a sensing device for personnel protection.
- In case of using sensing devices for personnel protection, use products which meet standards, such as OSHA, ANSI or IEC etc., for personnel protection applicable in each region or country.

### 1 SPECIFICATIONS

Type	Multi-voltage		DC-voltage	
	Model No.	Short sensing range	Model No.	Short sensing range
Item	EQ-501	EQ-502	EQ-511	EQ-512
Adjustable range (Note 1) (Note 2)	0.2 to 2.5m	0.2 to 1.0m	0.2 to 2.5m	0.2 to 1.0m
Sensing range (Setting distance maximum) (Note 2)	0.1 to 2.5m	0.1 to 1.0m	0.1 to 2.5m	0.1 to 1.0m
Hysteresis (Note 2)	10% or less of operation distance			
Supply voltage	24 to 240V AC ± 10% or 12 to 240V DC ± 10% Ripple P-P 10% or less		12 to 24V DC ± 10% Ripple P-P 10% or less	
Power / Current consumption	AC: 4VA or less (With timer: 5VA or less) DC: 3W or less (With timer: 4W or less)		45mA or less	
Output	Relay contact 1a • Switching capacity: 250V AC 3A (resistive load) 30V DC 3A (resistive load) • Electrical life: 100,000 or more operations (switching frequency 1,200 times/hour) • Mechanical life: 50,000,000 or more operations (switching frequency 18,000 times/hour)		NPN open-collector transistor • Maximum sink current: 100mA • Applied voltage: 30V DC or less (between output and 0V) • Residual voltage: 1V or less (at 100mA sink current) 0.4V or less (at 16mA sink current) PNP open-collector transistor • Maximum source current: 100mA • Applied voltage: 30V DC or less (between output and +V) • Residual voltage: 1V or less (at 100mA source current) 0.4V or less (at 16mA source current)	
Output operation	Switchable either Detection-ON or Detection-OFF			
Short-circuit protection	—		Incorporated	
Response time	20ms or less (Depends on the timer setting period for EQ-50□T)		2ms or less (Depends on the timer setting period for EQ-51□T)	
Operation indicator	Orange LED (lights up when the output is ON)			
Stability indicator	Green LED (lights up under stable operating condition)			
Distance adjuster	2-turn mechanical adjuster with pointer			
Sensing mode	—		Switch either BGS or FGS function	
Timer function	EQ-50□T: Selectable from ON-delay and OFF-delay (0.1 to 5 sec. variable)			
Automatic interference prevention function	Incorporated (Note 3)			
Protection	IP67 (IEC)			
Ambient temperature	-25 to +55°C (No dew condensation or icing allowed), Storage: -30 to +70°C			
Ambient humidity	35 to 85% RH, Storage: 35 to 85% RH			
Emitting element	Infrared LED (modulated)			
Receiving element	2-segment photodiode			
Material	Enclosure: ABS, Front cover: Polycarbonate, Display cover: Polycarbonate			
Connection method	Screw-on terminal connection			
Cable	Suitable for round cable φ9 to φ11mm			
Cable length	Extension up to total 100m is possible with 0.3mm <sup>2</sup> , or more, cable			
Weight	100g approx.		85g approx.	
Accessory	Adjusting screwdriver: 1 pc.			

- Notes: 1) The adjustable range stands for the maximum sensing range which can be set with the adjuster.  
 2) The adjustable range, the sensing range and the hysteresis are specified for white non-glossy paper (200×200mm) as the object.  
 3) When the sensors are mounted closely, use them in the interference prevented area, as shown below.

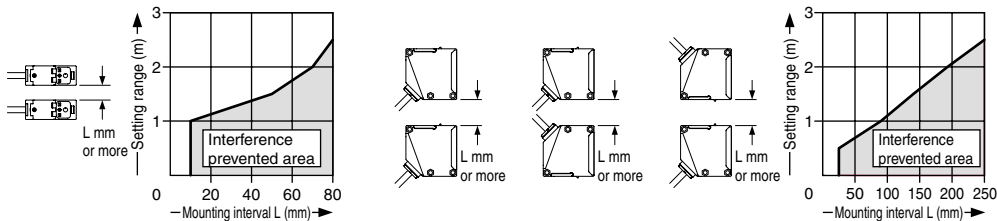

Note that the detection may be unstable depending on the mounting conditions or the sensing object. In the state where this product is mounted, be sure to check the operation with the actual sensing object to be used.

### 2 INFORMATION RELATING TO LOW VOLTAGE DIRECTIVE (Multi-voltage type only)

Item	Description
Referring standard	IEC 60947-5-2: 1998
Utilization category	AC-12/DC-12
Impulse withstanding voltage	2.5kV
Pollution degree	3
Frequency of operation cycle	25Hz
Turn off time	20ms
Excess gain	12%
Rated conditional protective device	100A
Short-circuit protective device	FUSE 5A FAST BLOW

Note: Each condition for use that the standards require is under less than 2,000m above sea level.

### 3 CAUTIONS

- Make sure that the power supply is off while wiring and adjusting.
- Take care that wrong wiring will damage the sensor.
- Verify that the supply voltage variation is within the rating.
- If power is supplied from a commercial switching regulator, ensure that the frame ground (F.G.) terminal of the power supply is connected to an actual ground.

- Do not run the wires together with high-voltage lines or power lines or put them in the same raceway. This can cause malfunction due to induction.
- In case noise generating equipment (switching regulator, inverter motor, etc.) is used in the vicinity of this product, connect the frame ground (F.G.) terminal of the equipment to an actual ground.
- Take care that the sensor is not directly exposed to fluorescent light from a rapid-starter lamp or a high frequency lighting device, as it may affect the sensing performance.
- If an external surge voltage exceeding 4kV (DC-voltage: 1kV) is impressed, the internal circuit will be damaged, and a surge suppressing element should be used.
- Do not use during the initial transient time (50ms) after the power supply is switched on.
- This sensor is suitable for indoor use only.
- A mechanical structure is employed for the distance adjuster of this product. Take care not to drop the product.
- Do not use this sensor in places having excessive vapor, dust, etc., or where it may come in direct contact with water, or corrosive gas.
- Take care that the sensor does not come in direct contact with water, oil, grease, or organic solvents, such as, thinner, etc.
- This sensor cannot be used in an environment containing inflammable or explosive gases.
- Never disassemble or modify the sensor.

### 4 MOUNTING

- The tightening torque should be 0.8N·m or less.

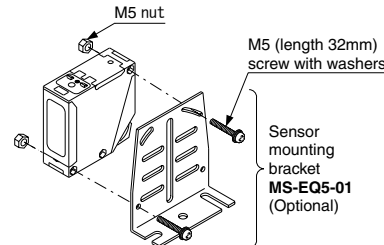

- Care must be taken regarding the sensor mounting direction with respect to the object's direction of movement.

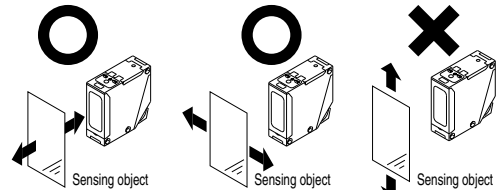

- When detecting a specular object (aluminum or copper foil, etc.) or an object having a glossy surface or coating, please take care that there are cases when the object may not be detected due to a small change in angle, wrinkles on the object surface, etc.

- When a specular body is present below the sensor, use the sensor by tilting it slightly upwards to avoid wrong operation.

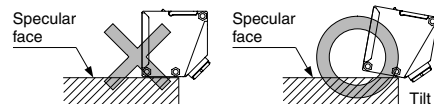

- If a specular body is present in the background, wrong operation may be caused due to a small change in the angle of the background body. In that case, install the sensor at an inclination and confirm the operation with the actual sensing object.
- This product is not easily affected by the reflected light intensity since this sensor is the adjustable range reflective type. When the reflected light intensity is remarkably low, the sensing range may be affected. In that case, mount the sensor, while checking light-up of the stable indicator (green).
- Mounting screws of the terminal cover and display cover should certainly be tightened to maintain the water tight rating, however, the tightening torque of the screws should be of 0.3 to 0.5N·m.

### 5 WIRING CONNECTIONS

- Check all wiring before applying power since incorrect wiring may damage the internal circuit. Also, carefully tighten the terminal screws so that the wires of adjacent terminals do not touch.

- The mounting hole for screw the terminal cover fixing inclines 70 degrees to the terminal cover, as shown in the figure below.

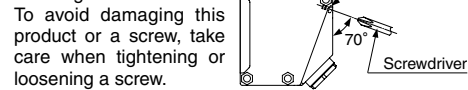

- To maintain a watertight performance, the cable should have an outer diameter between φ9 to φ11mm with a smooth covering material that allows the accessory conduit connector to be securely tightened, however, the tightening torque of the screw should be of 1.5 to 2.0N·m.

- Composition of a conduit connector, and processing of a cable

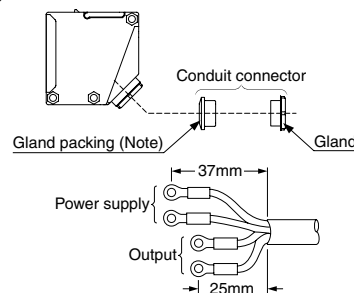

Note: When assembling the conduit connector, take care of the direction of the gland packing. Furthermore, in order to maintain a watertight performance, fit the gland packing such that the seating surface of the gland packing contacts the packing holder part of the terminal cover

- If pressure terminals are to be used, affix the connected pressure terminals to a terminal (M3.5 screw).
- **Dimensions of the suitable crimp terminals**

(Unit: mm)

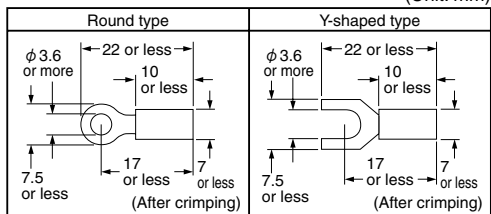

- The tightening torque of the terminal screws should be 0.3 to 0.5N·m.

## 6 I/O CIRCUIT DIAGRAMS

### ● Multi-voltage type

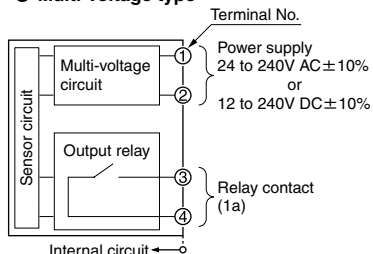

### ● DC-voltage type

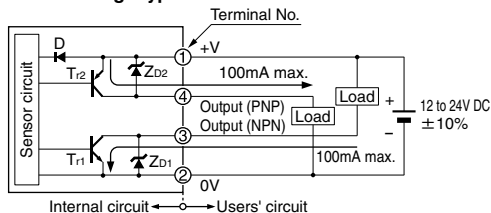

Symbols...D: Reverse supply polarity protection diode  
Zd1, Zd2: Surge absorption zener diode  
T1: NPN output transistor  
T2: PNP output transistor

### ● Terminal position

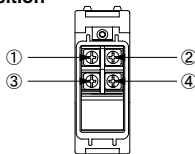

## 7 PART DESCRIPTION

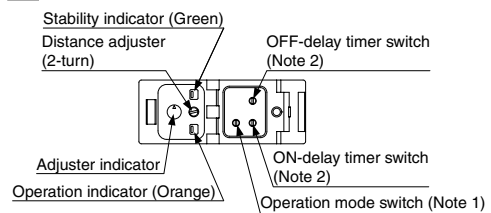

Notes: 1) The operation mode switch of the DC-voltage type is the DIP switch. Refer to '8 OPERATION MODE SWITCH' for details.  
2) Incorporated on EQ-5□T only.

## 8 OPERATION MODE SWITCH

### ● Multi-voltage type (L-ON / D-ON mode only)

Operation mode switch	Description
	Detection-ON mode is obtained when the switch is turned fully clockwise.
	Detection-OFF mode is obtained when the switch is turned fully counterclockwise.

Note: Turn the operation mode switch gradually and lightly with the attached screwdriver. If the distance adjuster is over turned or pressed heavily, it may be damaged.

### ● DC-voltage type

L-ON / D-ON mode	→ L	<input type="checkbox"/>	D
BGS/FGS mode	→ BGS	<input type="checkbox"/>	FGS
Timer mode	→ OFF	<input type="checkbox"/>	Timer ON
Not used	→ N.C.	<input type="checkbox"/>	N.C.

## 9 BGS/FGS FUNCTION (DC-voltage type only)

- This sensor incorporates BGS/FGS function. Select either BGS or FGS function depending on the positions of the background and sensing object. BGS/FGS function is set with the operation mode switch.
- Depends on a selection of either BGS or FGS function, the output operation changes as follows.

		Sensing range	Adjusted distance	ON	OFF
BGS	L-ON			ON	OFF
	D-ON			ON	OFF
FGS	L-ON			ON	OFF
	D-ON			ON	OFF

### <BGS function>

- This function is used when the sensing object is apart from the background.

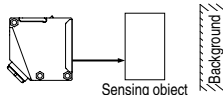

### <FGS function>

- This function is used when the sensing object contacts the background or the sensing object is glossy, etc.

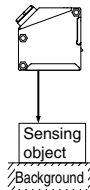

## 10 DISTANCE ADJUSTMENT

For DC-voltage type, be sure to set the BGS/FGS function before distance adjustment. If the setting is done after the distance adjustment, the sensing area is changed.

- Turn the distance adjuster gradually and lightly with a screwdriver (please arrange separately). In order to protect itself, the distance adjuster idles if turned fully.

### ● Multi-voltage type, DC-voltage type · BGS select

Step	Description	Distance adjuster
①	Turn the distance adjuster fully counterclockwise to the minimum sensing range position. (0.2m approx.)	
②	Please an object at the required distance from the sensor, turn the distance adjuster gradually clockwise, and find out point (A) where the sensor changes to the light received condition.	
③	Remove the object, turn the distance adjuster further clockwise, and find out point (B) where the sensor changes to the light received condition again with only the background. (When the sensor does not go to the light received condition even if the adjuster is fully turned clockwise, point (B) is this extreme point.)	
④	The optimum position to stably detect objects is the center point between (A) and (B).	

### ● DC-voltage type · FGS select

Step	Description	Distance adjuster
①	Turn the distance adjuster fully clockwise to the maximum sensing range position. (2.5m approx., 1.0m approx. for EQ-512□)	
②	In the state where the sensor detects the background, turn the distance adjuster gradually counterclockwise, and find out point (A) where the sensor changes to the undetecting condition.	
③	Place an object at the required distance from the sensor, turn the adjuster counterclockwise further until the sensor goes into the undetecting condition again. Once it has entered, turn the adjuster backward a little until the sensor returns to the detecting condition. That position is designated as point (B). (When the sensor does not go into the undetecting condition even if the adjuster is fully turned counterclockwise, the position where the adjuster was fully turned is regarded as the point (B).)	
④	The optimum position to stably detect objects is the center point between (A) and (B).	

## 11 STABILITY INDICATOR

- Since the EQ-500 series use a 2-segment photodiode as its receiving element, and sensing is done based on the difference in the incident beam angle of the reflected beam from the sensing object, the output and the operation indicator (orange) operate according to the object distance. Further, the stability indicator (green) shows the margin to the setting distance.

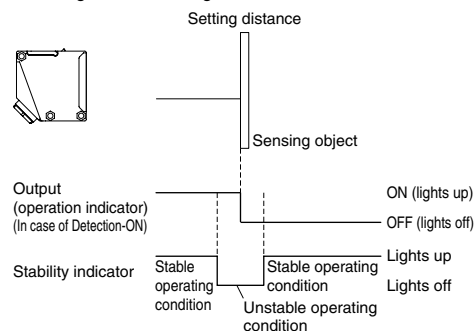

## 12 TIMER FUNCTION (EQ-5□T only)

- An OFF-delay timer, which is useful when the response of the connected device is slow, etc., an ON-delay timer, which is useful when the input specifications of the connected device require a signal of a fixed width, are possible with EQ-5□T.
- The OFF-delay timer and the ON-delay timer can be used at the same time.
- For DC-voltage type, set the DIP switch for the timer selecting to 'Timer ON' side.

### <Time chart>

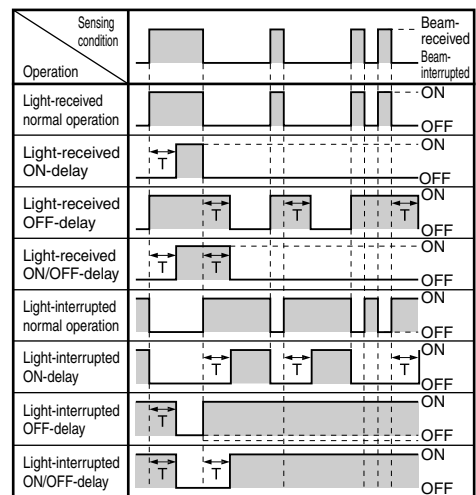

Timer period: T = 0.1 to 5s (variable)

Note: Turn the timer switch gradually and lightly with the attached screwdriver. If the distance adjuster is over turned or pressed heavily, it may be damaged.

## 13 DIMENSIONS (Unit: mm)

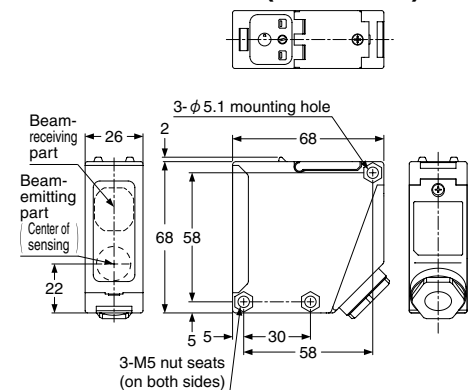

## SUNX Limited

<http://www.sunx.co.jp/>

### Head Office

2431-1 Ushiyama-cho, Kasugai-shi, Aichi, 486-0901, Japan

Phone: +81-(0)568-33-7211 FAX: +81-(0)568-33-2631

### Overseas Sales Dept.

Phone: +81-(0)568-33-7861 FAX: +81-(0)568-33-8591

PRINTED IN JAPAN