

# INSTRUCTION MANUAL

Sensor Option Handy Controller Exclusive for SF4C Series

## SFC-HC

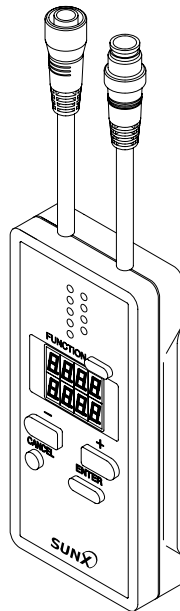

(MEMO)

Thank you for purchasing SUNX's Handy Controller **SFC-HC** exclusive for **SF4C** series.  
Please read both the instruction manual of this manual and **SF4C** series carefully and thoroughly for the correct and optimum use of this device.  
Kindly keep this manual in a convenient place for quick reference.

This manual has been written for the following personnel who have undergone suitable training and have knowledge of light curtains, as well as, safety systems and standards (ANSI, etc.).

- ◆ who are responsible for the introduction of this device
- ◆ who design a system using this device
- ◆ who install and connect this device
- ◆ who manage and operate a plant using this device

#### NOTICE



- 1) Drawings in this instruction manual may be little different with actual product. Please be forewarned.
- 2) The contents of this instruction manual may be changed without prior notice for further improvement of the device.
- 3) A part of / all of this instruction manual or the software may not be copied without permission from the publisher.
- 4) Though we have carefully drawn up the contents of this instruction manual, if there are any aspects that are not clear, or any error that you may notice, please contact our local SUNX office or the nearest distributor.
- 5) We shall not be responsible for any consequences of use regardless of the descriptions above.
- 6) English and Japanese versions of this instruction manuals are original.

# Contents

<b>CHAPTER 1 INTRODUCTION</b> .....	<b>4</b>
1-1 Attention Marks.....	4
1-2 Safety Precautions.....	4
<b>CHAPTER 2 GENERAL OUTLINE</b> .....	<b>6</b>
2-1 Features.....	6
2-2 Part Descriptions .....	6
2-3 Connecting / Setting Procedures .....	7
<b>CHAPTER 3 FUNCTIONS</b> .....	<b>9</b>
3-1 Functional Descriptions .....	9
3-1-1 Fixed Blanking Function.....	9
3-1-2 Floating Blanking Function.....	10
3-1-3 Auxiliary Output Switching Function.....	11
3-1-4 Muting Setting Changing Function.....	12
3-1-5 Override Setting Changing Function.....	14
3-1-6 Muting Lamp Diagnosis Function.....	14
3-1-7 Safety Input Setting Changing Function .....	14
3-1-8 Large Multi-purpose Indicator Setting Changing Function.....	15
3-1-9 Interlock setting changing function.....	16
3-1-10 External Device Monitor Setting Changing Function .....	16
3-1-11 Protective Function .....	16
3-1-12 Setting Contents Monitoring Function (Only for Ver. 2.0 or later of <b>SF4C</b> series).....	16
3-1-13 Copy Function (Only for Ver. 2.0 or later of <b>SF4C</b> series).....	17
3-1-14 Initialization Function .....	17
3-2 Function Setting (Operation Procedure).....	18
3-2-1 Fixed Blanking Function.....	20
3-2-2 Floating Blanking Function.....	21
3-2-3 Auxiliary Output Switching Function.....	22
3-2-4 Muting Setting Changing Function.....	23
3-2-5 Override Setting Changing Function.....	26
3-2-6 Muting Lamp Diagnosis Function.....	27
3-2-7 Safety Input Setting Changing Function .....	28
3-2-8 Large Multi-purpose Indicator Setting changing Function .....	29
3-2-9 Interlock Setting Changing Function.....	30
3-2-10 External Device Monitor Setting Changing Function .....	31
3-2-11 Protective Function .....	32
3-2-12 Setting Contents Monitoring Function (Only for Ver. 2.0 or later of <b>SF4C</b> series).....	33
3-2-13 Copy Function (Only for Ver. 2.0 or later of <b>SF4C</b> series).....	35
3-2-14 Initialization Function .....	37
<b>CHAPTER 4 TROUBLESHOOTING</b> .....	<b>38</b>
<b>CHAPTER 5 SPECIFICATIONS / DIMENSIONS</b> .....	<b>39</b>
5-1 Specifications.....	39
5-2 Dimensions .....	39

# CHAPTER 1 INTRODUCTION

## 1-1 Attention Marks

This instruction manual employs the following attention marks  **WARNING**,  **CAUTION** depending on the degree of the danger to call operator's attention to each particular action. Read the following explanation of these marks thoroughly and observe these notices without fail.

Besides, the attention mark is prepared for the helpful information, detail instruction related to each part, and reference item or page



**WARNING**

If you ignore the advice with this mark, death or serious injury could result.



**CAUTION**

If you ignore the advice with this mark, injury or material damage could result.



Remarks

The supplementary content is described with this mark.



REFERENCE  The related content is described with this mark.

## 1-2 Safety Precautions

- Use this device as per its specifications. Do not modify this device since its functions and capabilities may not be maintained and it may malfunction.
- This device has been developed / produced for industrial use only.
- Before using this device, check whether the device performs properly with the functions and capabilities as per the design specifications.
- In case of disposal, dispose this device as industrial waste.



**WARNING**

### ◆ User in charge

- The user in charge has responsible to indicate the person to take the training required for the safety system, using method, installation, operation, and maintenance.
- This device is used and managed by the specialist, never use this device by other operator.

### ◆ Specialist

- A person who is appropriately educated, has widespread knowledge and experience, and can solve various problems which may arise during work.

### ◆ Operator

- The operator should read this instruction manual thoroughly, understand its contents, and perform operations following the procedures described in this manual, for the correct operation of this device.
- In case this device does not perform properly, the operator should report this to the person in charge and stop the machine operation immediately. The machine must not be operated until correct performance of this device has been confirmed.

### **WARNING**

#### ◆ **Fixed blanking function, floating blanking function**

- With the fixed blanking function, this device prevents the person or object from entering into the dangerous parts of the machine through the invalid sensing area. However, even though this device can prevent the interference of the person or object into the invalid sensing area with the fixed blanking function, there might exist the more space between the **SF4C** series and already-existence object. Therefore, set the protecting structure so as not to exist any space in the dangerous sensing area. Detecting human body in the sensing area could result in death or serious injury.
- With the floating blanking function, this device changes the size of the minimum sensing object of the **SF4C** series that is pre-set the function. When setting or changing the function, calculate and measure the safety distance again, and check that the device has the wider space than the safety distance between the dangerous parts of the machine and the sensing area of the **SF4C** series. If the sufficient distance is not maintained, the machine will not stop before its dangerous parts are reached, which can result in death or serious injury.
- Set and change the function of the device following the relative laws, regulation, and standard without fail.

#### ◆ **Muting setting changing function**

- The muting setting changing function temporarily invalidates safety function of the connected devices. Confirm all of the applied laws and standards, and install or operate this device and peripheral devices correctly. Failure to do so, the operator may suffer a serious injury.

#### ◆ **Environment**

- Do not use a mobile phone or a radio phone near this device.
- Do not use this device in the following environments.
  - 1) Areas with high humidity where condensation is likely to occur
  - 2) Areas exposed to corrosive or explosive gases
  - 3) Areas exposed to vibration or shock of high levels
  - 4) Areas exposed to contact with water
  - 5) Areas exposed to too much steam or dust

#### ◆ **Wiring**

- Be sure to carry out the wiring in the power supply OFF condition.
- All electrical wiring should conform to the regional electrical regulations and laws. The wiring should be done by engineer(s) having the special electrical knowledge.
- Do not run the wires together with high-voltage lines or power lines or put them in the same raceway. This can cause malfunction due to induction.

#### ◆ **Maintenance**

- Clean this device with a clean cloth. Do not use any volatile chemicals.

#### ◆ **Other**

- Never reassemble or remodel this device.

# CHAPTER 2 GENERAL OUTLINE

This chapter gives the system construction, part description, etc. of this device.

## 2-1 Features

This device is the handy controller for setting each function of the light curtain **SF4C** series.

Besides, this device performs the checking and copying the setting contents of the function, and protection of writing.

### <Functions>

- Fixed blanking function
- Floating blanking function (Invalid setting of both end beam channels can be set in Ver. 2.1 of **SF4C** series only)
- Auxiliary output switching function
- Muting setting changing function  
(Muting sensor output operation setting can be set in Ver. 2.1 of **SF4C** series only)
- Override setting changing function
- Muting lamp diagnosis function
- Safety input setting changing function  
(Invalid setting can be set in only Ver. 2.0 or later of **SF4C** series)
- Large multi-purpose indicator setting changing function
- Interlock setting changing function
- External device monitor setting changing function
- Protective function
- Setting contents monitoring function  
(Can be set in only Ver. 2.0 or later of **SF4C** series)
- Copy function  
(Can be set in only Ver. 2.0 or later of **SF4C** series)
- Initialization function

Indicated place of Ver. information of **SF4C** series

<Plate of emitter side>

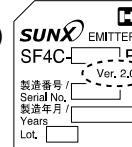

<Plate of receiver side>

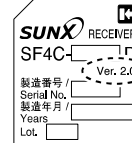

For Ver. 2.0 or later of **SF4C** series.  
Not indicated in Ver. 1.0 of **SF4C** series.

## 2-2 Part Descriptions

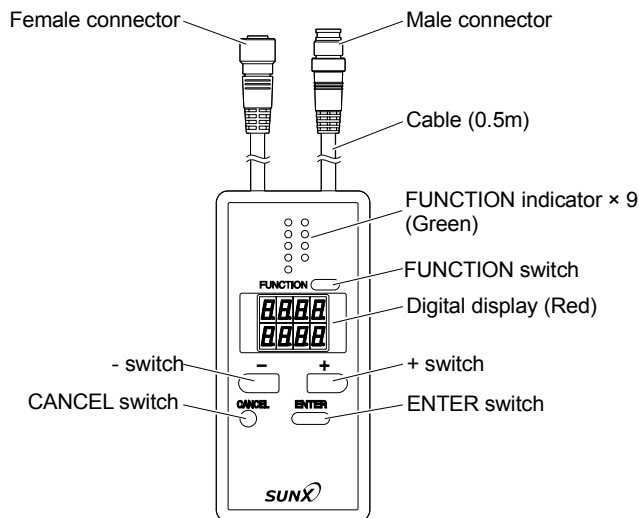

### 2-3 Connecting / Setting Procedures

This section describes the connecting / setting procedures for both this device and **SF4C** series.

#### <In case using intermediate connector type to this device>

1. Set the **SF4C** series, and check that the **SF4C** series works properly. For mounting method of **SF4C** series, refer to the respective Instruction Manuals.
2. Turn OFF the power, and disconnect the extension cable with connectors connected to **SF4C** series, then connect this device between emitter (or receiver) of **SF4C** series and the extension cable with connectors.

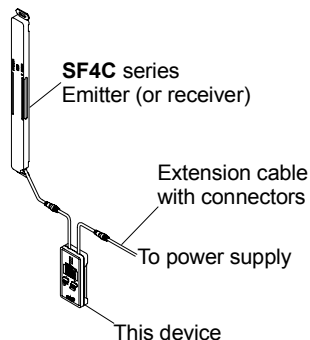
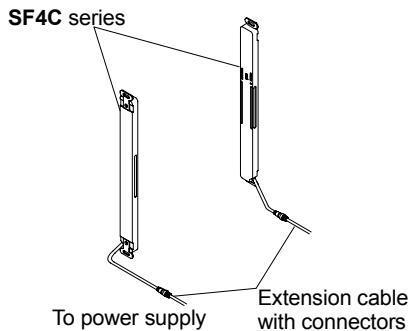

3. Turn ON the power, and set the function with this device.  
After the power of this device turned ON, approx. 10 sec. will be taken for data transmission with **SF4C** series. While data transmission, “**J**” lights up in revolving.  
[The control output (OSSD 1 / 2) of **SF4C** series is set to “OFF” while this device has been connected.]  
In case of confirming operation of changed setting contents of **SF4C** series, turn OFF and turn ON of the power supply of **SF4C** series once.

#### CAUTION

- In case control is set as shutting OFF power of **SF4C** series from the power supply when the control output 1 / 2 (OSSD 1 / 2) becomes OFF, supply power from another power supply.
- Do not turn OFF or disconnect wires during setting. In case power is shut OFF during setting contents, set the contents again after initialization.
- When “good” in the check result after changing setting is displayed, the setting is fixed. In case the “good” is not displayed, set the setting contents again.

REFERENCE ➤➤ Refer to “**3-1 Functional Descriptions**” for the details of the functions, and refer to “**3-2 Function Setting (Operation Procedure)**” for the setting procedures of the functions respectively.

4. Turn OFF the power of emitter and receiver of **SF4C** series, then remove this device.
5. Connect both **SF4C** series and the extension cable with connectors and return the device to the state described in procedure 1.
6. Turn ON the power of emitter and receiver of **SF4C** series, and check that the **SF4C** series works as set at the procedure 3.  
Then, inspect the **SF4C** series.

REFERENCE ➤➤ Refer to “**Chapter 4 Maintenance**” of the **SF4C** series instruction manual for the details of the inspection of the **SF4C** series.



### <In case using this device with cable type of SF4C series>

- Wire a discrete connection cable with connector on one end **SFC-WNC1** (optional) to this device. And wire a clip of the discrete connection cable with connector on one end to a lead wire of cable type of **SF4C** series.
- It is also possible to use in condition that an intermediate connector type of **SF4C** series is wired to a cable with connector on one end **SFB-CC□-MU** (optional).

#### <For PNP output>

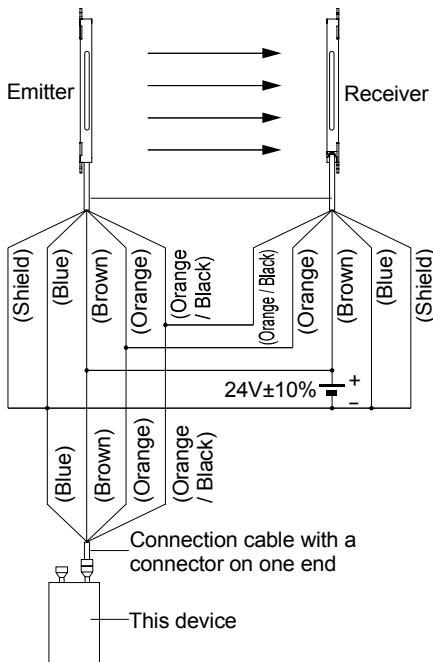

#### <For NPN output>

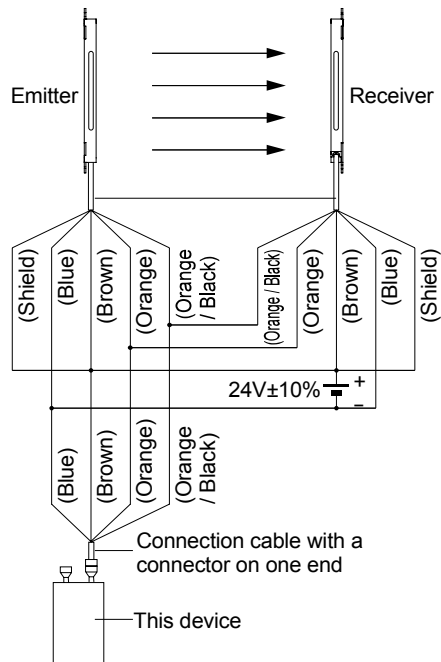

#### • Connection cable with a connector on one end: 1 pc./set

Model No.	Cable length	Description
<b>SFC-WNC1</b>	3m	Cable which incorporates clips on end of the discrete wire.

- The setting procedure remains the same.
- The control output (OSSD 1 / 2) of **SF4C** series is set to "OFF" while this device has been connected. Once the setting is completed, turn OFF the power, remove this device and then turn ON the power again.

### **CAUTION**

- When the lead wire contacts with other lead wires, maximally 26.4V DC of voltage is applied and 3A of current flows.
- In case the connecting cable with connector on one end connected the cable type of SF4C series or the intermediate connector type to this device, lead wire may be disconnected. Be sure the lead wire is not disconnected.

# CHAPTER 3 FUNCTIONS

## 3-1 Functional Descriptions

### ⚠ CAUTION

If configuration of the system is changed (replace the **SF4C** series etc.), set the function again.

### 3-1-1 Fixed Blanking Function

This is a function that the control output (OSSD 1 / 2) of **SF4C** series is not turned OFF, even if the specified beam channel(s) is blocked OFF.

This is useful when an obstacle always blocks OFF the specific beam channel(s).

There are “Clear,” “Auto” and “Manual” for the setting method.

- Clear setting : The fixed blanking function is to be invalid (factory setting).
- Auto setting : The currently blocked OFF beam channels are set as “valid beam channels” in the fixed blanking function. Be sure to set this function in the state where the emitter emits light. Furthermore, this function cannot be set in the state where all beam channels receive lights / are blocked.
- Manual setting : Each beam channel can be set to “valid / invalid” in the fixed blanking function respectively.  
The all light beam channel can not be selected all valid / all invalid

### ⚠ WARNING

When the fixed blanking function is used, the control output (OSSD 1 / 2) of **SF4C** series is not turned OFF even if the particular beam channels are blocked.

By using a protection structure etc., make the dangerous parts of the machine inaccessible to personnel through the sensing area of the particular beam channels.

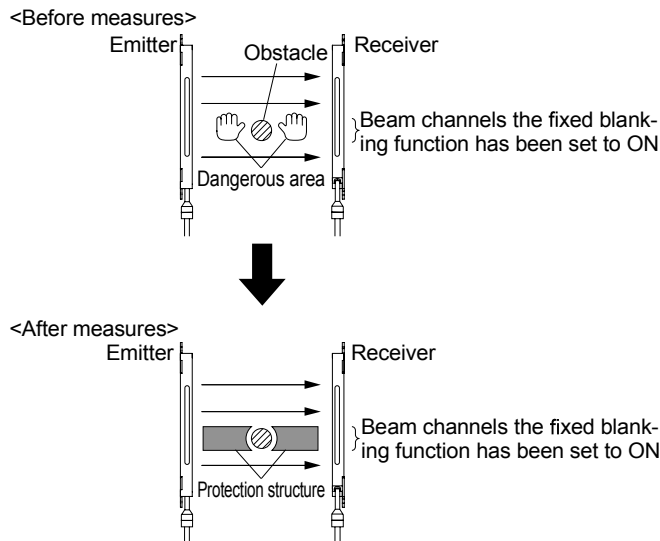

### ⚠ CAUTION

When the valid beam channel(s) in the fixed blanking function receive(s) the beam(s) from the emitter, the control output (OSSD 1 / 2) of the **SF4C** series is fixed to “OFF.” In this case, check the mounting condition and turn the power ON again.

(Even if the power is turned ON again, the fixed blanking function still stays valid.)

When the fixed blanking function is used, the received light intensity indicator of **SF4C** series is turned OFF regardless of the received light intensity.

## 3-1-2 Floating Blanking Function

If the number of the blocked beam channels is less than the set number of the beam channels, the control output (OSSD 1 / 2) of **SF4C** series is not turned "OFF."

This function is useful when an obstacle moves within the sensing area.

The factory setting of this function is "invalid."

The following items can be set.

### Set number of beam channels

- Selectable among 0 (the floating blanking function is invalid), 1, 2 or 3.

### Invalid setting of both end beam channels (only for Ver. 2.1 of SF4C series)

- Be able to select valid or invalid of floating blanking function in both ends of beam channels.
  - SET (Valid) : The floating blanking function becomes invalid at both ends of beam channels. In case either end of the beam channel is blocked, the control output (OSSD 1 / 2) of **SF4C** series is turned "OFF" regardless of the set number of the beam channels.
  - CLR (Invalid) : The floating blanking function becomes effective for all beam channels including both end beam channels.

### Non-serial beam channel setting

- SET (Valid) : Even if the beam channels are blocked discontinuously in the set beam channels, the control output (OSSD 1 / 2) of **SF4C** series is turned "ON." (Discontinuous mode)
- CLR (Invalid) : When the beam channels are blocked discontinuously even in the set beam channels, the control output (OSSD 1 / 2) of **SF4C** series is turned "OFF." (Continuous mode)



- When using the floating blanking function, the size of the minimum sensing object becomes larger, and the safety distance is longer as well. For the calculation of the safety distance, refer to the instruction manual enclosed with **SF4C** series.
- Before designing the system, refer to the relevant laws and standards of the region where **SF4C** series is to be used and then install **SF4C** series.
- The minimum sensing object differs depending on the set number of the beam channels.

**[For use in Europe (EU) (as EN 999)] (Also applicable to ISO 13855 / JIS B 9715)**

**(For intrusion direction perpendicular to the sensing area)**

**<In case that the minimum sensing object is over ø40mm>**

- Equation  $S = K \times T + C$

S : Safety distance (mm)

Minimum required distance between the sensing area surface and the dangerous parts of the machine.

K : Intrusion velocity of operator's body or object (mm/sec.)

Taken as 1,600 (mm/sec.) for calculation

T : Response time of total equipment (sec.)

$T = T_m + T_{SF4C}$

$T_m$ : Maximum halting time of machine (sec.)

$T_{SF4C}$ : Response time of **SF4C** series (sec.)

C : Additional distance (mm)

C = 850 (mm)

**<Minimum sensing object>**

	Floating blanking function			
	Invalid	Valid		
		1 beam channel	2 beam channels	3 beam channels
<b>SF4C-H□, SF4C-H□-J05</b>	ø25mm	ø45mm	ø65mm	ø85mm



If the floating blanking function is used, the incident light intensity indicator is turned OFF when an obstacle exists in the sensing range regardless of the incident light intensity.

# Functional Descriptions

## 3-1-3 Auxiliary Output Switching Function

This function changes the operation state of the auxiliary output. It is useful when desired to make an indicator to operate or inform the operation state of the **SF4C** series to PLC.



### WARNING

The auxiliary output is a non-safety output. Therefore, do not use the auxiliary output for the purpose of stopping the machine that the **SF4C** series is installed. Failure to do so could result in death or serious injury.

The following settings are selectable.

Setting mode	Auxiliary output setting	Operation of the auxiliary output corresponding to <b>SF4C</b> series state					
		When test input is valid	State of sensing area when test input is invalid			When safety input is valid	Lock-out
			Unshielded		Shielded		
			Unstable light-receiving condition	Others			
0	Negative logic of the control output (OSSD 1 / 2) (factory setting)	ON	OFF when OSSD is ON ON when OSSD is OFF			–	ON
1	Positive logic of the control output (OSSD 1 / 2)	OFF	ON when OSSD is ON OFF when OSSD is OFF			–	OFF
2	OFF when test output is valid	OFF	ON			–	–
3	ON when test output is invalid	ON	OFF			–	–
4	OFF under unstable light receiving condition (Note 1)	(Note 3)	OFF	ON	(Note 3)	–	(Note 3)
5	ON under unstable light receiving condition (Note 1)	(Note 3)	ON	OFF	(Note 3)	–	(Note 3)
6	ON during muting	OFF	ON during muting Others: OFF			–	OFF
7	OFF during muting	ON	OFF during muting Others: ON			–	ON
8	ON in light receiving condition (Note 2)	–	ON		OFF	–	OFF
9	OFF in light receiving condition (Note 2)	–	OFF		ON	–	ON
10	ON during safety input valid	–	–	–	–	ON	–
11	OFF during safety input valid	–	–	–	–	OFF	–
12	OFF during lockout	–	–	–	–	–	OFF
13	ON during lockout	–	–	–	–	–	ON

Notes: 1) When the fixed blanking function, the floating blanking function or the muting function is used, the setting of ON / OFF under unstable light-receiving condition does not work.

2) By the setting of ON / OFF in light receiving condition, light-receiving / light interrupted condition is output regardless of the fixed blanking function, the floating blanking function or the muting function.  
<e.g.>

When the fixed blanking function is used, if an obstacle exists in the set area and other area is in light receiving condition, the control output (OSSD 1 / 2) is in ON state, however, the auxiliary output becomes OFF since the **SF4C** series has been detecting the obstacle.

3) The state of the auxiliary output remains the same even if the **SF4C** series state changes.

## 3-1-4 Muting Setting Changing Function

The setting of the muting function can be changed.

### Setting of the muting function on each beam channel

- Each beam channel can be set to “valid / invalid” in the muting function respectively. (Note)  
All beam channel can not be all invalid.  
The factory setting of this function is valid for all beam channels.

Note: If the beam channel set to invalid in the muting function is blocked, the control output (OSSD 1 / 2) becomes “OFF” and the muting function is canceled.

- There are two setting methods, “Auto” and “Manual” to set muting beam channel.
  - Auto setting : The beam channel which is currently blocked is set as the “valid” beam channel. When all beam channels are in light receiving condition, the setting is not accepted. Furthermore, in the state that all beam channels are blocked, the all beam channels become “valid” in the muting function.
  - Manual setting: Each beam channel can be set to “valid / invalid” in the muting function.  
ON: The muting function is valid  
OFF: The muting function is invalid

### Muting maximum continuous valid time setting

- Maximum continuous valid time setting for muting function can be changed.  
The maximum continuous valid time is 1 to 600 sec. (1 sec. unit) or no limit.

### Muting sensor output operation setting (only for Ver. 2.1 of SF4C series)

- Output operation of muting sensor can be selected  
Factory setting is NONO (Normally Open • Normally Open)
  - **NONO (Normally Open, Normally Open)**  
A muting sensor which is to be connected to the muting input 1  
(ON with light non-received status, ON with object approaching status and ON with object contacted status)  
A muting sensor which is to be connected to the muting input 2  
(ON with light non-received status, ON with object approaching status and ON with object contacted status)
  - **NONC (Normally Open, Normally Close)**  
A muting sensor which is to be connected to the muting input 1  
(ON with light non-received status, ON with object approaching status and ON with object contacted status)  
A muting sensor which is to be connected to the muting input 2  
(ON with light received status, ON with object non-approaching status and ON with object non-contacted status)

### Muting function only for the sensing object exit

- Muting function only for the sensing object exit can be set.  
When setting to the muting function only for the sensing object exit, install the muting sensor only in the dangerous zone and the installation in the safety zone is not required.  
Using conditions of the muting function only for the sensing object exit is as follows.
  - The sensing object should move to one side.  
(The sensing object should move from the dangerous zone to the safety zone.)
  - The sensing object should pass through the sensing area within 4 sec. after the muting sensor turns OFF. (Note)

Note: Muting time only for the sensing object exit can be set between 0 (Invalid) to 4,000ms (Unit: 100ms).



In case using the muting function only for the sensing object exit and the floating blanking function, set by being sure listed below.

- The set beam channel number of the floating blanking function is 0 or 1 beam channel only.
- In case making valid the invalid setting of both end beam channels of the floating blanking function, set invalid the muting function of both ends of beam channels in each beam channel setting of muting function.

## Functional Descriptions

### Installation condition example of muting sensors when setting the muting function only for the sensing object exit

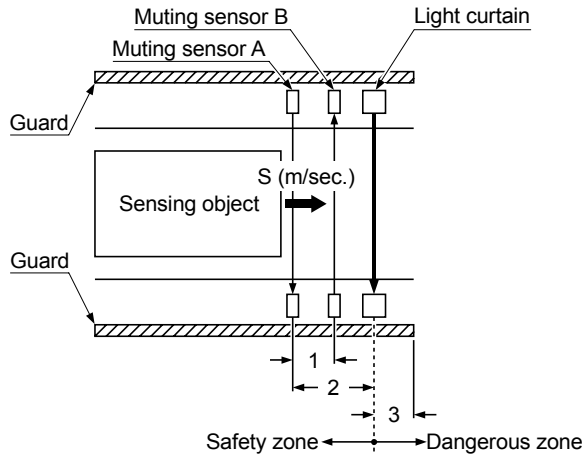

1. The time of the sensing object to be passed through the muting sensors A to B shall be 0.03 to under 3 sec.  
 Distance between A and B (m) <  $S \text{ (m/sec.)} \times 3 \text{ (sec.)}$   
 S: The moving speed (m/sec.) of the sensing object
2. The time of the sensing object to be passed through the muting sensor A to the light curtain shall be under 4 sec.  
 Distance between muting sensor A and the light curtain (m) <  $S \text{ (m/sec.)} \times 4 \text{ (sec.)}$   
 Distance between muting sensor A and the light curtain (m) < Total length of the sensing object (m)  
 S: The moving speed (m/sec.) of the sensing object
3. The time of the sensing object to be passed through the light curtain to the end of guard zone shall be under 4 sec.  
 Distance between the light curtain and the end of guard zone (m) <  $S \text{ (m/sec.)} \times 4 \text{ (sec.)} - 0.2$   
 S: The moving speed (m/sec.) of the sensing object

Note: If a beam channel whose muting function is set to be invalid is blocked during the muting, the control output (OSSD 1 / 2) will be turned OFF and the muting function will be released.

#### Muting input conditions

◆ The order for inputting the muting input 1 and 2, which the muting function activates, can be set.

- 1 = 2: Valid even either muting input 1 or muting input 2 comes first
- 1 2: Valid only when the muting input 1 comes first
- 2 1: Valid only when the muting input 2 comes first

Note: The setting is possible for each beam channel.

Remarks

Combination of using muting input conditions and setting of each beam channel of the muting function allows to set making muting function valid when muting input conditions are 1 to 2 or 2 to 1.

The setting method is to set the each beam channel setting of muting input condition 1 to 2 and set the each beam channel setting of muting input condition 2 to 1.

## 3-1-5 Override Setting Changing Function

Maximum continuous valid time set at the override function can be changed.  
 The maximum continuous valid time can be set in the range of 1 to 600 sec. (in units of 1 sec.).  
 The factory setting is 60 sec.

## 3-1-6 Muting Lamp Diagnosis Function

The muting lamp diagnosis function can be set to "valid / invalid." (Note)  
 The factory setting of this function is valid.

- ON : The muting lamp diagnosis function is valid.
- OFF: The muting lamp diagnosis function is invalid.

Note: If the muting lamp diagnosis function is set to invalid, the muting function is maintained even if the lamp blew.

## 3-1-7 Safety Input Setting Changing Function

This function enables to select the safety contacting point input mode or the safety sensor input mode with this controller. Furthermore, safety input can be set to invalid for Ver. 2.0 or later of **SF4C** series.

- **Safety contacting point input mode**  
 A safety contacting point can be connected. It is at the time of factory setting
- **Safety sensor input mode**  
 A safety sensor can be connected.

### <Output operations of a safety contacting point and a safety sensor>

	NC (Normally Closed) type	Operation at ON state	Operation at OFF state
Safety contacting point	ON with object non-contacted status (Emergency stop switch, etc.)	PNP output: Connect to +V NPN output: Connect to 0V	Open (Note)
Safety sensor	ON with light received status (Light curtain, etc.) ON with object non-approaching status (Safety switch, etc.)		

Note: the safety contacting point which is connected to the safety input 1 / 2 or safety sensor and control output of **SF4C** series should be kept OFF.

- **Invalid (only for Ver. 2.0 or later of SF4C series)**  
 Safety input can be invalid. In this case, safety contact point and safety sensor cannot be connected.



## WARNING

- Use 0.2mm<sup>2</sup> or more shielded cable when connecting other **SF4C** series cable to the safety input 1 / 2.
- When extending the cable of other **SF4C** series which is connected to the safety input 1 / 2, use the exclusive cable and the total cable length should be 40.5m or less (for each emitter / receiver). If the total cable length is exceeding 40.5m, the device may malfunction, resulting in death or serious injury.
- Response time of safety sensor is sum of a response time of this device and safety sensor itself.

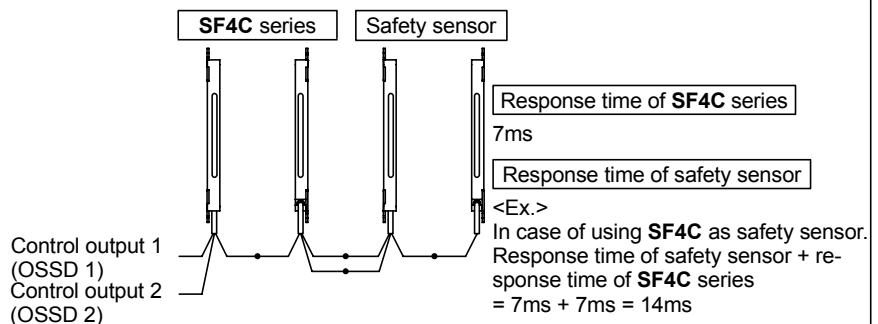

## Functional Descriptions

### CAUTION

- When using the device in PNP output (or NPN output), use PNP output (or NPN output) safety sensor. The control output (OSSD 1 / 2) becomes OFF by using wrong output type of sensor.
- Series connection is also available when connecting other **SF4C** series to the safety input 1 / 2. However, this device does not incorporate the interference prevention function. Thus, take sufficient care when installing the devices.
- Use a safety sensor which incorporates a crossover short-circuit function in the control output and connect both the safety input 1 wire (gray) and the safety input 2 wire (gray / black). Take care that if only one wire is connected, the device may not operate normally.
- Use a safety contacting point which incorporates two NC (Normally Closed) contacting points and connect both the safety input 1 wire (gray) and the safety input 2 wire (gray / black). Take care that if only one wire is connected, the device may not operate normally.
- In case setting the safety contacting point input mode or the safety sensor input mode, connect to +V or 0V as a following table when safety input function is not used.

Safety input setting changing function	For PNP output		For NPN output	
	Safety input 1 wire (gray)	Safety input 2 wire (gray / black)	Safety input 1 wire (gray)	Safety input 2 wire (gray / black)
Safety contacting point input mode	Connect to +V	Connect to 0V	Connect to +V	Connect to 0V
Safety sensor input mode	Connect to +V	Connect to +V	Connect to 0V	Connect to 0V

### 3-1-8 Large Multi-purpose Indicator Setting Changing Function

One mode can be selected from the following 8 modes

Factory setting is mode 0.

Mode	Operation of large multi-purpose indicator							
	Large multi-purpose indicator input 1		Large multi-purpose indicator input 2		Control output 1 / 2 (OSSD 1 / 2)		Muting function	Override function
	PNP output: High	NPN output: Low	PNP output: Low	NPN output: High	ON	OFF	Valid	Valid
0	Lights up in red		Lights up in green		–	–	–	–
1	Blinks in red		Blinks in green		–	–	–	–
2	Lights up in red		Blinks in green		–	–	–	–
3	Blinks in red		Lights up in green		–	–	–	–
4 (Note 1)	Lights up in red		Blinks in red		–	–	–	–
5 (Note 1)	Blinks in green		Lights up in green		–	–	–	–
6 (Note 1)	–		–		Lights up in green	Lights up in red	Blinks in green	–
7 (Note 1)	Lights up in red		Blinks in red		–	–	Lights up in green	Blinks in green

Notes: 1) Blinking takes precedence in case of same color blinks or light up in the large multi-purpose indicator.

2) The large multi-purpose indicator (red) and the large multi-purpose indicator (green) can be lit up and blinked in same time.

Furthermore, large multi-purpose indicator (red) can be blinked in lockout status.

Lockout blinking display function	Lockout ON
Valid	Blinks in red
Invalid	–



### 3-1-9 Interlock setting changing function

It is selectable one interlock state among the following three interlock settings (Mode 3)

- **Start / Restart interlock (Mode 0)**  
SF4C series goes into the interlock state after the power is turned ON, or when the light of SF4C series is blocked.  
The factory setting is start / restart interlock.
- **Start interlock (Mode 1)**  
SF4C series goes into the interlock state when the power supply is turned ON. Once this interlock is reset, the device does not go into the interlock state.
- **Restart interlock (Mode 2)**  
SF4C series does not go into the interlock state when turning ON the power supply. Only when the control output (OSSD 1 / 2) becomes ON and the light for SF4C is blocked after the power is turned ON and this device receives the light, the device goes into the interlock state.

### 3-1-10 External Device Monitor Setting Changing Function

The setting of the external device monitor can be changed

1. Allowable time for response time: 100 to 600ms (Unit: 10ms)  
Factory setting is 300ms.
2. The external device monitor function can be selected to valid or invalid  
The factory setting is set to valid for the external device monitor function.

### 3-1-11 Protective Function

The functional settings are not allowed to change without the input of a password of SF4C series. When the protective function is set to "valid," the setting can be changed by inputting the password. The setting contents monitor function can be used regardless of the protective function "valid / invalid." The password should be a 4-digit number from 0 to 9. (The password of the factory setting is "0000.") The protective function is set on the receiver.

#### CAUTION

- When the protecting function is set to "invalid," the third person may change the setting. It is recommended that the protecting function should be set to "valid" so as not to change the setting by the third person.
- Take sufficient care not to forget the set password. In case you forget the password, please contact us.

### 3-1-12 Setting Contents Monitoring Function (Only for Ver. 2.0 or later of SF4C series)

Each setting of the SF4C series can be monitored. The following can be monitored.

- Setting of the fixed blanking function (Reading out the record of the latest 5 times is possible)
- Setting of the floating blanking function (Reading out the record of the latest 5 times is possible)
- Setting of the auxiliary output switching function
- Setting of the muting setting changing function  
(Reading out the record of the latest 5 times is possible, however, only for setting beam channel.)
- Setting of the override setting changing function
- Setting of the muting lamp diagnosis function
- Setting of the safety input setting changing function
- Setting of the large multi-purpose indicator setting changing function
- Setting of the interlock setting changing function
- Setting of the external device monitor setting changing function
- Setting of the protect function
- Model No. / the number of beam channels of SF4C series.

# Functional Descriptions

## 3-1-13 Copy Function (Only for Ver. 2.0 or later of SF4C series)

This is a function to copy the setting of a SF4C series to other SF4C series. This function is available only under the same system configuration (the number of beam channels, same model No.).

All functions that can be set with this device can be copied.

Note that the password is also copied with this function.

The following operations are available with this function.

- Upload : Upload the functional setting data of SF4C series to this device.
- Download : Download the functional setting data of this device to SF4C series.
- Monitoring : Check the functional setting data saved in this device.

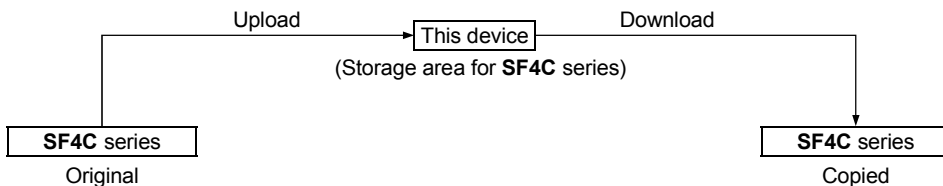

## 3-1-14 Initialization Function

The settings of SF4C series can be initialized. (factory setting) (Note)

The factory setting of each function is as follows.

Function		Setting
Fixed blanking function		Invalid
Floating blanking function		Invalid
Auxiliary output switching function		Mode 0 [Negative logic of control output (OSSD 1 / 2)]
Muting setting changing function	Muting sensor output operation setting	NONO (Normally Open, Normally Open)
	Maximum continuous valid time	No limit
	Muting function only for the sensing object exit	Invalid
	Muting input conditions	1 = 2
	Select beam channel	All beam channels
Override setting changing function	Select function	Valid
	Maximum continuous valid time	60 sec.
Muting lamp diagnosis function		Invalid
Safety input setting changing function	Select function	Valid
	Select input mode	Safety contacting point input mode
Large multi-purpose indicator setting changing function	Select mode	Mode 0 (Lights up in red when the large multi-purpose indicator input 1 is ON, Lights up in green when the large indicator input 2 is ON)
	Lockout blinking display function	Invalid
Interlock setting changing function		Mode 0 (Start / restart interlock function is valid)
External device monitor setting changing function	Select function	Valid
	Time setting	300ms
Protective function (Note1)	Password	0000
	Select function	Invalid

Notes: 1) Protective function in Ver. 2.1 of SF4C series is not initialized.

2) Setting data of copy function is not initialized.

## 3-2 Function Setting (Operation Procedure)

This section describes the setting of each function (operation procedure).

### <Selecting the setting item>

Select a setting item with FUNCTION or CANCEL switch, and confirm it with ENTER.

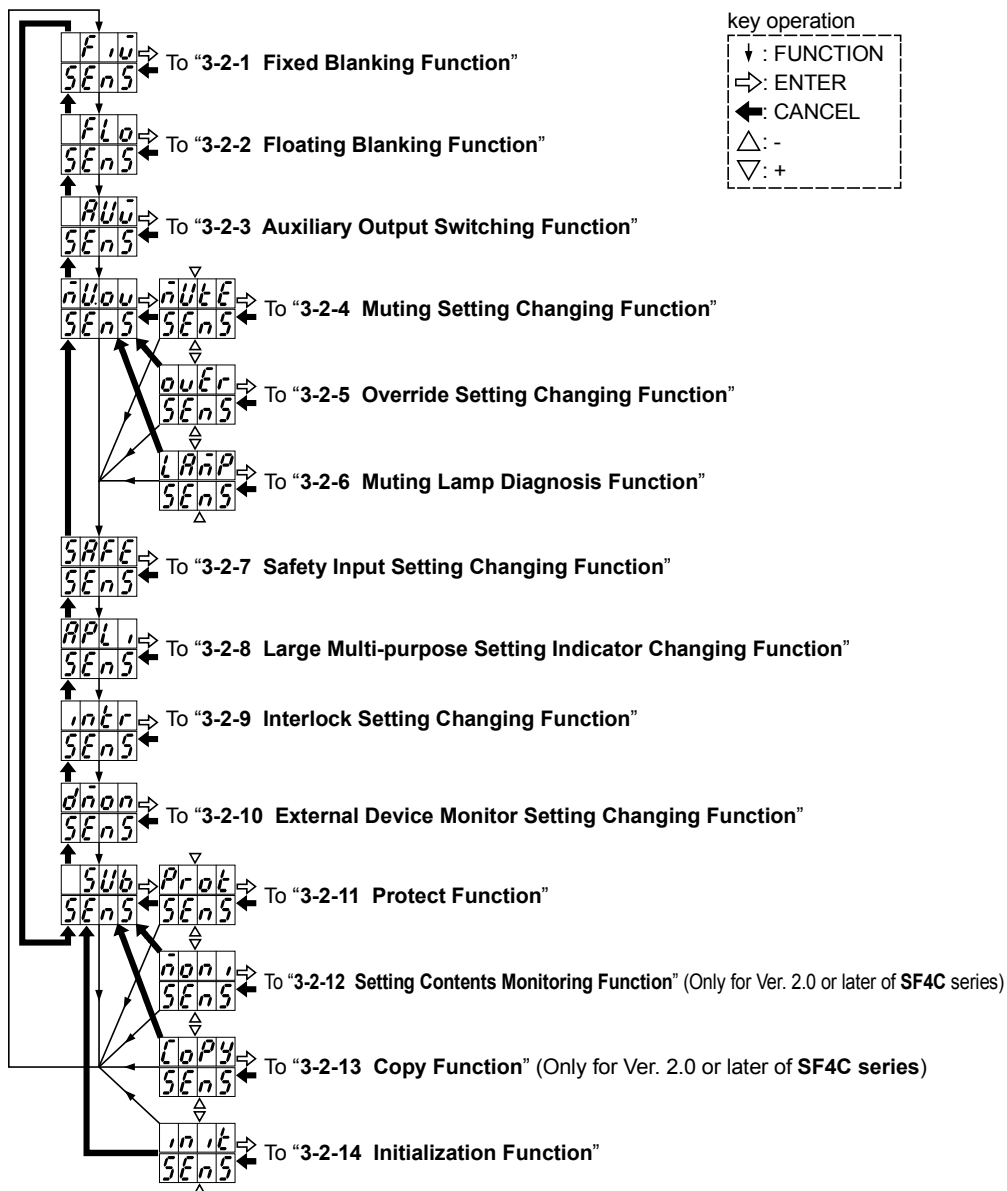

# Function Setting

## <Inputting a password>

The procedure for inputting a password is as follows.

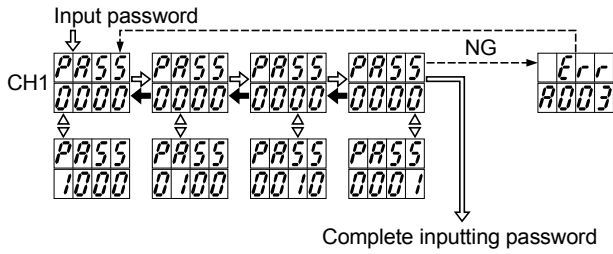

Remarks

- 1) "3-2-12 Setting Contents Monitoring Function" is not "locked."
- 2) Once the password is input, you do not need to input the password again till the power is turned OFF. (Except "3-2-11 Protective Function") However, if the power is turned ON again without changing the protective function to invalid, the password have to be input again since the protective function is still valid.

### 3-2-1 Fixed Blanking Function

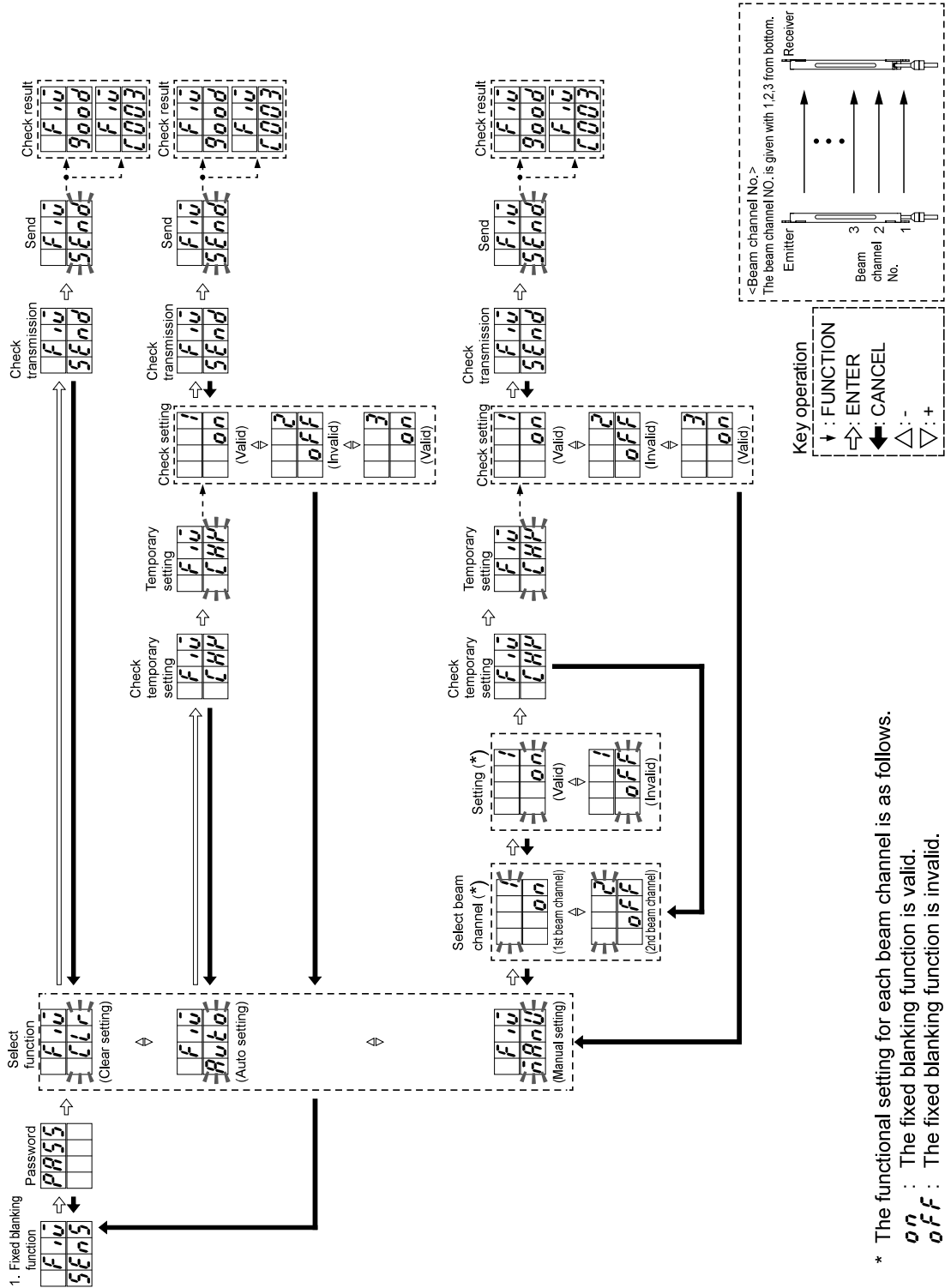

\* The functional setting for each beam channel is as follows.  
**on** : The fixed blanking function is valid.  
**off** : The fixed blanking function is invalid.

## 3-2-2 Floating Blanking Function

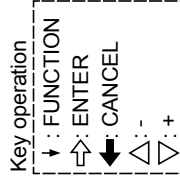
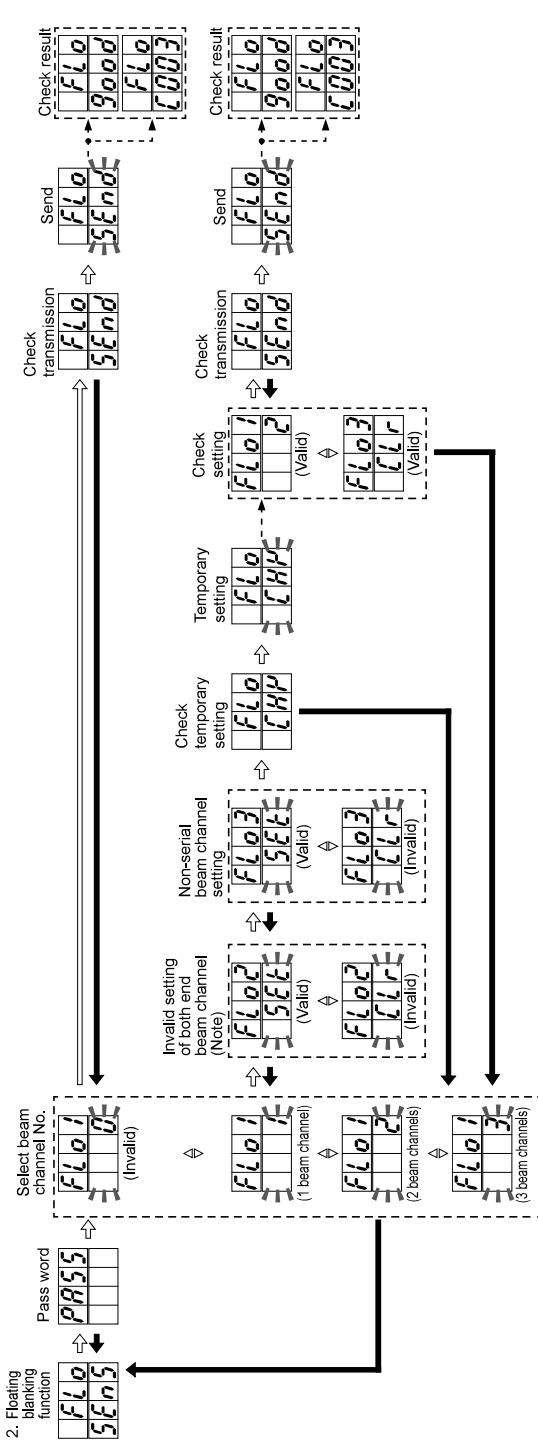

### FLO1 <Invalid setting of beam channel>

0: Invalid

1: 1 beam channel setting

2: 2 beam channels setting

3: 3 beam channels setting

### FLO2 <Invalid setting of both end beam channel> (Note)

SEt (Valid) : Both ends of the beam channels are not subject to the float blanking function

LLr (Invalid): All beam channels are subject to the floating blanking function

### FLO3 Continuos / Discontinues setting

SEt (Valid) : Non-serial beam channel mode

LLr (Invalid): Serial beam channel mode

Note: Only Ver. 2.1 of SF4C series can be set.

### 3-2-3 Auxiliary Output Switching Function

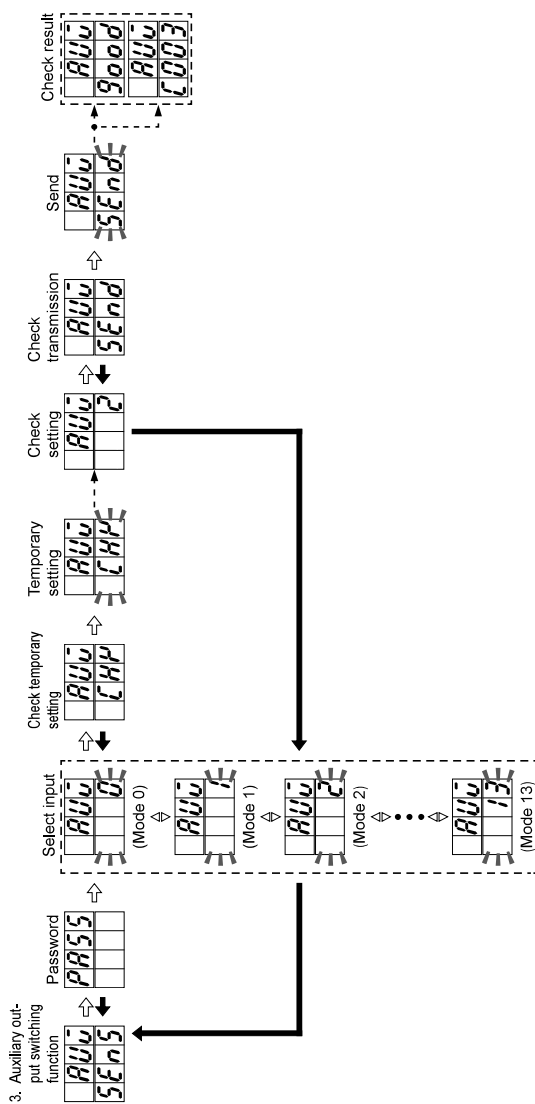

#### <Setting of the auxiliary output>

- Mode 0 : Negative logic of the control output (OSSD 1 / 2) (factory setting)
- Mode 1 : Positive logic of the control output (OSSD 1 / 2)
- Mode 2 : OFF when test input is valid
- Mode 3 : ON when test input is invalid
- Mode 4 : OFF under unstable light receiving condition (Note)
- Mode 5 : ON under unstable light receiving condition (Note)
- Mode 6 : ON during muting
- Mode 7 : OFF during muting
- Mode 8 : ON in light receiving condition
- Mode 9 : OFF in light receiving condition
- Mode 10 : ON during safety input valid
- Mode 11 : OFF during safety input valid
- Mode 12 : OFF during lockout
- Mode 13 : ON during lockout

Note: This cannot be operated when the fixed blanking function, the floating blanking function or the muting setting changing function is used.

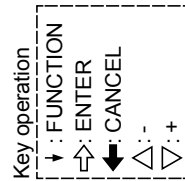

## 3-2-4 Muting Setting Changing Function

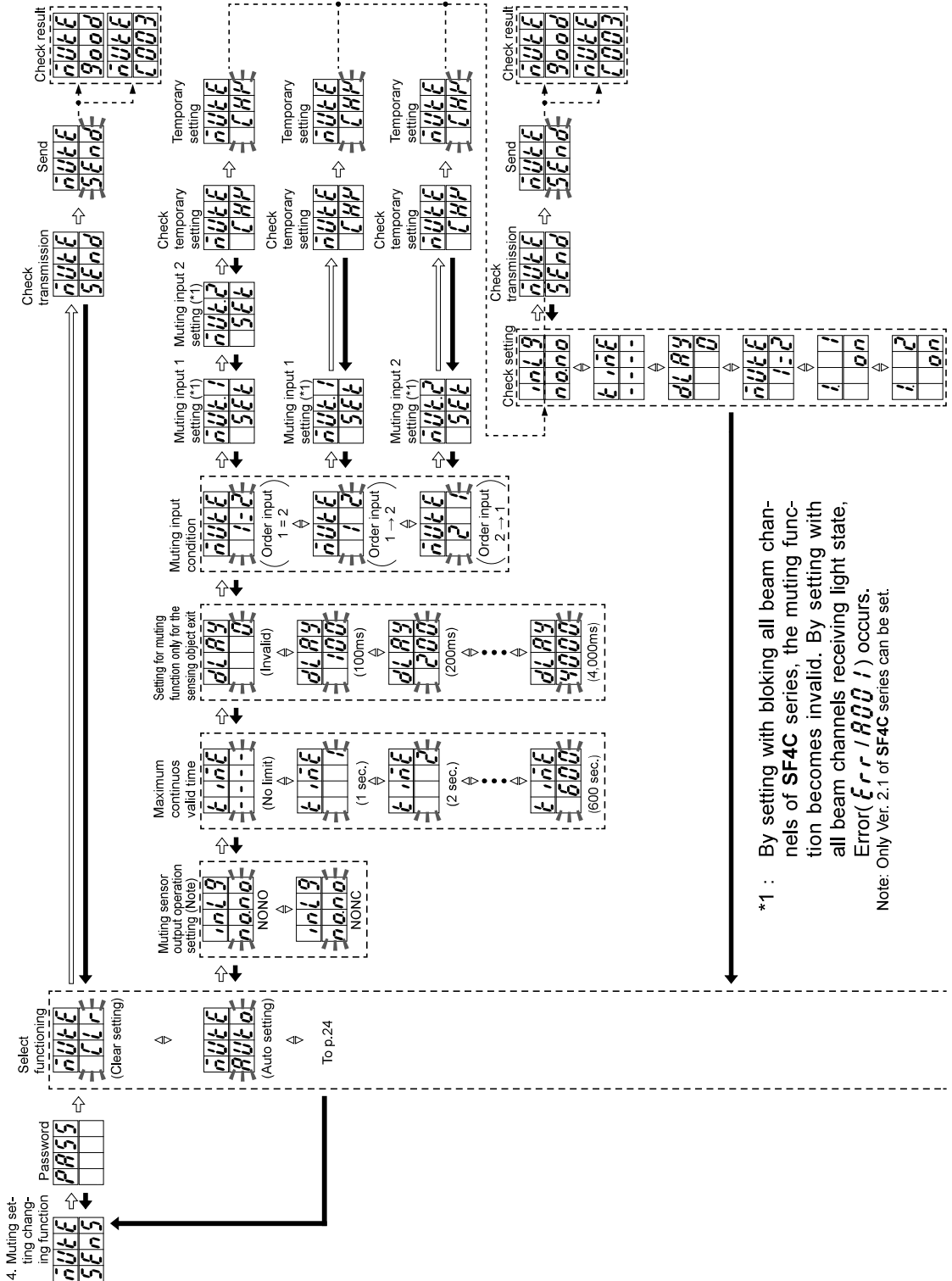

\*1 : By setting with blocking all beam channels of SF4C series, the muting function becomes invalid. By setting with all beam channels receiving light state, Error(Err1001) occurs.  
 Note: Only Ver. 2.1 of SF4C series can be set.



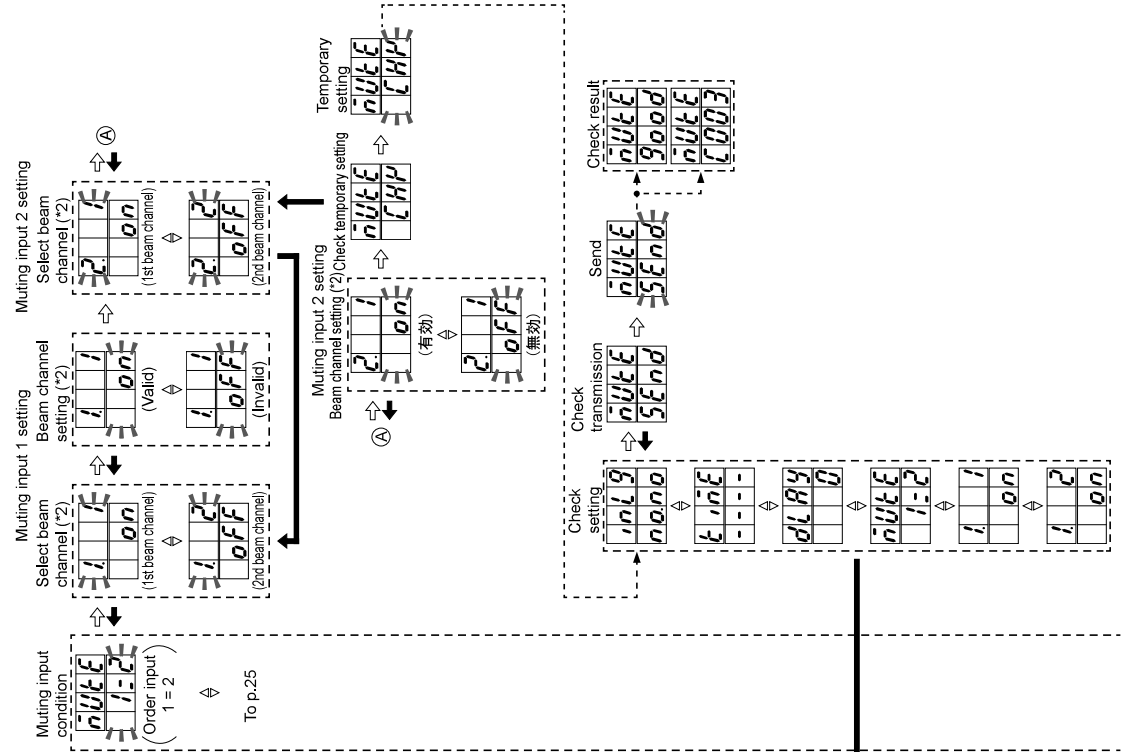

\*2 : Functional setting of each beam channel is as follows

- on : Muting function is valid
- off : Muting function is invalid

Note: Only Ver. 2.1 of SF4C series can be set.

# Function Setting

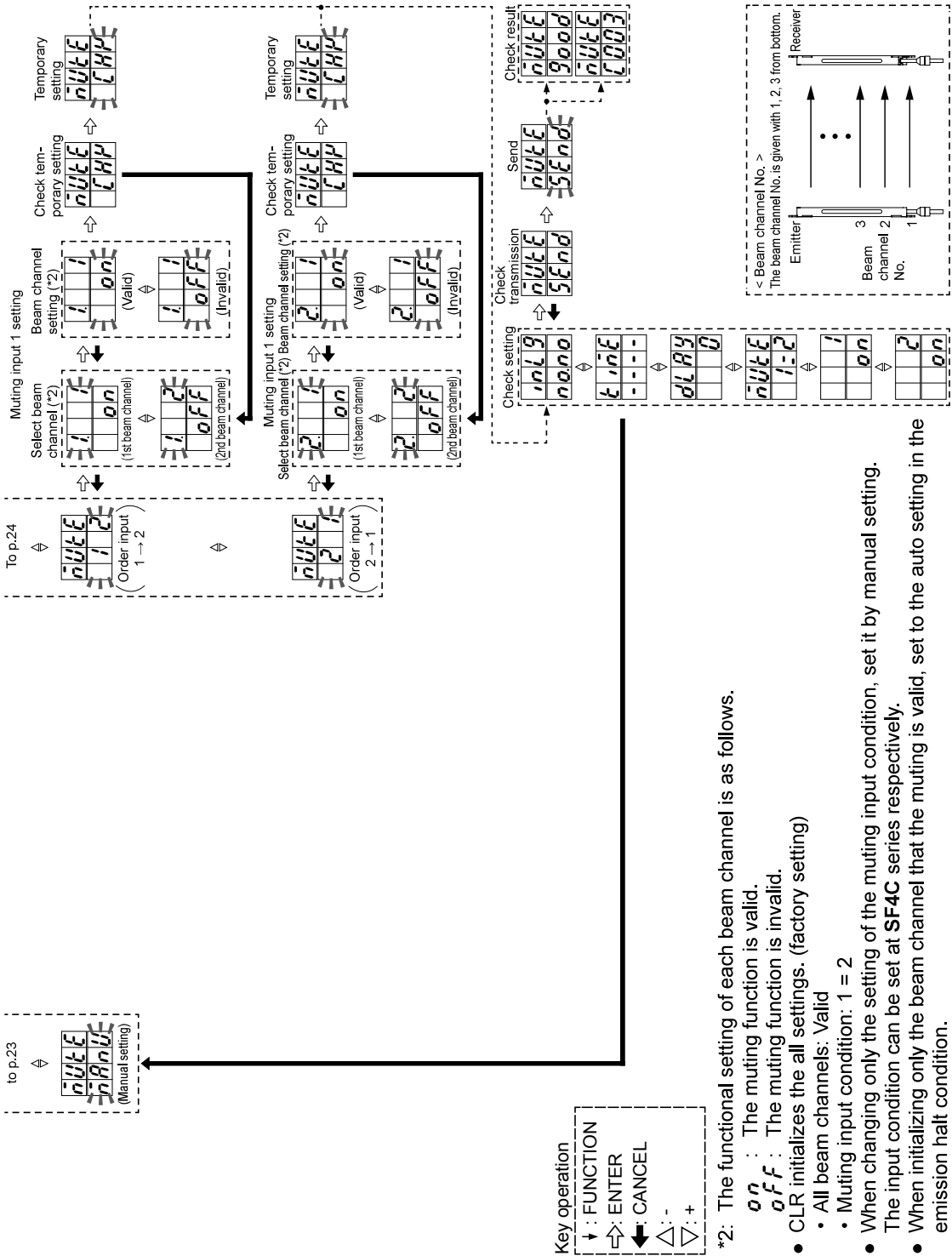

### 3-2-5 Override Setting Changing Function

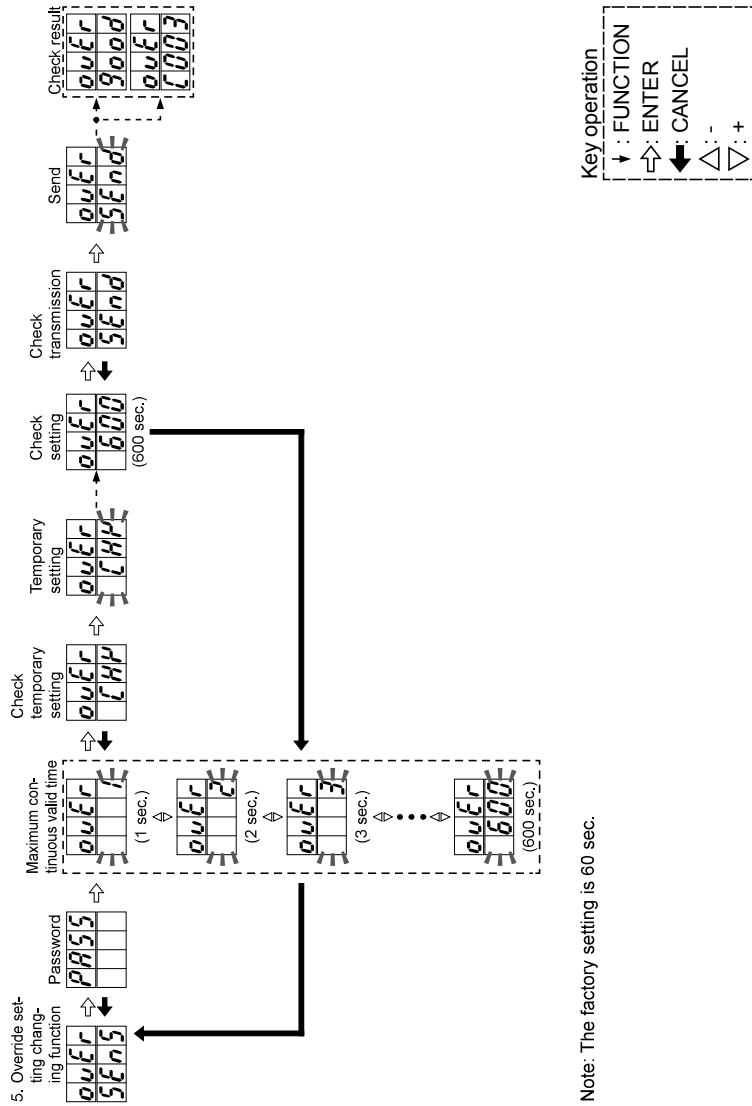

Note: The factory setting is 60 sec.

## 3-2-6 Muting Lamp Diagnosis Function

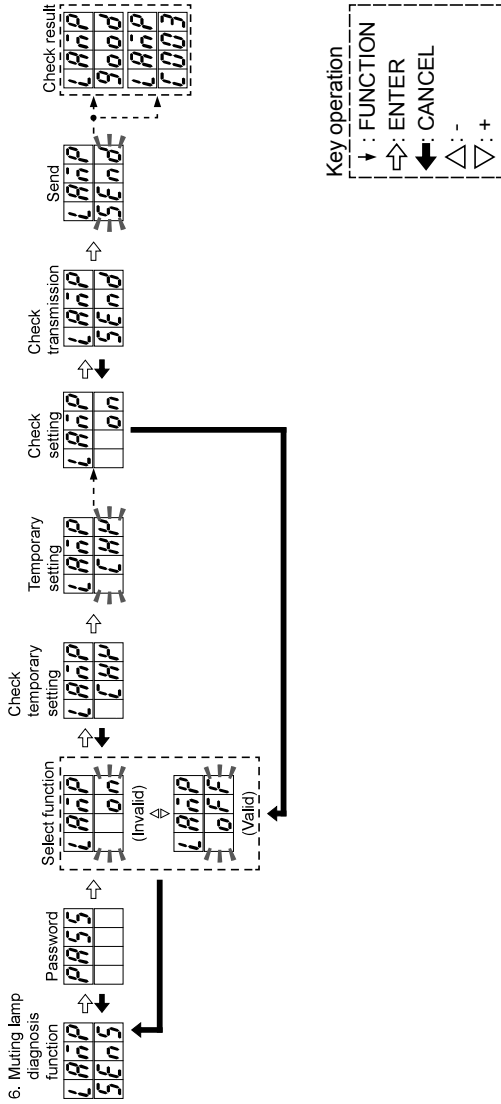

### 3-2-7 Safety Input Setting Changing Function

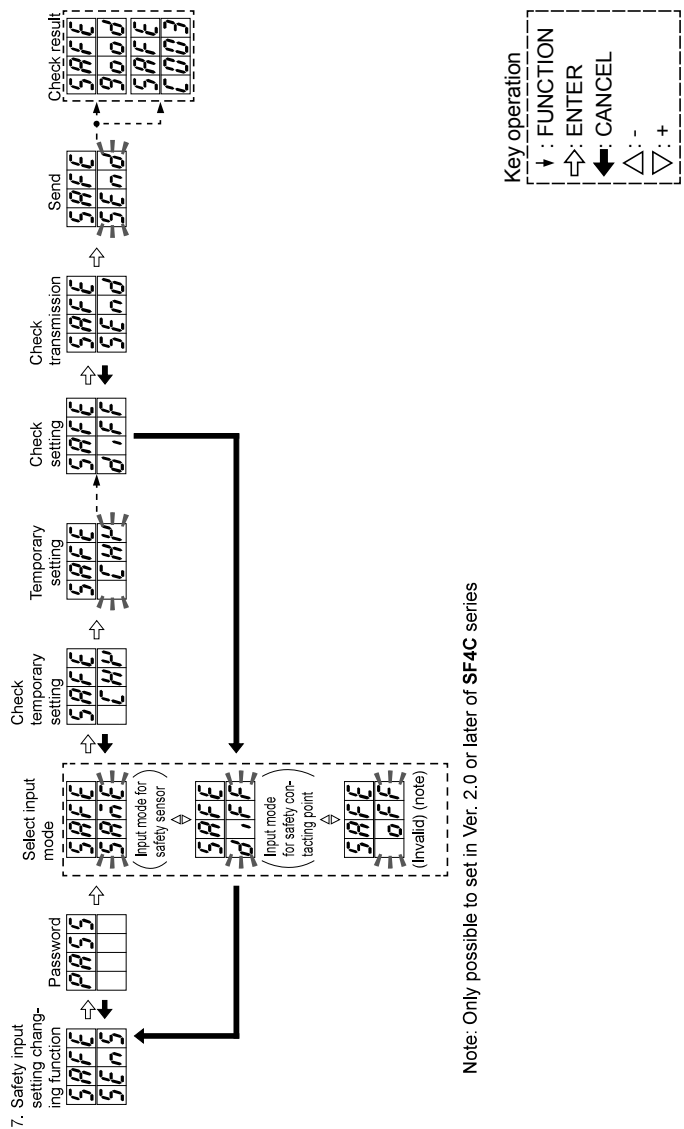

Note: Only possible to set in Ver. 2.0 or later of SF4C series

## 3-2-8 Large Multi-purpose Indicator Setting changing Function



Key operation	
↓	: FUNCTION
↵	: ENTER
←	: CANCEL
△	: -
▽	: +

### <Setting for large multi-purpose indicator>

- Mode 0 : Lights up in red during large multi-purpose indicator input 1 is ON  
Lights up in green during large multi-purpose indicator input 2 is ON  
Blinks in red during large multi-purpose indicator input 1 is ON
- Mode 1 : Blinks in red during large multi-purpose indicator input 2 is ON  
Blinks in green during large multi-purpose indicator input 2 is ON
- Mode 2 : Lights up in red during large multi-purpose indicator input 1 is ON  
Blinks in green during large multi-purpose indicator input 2 is ON
- Mode 3 : Blinks in red during large multi-purpose indicator input 1 is ON  
Lights up in green during large multi-purpose indicator input 2 is ON
- Mode 4 : Lights up in red during large multi-purpose indicator input 1 is ON  
Blinks in red during large multi-purpose indicator input 2 is ON
- Mode 5 : Blinks in green during large multi-purpose indicator input 1 is ON  
Lights up in green during large multi-purpose indicator input 2 is ON
- Mode 6 : Light up in green during control output (OSSD 1 / 2) is ON, Light up in red during control output (OSSD 1 / 2) is OFF  
Blinks in green during muting
- Mode 7 : Lights up in red during large multi-purpose indicator input 1 is ON, Blinks in red during large multi-purpose indicator input 2 is ON  
Lights up in green during muting, Blinks in green during override

### 3-2-9 Interlock Setting Changing Function

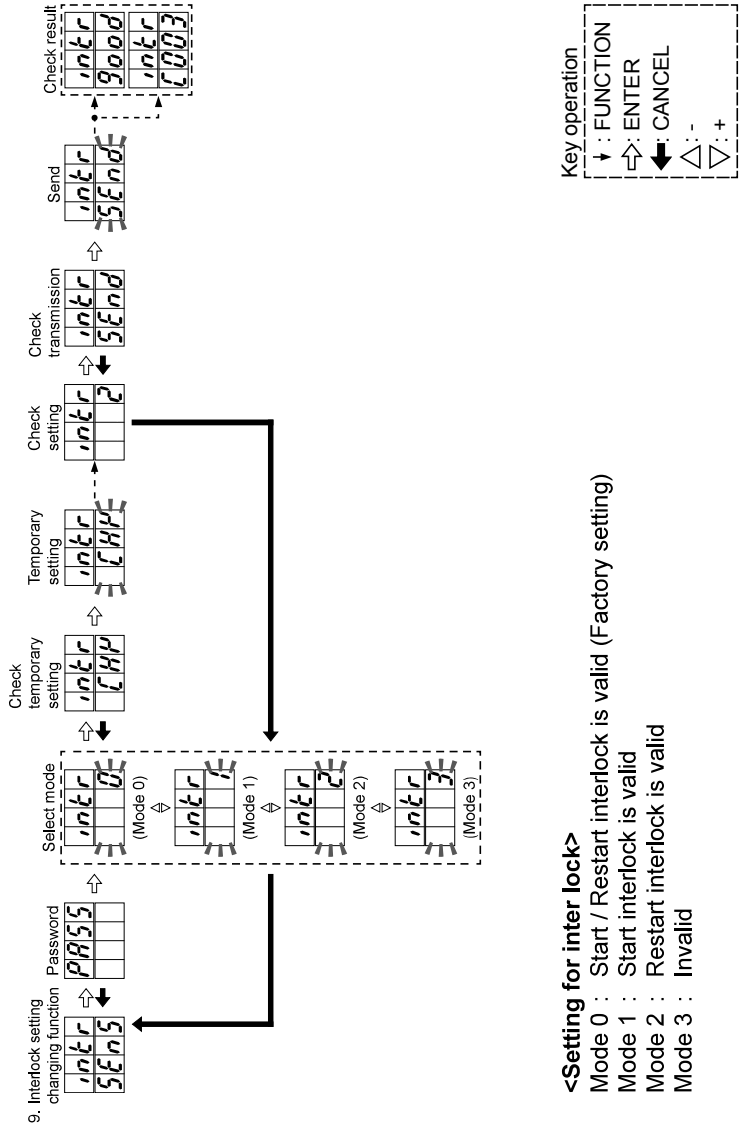

**<Setting for inter lock>**

- Mode 0 : Start / Restart interlock is valid (Factory setting)
- Mode 1 : Start interlock is valid
- Mode 2 : Restart interlock is valid
- Mode 3 : Invalid

## 3-2-10 External Device Monitor Setting Changing Function

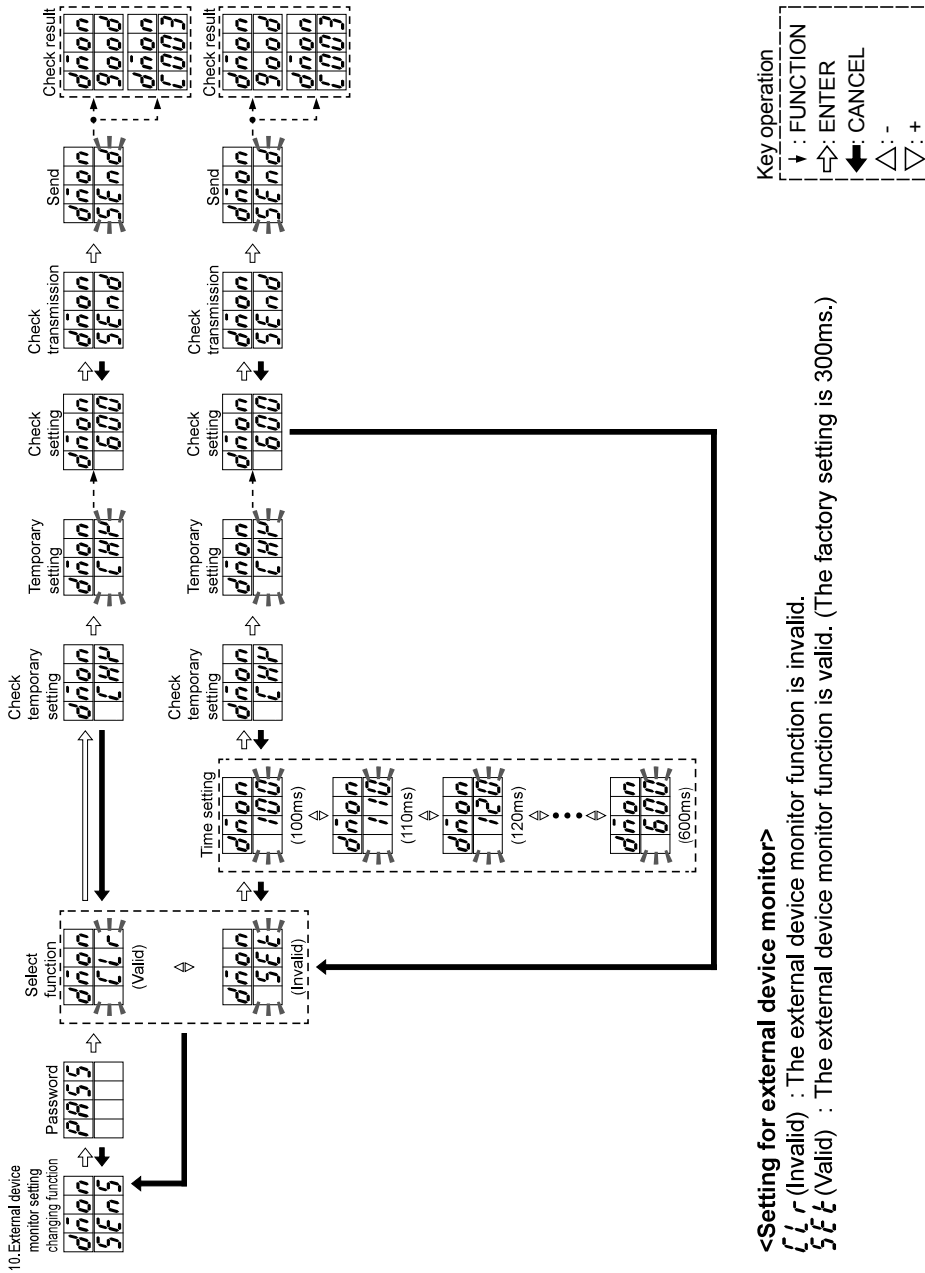

<Setting for external device monitor>

CLR (Invalid) : The external device monitor function is invalid.

SET (Valid) : The external device monitor function is valid. (The factory setting is 300ms.)



### 3-2-11 Protective Function

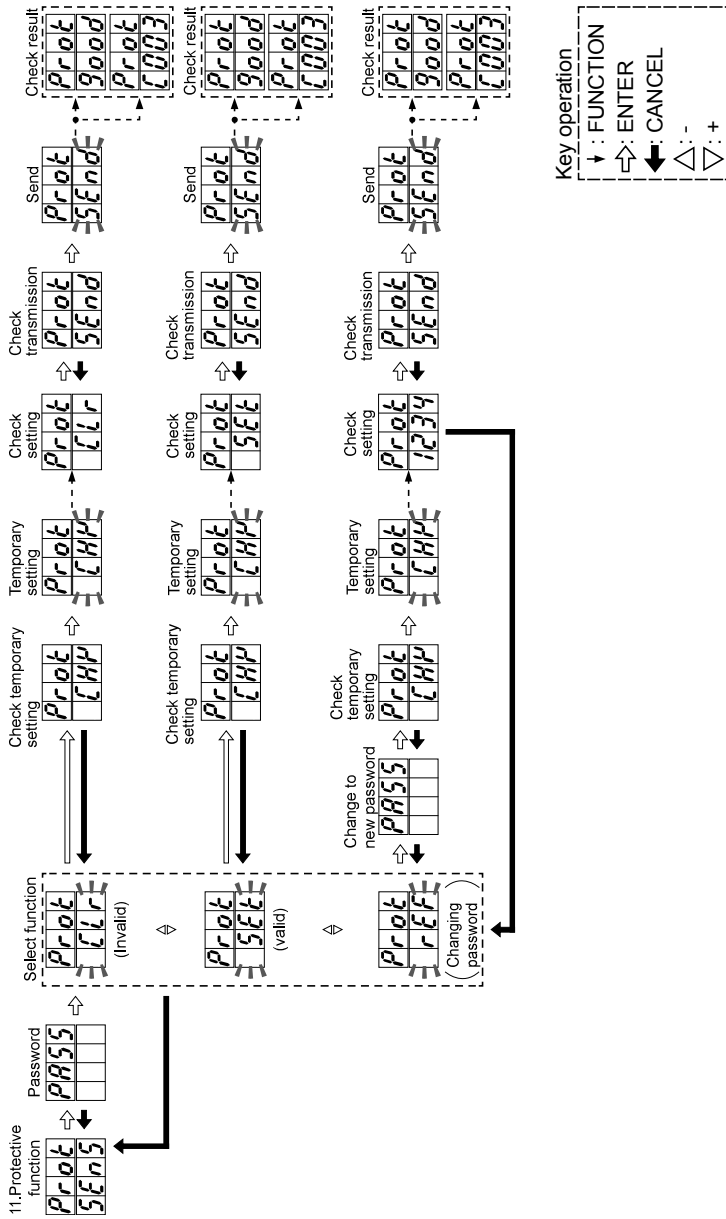

# Function Setting

## 3-2-12 Setting Contents Monitoring Function (Only for Ver. 2.0 or later of SF4C series)

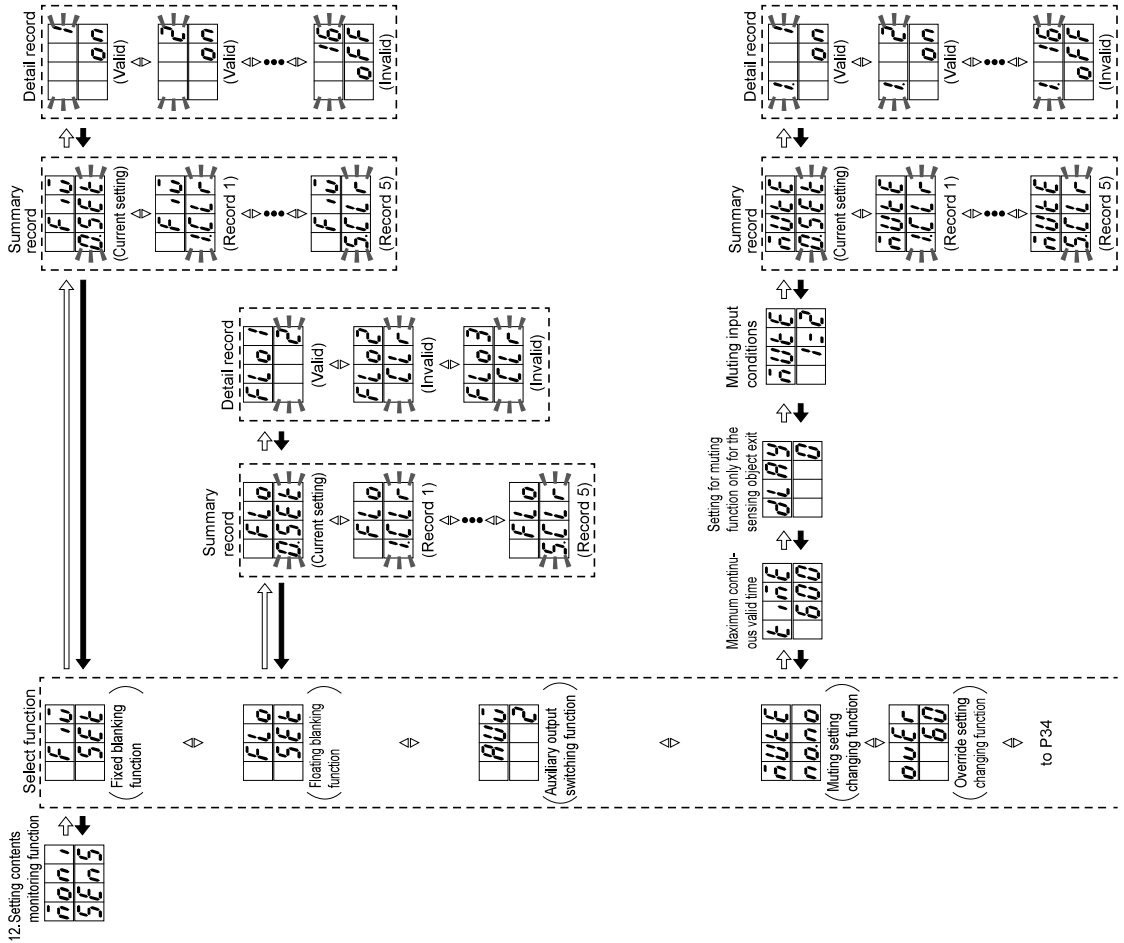

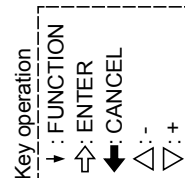
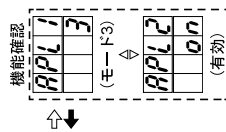
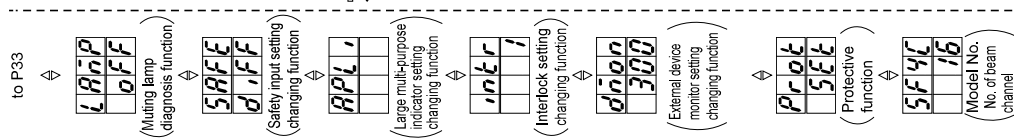

# Function Setting

## 3-2-13 Copy Function (Only for Ver. 2.0 or later of SF4C series)

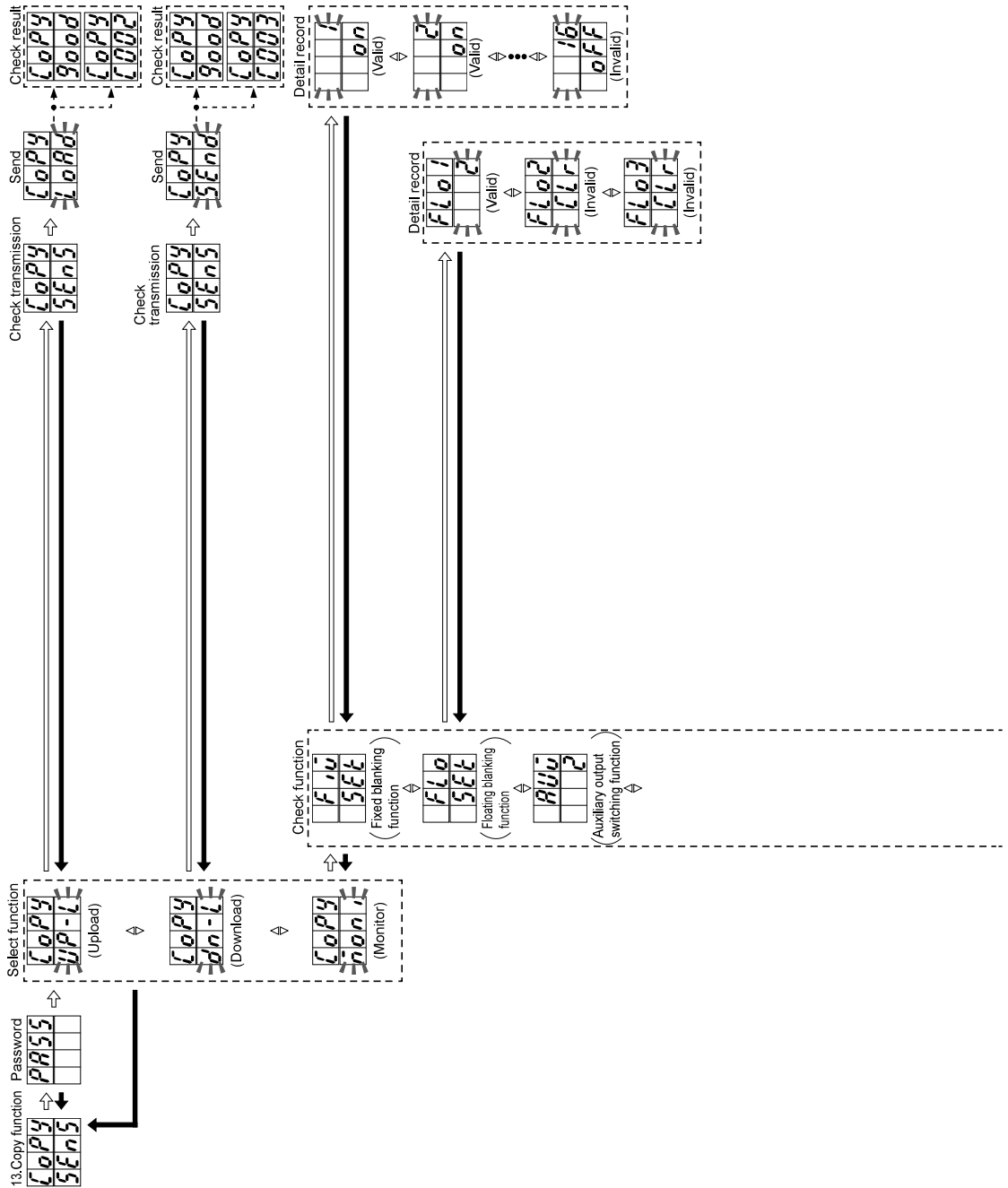

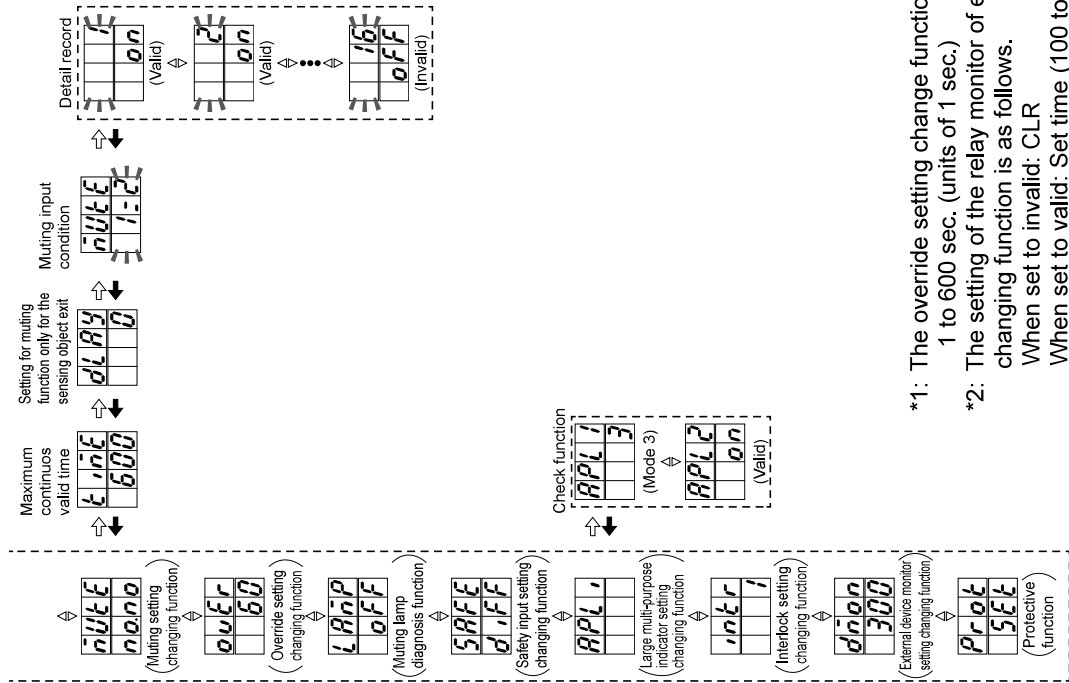

Key operation

- ↓ : FUNCTION
- ↔ : ENTER
- ← : CANCEL
- △ : -
- ▽ : +

- \*1: The override setting change function can be set in the range of 1 to 600 sec. (units of 1 sec.)
- \*2: The setting of the relay monitor of external device monitor setting changing function is as follows.  
When set to invalid: CLR  
When set to valid: Set time (100 to 600ms, in units of 10ms)

# Function Setting

## 3-2-14 Initialization Function

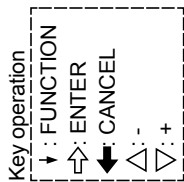
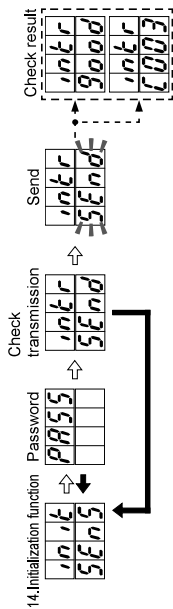









Function	Set contents
Fixed blanking function	Invalid
Floating blanking function	Invalid
Auxiliary output switching function	Mode 0 [Negative logic of control output (OSSD 1 / 2)] NONO (Normally Open, Normally Open)
Muting setting changing function	Muting sensor output operation setting Maximum continuous valid time Muting function only for the sensing object exit Muting input conditions 1 = 2 All beam channels
Override setting changing function	Select beam channel Select function Maximum continuous valid time 60 sec.
Muting lamp diagnosis function	Invalid
Safety input setting changing function	Select function Select input mode Safety contacting point input mode
Large multi purpose input function changing function	Select mode Mode 0 (Lights up in red when large multi-purpose indicator input 1 is ON, Lights up in green when large multi-purpose indicator input 2 is ON)
Interlock setting changing function	Lockout blinking display function Invalid
External device monitor setting changing function	Select function Valid Mode 0 (Start / Restart interlock function is valid)
Protective function (Note)	Time setting 300ms
	Password 0000
	Select function Invalid

Note: Protective function in Ver. 2.1 of SF4C series is not initialized.

# CHAPTER 4 TROUBLESHOOTING

Symptoms	Cause	Remedy
Control output (OSSD 1 / 2) is not turned ON.	This device is connected to the <b>SF4C</b> series.	Disconnect this device.
The settings are not changed	Turning the power OFF and ON is not done	Remove the device from <b>SF4C</b> series and Turn the power OFF and ON again.
	Disconnection, cutting down power and so on	After initialization, set again.
Lighting up fault indicator [FAULT] of <b>SF4C</b> series	EEPROM error in <b>SF4C</b> series (Data error of EEPROM)	After initialization, set again.
Light up all indicators of <b>SF4C</b> series	EEPROM error in <b>SF4C</b> series (Data error of EEPROM)	Contact our office.
Sequentially light up all indicators of <b>SF4C</b> series		
Lost a password	–	Contact our office.

Error indication	Cause	Remedy
	The fixed blanking function is set in all lights received / all lights blocked condition, or the muting function is set in all lights received condition.	Do not set the fixed blanking function in all lights received / all lights blocked condition, or the muting function in all lights received condition.
	The copy function is used for the units having different system configuration.	Use the copy function for the units having identical system configuration.
	In the copy function, download the data without uploading or select monitor of copy function.	Upload the data before downloading or select monitor of copy function.
	The password does not match.	Input the correct password. In case you forget the password, Contact our office. (Note)
	Sensor communication error 1 (Model No. is wrong)	Connect this device to <b>SF4C</b> series.
	Sensor communication error 2 (Wrong wiring between the emitter and receiver.)	Connect the emitter and receiver correctly.
	Disconnection, cutting down power and so on	After initialization, set again
	Sensor communication error 3 (Effect from noise or failure of internal circuit)	Check the noise state around the <b>SF4C</b> series.
	Failure of EEPROM in this device. (Failure on device)	Contact our office..
	Failure of EEPROM in this device. (Failure on EEPROM data)	Contact our office..

Note: The factory setting of the **SF4C** series password is "0000."

If the device does not work correctly after checking the items above, please consult us.

# CHAPTER 5 SPECIFICATIONS / DIMENSIONS

## 5-1 Specifications

Model No.	SFC-HC
Item	
Applicable model	Light curtain <b>SF4C</b> series
Supply voltage	24V DC±10% Ripple P-P 10% or less (common to sensor power supply)
Current consumption	65mA or less
Communication method	RS-485 two-way communications (specific procedure)
Digital display	4-digit red LED display × 2 (selected beam channels, setting contents etc. are displayed.)
FUNCTION indicator	Green LED × 9 (lights up when each functional setting is ON)
Functions	Fixed blanking function, Floating blanking function, Auxiliary output switching function Muting setting changing function, Override setting changing function Muting lamp diagnosis function Safety input setting changing function, Large multi-purpose indicator setting changing function Interlock setting changing function, External device monitor setting changing function, Protective function Setting contents monitoring function, Copy function (Note), Initialization function.
Protection	IP40
Ambient temperature	-10 to +55°C (No dew condensation or icing allowed), Storage: -25 to +45°C
Ambient humidity	30 to 85% RH, Storage: 30 to 85% RH
Voltage withstandability	1,000V AC for one minute between all supply terminals connected together and enclosure
Insulation resistance	20MΩ or more, with 500V DC megger between all supply terminals connected together and enclosure
Cable	8-core shielded cable with a connector on one end 0.5m long (2 pcs.)
Weight	Approx. 200g

Note: There may be a case that the copied data through the copy function is deleted due to external causes. After the copy function was used, check the copied data.

## 5-2 Dimensions

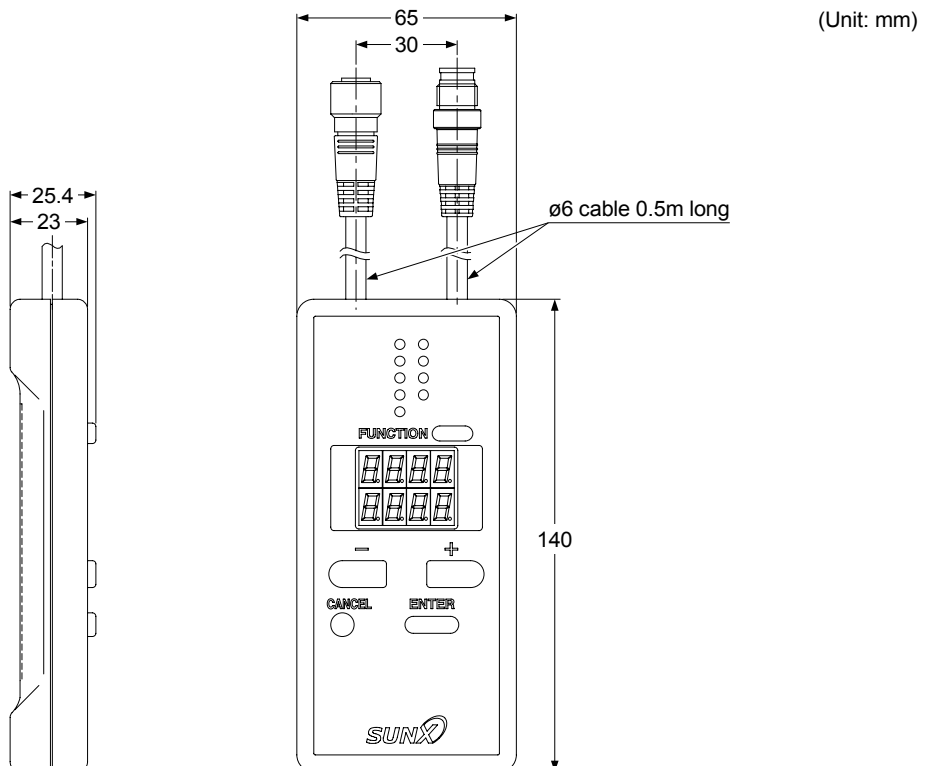



Revision history

First edition

September 10, 2009

Second edition

November 20, 2009

(MEMO)

**1. WARRANTIES:**

- (1) Subject to the exclusions stated in 2 (EXCLUSIONS) herein below, SUNX warrants the Products to be free of defects in material and workmanship for a period of one (1) year from the date of shipment under normal usage in environments commonly found in manufacturing industry.
- (2) Any Products found to be defective must be shipped to SUNX with all shipping costs paid by Purchaser or offered to SUNX for inspection and examination. Upon examination by SUNX, SUNX will, at its sole discretion, repair or replace at no charge, or refund the purchase price of, any Products found to be defective.

**2. EXCLUSIONS:**

- (1) This warranty does not apply to defects resulting from any cause:
  - (i) which was due to abuse, misuse, mishandling, improper installation, improper interfacing, or improper repair by Purchaser;
  - (ii) which was due to unauthorized modification by Purchaser, in part or in whole, whether in structure, performance or specification;
  - (iii) which was not discoverable by a person with the state-of-the-art scientific and technical knowledge at the time of manufacture;
  - (iv) which was due to an operation or use by Purchaser outside of the limits of operation or environment specified by SUNX;
  - (v) which was due to normal wear and tear;
  - (vi) which was due to Force Majeure; and
  - (vii) which was due to any use or application expressly discouraged by SUNX in 4 (CAUTIONS FOR SAFE USE) hereunder.
- (2) This warranty extends only to the first purchaser for application, and is not transferable to any person or entity which purchased from such purchaser for application.

**3. DISCLAIMERS**

- (1) SUNX's sole obligation and liability under this warranty is limited to the repair or replacement, or refund of the purchase price, of a defective Product, at SUNX's option.
- (2) THE REPAIR, REPLACEMENT, OR REFUND IS THE EXCLUSIVE REMEDY OF THE PURCHASER, AND ALL OTHER WARRANTIES, EXPRESS OR IMPLIED, INCLUDING, WITHOUT LIMITATION, THE WARRANTIES OF MERCHANTABILITY, FITNESS FOR A PARTICULAR PURPOSE, AND NON-INFRINGEMENT OF PROPRIETARY RIGHTS, ARE HEREBY EXPRESSLY DISCLAIMED. IN NO EVENT SHALL SUNX AND ITS AFFILIATED ENTITIES BE LIABLE FOR DAMAGES IN EXCESS OF THE PURCHASE PRICE OF THE PRODUCTS, OR FOR ANY INDIRECT, INCIDENTAL, SPECIAL OR CONSEQUENTIAL DAMAGES OF ANY KIND, GENERAL TERMS AND CONDITIONS 4 OR ANY DAMAGES RESULTING FROM LOSS OF USE, BUSINESS INTERRUPTION, LOSS OF INFORMATION, LOSS OR INACCURACY OF DATA, LOSS OF PROFITS, LOSS OF SAVINGS, THE COST OF PROCUREMENT OF SUBSTITUTED GOODS, SERVICES OR TECHNOLOGIES, OR FOR ANY MATTER ARISING OUT OF OR IN CONNECTION WITH THE USE OR INABILITY TO USE THE PRODUCTS.

**4. CAUTIONS FOR SAFE USE**

- (1) The applications shown in the catalogue are only suggestions, and it is Purchaser's sole responsibility to ascertain the fitness and suitability of the Products for any particular application, as well as to abide by Purchaser's applicable local laws and regulations, if any.
- (2) Never use the Products NOT rated or designated as "SAFETY SENSOR" in any application involving risk to life or property. When such a use is made by Purchaser, such Purchaser shall indemnify and hold harmless SUNX from any liability or damage whatsoever arising out of or in relation to such use.
- (3) In incorporating the Products to any equipment, facilities or systems, it is highly recommended to employ fail-safe designs, including but not limited to a redundant +++design, flame propagation prevention design, and malfunction prevention design so as not to cause any risk of bodily injury, fire accident, or social damage due to any failure of such equipment, facilities or systems.
- (4) The Products are each intended for use only in environments commonly found in manufacturing industry, and, unless expressly allowed in the catalogue, specification or otherwise, shall not be used in, or incorporated into, any equipment, facilities or systems, such as those:
  - (a) which are used for the protection of human life or body parts;
  - (b) which are used outdoors or in environments subject to any likelihood of chemical contamination or electromagnetic influence;
  - (c) which are likely to be used beyond the limits of operations or environments specified by SUNX in the catalogue or otherwise;
  - (d) which may cause risk to life or property, such as nuclear energy control equipment, transportation equipment (whether on rail or land, or in air or at sea), and medical equipment;
  - (e) which are operated continuously each day for 24 hours; and
  - (f) which otherwise require a high level of safety performance similar to that required in those equipment, facilities or systems as listed in (a) through (e) above.

**5. EXPORT CONTROL LAWS**

In some jurisdictions, the Products may be subject to local export laws and regulations. If any diversion or re-export is to be made, Purchaser is advised to abide by such local export laws and regulations, if any, at its own responsibility.

## SUNX Limited

URL : [sunx.com](http://sunx.com)

---

### Overseas Sales Division (Head Office)

2431-1 Ushiyama-cho, Kasugai-shi, Aichi, 486-0901, Japan  
Phone: +81-568-33-7861 FAX: +81-568-33-8591

---

### Europe Headquarter: Panasonic Electric Works Europe AG

Rudolf-Diesel-Ring 2, D-83607 Holzkirchen, Germany  
Phone: +49-8024-648-0

### US Headquarter: Panasonic Electric Works Corporation of America

629 Central Avenue New Providence, New Jersey 07974 USA  
Phone: +1-908-464-3550

MJE-SFCHC No.0013-09V

PRINTED IN JAPAN