

FEATURES

- Carbon resistive element
- Dust proof enclosure
- Polyester substrate
- Also upon request:
 - Wiper positioned at 50% or fully clockwise.
 - Supplied in magazines for automatic insertion.
 - Long life model for low cost control potentiometer applications
 - Self extinguishable plastic UL 94V-0
 - Cut track option
 - Special tapers
 - Mechanical detents
 - Low & extra low torque versions
 - Special switch option
 - 3% Linearity and 100K cycles mechanical life

MECHANICAL SPECIFICATIONS

- Mechanical rotation angle: $235^\circ \pm 5^\circ$
- Electrical rotation angle: $220^\circ \pm 20^\circ$
- Torque: 0.4 to 2 Ncm. (0.6 to 2.7 in-oz)
- Stop torque: > 5 Ncm. (>7 in-oz)
- Life*: Up to 10.000 cycles

* Others upon request

ELECTRICAL SPECIFICATIONS

- Range of values (*)
 $100\Omega \leq R_n \leq 5\text{ M}$ (Decad. 1.0 - 2.0 - 2.2 - 2.5 - 4.7 - 5.0)
- Tolerance (*): $100\Omega \leq R_n \leq 1\text{M}\Omega$ $\pm 20\%$
 $1\text{M}\Omega < R_n \leq 5\text{M}\Omega$ $\pm 30\%$
- Max. Voltage: 200 VDC (lin) 100 VDC (no lin)
- Nominal Power 50°C (122°F) (see power rating curve)
 0.15 W (lin) 0.07 W (no lin)
- Taper (*) (Log. & Alog. only $R_n \geq 1\text{K}$) Lin ; Log; Alog.
- Residual resistance(*): $\leq 0.5\%$ R_n (5Ω min.)
- Equivalent Noise Resistance: $\leq 3\%$ R_n (3Ω min.)
- Operating temperature**: -25°C + 70°C (-13°F + 158°F)

(*) Others upon request

** Up to 85°C depending on application

HOW TO ORDER

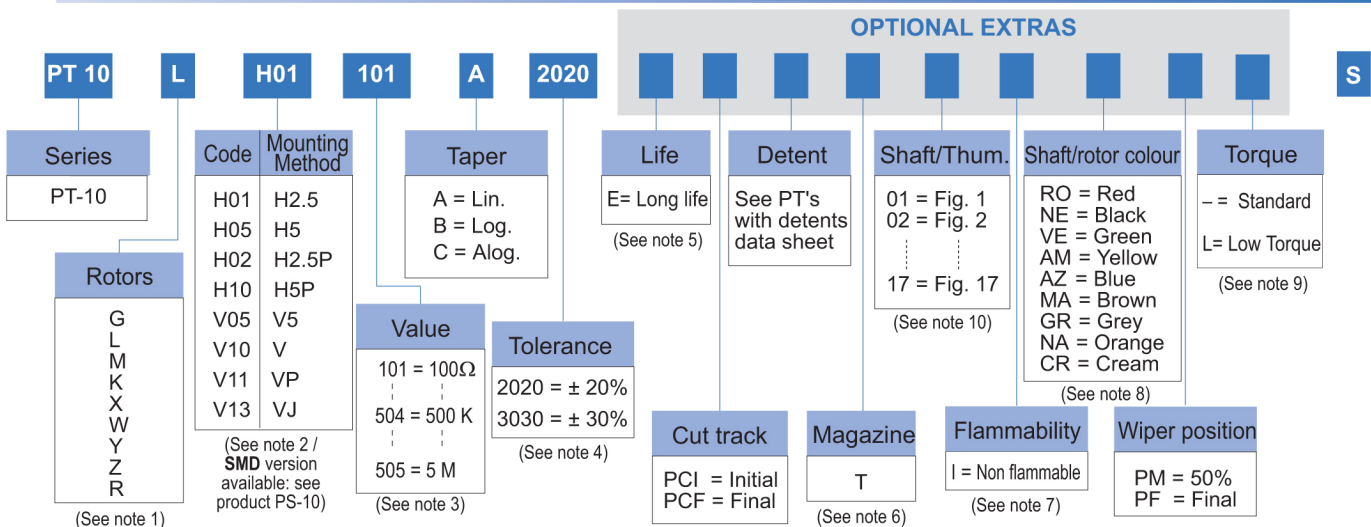

NOTES:

- "Z" adjustment only available on "H" versions. Rotor "G" only available in purple (shaft/rotor colour "VI").
- Terminals styles: "P" & "J" are crimped. V=Vertical adjust; H=Horizontal Adjust
- Value Example: Code: $\overset{10}{\text{10}} \overset{1}{\text{1}} \overset{100}{\text{00}}$
 ↳ Num of zeros
 ↳ First two digits of the value.
- Non standard tolerance, upon request. Example: $+7\%$ Code: $\overset{07}{\text{07}} \overset{05}{\text{05}}$
 ↳ negative tolerance
 ↳ positive tolerance
- Up to 10.000 cycles. Others upon request.
- Magazines: not available with the H10, V05 and V13 models, nor with adjustment types X, W, Y, Z.
- Non flammable: housing, rotor and shaft. According to UL 94V-0
- Colour shaft/rotor:
 - Potentiometer without shaft: only rotor
 - Potentiometer with shaft: only shaft
 - Cream colour only available in standard plastic.
- Low Torque: 0.25 to 1 Ncm (per pot.)
 No detent option available for low torque models.
- If you wish to use your own custom plastic shaft/knob/actuator please contact Piher for advice about compatible materials.

NOTE: The information contained here should be used for reference purposes only.

HOW TO ORDER CUSTOM DRAWING

PT-10 LH 01 + DRAWING NUMBER (Max. 16 characters)

This way of ordering should be used for options which are not included in the "How to order" standard and optional extras.

STANDARD OPTIONS

Cut track	-----	No
Detents	-----	None
Packing	-----	Bulk
Non flammable	-----	No
Rotor colour	-----	White
Shaft colour	-----	Natural
Wiper position	-----	Initial
Torque	-----	Standard

ROTORS

Without shaft

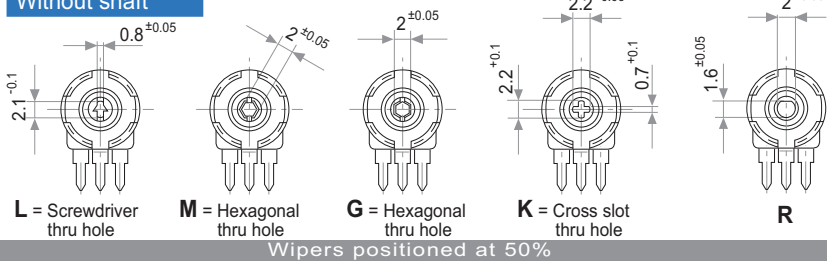

With shaft

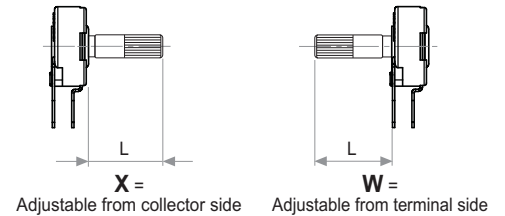

With thumbwheel

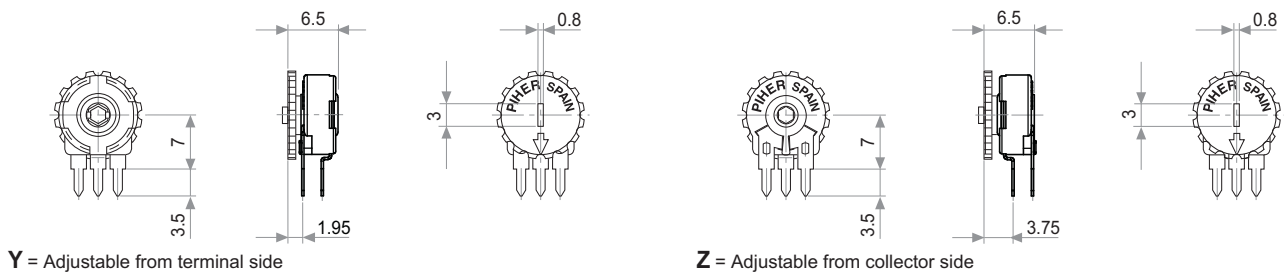

MOUNTING METHODS

v = horizontal mount – vertical adjust

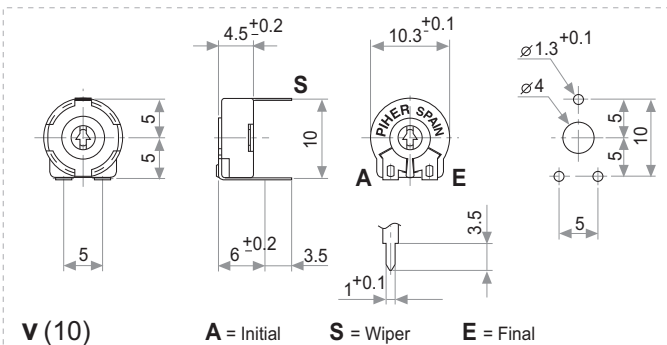

h = vertical mount – horizontal adjust

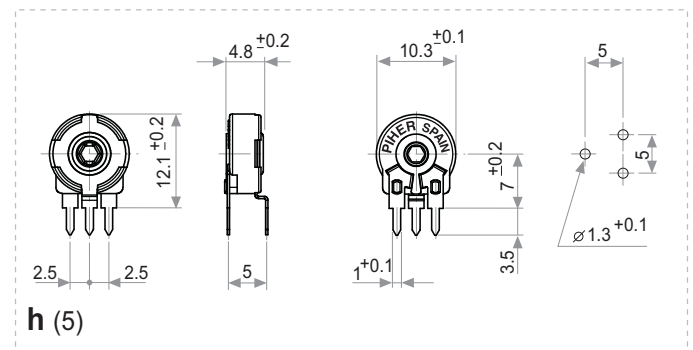
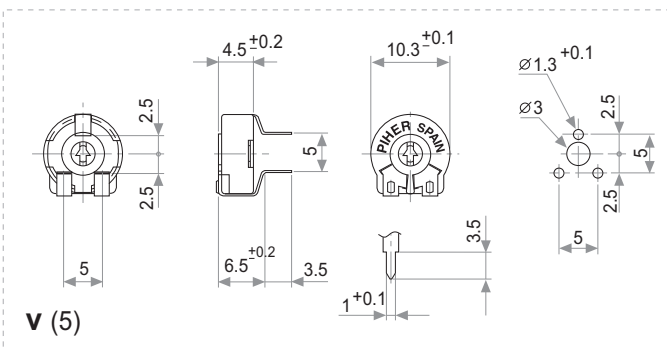
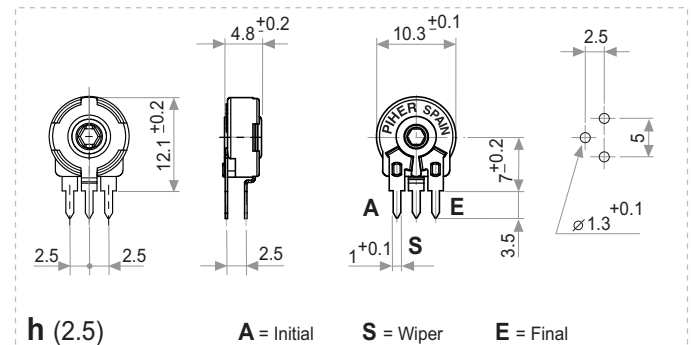

NOTE = Please note relative terminal positions when ordering non linear tapers.

Crimped terminals

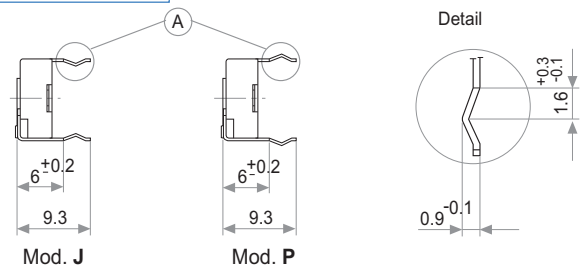

OPTIONS

Positioning (Std. Position = CCW)

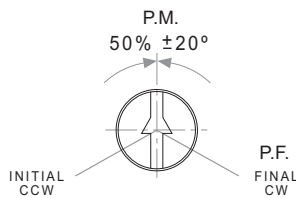

Special SWITCH (Upon request)

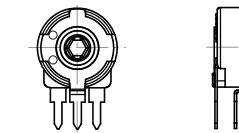

(Rotor at Final Position)

Mechanical Rotation Angle: 45°
Housing Colour: Green

CUT TRACK
CCW on-off (A)

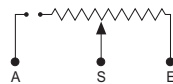
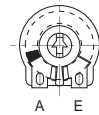

A = Initial

E = Final

S = Wiper

CW on-off (E)



TAPERS

↓ Detents combined with silver zones - click here

Standard

A = Linear
B = Log.
C = Alog.

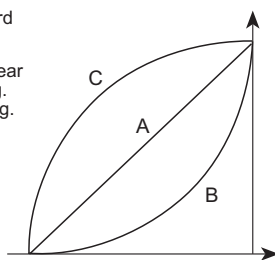

Special taper example

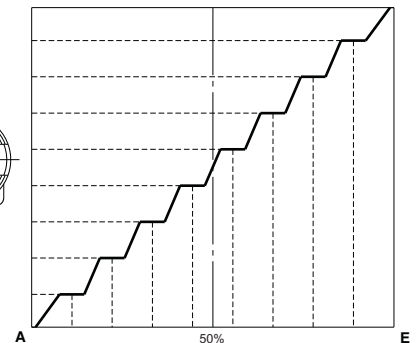
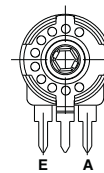
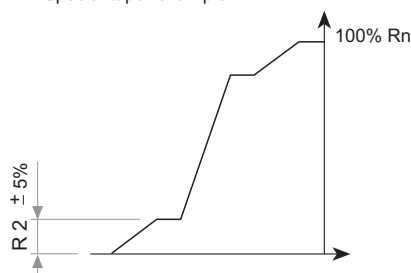

NOTE = Please note relative terminal positions when ordering non linear tapers.

TESTS

TYPICAL VARIATIONS

ELECTRICAL LIFE	1.000 h. @ 50°C; 0.15 W	±5 %
MECHANICAL LIFE (CYCLES)	500 @ 10 CPM ...15 CPM	±3 % (Rn < 1 M Ω)
TEMPERATURE COEFFICIENT	-25°C; +70°C	±300 ppm (Rn <100 K)
THERMAL CYCLING	16 h. @ 85°C; 2h. @ -25°C	±2.5 %
DAMP HEAT	500 h. @ 40°C @ 95% HR	±5 %
VIBRATION (for each plane X,Y,Z)	2 h. @ 10 Hz. ... 55 Hz.	±2 %

NOTE: Out of range values may not comply these results.

PACKAGING

BOXES

Model	Units
Without shaft	1000 (80 x 85 x 185 mm.)
With thumbwheel	800 (80 x 85 x 185 mm.)
With shaft	400 (80 x 85 x 185 mm.)

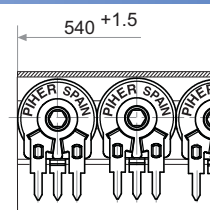
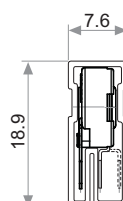

Magazines for PT-10 h 2.5; h 5

Also crimped term. h 2.5 P

AUTOMATIC INSERTION

Magazines	Units per magazine
PT-10H & PT-10V	50 Pieces

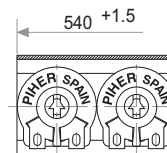
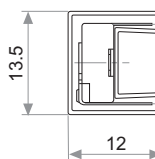

Magazines for PT-10 V

Also crimped term. VP

RECOMMENDED CONNECTION

Recommended connection scheme for Piher's position sensors (voltage divider)

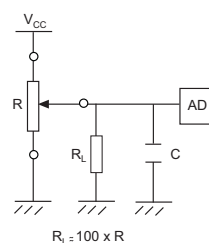

POWER RATING CURVE

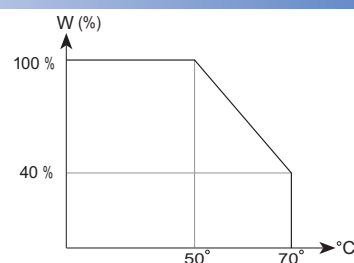

SHAFTS

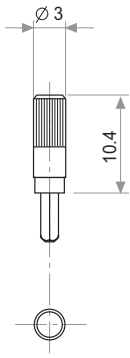

Fig. 1 / Ref. 5016

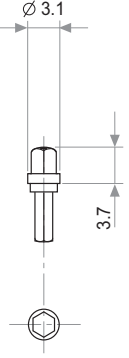

Fig. 2 / Ref. 5053

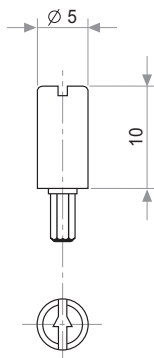

Fig. 3 / Ref. 5012

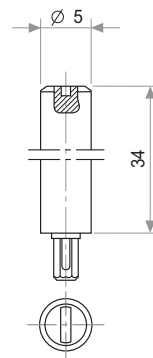

Fig. 4 / Ref. 6053

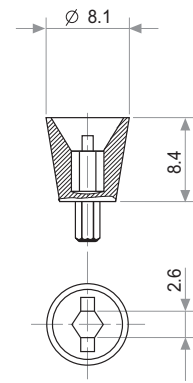

Fig. 6 / Ref. 5035

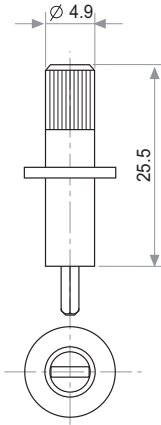

Fig. 7 / Ref. 5115

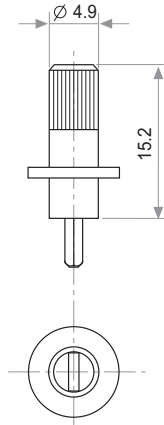

Fig. 8 / Ref. 5116

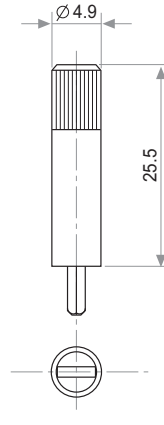

Fig. 9 / Ref. 5119

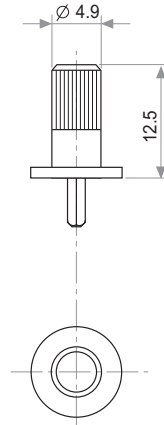

Fig. 10 / Ref. 5120

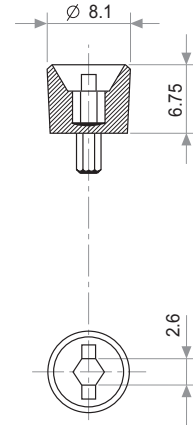

Fig. 11 / Ref. 5027

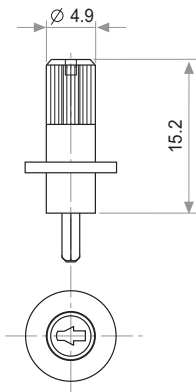

Fig. 12 / Ref. 6052

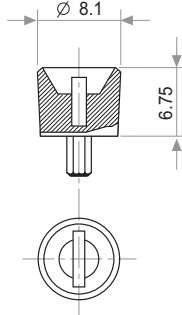

Fig. 13 / Ref. 5121

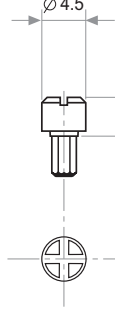
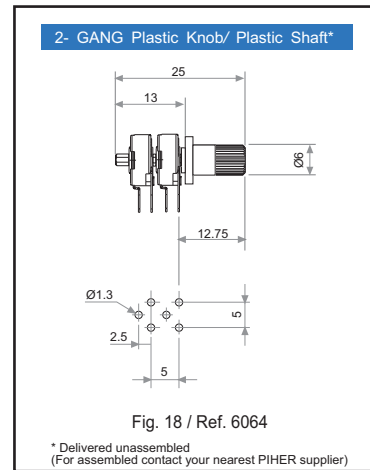

Fig. 14 / Ref. 5055



THUMBWHEELS

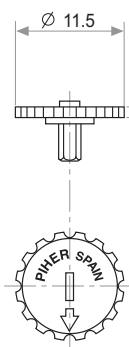

Fig. 5 / Ref. 5034

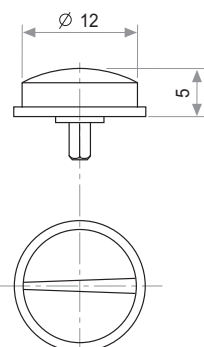

Fig. 15 / Ref. 6008

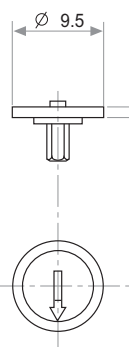

Fig. 16 / Ref. 5039

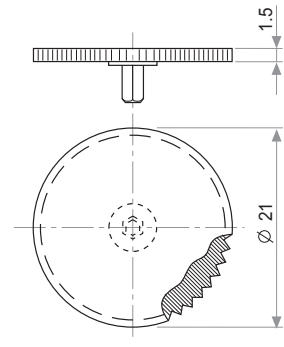

Fig. 17 / Ref. 5062

Disclaimer

The product information in this catalogue is for reference purposes. Please consult for the most up to date and accurate design information. Piher Sensors & Controls S.A., its affiliates, agents, and employees, and all persons acting on its or their behalf (collectively, "Piher"), disclaim any and all liability for any errors, inaccuracies or incompleteness contained herein or in any other disclosure relating to any product described herein. Piher disclaims any and all liability arising out of the use or application of any product described herein or of any information provided herein to the maximum extent permitted by law. The product specifications do not expand or otherwise modify Piher's terms and conditions of sale, including but not limited to the warranty expressed therein, which apply to these products.

No licence, express or implied, by estoppel or otherwise, to any intellectual property rights is granted by this document or by any conduct of Piher. The products shown herein are not designed for use in medical, life-saving, or life-sustaining applications unless otherwise expressly indicated. Customers using or selling Piher products not expressly indicated for use in such applications do so entirely at their own risk and agree to fully indemnify Piher for any damages arising or resulting from such use or sale. Please contact authorised Piher personnel to obtain written terms and conditions regarding products designed for such applications.

Product names and markings noted herein may be trademarks of their respective owners.

Information contained in and/or attached to this catalogue may be subject to export control regulations of the European Community, USA, or other countries. Each recipient of this document is responsible to ensure that usage and/or transfer of any information contained in this document complies with all relevant export control regulations. If you are in any doubt about the export control restrictions that apply to this information, please contact the sender immediately. For any Piher International Corp. Exports, Note: All products / technologies are EAR99 Classified commodities. Exports from the United States are in accordance with the Export Administration Regulations. Diversion contrary to US law is prohibited.

