



# *Test & Measurement Products Catalog*



## About RIGOL

Founded in 1998, **RIGOL** Technologies, Inc. is an ISO9001:2000 Quality Management System and ISO14001:2004 Environmental Management System Certified company, an emerging T&M leader and a technology innovator in Electronic Measurement and Chemical Analysis. **RIGOL**'s premium line of products includes Digital Oscilloscopes, RF Spectrum Analyzers, Digital Multimeters, Function/Arbitrary Waveform Generators, Digital Programmable Power Supplies, HPLC and UV-Vis Spectrophotometers, which help the engineers, researchers, educators to address their measurement challenges in confidence with affordability than ever before.

**RIGOL** Headquartered in Beijing, China, with the branch offices in Cleveland, OH, and Munich, Germany, the company's 400 employees and more than 150 distributors or representatives offer products and services in over 60 countries/regions on six continents. More information about **RIGOL** is available at [www.rigol.com](http://www.rigol.com).

## RIGOL Milestones

July, 1998	RIGOL was founded in Beijing.
May, 1999	RIGOL's first product RVO2100, a high performance Virtual Digital Storage Oscilloscope was introduced.
Mar, 2002	DS3000 series, the RIGOL's first high performance Bench-Top DSO was introduced.
Feb, 2004	DS5000 series, the China's first 1GSa/s real-time sample rate, up to 200MHz bandwidth DSO was introduced.
Apr, 2006	RIGOL received ISO9001:2000 Quality Management System Certification.
Apr, 2006	RIGOL DS1000CD series oscilloscope was introduced, the best Performance/Price Mixed Signal Oscilloscope (MSO) in the world.
July, 2006	DG3000 and DG2000 series Function/Arbitrary Waveform Generator were introduced. The first Mixed Signal Generator (MSG) in the world with 1 analog channel and optional 16 digital channels.
Aug, 2006	DM3000 series, RIGOL's 6½ digits Digital Multimeter was introduced.
Apr, 2007	RIGOL jointly drafted the China National Standard GB/T 15289-07: "General Specification and Test Method for Digital Storage Oscilloscopes."
Apr, 2007	RIGOL received ISO14001:2000 Environmental Management System Certification.
May, 2007	DS1000A series, the China's first 2GSa/s real-time sampling rate, up to 300MHz bandwidth DSO was introduced.
May, 2007	DG1000 series Function/Arbitrary Waveform Generator with build-in counter was introduced.
Oct, 2007	RIGOL opened R&D center in Shanghai to strengthen its research and development capability.
Apr, 2008	DS1000B series Digital Oscilloscope, the China's first DSO with 4-channels and LXI standard compliance was introduced.
Nov, 2008	RIGOL was certified as Municipal Technology Center of Beijing.
Apr, 2009	High-performance 80W, 3-output programmable linear DC power supply DP1308A was introduced.
Aug, 2009	DSA1000A series Spectrum Analyzer with the digital IF technology was introduced.
Nov, 2009	DS6000 series digital oscilloscope, the first DSO in China featuring 1GHz Bandwidth, 5GSa/s real time sample rate, 140Mpts Memory Depth and 180,000 wfm/s capture rate was introduced.
Feb, 2010	DP1116A with up to 160W, single-output Programmable linear DC Power Supply was introduced.
July, 2010	DG5000 series signal station, the world's first Arbitrary/Function Generator with I/Q modulation function in its class was introduced.
Oct, 2010	High precision 6½ digits DM3068 was introduced.
June, 2011	DS6104 Digital Oscilloscope won the 2011 R&D100 Awards in USA.
Aug, 2011	DG4000 Series Function/Arbitrary Waveform Generator was introduced.
Sept, 2011	DS4000 Series Digital Oscilloscope was introduced.
Oct, 2011	DSA800 Series Spectrum Analyzer was introduced.
Feb, 2012	DS2000 Series Digital Oscilloscope was introduced, the world's first uV/div level vertical sensitivity oscilloscope.
June, 2012	DG4000 Series Function/Arbitrary Waveform Generator won the 2012 R&D100 Awards in USA.
Oct, 2012	DP800 Series 1/2/3 channel Programmable linear DC Power supply was introduced.
Sep, 2013	DS1000Z Series 4 Channels Digital Oscilloscope with UltraVision Technology plus built in 2 channels 25MHz waveform generator was introduced.
Sep, 2013	MSO4000 Series 4+16 Channels Mixed Signal Oscilloscope with UltraVision Technology was introduced.
Sep, 2013	DG1000Z Series Dual channel Function/Arbitrary Waveform Generator with SiFi Technology was introduced.
Sep, 2013	DSG3000 Series up to 6GHz RF Source with IQ Modulation Technology was introduced.
Sep, 2013	M300 Series Modular Data Acquisition/Switch system with 10 kinds of modules was introduced.
Sep, 2013	DS2000A Series 2 Channels Digital Oscilloscope with UltraVision Technology plus built in 2 channels 25MHz waveform generator was introduced.

## Contents

Company Profile & History .....	Page 2
▶ Digital Oscilloscope .....	4 -19
DS6000 Series Digital Oscilloscope .....	Page 4
MSO/DS4000 Series Digital Oscilloscope .....	Page 7
DS2000A Series Digital Oscilloscope .....	Page 11
DS1000Z Series Digital Oscilloscope .....	Page 14
DS1000B Series Digital Oscilloscope .....	Page 17
DS1000 Series Digital Oscilloscope .....	Page 18
Digital Oscilloscope Probes .....	Page 19
▶ Spectrum Analyzer .....	20-26
DSA1000 Series Spectrum Analyzer .....	Page 20
DSA800 Series Spectrum Analyzer .....	Page 24
▶ RF Source .....	27-31
DSG3000 Series RF Source .....	Page 27
▶ Function/Arbitrary Waveform Generator .....	32-38
DG5000 Series Function/Arbitrary Waveform Generator .....	Page 32
DG4000 Series Function/Arbitrary Waveform Generator .....	Page 34
DG1000Z Series Function/Arbitrary Waveform Generator .....	Page 36
DG1000 Series Function/Arbitrary Waveform Generator .....	Page 38
▶ Digital Multimeter .....	39-43
DM3068 6½ Digital Multimeter .....	Page 39
DM3058/DM3058E 5½ Digital Multimeter .....	Page 42
▶ Data Acquisition/Switch system .....	44-47
M300 Series Data Acquisition/Switch system .....	Page 44
▶ Programmable DC Power supply .....	48-51
DP1000 Series Programmable DC Power supply .....	Page 48
DP800 Series Programmable DC Power supply .....	Page 50
▶ RIGOL Instrument PC Software .....	52-55

# DS6000 Series Digital Oscilloscope



## ► Features and Benefits

- Bandwidth 1GHz, 600 MHz
- Sample Rate Up to 5 GSa/s
- Channels 2 or 4
- Memory 140 Mpts(Std.)
- Waveform capture rate Up to 180,000 waveforms per second
- Real Time Waveform Record, Replay & Analysis(Std. up to 200,000 frames)
- Innovative "UltraVision" technology
- A variety of Trigger functions and Automatic measurements with statistics
- Support serial bus trigger(Std.) and decoding(Opt.)
- Dedicated data search knob" WaveFinder "
- Battery Option (China Only)
- Complete connectivity: USB Host& Device, LAN(LXI), AUX, VGA, USB-GPIB(Opt.)
- Built-in 1 GBytes Flash Memory
- 10.1 inch WVGA(800X480) Display

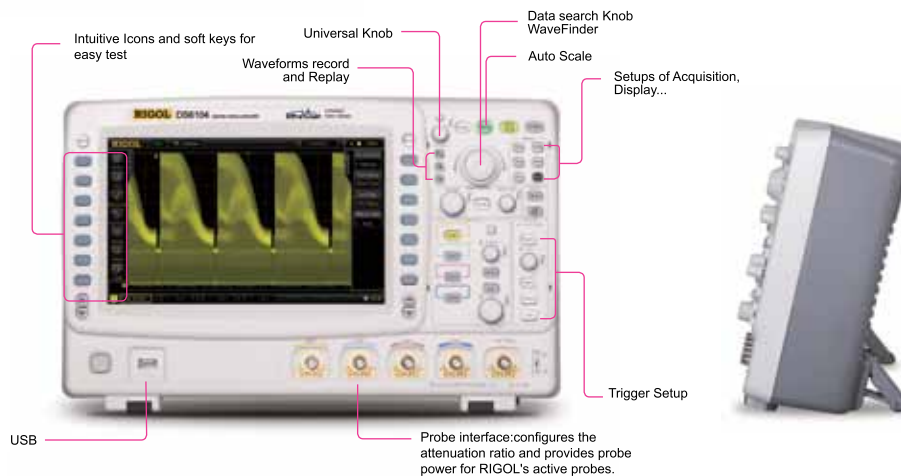

Product Dimensions : Width × Height × Depth=399mm × 255.3mm × 123.8mm Weight:5.35 kg

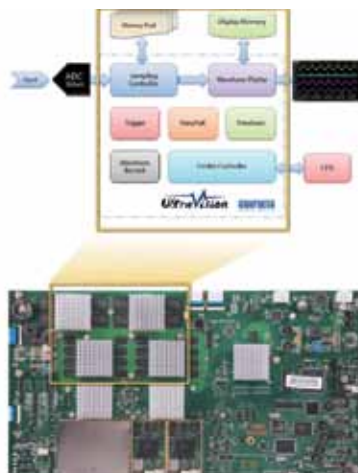

## UltraVision

- Deeper Memory Depth(Std. 140Mpts)
- Higher Waveform capture rate (Up to 180,000 wfms/s)
- Real Time waveform Record,Replay & Analysis (Up to 200,000 frames)
- Multi-level intensity grading display



## ► Features and Benefits

UltraVision: Up to 180K Waveforms/s Waveform capture rate

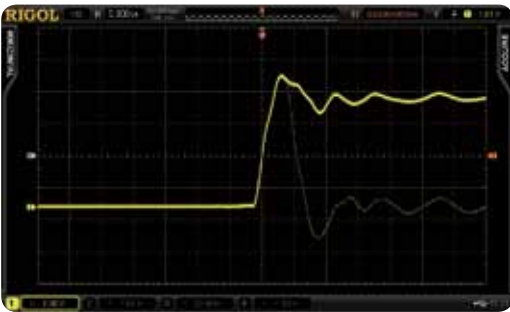

UltraVision: Real time waveform Record,Replay & Analysis



UltraVision: Multi-Level intensity grading display

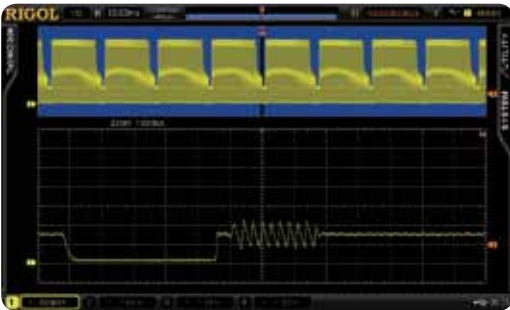

Advanced math function



Standard Mask test function



Auto measurements with statistics(Measure up to 5 parameters simultaneously)

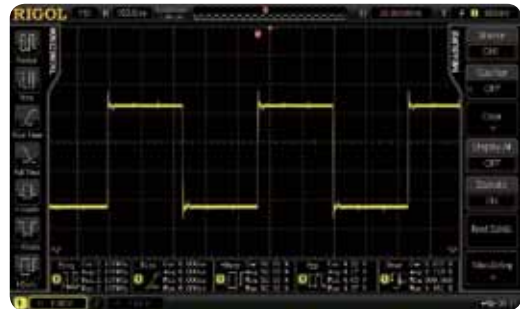

Standard Serial Bus trigger functions (RS232,I2C,SPI,CAN etc.)



Optional Serial bus decoding function with listing display



## ► Key Specifications

Model Number	DS6104	DS6102	DS6064	DS6062
Analog BW	1 GHz		600 MHz	
Channels	4	2	4	2
Max. Sample rate	5 GSa/s			
Max. Memory Depth	140 Mpts (Std.)			
Max. Waveform Capture rate	180,000 wfms/s			
Time Base Accuracy	≤ ±4 ppm			
Time Base Drift	≤ ±2 ppm/Year			
Timebase Scale	DS606X:1 ns/div to 1000 s/div DS610X:500 ps/div to 1000 s/div			
Input Impedance	1MΩ, 50 Ω			
Vertical Scale	2 mV/div to 5 V/div(1 MΩ) 2 mV/div to 1 V/div(50 Ω)			
DC Gain Accuracy	±2% full scale			
Bandwidth Limit	20 MHz or 250 MHz			
Real Time waveform Record, Replay and Analysis function	Max. 200,000 frames(Std.)			
Std. trigger functions	Edge, Pulse width, Slope, Video, HDTV, Pattern, RS232/UART, I2C, SPI, CAN, USB, FlexRay			
Serial Bus decoding	RS232/UART, I2C, SPI, CAN, FlexRay			
Math functions	A+B, A-B, A×B, A/B, FFT, Advanced Math, Logic operation			
Auto Measurements	Vpp, Vamp, Vmax, Vmin, Vtop, Vbase, Vavg, Vrms, Overshoot, Preshoot, Area, Period Area, Freq, Period, Rise Time, Fall Time, +Width, -Width, +Duty, -Duty, Delay A→B rising edge, Delay A→B falling edge, Phase A→B rising edge, Phase A→B falling edge			
Connectivities	Dual USB HOST, USB DEVICE, LAN, VGA, 10MHz Input/Output, Aux Output(TrigOut, Quick Edge, PassFail, Calibration, GND)			
Display	10.1 inches (257 mm) TFT LCD display, 800 Horizontal × RGB × 480 Vertical Pixel, Multiple intensity grading			
Size (W×H×D)	399.0 mm × 255.3 mm × 123.8 mm			
Weight	5.345 ± 0.2 kg (Without Package)			
Std. Probes	600MHz BW Passive Probe: 4 sets for 4 channel models, 2 sets for 2 channel models 1.5GHz BW Passive Probe: 2 sets for DS6104, 1 set for DS6102			

## ► Ordering Information

Model	Description	Order Number
	DS6104 (1 GHz, 4-channel)	DS6104
	DS6102 (1 GHz, dual-channel)	DS6102
	DS6064 (600 MHz, 4-channel)	DS6064
	DS6062 (600 MHz, dual-channel)	DS6062
Standard Accessories	Power Cord conforming to the standard of the country	-
	Front Panel Cover	FPCS-DS6000
	USB Data Cable	CB-USBA-USBB-FF-150
	600MHz BW Passive Probe, 4 sets for 4 channel models, 2 sets for 2 channel models	RP5600A
	1.5GHz BW Passive Probe, 2 sets for DS6104, 1 set for DS6102	RP6150A
	Quick Guide	-
	Resource CD (User's Guide and Application Software)	-
Optional Accessories	1.5GHz Active Differential Probe	RP7150
	500MHz BW Passive Probes(Support all models)	RP3500A
	600MHz BW Passive Probe(Support all models)	RP5600A
	1.5GHz BW Passive Probe(Support all models)	RP6150A
	11.1 V, 147 Wh Lithium Battery Set	BAT (China Only)
	USB to GPIB Module	USB-GPIB
	Desk Mount Instrument Arm	ARM
	Rack Mount Kit	RM-DS6000
Decoding Options	RS232/UART Decoding kit	SD-RS232-DS6000
	I2C/SPI Decoding kit	SD-I2C/SPI-DS6000
	CAN Decoding kit	SD-CAN-DS6000
	FlexRay Decoding Kit	SD-FlexRay-DS6000

# DS4000 Series Digital Oscilloscope



## ► Features and Benefits

- Bandwidth 500MHz, 350MHz, 200MHz, 100MHz
- Sample Rate Up to 4GSa/s
- Channels 2 or 4
- Memory 140 Mpts(Std.)
- Waveform capture rate Up to 110,000 waveforms per second
- Real Time Waveform Record, Replay & Analysis(Std. up to 200,000 frames)
- Lower noise floor, the Min. vertical sensitivity is 1mV/div
- Innovative "UltraVision" technology
- A variety of Trigger functions and Automatic measurements with statistics
- Support serial bus trigger(Std.) and decoding(Opt.)
- Complete connectivity: USB Host& Device, LAN(LXI), AUX, VGA, USB-GPIB(Opt.)
- 9 inch WVGA(800X480) Display with 256 level intensity grading display

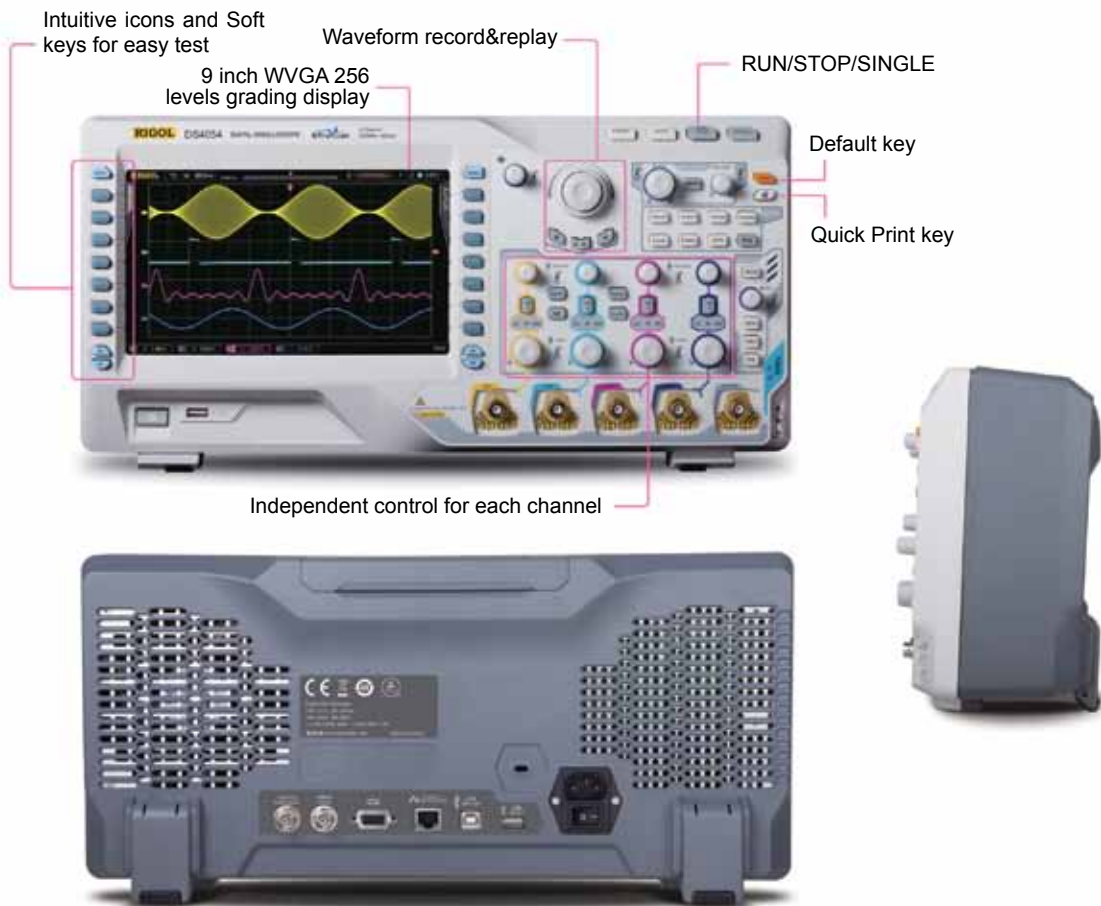

Product Dimensions: Width X Height X Depth = 440.0mm X 218.0 mm X 130.0 mm Weight: 4.8 kg ± 0.2 kg (Without Package)

## ► Innovative UltraVision Technology



- Deeper Memory Depth(Std.140Mpts)
- Higher Waveform capture rate (Up to 110,000 wfms/s)
- Real Time waveform Record,Replay & Analysis (Up to 200,000 frames)
- Multi-level intensity grading display(256 Levels)

## ► Features and Benefits

UltraVision: Up to 110K wfms/s Waveform capture rate

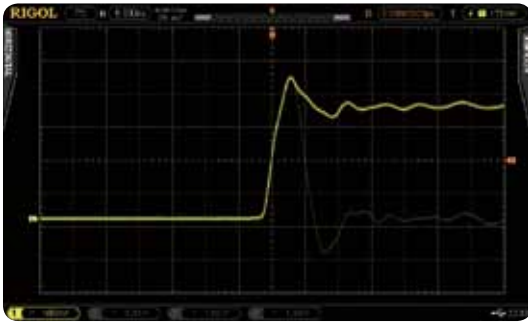

Find the infrequent problem easily

UltraVision: Realtime waveform record, replay, analysis function (std.)



- Up to 200,000 frames could be recorded
- "WaveFinder"-Dedicated data search knob
- Replay and analyze the recorded waveforms

UltraVision: Deeper Memory with up to 256-Level intensity grading display

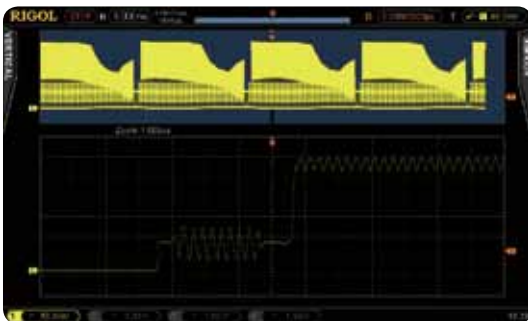

Provide the capability to see both the panorama and detail simultaneously

Advanced math function (user defined)



Mask test functions(Std.)

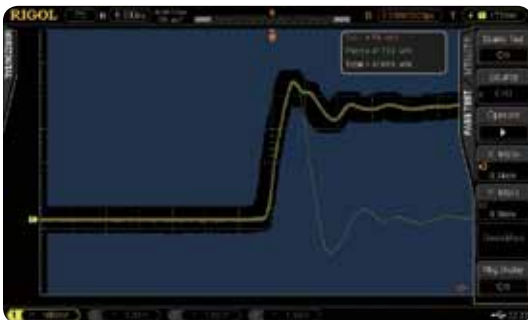

User defined Mask, Pass/Fail counts, Stop on Fail, Fail Alarm

Automatic measurements with statistics

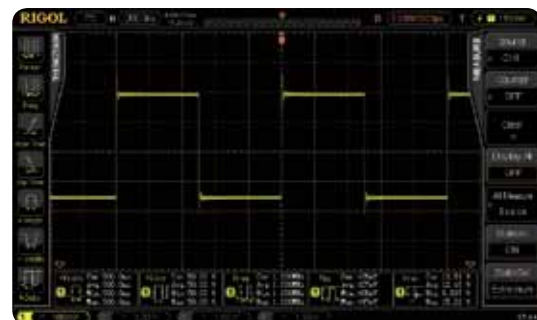

- Automatic measurements for Horizontal and vertical parameters
- Display up to 5 measurement items with statistics simultaneously
- Display all measurement items with the current value in the screen
- Intuitive icon and soft key operation for simplified testing

Serial bus decoding functions



Measurement History: Show the trend of the parameters

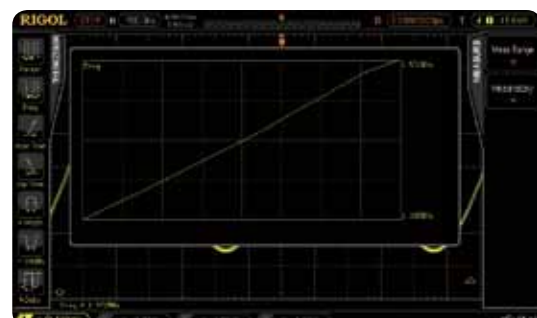



► **MSO4000 Series Mixed Signal Oscilloscope**



**Besides the powerful functions of DS4000, you could get more from MSO4000 with:**

- 16 Digital channels
- Sample rate of Digital channel up to 1 GSa/s
- Memory depth of Digital channel up to 28Mpts per channel
- Waveform capture rate of Digital channel up to 85,000wfms/s
- Real Time Waveform Record, Replay and analysis functions, up to 64,000 frames
- Triggering and Decoding across Analog and Digital channels
- Easy to be grouped for digital channels
- Support a variety of logic levels
- Time correlation display for both analog and digital signals

**Innovative UltraVision technology(Digital Channel)**



- Deeper Memory Depth(Std.28M pts per channel)
- Higher Waveform capture rate (Up to 85,000wfms/s)
- Real Time waveform record & replay(Up to 64,000 frames)
- Multi-level intensity grading display

Mixed Signal Analysis with analog and digital channels

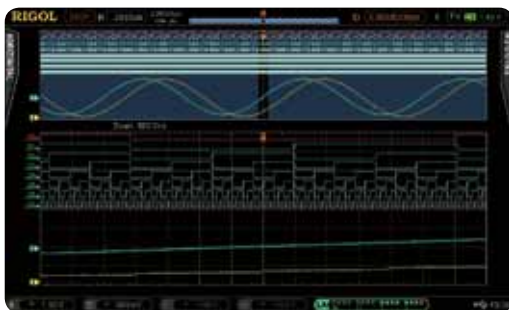

Easy to be grouped and labeled for digital channels



Serial bus triggering and decoding on digital channels



Support a variety of logic levels

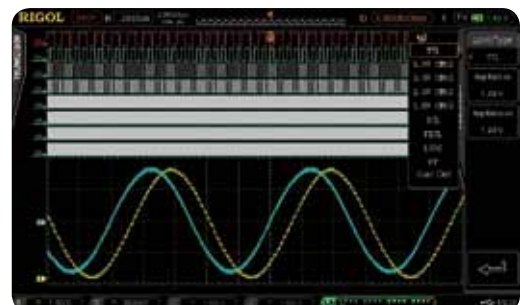

## ► Models and key Specs

Model Number	DS4054	DS4052	DS4034	DS4032	DS4024	DS4022	DS4014	DS4012
	MSO4054	MSO4052	MSO4034	MSO4032	MSO4024	MSO4022	MSO4014	MSO4012
Analog Channels	4	2	4	2	4	2	4	2
Digital Channels	16							
Max. Sample rate	<b>Analog Channel:</b> Max. 4 GSa/s half channel, 2GSa/s per channel <b>Digital Channel:</b> Max. 1 GSa/s per channel							
Max. Memory Depth	<b>Analog Channel:</b> Std. up to 140 Mpts half channel, 70 Mpts per channel <b>Digital Channel:</b> Std. up to 28 Mpts per channel (only MSO)							
Waveform Capture rate	Up to 110,000 wfms/s(Digital channel Closed);85,000 wfms/s(Digital channel Opened)							
Time Base Accuracy	≤ ±4 ppm							
Time Base Drift	≤ ±2 ppm/Year							
Timebase Scale	MSO405X/DS405X: 1 ns/div to 1000 s/div MSO403X/DS403X: 2 ns/div to 1000 s/div MSO402X/DS402X: 2 ns/div to 1000 s/div MSO401X/DS401X: 5 ns/div to 1000 s/div							
Input Impedance	<b>Analog channel:</b> (1MΩ±1%)    (14 pF±3 pF) or 50Ω±1.5% <b>Digital channel:</b> (101kΩ±1%)    (8 pF±2 pF)							
Vertical Scale	<b>Analog channel:</b> 1 mV/div to 5 V/div(1 MΩ);1 mV/div to 1 V/div(50 Ω) <b>Digital channel:</b> Threshold per set of 8 channels User-defined threshold range ±20V in 10mV step Threshold accuracy ±(100 mV + 3% of threshold setting) Minimum voltage swing 500 mVpp							
DC Gain Accuracy	±2% full scale							
Bandwidth Limit	405x/ 403x: 20 MHz/100MHz/200MHz 402x: 20 MHz/100MHz 401x: 20 MHz							
Real Time waveform Record, Replay and Analysis function	Analog channel:Up to 200,000 frames(Std.)							
Std, trigger functions	Standard: Edge,Pulse width,Nth Edge,Pattern Option:RS232,I2C,SPI,CAN,USB,FlexRay							
Serial Bus decoding (Both Analog & Digital channels)	Standard: Parallel Option: RS232,I2C,SPI,CAN,FlexRay							
Math functions	<b>Analog channel:</b> A+B,A-B,A×B,A/B,FFT,Advanced Math,Logic operation <b>Digital channel:</b> Logic operation							
Auto Measurements	<b>Analog channel:</b> Vpp, Vamp, Vmax, Vmin, Vtop, Vbase, Vavg, Vrms, Overshoot, Preshoot, Area,Period Area, Freq,Period, Rise Time, Fall Time,Width, -Width, +Duty, -Duty, Delay A→B rising edge, Delay A→B falling edge,Phase A→B rising edge,Phase A→B falling edge <b>Digital channel:</b> Freq,Period, Rise Time, Fall Time,Width, -Width, +Duty, -Duty, Delay A→B rising edge,Delay A→B falling edge,Phase A→B rising edge,Phase A→B falling edge							
Connectivities	Dual USB HOST,USB DEVICE,LAN,VGA,10MHz Input/Output, Aux Output(TrigOut, Quick Edge, PassFail, Calibration, GND)							
Display	9.0 inches WVGA(800X480) TFT LCD display,256 intensity grading level							
Size (W×H×D)	440.0 mm× 218.0 mm×130.0 mm							
Weight	4.8 kg ± 0.2 kg (Without Package)							
Std. Probes	2 or 4 sets RP3500A 500MHz BW Passive Probe;1 set RPL2316 LA Probe(MSO only)							

## ► Ordering Information

Model	Description	Order Number
	DS4012 (100 MHz, 4 GSa/s, 140Mpts, 2-channel Digital Oscilloscope)	DS4012
	DS4014 (100 MHz, 4 GSa/s, 140Mpts, 4-channel Digital Oscilloscope)	DS4014
	DS4022 (200 MHz, 4 GSa/s, 140Mpts, 2-channel Digital Oscilloscope)	DS4022
	DS4024 (200 MHz, 4 GSa/s, 140Mpts, 4-channel Digital Oscilloscope)	DS4024
	DS4032 (350 MHz, 4 GSa/s, 140Mpts, 2-channel Digital Oscilloscope)	DS4032
	DS4034 (350 MHz, 4 GSa/s, 140Mpts, 4-channel Digital Oscilloscope)	DS4034
	DS4052 (500 MHz, 4 GSa/s, 140Mpts, 2-channel Digital Oscilloscope)	DS4052
	DS4054 (500 MHz, 4 GSa/s, 140Mpts, 4-channel Digital Oscilloscope)	DS4054
	MSO4012 (100 MHz, 4 GSa/s, 140Mpts, 2+16 channel Digital Oscilloscope)	MSO4012
	MSO4014 (100 MHz, 4 GSa/s, 140Mpts, 4+16 channel Digital Oscilloscope)	MSO4014
	MSO4022 (200 MHz, 4 GSa/s, 140Mpts, 2+16 channel Digital Oscilloscope)	MSO4022
	MSO4024 (200 MHz, 4 GSa/s, 140Mpts, 4+16 channel Digital Oscilloscope)	MSO4024
	MSO4032 (350 MHz, 4 GSa/s, 140Mpts, 2+16 channel Digital Oscilloscope)	MSO4032
	MSO4034 (350 MHz, 4 GSa/s, 140Mpts, 4+16 channel Digital Oscilloscope)	MSO4034
	MSO4052 (500 MHz, 4 GSa/s, 140Mpts, 2+16 channel Digital Oscilloscope)	MSO4052
	MSO4054 (500 MHz, 4 GSa/s, 140Mpts, 4+16 channel Digital Oscilloscope)	MSO4054
Standard Accessories	Power Cord conforming to the standard of the country	-
	Front Panel Cover	FPCS-DS4000
	USB Data Cable	CB-USBA-USBFF-150
	2 or 4 Passive Probes (500 MHz)	RP3500A
	1 Set logic analysis probe	RPL2316
	Quick Guide	-
	Resource CD (User's Guide and Application Software)	-
Optional Accessories	Active Differential Probe (1.5 GHz)	RP7150
	Rack Mount Kit	RM-DS4000
Decoding Options	RS232/UART Decoding Kit	SD-RS232-DS4000
	I2C/SPI Decoding Kit	SD-I2C/SPI-DS4000
	CAN Decoding Kit	SD-CAN-DS4000
	FlexRay Decoding Kit	SD-FlexRay-DS4000

# DS2000A Series Digital Oscilloscope



## ► Features and Benefits

- Bandwidth up to 300MHz, standard 50Ω input
- Wider vertical range(500uV/div ~ 10V/div), lower noise floor
- Max. Sample Rate 2G Sa/s
- Memory Depth up to 14Mpts(Std.), 56Mpts(Opt.)
- Innovative "UltraVision" Technology
- Waveform capture rate up to 50,000 wf/s
- Up to 256 Levels intensity grading waveform display
- Up to 65,000 frames Hardware based Real Time waveform, Record, Replay & Analysis functions(Std.)
- A variety of trigger and serial bus Decoding functions(RS232,I2C,SPI,CAN)
- Built-in 2 Ch Waveform generator (DS2000A-S)
- Complete connectivities: USB Host& Device, LAN(LXI), AUX
- Compact size, light weight, easy to use
- 8 inch TFT (800x480) WVGA

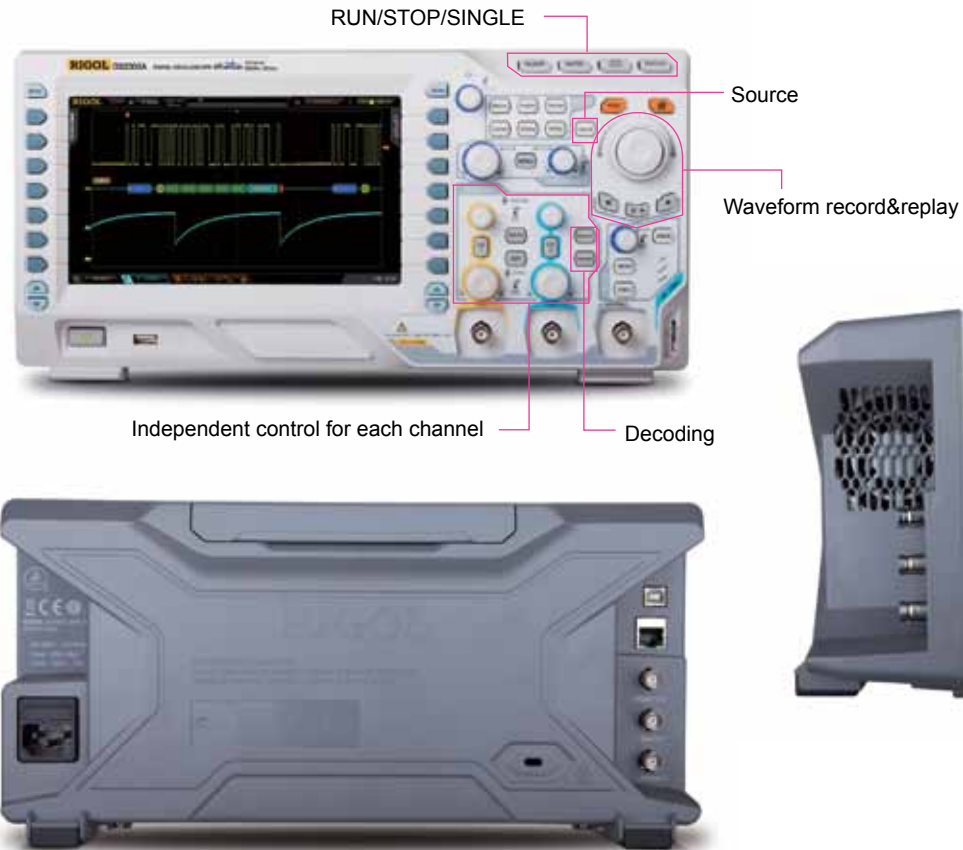

Product Dimensions: Width X Height X Depth=361.6 mm×179.6 mm×130.8 mm Weight: 3.9 kg ± 0.2 kg(Without Package)

## ► Innovative UltraVision Technology



- Deeper Memory Depth(Std. 14Mpts, Opt. 56Mpts)
- Higher Waveform capture rate (Up to 50,000 wfms/s)
- Real Time waveform Record, Replay & Analysis (Up to 65,000 frames)
- Multi-level intensity grading display(Up to 256 Levels)



## ► Features and Benefits

Wider Vertical range(500uV/div~10V/div),Lower noise floor, Better for small signal capturing

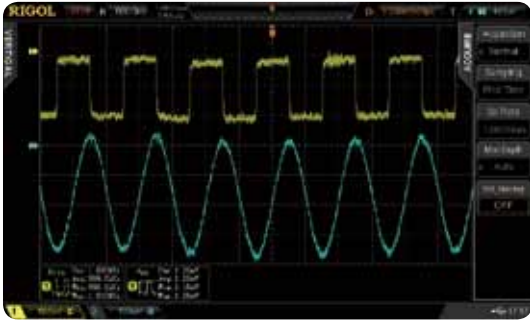

Versatile Trigger Functions(Runt, Nth Edge,Setup/ Hold ...)



UltraVision: Deeper memory(Std.14Mpts,Opt.56Mpts)

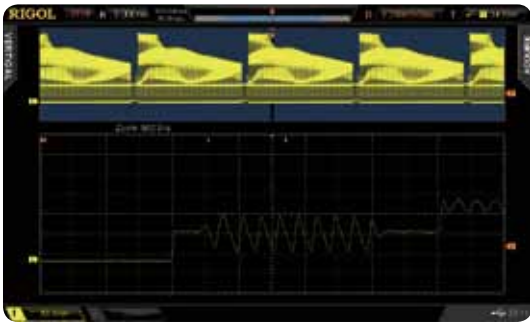

UltraVision: Up to 50,000 wfms/s Waveform capture rate



UltraVision:Realtime waveform record,replay,analysis function (std.)



UltraVision: Deeper Memory with Multi-Level intensity grading display(Up to 256 levels)

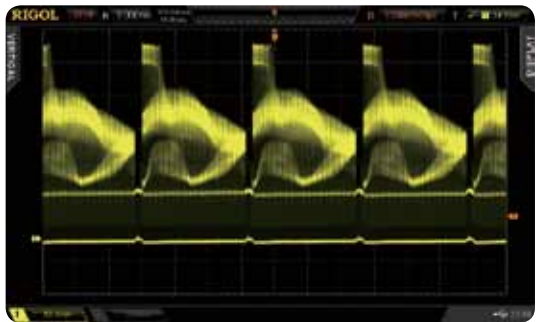

Serial bus Trigger&Decoding functions (RS232,I2C,SPI,CAN)



Built-in 2CH Source (DS2000A-S)

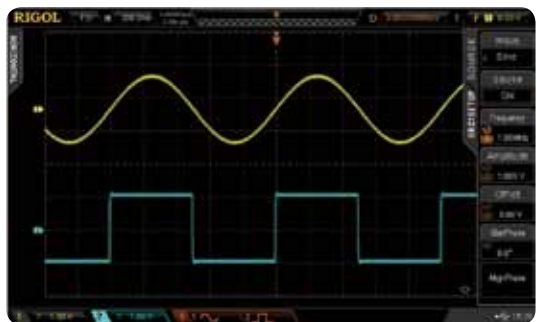



## ► Digital Oscilloscope

Model Number	DS2072A	DS2072A-S	DS2102A	DS2102A-S	DS2202A	DS2202A-S	DS2302A	DS2302A-S
Analog BW	70 MHz		100MHz		200 MHz		300 MHz	
Channels	2							
Max. Sample rate	2GSa/s (Single-channel)				1GSa/s(Dual-channel)			
Max. Memory Depth	14Mpts(std.)				56Mpts(option)			
Max. Waveform Capture rate	50,000 wfms/s							
Time Base Accuracy	≤ ±25 ppm							
Time Base Drift	≤ ±5 ppm/Year							
Timebase Scale	DS2302A, DS2302A-S: 1 ns/div to 1000 s/div				DS2202A,DS2202A-S: 2 ns/div to 1000 s/div			
	DS2102A/DS2102A-S/DS2072A/DS2702A-S: 5 ns/div to 50 s/div							
Input Impedance	(1MΩ±1%)    (16 pF±3 pF) or 50Ω±1.5%							
Vertical Scale	500 uV/div to 10 V/div							
DC Gain Accuracy	±2% FS							
Bandwidth Limit	DS2202A, DS2202A-S, DS2302A, DS2302A-S: 20 MHz/100MHz DS2102A/DS2102A-S/DS2072A/DS2702A-S: 20 MHz							
Real Time waveform Record, Replay and Analysis function	Up to 65, 000 Frames							
Std. trigger functions	Edge, Pulse width, Runt, Slope, Video, Pattern, Setup/Hold, RS232, I2C, SPI							
Optional trigger functions	Windows, Nth Edge, HDTV, Delay, Time Out, Duration, USB, CAN							
Std. Bus decoding	Parallel Bus							
Optional Serial Bus decoding	RS232,I2C,SPI,CAN							
Math functions	A+B, A-B, A×B, A/B, FFT, Advanced Math, Logic operation							
Auto Measurements	Vpp, Vamp, Vmax, Vmin, Vtop, Vbase, Vavg, Vrms, Overshoot, Preshoot, Area, Period Area, Freq,Period, Rise Time, Fall Time,Width, -Width, +Duty, -Duty, Delay A→B rising edge,Delay A→B falling edge, Phase A→B rising edge,Phase A→B falling edge							
Connectivities	USB HOST& DEVICE, LAN(LXI), Aux Output(TrigOut, PassFail) ,Support USB-GPIB(Opt.)							
Display	8.0 inches WVGA(800X480) TFT LCD display, 256 intensity grading level							
Size (W×H×D)	361.6 mm× 179.6 mm×130.8 mm							
Weight	3.9 kg ± 0.2 kg (Without Package)							
Std. Probes	RP3300 350MHz BW Passive Probe:2 sets							

Built in 2CH 25MHz Function/Arb Generator (DS2000A-S)	
Channels	2
Sample rate	200MSa/s
Vertical Resolution	14bits
Max. Output Frequency	25MHz
Amplitude Range	20mVpp~5Vpp (High Z)
Waveform Length	16kpts
Standard Waveforms	Sine, Square, Ramp, Pulse, Noise, DC
Arbitrary Waveforms	Sinc, ExpRise, ExpFall, ECG, Gauss, Lorentz, Haversine ,User Defined

## ► Ordering Information

Model	Description	Order Number
	70MHz,2-channel	DS2072A
	70MHz,2-channel + 2-channel Signal Source	DS2072A-S
	100MHz,2-channel	DS2102A
	100MHz,2-channel + 2-channel Signal Source	DS2102A-S
	200MHz,2-channel	DS2202A
	200MHz,2-channel + 2-channel Signal Source	DS2202A-S
	300MHz,2-channel	DS2302A
	300MHz,2-channel + 2-channel Signal Source	DS2302A-S
Standard Accessories	Power Cord conforming to the standard of the country	-
	USB Data Cable	CB-USBA-USBB-FF-150
	2 Passive Probes (350 MHz)	RP3300A
	Quick Guide	-
	Resource CD (User's Guide and Application Software)	-
Optional Accessories	Rack Mount Kit	RM-DS2000A
Deep Memory Option	56Mpts(single channel)/28Mpts(dual channel)	MEM-DS2000A
Advanced trigger functions	Windows, Nth Edge,HDTV,Delay, Time Out, Duration, USB	AT-DS2000A
Decoding Options	RS232,I2C,SPI Decoding Kit	SD-DS2000A
	CAN Analysis kit(Trigger+Decoding)	CAN-DS2000A

# DS1000Z Series Digital Oscilloscope



- **Features and Benefits**
- 1G Sa/s Real-time Sample Rate, 4 channels
  - 12Mpts (Std.) and 24Mpts (Opt.) Memory Depth
  - Up to 30,000wfms/s Waveform Capture Rate
  - Up to 60,000frames Real-time Waveform Record(Opt.)
  - Low noise floor, Dynamic Range: 1mV/div to 10V/div
  - Optional Serial Buses Triggering and Decoding
  - Built in 2 CH 25MHz waveform Generator(DS1000Z-S)
  - 7 Inch WVGA (800x480), multiple intensity levels waveform display
  - Connectivity: LAN(LXI Core Device 2011)
  - USB Host&Device, AUX,USB-GPIB(Opt.)

7 inch WVGA(800X480) TFT, Multiple intensity Level waveform display

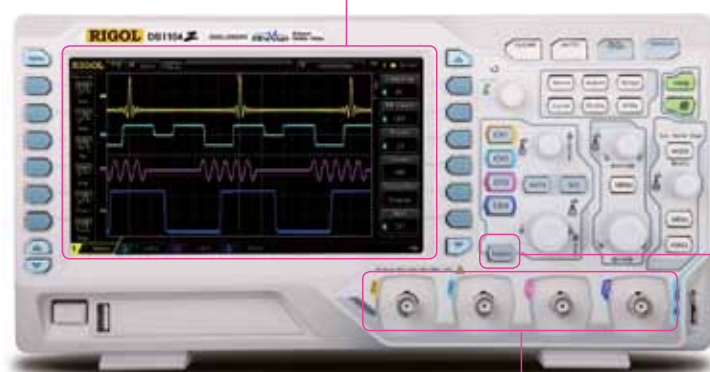

Built-in Source control button ( DS1000Z-S )

4 Channels



Product Dimensions: Width X Height X Depth=313.1 mm×160.8 mm×122.4 mm Weight: 3.2 kg ± 0.2 kg(Without Package)

► **Innovative UltraVision technology**



- Deeper Memory Depth (Std.12Mpts,Opt.24Mpts)
- Higher Waveform Capture Rate (Up to 30,000 wfms/s)
- Real Time Waveform Record&Replay (Up to 60,000 frames, opt.)
- Multi-level Intensity Grading Display

## ► Features and Benefits

4 Channels



UltraVision: Deeper memory(Std.12Mpts,Opt.24Mpts)



UltraVision: Up to 30,000 wfms/s Waveform capture rate



UltraVision: Multi-Level intensity grading display

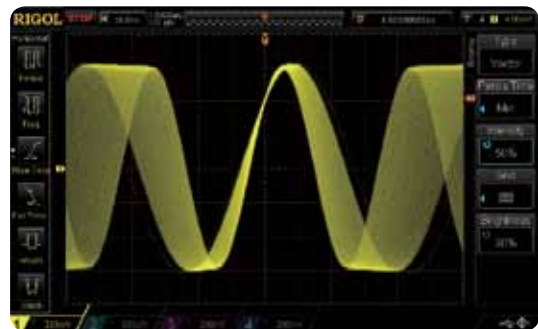

UltraVision:Realtime waveform Record,Replay, function (Opt.)



Built in 2 channel 25MHz Signal Source(DS1000Z-S)



Optional Serial Bus Triggering and Decoding functions(RS232,I2C,SPI)



Standard Mask test function



## ► Models and key Specs

Model Number	DS1074Z	DS1074Z-S	DS1104Z	DS1104Z-S
Analog BW	70 MHz		100MHz	
Channels	4			
Max. Sample rate	1GSa/s (Single-channel), 500MSa/s(Dual-channel), 250MSa/s (Full-channel)			
Max. Memory Depth	12Mpts (std.), 24Mpts(option)			
Max. Waveform Capture rate	Up to 30,000 wfms/s			
Time Base Accuracy	≤ ±25 ppm			
Time Base Drift	≤ ±5 ppm/Year			
Timebase Scale	5 ns/div to 50 s/div			
Input Impedance	(1MΩ±2%)    (13 pF±3 pF)			
Vertical Scale	1 mV/div to 10 V/div			
DC Gain Accuracy	±2% FS(CH1),±3% FS(CH2,3,4)			
Bandwidth Limit	20 MHz			
Real Time waveform Record, Replay and Analysis function	Up to 60,000 Frames(Opt.)			
Std. trigger functions	Edge,Pulse width,Slope,Video,Pattern,Duration			
Optional trigger functions	RS232,I2C,SPI,RS232,Runt,Windows,Nth Edge,Delay,Time Out			
Std. Bus decoding	Parallel Bus			
Optional Serial Bus decoding	RS232,I2C,SPI			
Math functions	A+B,A-B,A×B,A/B,FFT,AND,OR,NOT,XOR,Diff,Intg,Lg,Sqrt			
Auto Measurements	Vpp, Vamp, Vmax, Vmin, Vtop, Vbase, Vavg, Single Period Vavg, Vrms, Single Period Vrms,Overshoot, Preshoot, Area,Period Area, Freq,Period, Rise Time, Fall Time,Width, -Width, +Duty, -Duty, Delay A→B rising edge, Delay A→B falling edge,Phase A→B rising edge,Phase A→B falling edge			
Connectivities	USB HOST& DEVICE,LAN(LXI),Aux Output(TrigOut, PassFail) ,Support USB-GPIB(Opt.)			
Display	7.0 inches WVGA(800X480) TFT LCD display,64 intensity grading level			
Size (W×H×D)	64 intensity grading level			
Weight	313.1 mm× 160.8 mm×122.4 mm			
Std. Probes	3.2 kg ± 0.2 kg (Without Package)			
	RP2200 150MHz BW Passive Probe:4 sets			

Built in 2CH 25MHz Function/Arb Generator ( DS1074Z-S,DS1104Z-S )

Channels	2
Sample rate	200MSa/s
Vertical Resolution	14bits
Max. Output Frequency	25MHz
Amplitude Range	20mVpp~5Vpp (High Z)
Waveform Length	16kpts
Standard Waveforms	Sine,Square,Ramp,Pulse,Noise,DC

## ► Ordering Information

	Description	Order Number
Model	DS1074Z (70MHz,4 CH Scope)	DS1074Z
	DS1074Z-S (70MHz,4 CH Scope + 25MHz,2 CH Source)	DS1074Z-S
	DS1104Z (100MHz,4 CH Scope)	DS1104Z
	DS1104Z-S (100MHz,4 CH Scope + 25MHz,2 CH Source)	DS1104Z-S
	Power Cord conforming to the standard of the country	-
	USB Data Cable	CB-USBA-USBB-FF-150
Standard Accessories	4 Passive Probes (150 MHz)	RP2200
	Quick Guide	-
	Resource CD (User's Guide and Application Software)	-
Optional Accessories	Rack Mount Kit	RM-DS1000Z
Deep Memory Option	24Mpts (1 CH)/12Mpts (2 CH)/6Mpts (4 CH)Memory	MEM-DS1000Z
Waveform record option	Real Time Waveform Record and Replay function	REC-DS1000Z
Advanced Trigger option	RS232/UART,I2C,SPI,Runt,Windows,Nth Edge, Delay,Time Out	AT-DS1000Z
Serial Bus Analysis Option	RS232/UART,I2C,SPI Trigger and Decoding function	SA-DS1000Z



# DS1000B Series Digital Oscilloscope



## ► Features and Benefits

- 4 Analog Channels
- 2GSa/s Real-time Sample Rate
- Versatile Trigger Functions: Edge, Video, Pulse, Pattern and Alternate
- Waveform Record and Replay function
- Built in FFT and Digital Filters
- Pass/Fail Test
- High Definition Display (320x240)
- Connectivity: USB Host & Device, LAN(LXI-C), Support PictBridge

## ► Key Specifications

Model	DS1204B	DS1104B	DS1074B
Bandwidth	200 MHz	100 MHz	70 MHz
Memory Depth	Up to 16 kpts (half channel), 8 kpts (each channel)		
Channels	4 channels + external trigger		
Real-time Sample Rate	2 GSa/s (half channel), 1 GSa/s (each channel)		
Equivalent-time Sample Rate	50 GSa/s	25 GSa/s	10 GSa/s
Rise Time	<1.75ns	<3.5ns	<5ns
Input Impedance	1 MΩ    18 pF		
Timebase Range	1 ns/div ~ 50 s/div	2 ns/div ~ 50 s/div	5 ns/div ~ 50 s/div
Trigger modes	Edge, Video, Pulse Width, Alternate, pattern trigger across 4 analog channels		
Vertical Sensitivity	2 mV/div ~ 10 V/div		
Vertical Resolution	8 bits		
Maximum Input voltage	All Inputs 1MΩ  18pF 300Vrms Max CAT I		



4 Analog Channels

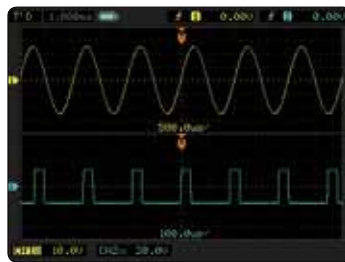

Alternative Trigger



2G Sa/s Sample Rate



Pass/Fail Test



Pattern Trigger



Waveform Record

# DS1000 Series Digital Oscilloscope



## ► Features and Benefits

- 1G Sa/s Real time Sample Rate
- Memory Depth upto 1Mpts
- 2+16 Channels Mixed Signal Oscilloscope(MSO)(DS1000D)
- Versatile Trigger Functions:
  - Edge, Video, Pulse, Slope, Aalternate, Pattern(DS1000D), Duration(DS1000D)
- Trigger Sensitivity could be adjusted
- Waveform Record and Replay function
- Built in FFT and Digital Filters
- Pass/Fail Test
- Connectivity: USB Host & Device, RS-232, Support PictBridge

## ► Specifications

Model	DS1102E	DS1052E
	DS1102D	DS1052D
Bandwidth	100MHz	50MHz
Channels	2 Channels + External Trigger	
Real-time Sample Rate	1 GSa/s (Single Channel), 500 MSa/s (Dual Channels)	
Equivalent-time Sample Rate	25 GSa/s	10 GSa/s
Rise Time	3.5 ns	7 ns

Memory Depth	Mode	Max. Sample Rate	Normal Mode	Long Memory Mode
	One Channel		1 GSa/s	16 kpts
Dual Channels		500 MSa/s or less	16 kpts	1 Mpts
		500 MSa/s or less	8 kpts	N.A.
		250 MSa/s or less	8 kpts	512 kpts
Timebase Range	2 ns/div ~ 50 s/div		5 ns/div ~ 50 s/div	
Trigger Modes	Edge, Video, Pulse, Slope, Aalternate, Pattern(DS1000D), Duration(DS1000D)			
Vertical Resolution	8 bits			
Vertical Sensitivity	2 mV/div ~ 10 V/div			
Maximum Input Voltage	All inputs 1 MΩ    15 pF 300 V RMS CAT I			

MSO Logic Analyzer	DS1102D	DS1052D
Channels	16 logic Channels	
Sample Rate	200 MSa/s (each channel)	
Record Length	512 kpts (each channel)	
Trigger Modes	Pattern, Duration	
Threshold Selections	TTL=1.4 V, CMOS=2.5 V, ECL=-1.3 V, USER=-8 V to + 8 V	

## ► DS1000D Mixed Signal Oscilloscope(2+16 channels)



Logic Analyzer Module



**Pattern Trigger**  
The trigger condition is a combination of the level of the signal and the edge



**Duration Trigger**  
A combination of Pattern Trigger and Pulse Width Trigger capabilities make isolation of events easy

## ► Deep Memory

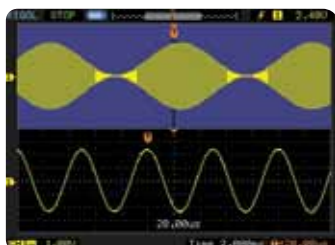

1Mpts Memory

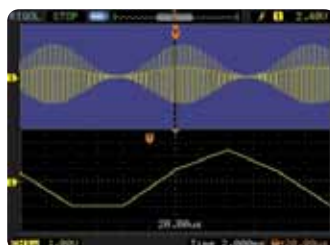

2Kpts Memory









See both the envelop and the detail of the waveform

# RIGOL Digital Scope Probes

## ► RIGOL Passive Probes

Model Number	Type	Description
 RP2200	High Z Probe	1X: DC~7MHz 10X:DC~150MHz Compatibility: All RIGOL Scopes.
 RP3300A	High Z Probe	1X: DC~8MHz 10X:DC~350MHz Compatibility: All RIGOL Scopes.
 RP3500A	High Z Probe	DC~500MHz Compatibility: All RIGOL Scopes.
 RP5600A	High Z Probe	DC~600MHz Compatibility: DS4000,6000 Series.
 RP6150A	Low Z Probe	DC~1.5GHz Compatibility: DS4000,6000 Series.
 RP1300H	High Voltage Probe	DC~300MHz CATI 2000V(DC+AC), CATII 1500 V(DC+AC) Compatibility: All RIGOL Scopes.
 RP1050H	High Voltage Probe	DC~50MHz DC:0~15KV DC,AC:pulse <=30KVp-p, AC:sine wave <=10KVrms Compatibility: All RIGOL Scopes.
 RPL2316		Logic analysis Probe(For MSO4000 only)
 RT50J		50ohm Impedance adapter(2W,1GHz)

## ► RIGOL Active & Current Probes

Model Number	Type	Description
 RP7150	Differential /Single ended Probe	BW:DC~1.5GHz,30V Peak, CAT I Compatibility: DS4000, 6000 series.
 RP1001C	Current Probe	BW:DC~300kHz, Max.DC: ± 100A, AC P-P:200A,AC RMS:70A Compatibility: All RIGOL Scopes.
 RP1002C	Current Probe	BW:DC~1MHz, Max.DC: ± 70A, AC P-P:140A,AC RMS:50A Compatibility: All RIGOL Scopes.
 RP1003C	Current Probe	BW:DC~50MHz, Max.AC RMS:30A AC Peak:50A(Noncontinuous) Compatibility: All RIGOL Scopes. Must order RP1000P Power supply.
 RP1004C	Current Probe	BW:DC~100MHz, Max. AC RMS:30A, AC Peak:50A(Noncontinuous) Compatibility: All RIGOL Scopes. Must order RP1000P Power supply.
 RP1005C	Current Probe	BW:DC~10MHz, Max.150 A rms, 300 A peak (Noncontinuous), 500 A peak (@pulse width <=30 ms) Compatibility: All RIGOL Scopes. Must order RP1000P Power supply.
 RP1000P	Power Supply	Power supply for RP1003C,RP1004C,RP1005C, support 4 channels.
 RP1025D	High Voltage Differential Probe	BW:25MHz; Max. Voltage ≤ 1400Vpp Compatibility: All RIGOL Scopes.
 RP1050D	High Voltage Differential Probe	BW:50MHz; Max. Voltage ≤ 7000Vpp Compatibility: All RIGOL Scopes.
 RP1100D	High Voltage Differential Probe	BW:100MHz; Max. Voltage ≤ 7000Vpp Compatibility: All RIGOL scopes

# DSA1000 Series Spectrum Analyzer



## ► Features and Benefits

- All-digital IF Technology
- Displayed Average Noise Level (DANL) Up to -148dBm(DSA1030A), -138dBm(DSA1030), -120dBm(DSA1020)
- Phase Noise up to -88dBc/Hz (DSA1030A,@10kHz offset), -80dBc/Hz (DSA1030/DSA1020,@10kHz offset)
- Total Amplitude Accuracy:<1.0dB(DSA1030A),<1.5dB(DSA1030/1020)
- Minimum Resolution Bandwidth (RBW): 10Hz(DSA1030A), 100Hz(DSA1030/1020)
- 3GHz Tracking Generator (DSA1030A-TG,DSA1030-TG)
- Connectivity: USB Host& Device, LAN, VGA, USB-GPIB(Opt.)
- 8.5 Inch Display (800x480)



Product Dimensions: Width X Height X Depth = 399 mm × 223 mm × 159 mm Weight: 6.2 kg (Without Package)



► **Features and Benefits**

Distinguish the two nearby signals clearly with the 10Hz RBW

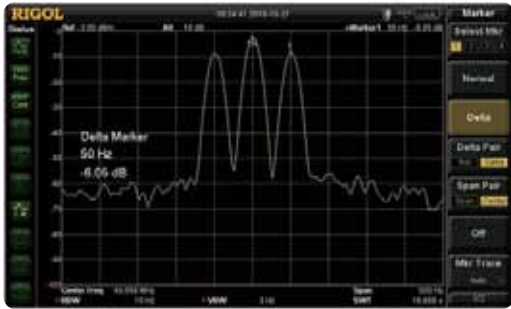

Readout the signal's Phase Noise directly by using the standard Noise Marker function

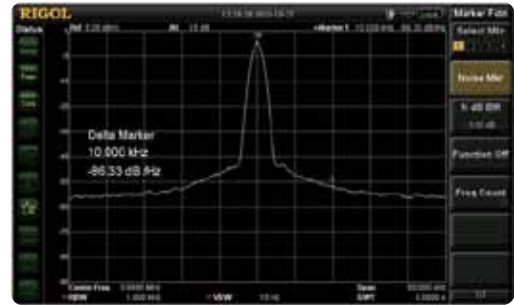

Compare the spectrums with different color trace

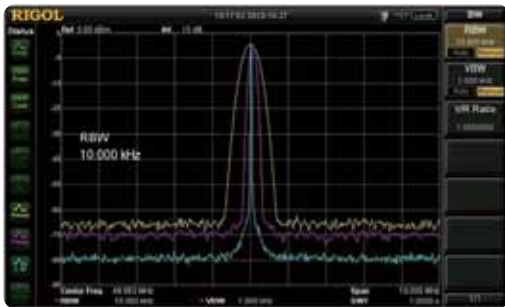

The advanced Channel Power measurement function



The advanced Occupied Bandwidth measurement function



Readout the Spectrum Peak values with the Peak table function

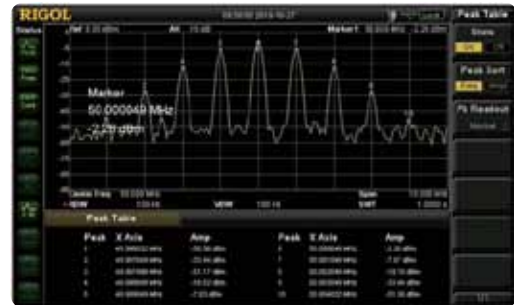

The advanced Harmonic distortion measurement function



Quasi-Peak Detector & EMI Filter (Standard)

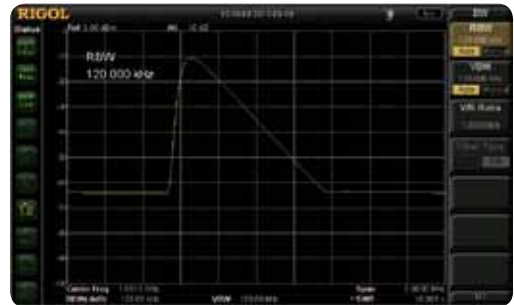

## ► Key Specifications

	DSA1030A/DSA1030A-TG	DSA1030/DSA1030-TG	DSA1020
Frequency Range	9 kHz~3 GHz		9 kHz~2 GHz
Frequency Resolution	1Hz		
Internal Frequency Reference	10 MHz		
Aging Rate	<3 ppm/year		
Temperature Drift	<3 ppm(20 °C to 30 °C)		
Marker Resolution	span / (sweep points-1)		
Marker Uncertainty	$\pm(\text{frequency indication} \times \text{frequency reference uncertainty} + 1\% \times \text{span} + 10\% \times \text{resolution bandwidth} + \text{marker resolution})$		
Resolution Bandwidth (-3 dB)	10 Hz to 1 MHz,in 1-3-10 sequence		100 Hz to 1 MHz,in 1-3-10 sequence
Video Bandwidth (-3 dB)	1 Hz to 3 MHz,in 1-3-10 sequence		
SSB phase noise (typical)	-88/Hz @10kHz Carrier Offset	-80dBc/Hz @10kHz Carrier Offset	
Level Measurement Uncertainty	<1.0dB	<1.5dB	
Displayed Average Noise Level (DANL):			
	0 dB RF Attenuation, RBW=10Hz, VBW=1Hz, RMS Average Detector, Trace Average $\geq$ 50, Input Impedance=50 $\Omega$ , Tracking Generator Off.	0 dB RF Attenuation, RBW=100 Hz, VBW=1Hz, RMS Average Detector, Trace Average $\geq$ 50, Input Impedance=50 $\Omega$ , Tracking Generator Off.	
	RBW = VBW = 10 Hz	RBW = 100 Hz, VBW = 10 Hz	
DANL (Preamp Off)			
100 kHz to 10 MHz	<-85 dBm-3 x (f/1 MHz) dB, typical -125 dBm	<-75 dBm-3 x (f/1 MHz) dB, typical -115 dBm	<-75 dBm-3 x (f/1 MHz) dB, typical -115 dBm
10 MHz to 2 or 2.5 GHz	<-127 dBm+3 x (f/1GHz) dB, typical -130 dBm	<-117 dBm+3 x (f/1 GHz) dB, typical -120 dBm	<-117 dBm+3 x (f/1 GHz) dB, typical -120 dBm
2.5 GHz to 3 GHz	<-115 dBm	<-105 dBm	
DANL (Preamp On)			
100 kHz to 1 MHz	<-103 dBm	<-93 dBm	
1 MHz to 10 MHz	<-103 dBm-3 x (f/1 MHz) dB, typical -143 dBm	<-93 dBm-3 x (f/1 MHz) dB, typical -133 dBm	
10 MHz to 2.5 GHz	<-145 dBm+3 x (f/1 GHz) dB, typical -148 dBm	<-135 dBm+3 x (f/1 GHz) dB, typical -138 dBm	
2.5 GHz to 3 GHz	<-133 dBm	<-123 dBm	
Preamplifier	Standard	Optional	None
Max. Damage Level	40 dBm(10 W)		
Trace Detectors	Normal, Positive-peak, Negative-peak, Sample, RMS, Voltage Average, Quasi-Peak		
Trace Functions	Clear Write, Max Hold, Min Hold, Average, Freeze, Blank		
Units of Level Axis	dBm, dBmV, dB $\mu$ V, nV, $\mu$ V, mV, V, nW, $\mu$ W, mW, W		
Tracking Generator(-TG)	10 MHz to 3 GHz, 9 kHz settable		None
10 MHz Reference Input/Output	Support		
Advanced Measurement Kit	Standard	Optional	None
Display	8.5" TFT LCD, 800*480 Resolution		
Interface	LAN, USB Host&Device, VGA, USB-GPIB(Optional)		
Weight	6.2 kg(Without Package)		
Dimensions (W×H×D)	399 mm × 223 mm × 159 mm		

## ► Options and Accessories

Harmonic Distortion	TOI	Emission Bandwidth
Channel Power	Occupied Bandwidth	
Time Domain Power	Carrier to Noise Ratio	
Adjacent Channel Power	Pass/Fail	

Advanced Measurement Kit  
(AMK-DSA1000)



Rack Mount Kit  
(RM-DSA1000)

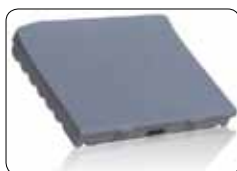

Lithium Battery Set  
(China Only)



Soft Carrying Bag  
(BAG-DSA1000)



VSWR Bridge  
(VB1020/VB1040)



USB to GPIB Converter  
(USB-GPIB)



Desk Mount Instrument Arm  
(ARM)



RF Demo Kit  
(TX1000)



DSA Accessories  
(DSA Utility Kit)



DSA PC Software  
(Ultra Spectrum)

## ► Ordering Information

	Description	Order Number
Model	Spectrum Analyzer, 9 kHz to 3 GHz, with preamplifier)	DSA1030A
	Spectrum Analyzer, 9 kHz to 3 GHz, with preamplifier,with track generator,factory installed.	DSA1030A-TG
Standard Accessories	Spectrum Analyzer, 9 kHz to 2 GHz	DSA1020
	Spectrum Analyzer, 9 kHz to 3 GHz	DSA1030
	Spectrum Analyzer, 9 kHz to 3 GHz, with track generator, factory installed.	DSA1030-TG
	Front Panel Cover	FPCS-DSA1000
	Quick Guide (Hard Copy)	-
Options	CDROM (User Guide, Programming Guide)	-
	USB Cable	CB-USBA-USBB-FF-150
	Power Cable	-
	DSA PC Software	Ultra Spectrum
	Preamplifier (not applied for DSA1020)	PA-DSA1030
	Advanced Measurement Kit (for DSA1030 , DSA1030-TG)	AMK-DSA1000
	VSWR Bridge (2GHz)	VB1020
	VSWR Bridge (4GHz)	VB1040
	USB to GPIB Interface Converter for Instrument	USB-GPIB
	11.1 V, 147 Wh Li-ion Battery Pack (only China)	BAT
Optional Accessories	RF Demo Kit(Transmitter)	TX1000
	DSA Accessories Package	DSA Utility Kit
	Rack Mount Kit	RM-DSA1000
	Front Panel Cover	FPCS-DSA1000
	Soft Carrying Bag	BAG-DSA1000
	Desk Mount Instrument Arm	ARM

# DSA800 Series Spectrum Analyzer



## ► Features and Benefits

- All-Digital IF Technology
- 9 kHz - 1.5 GHz Frequency Range
- Up to -135dBm Displayed Average Noise Level (DANL)
- -80dBc/Hz @ 10kHz Offset Phase Noise
- Total Amplitude Uncertainty < 1.5dB
- 100Hz Minimum Resolution Bandwidth (RBW)
- 1.5GHz Tracking Generator (DSA815-TG)
- Advanced Measurement functions (Opt.)
- EMI Filter & Quasi-Peak Detector Kit(Opt.)
- VSWR Measurement Kit(Opt.)
- Complete Connectivity: LAN,USB host,USB device,GPIB (Opt.)
- 8 Inch WVGA (800x480) Display
- Compact Size,Light weight design



Product Dimensions: Width X Height X Depth = 361.6 mm x 178.8 mm x 128 mm Weight: 4.25 kg (Without Package)

## ► Options and Accessories

Harmonic Distortion	TOI	Emission Bandwidth
Channel Power	Occupied Bandwidth	
Time Domain Power	Carrier to Noise Ratio	
Adjacent Channel Power	Pass/Fail	

Advanced Measurement Kit (AMK-DSA800)



Rack Mount Kit (RM-DSA800)



USB to GPIB Converter (USB-GPIB)



RF Demo Kit (TX1000)



DSA Accessories (DSA Utility Kit)



DSA PC Software (Ultra Spectrum)



VSWR Bridge (VB1020)



Soft Carrying Bag (BAG-G1)



## ► Features and Benefits

Distinguish the two nearby signals clearly with the 100Hz RBW

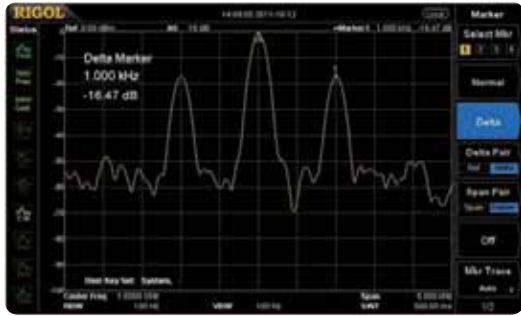

Compare the spectrums with different color trace

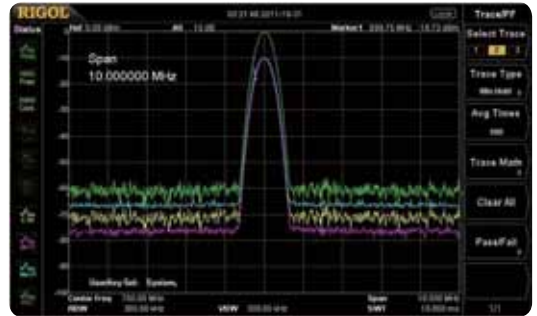

Readout the Spectrum Peak values with the Peak table function



Measure lower than -130dBm signal with the standard Preamp

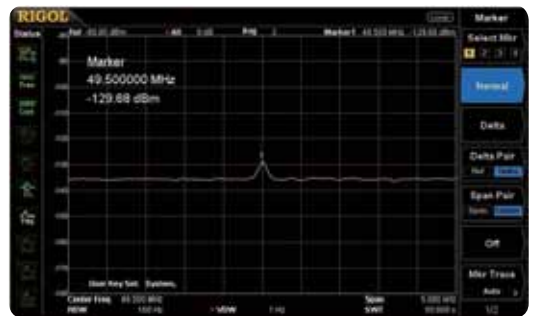

-80dBc/Hz @10 kHz offset Phase Noise

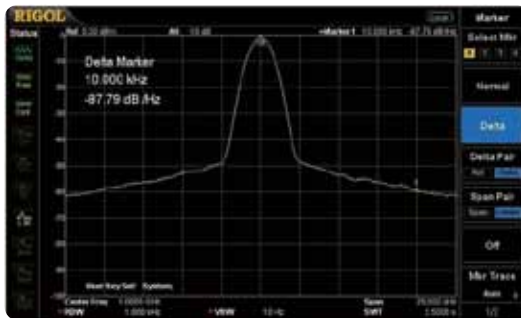

EMI Kit(EMI Filter & Quasi-Peak & Pass\_Fail)

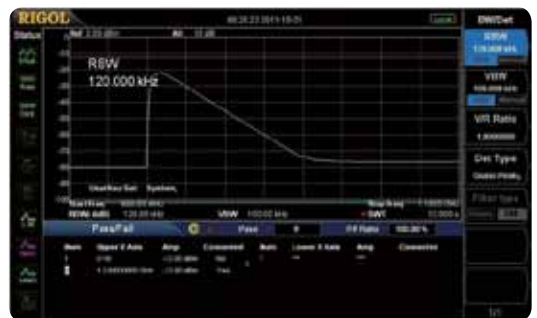

The GUI to control the RF Demo Kit (Transmitter) directly

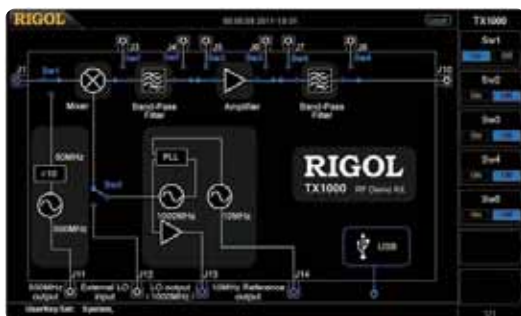

VSWR Measurement



## ► Key Specifications

Frequency Range	9kHz to 1.5GHz
Frequency Resolution	1Hz
Resolution Bandwidth (-3 dB)	100 Hz to 1 MHz, in 1-3-10 sequence
Video Bandwidth (-3 dB)	1 Hz to 3 MHz, in 1-3-10 sequence
SSB phase noise (typical)	<-80 dBc/Hz @10 kHz offset
Level Measurement Uncertainty	<1.5dB
Displayed Average Noise Level (DANL)	
0 dB RF Attenuation, RBW=VBW=100 Hz, Sample Detector, Trace Average ≥ 50, Input Impedance=50 Ω, Tracking Generator Off.	
Preamplifier Off	100 kHz to 1 MHz: <-90 dBm, typ. -110 dBm
	1 MHz to 1.5 GHz: <-110 dBm+6 x (f/1GHz) dB, typ. -115 dBm
Preamplifier On	100 kHz to 1 MHz:<-110 dBm typ. -130 dBm
	1 MHz to 1.5 GHz: <-130 dBm+6 x (f/1 GHz) dB, typ. -135 dBm
Preamplifier	Standard
Max. Damage Level	+30 dBm (1W)
Trace Detectors	Normal, Positive-peak, Negative-peak, Sample, RMS, Voltage Average, Quasi-peak
Trace Functions	Clear Write, Max Hold, Min Hold, Average, View, Blank
Units of Level Axis	dBm, dBmV, dBμV, nV, μV, mV, V, nW, μW, mW, W
Tracking Generator (-TG)	9 kHz to 1.5 GHz
10 MHz Reference Input/Output	Support
Advanced Measurement Kit	Optional
Display	8 inch 800 x 480 pixels Resolution 64k Colors
Interface	LAN,USB Host&Device,USB-GPIB(Optional)
Weight	4.25kg (With TG)
Dimensions (W×H×D)	361.6 mm x 178.8 mm x 128 mm

## ► Ordering Information

	Description	Order Number
Model	Spectrum Analyzer, 9 kHz to 1.5 GHz (with preamplifier)	DSA815
	Spectrum Analyzer, 9 kHz to 1.5 GHz, with preamplifier, with track generator, factory installed.	DSA815-TG
Standard Accessories	Quick Guide (Hard Copy)	-
	CDROM (User's Guide, Programming Guide)	-
	Power Cable	-
Options	EMI Filter & Quasi-Peak Detector Kit	EMI-DSA800
	VSWR Measure Kit	VSWR-DSA800
	VSWR Bridge (2 GHz)	VB1020
	DSA PC Software	Ultra Spectrum
	Advanced Measurement Kit	AMK-DSA800
	RF Demo Kit (Transmitter)	TX1000
	USB to GPIB Interface Converter for Instrument	USB-GPIB
	Rack Mount Kit	RM-DSA800
Optional Accessories	DSA Accessories Package Including:	DSA Utility Kit
	N-SMA Cable, BNC-BNC Cable, N-BNC Adapter, N-SMA Adapter, 75Ω-50Ω Adapter, Antenna 2 (900MHz/1.8GHz), Antenna 2 (2.4GHz)	
	Soft Carrying Bag	BAG-G1

# DSG3000 Series RF Signal Generator



## ► Features and Benefits

- Max. frequency 3GHz/6GHz
- Amplitude accuracy: <0.5dB (typical)
- Amplitude range: -130 dBm to +13 dBm
- Phase noise: <-110dBc/Hz@20kHz (typical)
- Standard 0.5ppm internal clock, 5ppb high stable clock (Opt.)
- Standard AM/FM/PM analog modulation
- Standard pulse modulation, on-off ratio up to 80dB; pulse train (Opt.)
- Support I/Q modulation and I/Q baseband output (Opt.)
- Support internal and external modulation modes
- Support mainstream USB Power Sensor
- Standard 2U height, provide rack mount kit
- Standard USB/LAN(LXI)/GPIB interfaces, SCPI command set

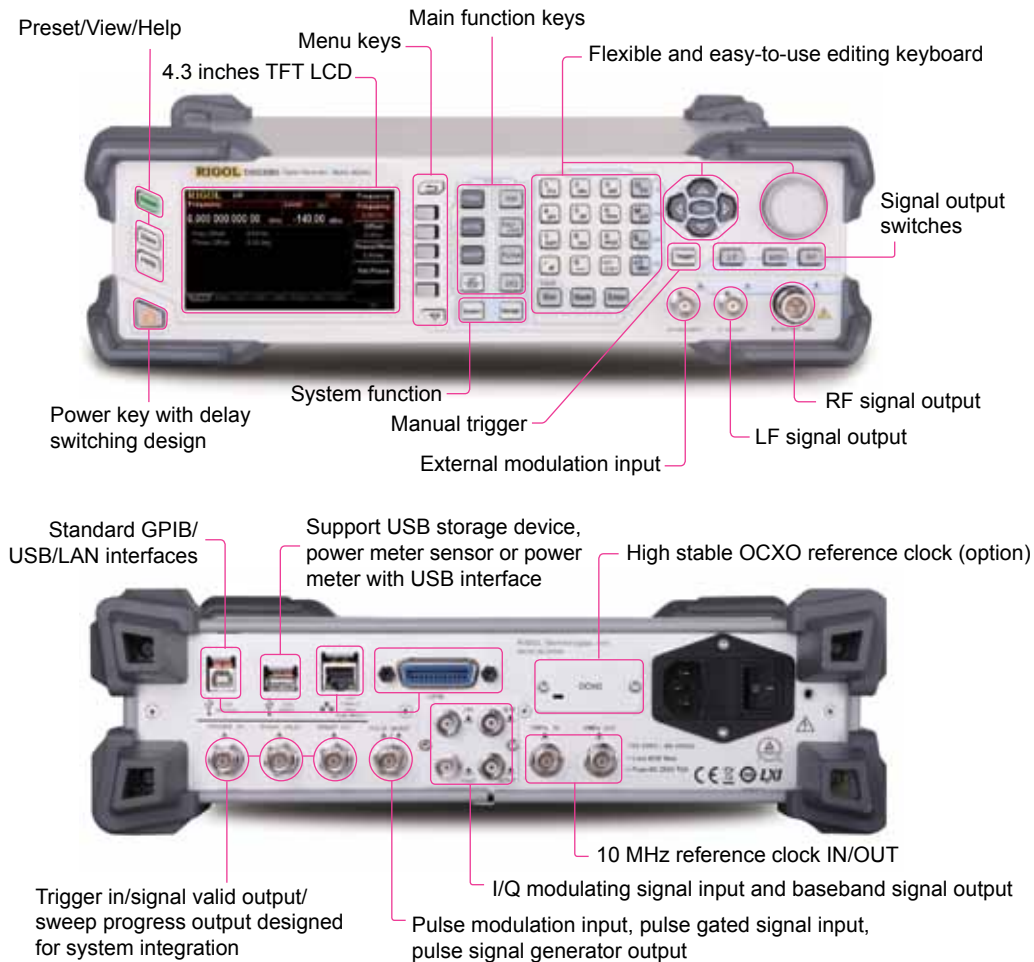

Dimensions: W × H × D = 364 mm × 112 mm × 420 mm; Weight: 6.4kg (without packaging)

## ► Main Functions

9kHz~3/6GHz +25dBm~-140dBm	<b>CW</b>	<b>LF</b>	Sine, Square, Triangle, Ramp, Swp-Sine	Internal modulation, External modulation	<b>AM</b>	<b>FM</b> <b>ΦM</b>	Internal modulation, External modulation
Frequency sweep, Amplitude sweep, Frequency and amplitude sweep	<b>Sweep</b>	<b>PMC</b>	Power meter controller, Test system automatic calibration	Internal modulation, External modulation, Pulse train generator, Pulse generator	<b>Pulse</b>	<b>I/Q</b>	Internal modulation, External modulation, I/Q baseband generator, Baseband output

## ► Features and Benefits

Measured +13dBm output, Harmonics VS frequency

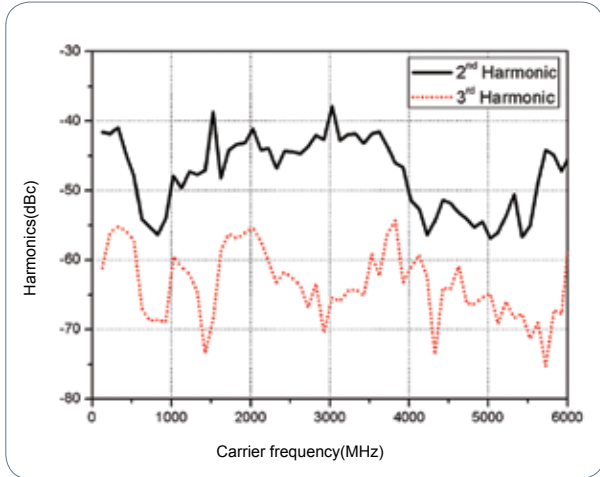

Measured 0dBm output, Harmonics VS frequency

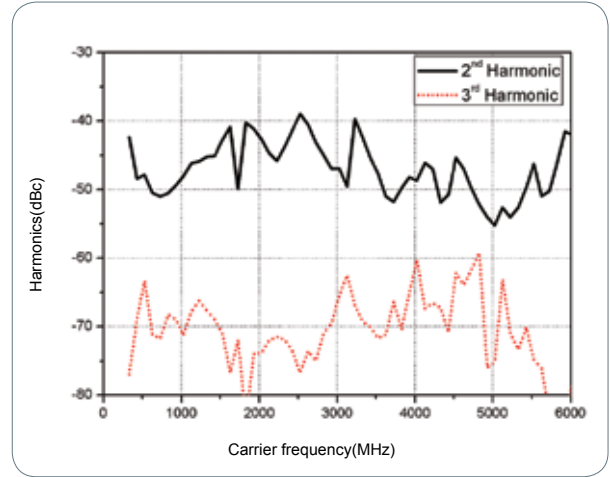

Measured SSB phase noise

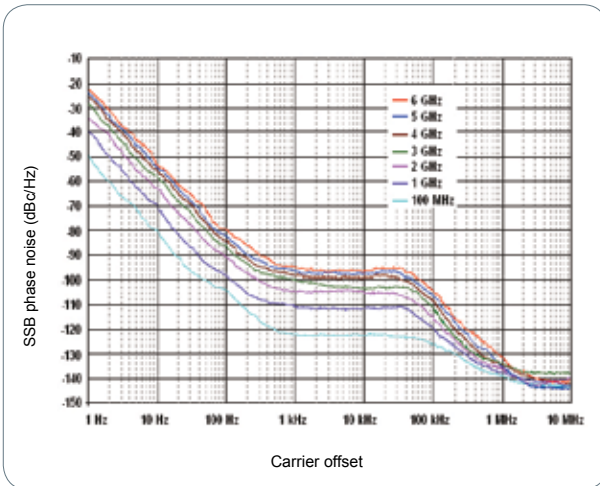

Minimum output level VS frequency

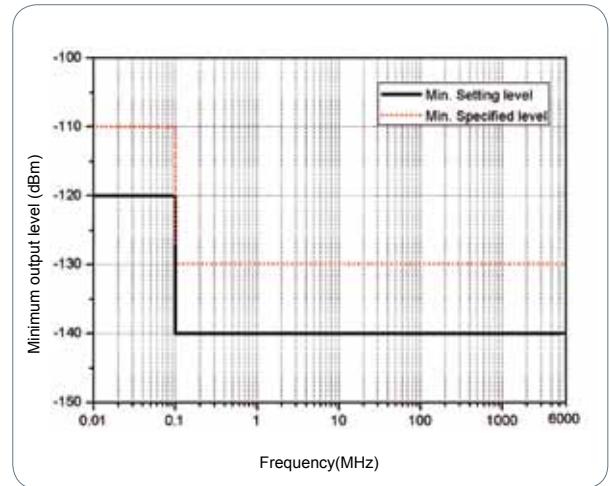

Maximum output level VS frequency

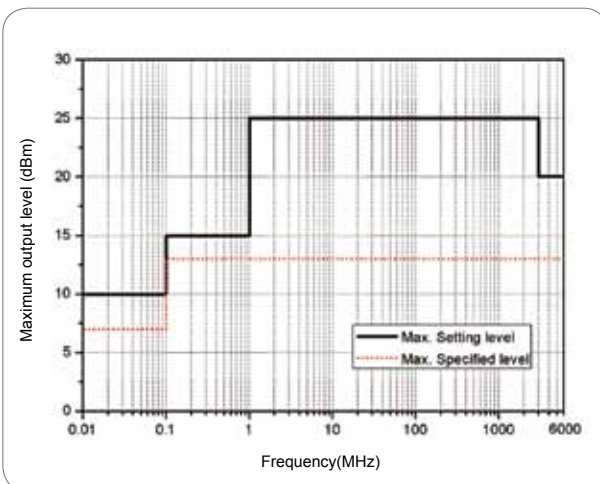

Measured maximum output level VS frequency

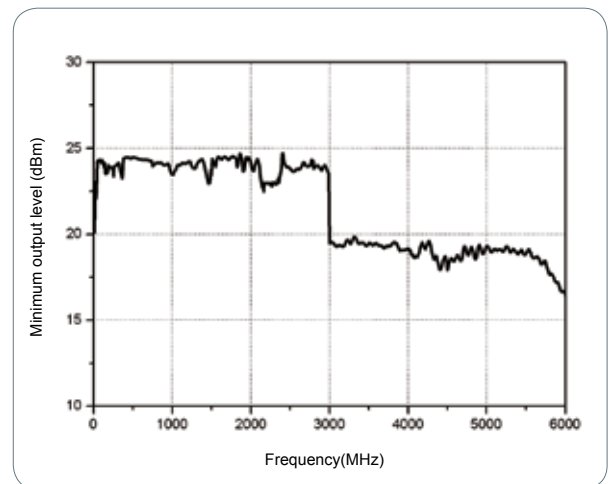



Measured level repeatability at 6GHz 0dBm, ALC ON, 25°C

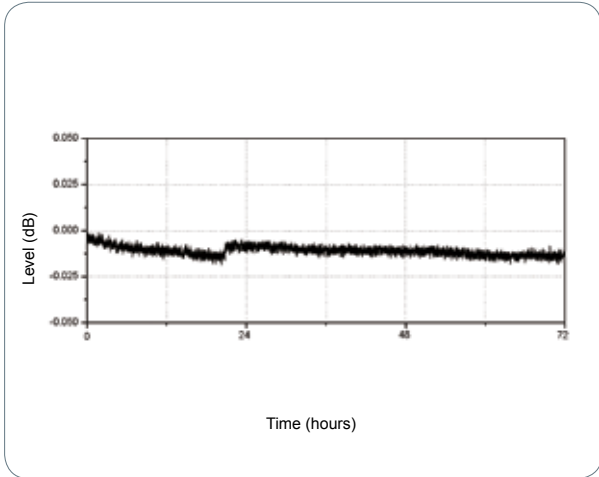

Measured +13dBm output level VS frequency

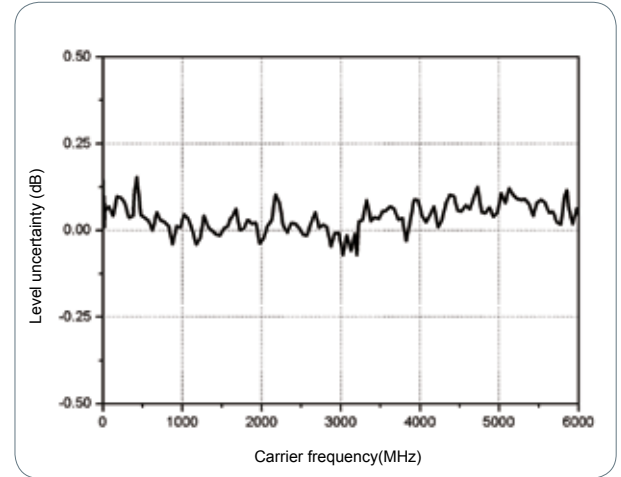

Measured 0dBm output level VS frequency

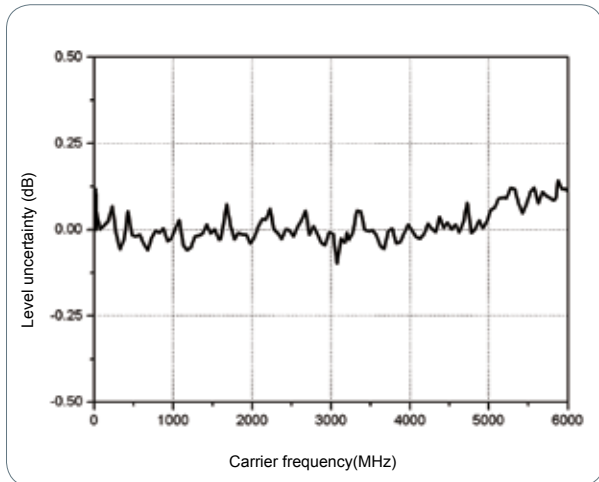

Measured -60dBm output level VS frequency

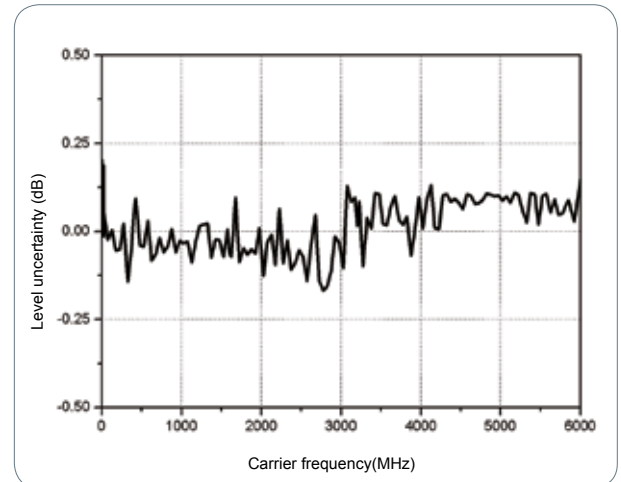

Measured -110dBm output level VS frequency

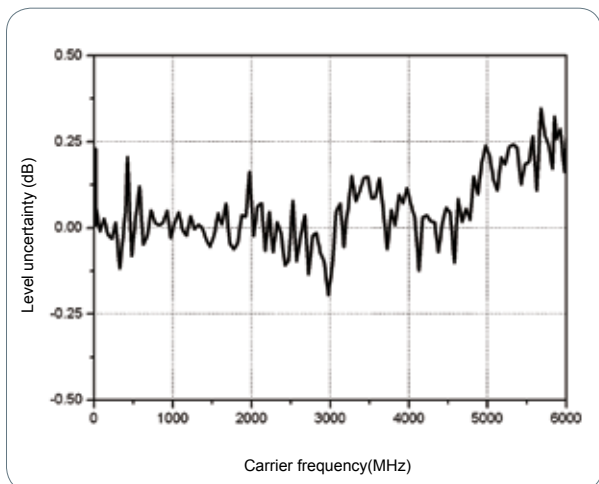

Measured -127dBm output level VS frequency

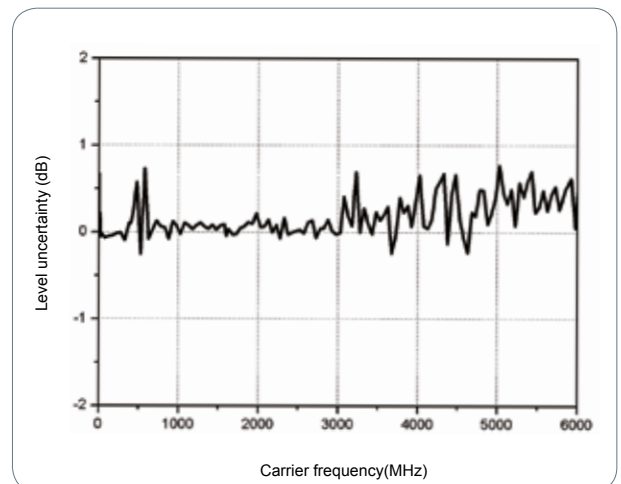

Measured -136dBm output level VS frequency

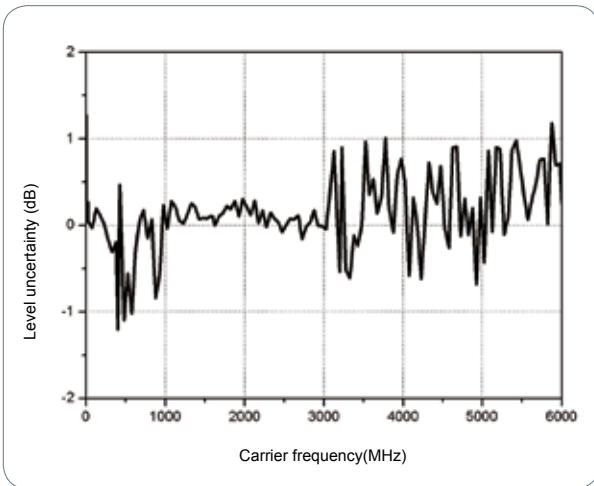

Pulse Generator Setting

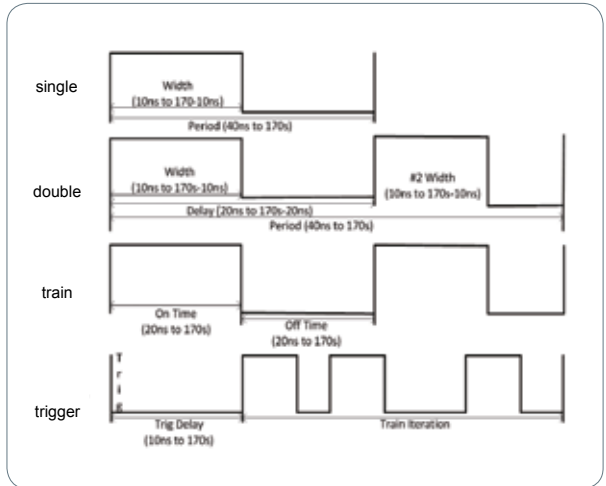

Measured external IQ bandwidth

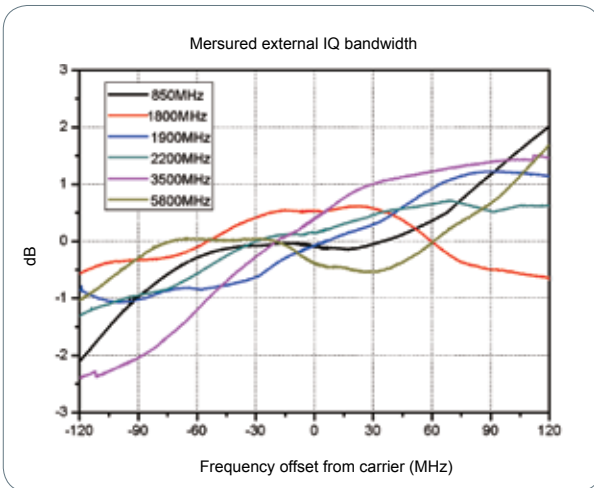

Measured internal IQ bandwidth

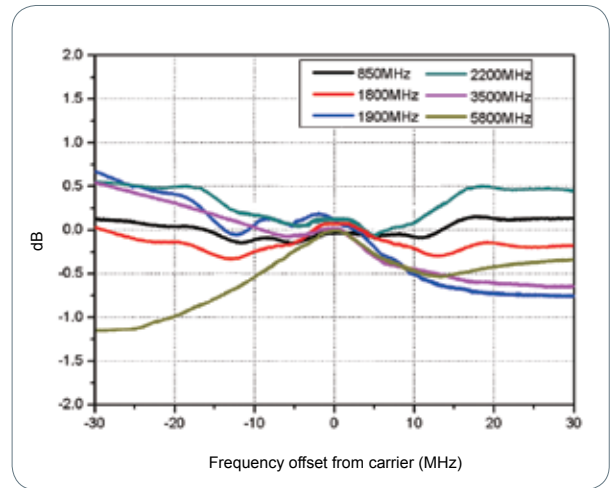

Measured carrier suppression

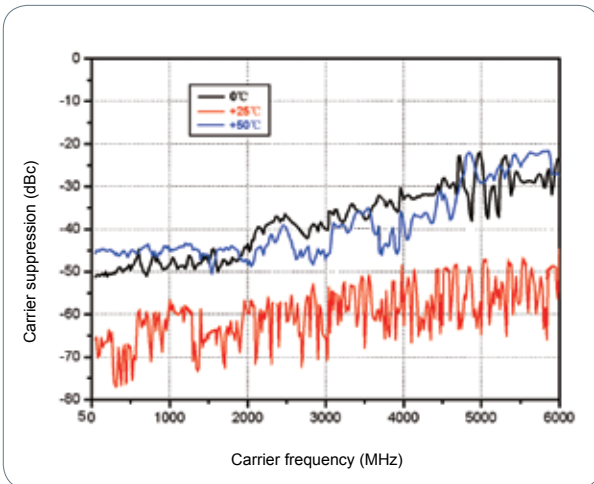

Measured suppression of image sideband

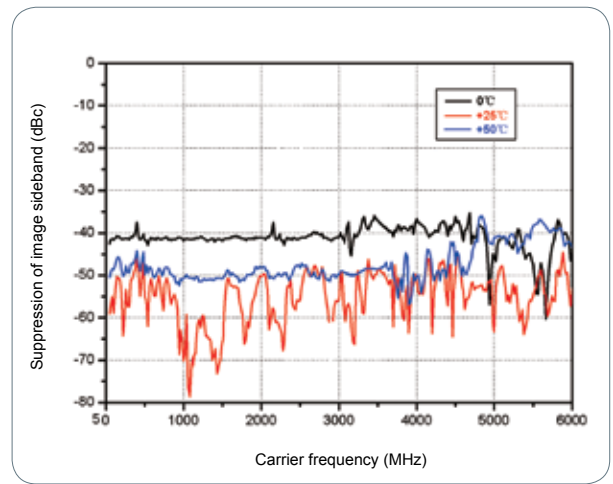

## ► Key Specifications

Model		DSG3030	DSG3060
Range	Frequency	9kHz ~ 3GHz	9kHz ~ 6GHz
	Level	-130dBm to +13dBm	
	Level Setting	-140dBm to +25dBm	
Reference clock Stability		< 0.5ppm, < 5ppb(OXCO option)	
Level uncertainty		<0.5dB typ.	
Spectral Purity	SSB phase noise	typ. <-110dBc/Hz@1GHz,20KHz Offset	
	Harmonics	<-30dBc	
	Non harmonics	typ. <-64dBc	
Sweep	Sweep Modes	Linear/Logarithmic,Step/List,Single/Continuous	
	Points	2 ~ 65535(Step) 1 ~ 6001(Linear)	
Modulation		AM,FM,PM,Pulse modulation,IQ	
AM	Depth	0% ~ 100%	
	AM depth uncertainty	<4% of setting+1%	
	Modulation frequency response	10Hz ~ 50kHz(<3dB,m<80%)	
FM	Maximum deviation	N×1MHz (nom.)	
	Setting uncertainty	<2% of setting+20Hz	
	Modulation frequency response	10Hz ~ 100kHz(<3dB)	
PM	Maximum deviation	3rad( $f \leq 23.4375\text{MHz}$ ), $N \times 5\text{rad}(f > 23.4375\text{MHz})$	
	Deviation accuracy	<1% of setting+0.1rad	
	Modulation frequency response	10Hz ~ 100kHz(<3dB)	
Pulse	On/off ratio	>80dB( $25\text{MHz} \leq f < 3\text{GHz}$ ),>70dB( $3\text{GHz} \leq f \leq 6\text{GHz}$ )	
Modulation	Rise/fall time (10%/90%)	10ns(typ.)	
	Modes	Single pulse, double pulse, pulse train(option PUG-DSG3000)	
IQ	BW	External: Baseband(I or Q): up to 120MHz; RF(I+Q): up to 240MHz; Internal: Baseband(I or Q): up to 30MHz; RF(I+Q): up to 60MHz	
	EVM	16QAM , root cosine filter ( $\alpha=0.22$ ), 4MSps $50\text{MHz} \leq f \leq 3\text{GHz}$ (level≤4dBm): ≤0.7%rms (typ.) $3\text{GHz} < f \leq 6\text{GHz}$ (level≤0dBm): ≤1.2%rms (typ.) QPSK , root cosine filter ( $\alpha=0.22$ ), 4MSps $50\text{MHz} \leq f \leq 3\text{GHz}$ (level≤4dBm): ≤0.7%rms (typ.) $3\text{GHz} < f \leq 6\text{GHz}$ (level≤0dBm): ≤1.2%rms (typ.)	
General	Interfaces	USB/LAN/GPIB Reference clock 10MHz Ref In/Out,Trigger In I/Q In/Out(Opt.),LF Out Ext Mod,Ext Pulse Signal Valid,Sweep Out	
	Display	4.3" TFT LCD,480x272	
	Size	364mm×112mm×420mm	
	Weight	6.7kg	

## ► Ordering Information

Model	Description	Order Number
	Signal Generator, 9kHz to 3GHz	DSG3030
	Signal Generator, 9kHz to 6GHz	DSG3060
Standard accessories	Quick Guide (Hard Copy)	-
	CDROM (User Guide, Programming Guide)	-
	Power Cable	-
Options	DSG IQ function PC Software	Ultra IQ Station
	Pulse Train Generator	PUG-DSG3000
	High Stable OCXO Reference Clock	OCXO-A08
	I/Q Modulation, Baseband Output	IQ-DSG3000
	Power Meter Controller	PMC-DSG3000
	Rack Mount Kit	RM-DSG3000

# DG5000 Series Function/Arbitrary Waveform Generators



## ► Features and Benefits

- 350 MHz, 250 MHz, 100 MHz, 70 MHz maximum output frequency
- 1 GSa/s sample rate, 14 bits vertical resolution
- Up to 128Mpts Editable Arbitrary Waveform
- Complete Isolation Between Channels and Support Freq/Phase Coupling
- 2+16 Mixed Signal Source (Opt.)
- Rise/Fall Time of the Pulse could be adjusted separately.
- Support Frequency Hopping and IQ Modulation
- Powerful Waveform Editing PC Software
- Connectivity: USB Host & Device, LAN, GPIB

## ► Key Specifications

Model	DG5352	DG5252	DG5102	DG5072
	DG5351	DG5251	DG5101	DG5071
Channel	2/1	2/1	2/1	2/1
Maximum Frequency	350 MHz	250 MHz	100 MHz	70 MHz
Sample Rate	1 GSa/s			
<b>Waveforms</b>				
Standard Waveforms	Sine, Square, Ramp, Pulse, Noise			
Arbitrary Waveforms	Sinc, Exponential Rise, Exponential Fall, ECG, Gauss, HaverSine, Lorentz, Dual-Tone, DC			
<b>Frequency Characteristics</b>				
Sine	1 $\mu$ Hz to 350 MHz	1 $\mu$ Hz to 250 MHz	1 $\mu$ Hz to 100 MHz	1 $\mu$ Hz to 70 MHz
Square	1 $\mu$ Hz to 120 MHz	1 $\mu$ Hz to 120 MHz	1 $\mu$ Hz to 100 MHz	1 $\mu$ Hz to 70 MHz
Ramp	1 $\mu$ Hz to 5 MHz	1 $\mu$ Hz to 5 MHz	1 $\mu$ Hz to 3 MHz	1 $\mu$ Hz to 3 MHz
Pulse	1 $\mu$ Hz to 50 MHz	1 $\mu$ Hz to 50 MHz	1 $\mu$ Hz to 50 MHz	1 $\mu$ Hz to 50 MHz
Noise	250 MHz Bandwidth			
Arb	1 $\mu$ Hz to 50 MHz	1 $\mu$ Hz to 50 MHz	1 $\mu$ Hz to 50 MHz	1 $\mu$ Hz to 50 MHz
Resolution	1 $\mu$ Hz			
Accuracy	$\pm 1$ ppm, 18 °C to 28 °C			
<b>Sine Wave Spectrum Purity</b>				
Harmonic Distortion	Typical (0 dBm) $\leq 100$ MHz: <-45dBc >100MHz: <-35dBc	Typical (0 dBm) $\leq 100$ MHz: <-45dBc >100MHz: <-35dBc	Typical (0 dBm) $\leq 100$ MHz: <-45dBc	Typical (0 dBm) $\leq$ 70MHz: <-45dBc
Total Harmonic Distortion	<0.5% (10 Hz to 20 kHz, 0 dBm)			
Spurious (non-harmonic)	Typical (0 dBm) $\leq 100$ MHz: <-50dBc >100MHz: -50dBc+6dBc/octave	Typical (0 dBm) $\leq 100$ MHz: <-50dBc >100MHz: -50dBc+6dBc/octave	Typical (0 dBm) $\leq$ 100MHz: <-50dBc	ypical (0 dBm) $\leq$ 70MHz: <-50dBc
Phase Noise	Typical (0 dBm, 10 kHz deviation) 10 MHz: <-110 dBc			
<b>Signal Characteristics</b>				
<b>Square</b>				
Rise/Fall Time	Typical Value (1Vpp) < 2.5 ns	Typical Value (1Vpp) < 2.5 ns	Typical Value (1Vpp) < 3 ns	Typical Value (1Vpp) <4 ns
Overshoot	Typical Value (1Vpp) < 5%			
Duty Cycle	$\leq 10$ MHz: 20.0% to 80.0% 10 MHz to 40 MHz: 40.0% to 60.0% > 40 MHz: 50.0% (fixed)			
Non-symmetry	1% of period + 5 ns			
Jitter (rms)	Typical Value (1Vpp) $\leq 30$ MHz: 10ppm+500 ps > 30 MHz: 500 ps			
<b>Arb</b>				
Waveform Length	Normal Mode: 2 to 16Mpts Play Mode : 2 to 128Mpts			
Vertical Resolution	14 bits			
Mode	Normal Mode, Play Mode			
Sample Rate	Normal Mode (Waveform Length is from 2 to 16Mpts): 1G Sa/s (fixed) Play Mode (Waveform Length is from 2 to 128Mpts): $\leq 1$ G Sa/s (variable)			



Output Characteristics				
Amplitude (into 50 Ω)				
Range	≤ 100 MHz: 5 mVpp to 10 Vpp ≤ 300 MHz: 5 mVpp to 5 Vpp ≤ 350 MHz: 5 mVpp to 2 Vpp	≤100MHz: 5mVpp to 10Vpp ≤250MHz: 5mVpp to 5Vpp	5mVpp to 10Vpp	5mVpp to 10Vpp
Accuracy	Typical (1 kHz Sine, 0 V Deviation, >10 mVpp, Auto) ± 1% of setting ± 1 mVpp			
Amplitude	<10MHz: ±0.1dB	10MHz: ±0.1dB	<10MHz: ±0.1dB	<10MHz: ±0.1dB
Flatness	10MHz to 60MHz: ±0.2dB	10MHz to 60MHz: ±0.2dB	10MHz to 60MHz: ±0.2dB	10MHz to 60MHz: ±0.2dB
(relative to 100 kHz, 1.25Vpp Sine wave, 50Ω)	60MHz to 100MHz: ±0.4dB 100MHz to 250MHz: ±1.0dB >250MHz: ±1.5dB	60MHz to 100MHz: ±0.4dB 100MHz to 250MHz: ±1.0dB	60MHz to 100MHz: ±0.4dB	60MHz to 70MHz: ±0.4dB
Units	Vpp, Vrms, dBm, High Level, Low Level			
Protection	Over-temperature protected, Short-circuit protected, Overload relay automatically disables main output			

FH Characteristic				
FH Bandwidth	1.5 MHz to 250 MHz	1.5 MHz to 250 MHz	1.5 MHz to 100 MHz	1.5 MHz to 70 MHz
FH Rate	1 Hop/s to 12.5M Hop/s			
Frequency Point Numbers	4096			
Sequence Length	4096			
Modulation Characteristics				
Modulation Types	AM, FM, PM, ASK, FSK, PSK, PWM, IQ			

IQ				
Carrier Waveform	Sine (max. 200 MHz)	Sine (max. 200 MHz)	Sine (max. 100 MHz)	Sine (max. 70 MHz)
Source	Internal/External			
Code Pattern	PN Sequence, 4 bits code pattern, User			
IQ Mapping	4QAM, 8QAM, 16QAM, 32QAM, 64QAM, BPSK, QPSK, OQPSK, 8PSK, 16PSK, User			
Code Rate	1 bps to 1 M bps			

Burst Characteristics				
Carrier Waveforms	Sine, Square, Ramp, Pulse, Noise, Arb (except DC)			
Carrier Frequency	1 μHz to 120 MHz	1 μHz to 120 MHz	1 μHz to 100 MHz	1 μHz to 70 MHz
Burst Count	1 to 1 000 000 or Infinite			
Start/Stop Phase	0° to 360°			
Internal Period	1 μs to 500 s			
Gated Source	External Trigger			
Trigger Source	Internal, External or Manual			
Trigger Delay	0 ns to 85 s			

## ► Ordering Information

Model	Description	Order Number
	DG5352 (350 MHz, dual-channel)	DG5352
	DG5351 (350 MHz, single channel)	DG5351
	DG5252 (250 MHz, dual-channel)	DG5252
	DG5251 (250 MHz, single channel)	DG5251
	DG5102 (100 MHz, dual-channel)	DG5102
	DG5101 (100 MHz, single channel)	DG5101
	DG5072 (70MHz, dual-channel)	DG5072
	DG5071 (70MHz, single-channel)	DG5071
Standard	Power Cord	-
Accessories	USB Cable	CB-USBA-USBB-FF-150
	BNC Cable (1 meter)	CB-BNC-BNC-MM-100
	Quick Guide (Hard Copy)	-
	Resource CD (including User's Guide and Application Software)	-
Options	SMB(F) to BNC(M) Cable (1 meter)	CB-SMB-BNC-FM-100
	Frequency Hopping Module	FH-DG5000
	Logic Signal Output Module	DG-POD-A
Optional Accessories	Power Amplifier	PA1011
	SMB(F) to SMB(F) Cable (1 meter)	CB-SMB-SMB-FF-100
	SMB(F) to BNC(F) Cable (1 meter)	CB-SMB-BNC-FF-100
	40 dB Attenuator	RA5040K
	Rack Mount Kit	RM-DG5000

# DG4000 Series Function/Arbitrary Waveform Generators



## ► Features and Benefits

- 160 MHz, 100 MHz, 60 MHz maximum output frequency
- 500MSa/s sample rate, 14 bits vertical resolution
- Dual Channel Outputs With Identical Performance
- 2ppm High-frequency Stability
- -115dBc/Hz Low Phase Noise
- Versatile Analog and Digital Modulation functions
- Built-in 150 Waveforms
- Built-in 7digits/s, 200MHz Counter
- 16th Harmonic Generation Function(Std.)
- Powerful Waveform Editing PC Software
- Connectivity: USB Host & Device, LAN
- 7 Inch LCD Display (800x480)

## ► Key Specifications

All the specifications can be guaranteed if the following two conditions are met unless where noted.

- The generator is within the calibration and has performed self-calibration.
- The generator has been working continuously for 30 minutes at specified temperature (18°C ~ 28°C).



All the specifications are guaranteed unless those marked with "typical".

Model	DG4162	DG4102	DG4062
Channel	2	2	2
Maximum Frequency	160MHz	100 MHz	60 MHz
Sample Rate	500 MSa/s		

Waveforms			
Standard waveforms	Sine, Square, Ramp, Pulse, Noise, Harmonics		
Arbitrary Waveforms	150 kinds, including Sinc, Exponential Rise, Exponential Fall, ECG, Gauss, HaverSine, Lorentz, Dual-Tone, DC, etc.		
Frequency Characteristics			
Sine	1 μHz to 160 MHz	1 μHz to 100 MHz	1 μHz to 60 MHz
Square	1 μHz to 50 MHz	1 μHz to 40 MHz	1 μHz to 25 MHz
Ramp	1 μHz to 4MHz	1 μHz to 3 MHz	1 μHz to 1 MHz
Pulse	1 μHz to 40 MHz	1 μHz to 25 MHz	1 μHz to 15 MHz
Harmonic	1 uHz to 80 MHz	1 uHz to 50 MHz	1 uHz to 30 MHz
Noise (-3dB)	120 MHz Bandwidth	80 MHz Bandwidth	60 MHz Bandwidth
Arb	1 μHz to 40 MHz	1 μHz to 25 MHz	1 μHz to 15 MHz
Resolution	1 μHz		
Accuracy	±2ppm, 18 °C to 28 °C		

Sine Wave Spectrum Purity	
Harmonic Distortion	Typical (0dBm) DC-1MHz: <-60dBc 1MHz-10MHz: <-55dBc 10MHz-100MHz: <-50dBc 100MHz-160MHz: <-40dBc
Total Harmonic Distortion	<0.1%(10Hz-20kHz,0dBm)
Spurious (non-harmonic)	Typical(0dBm) ≤10MHz <-65dBc >10MHz <-65dBc+6dB/octave
Phase Noise	Typical (0 dBm, 10 kHz deviation) 10 MHz: ≤-115 dBc/Hz

Signal Characteristics			
Square			
Rise/Fall Time	Typical (1Vpp) <8 ns	Typical (1Vpp) <10 ns	Typical (1Vpp) <12 ns
Overshoot	Typical (1Vpp) <3%		
Duty Cycle	≤10 MHz: 20.0% to 80.0% 10 MHz-40 MHz: 40.0% to 60.0% >40 MHz: 50.0% (fixed)		
Non-symmetry	1% of period + 5 ns		
Jitter (rms)	Typical,(1MHz,1Vpp,50Ω) ≤5MHz 2ppm+500 ps > 5MHz 500ps		

<b>Arb</b>	
Waveform Length	16k points
Vertical Resolution	14 bits
Sample Rate	500M Sa/s
<b>Harmonic</b>	
Harmonic Order	≤16
Harmonic Type	Even, Odd, All, User
Harmonic Amplitude	can be set for all the harmonics
Harmonic Phase	can be set for all the harmonics

<b>Output Characteristics</b>			
<b>Amplitude (into 50 Ω)</b>			
Range	≤20MHz: 1mVpp to 10Vpp ≤60MHz: 1mVpp to 5Vpp ≤120MHz: 1mVpp to 2.5Vpp ≤160MHz: 1mVpp to 1Vpp	≤20MHz: 1mVpp to 10Vpp ≤60MHz: 1mVpp to 5Vpp ≤100MHz: 1mVpp to 2.5Vpp	≤20MHz: 1mVpp to 10Vpp ≤60MHz: 1mVpp to 5Vpp
Accuracy	Typical (1kHz Sine, 0V Offset, >10mVpp, Auto) ± 1% of setting ± 2mVpp		
Amplitude Flatness (relative 1kHz, 500mVpp Sine wave, 50Ω)	Typical ≤10MHz: ±0.1dB ≤60MHz: ±0.2dB ≤100MHz: ±0.4dB ≤160MHz: ±0.8dB	Typical ≤10MHz: ±0.1dB ≤60MHz: ±0.2dB ≤100MHz: ±0.4dB	Typical ≤10MHz: ±0.1dB ≤60MHz: ±0.2dB
Units	Vpp, Vrms, dBm		
Protection	Short-circuit protection, automatically disables main output when overload relay		
<b>Modulation Characteristics</b>			
Modulation Types	AM, FM, PM, ASK, FSK, PSK, BPSK, QPSK, 3FSK, 4FSK, OSK, PWM		

<b>Burst Characteristics</b>			
Carrier Waveforms	Sine, Square, Ramp, Pulse, Noise, Arb (except DC)		
Carrier Frequency	2mHz to 100 MHz	2mHz to 100 MHz	2mHz to 60 MHz
Burst Count	1 to 1 000 000 or Infinite		
Start/Stop Phase	0° to 360°		
Internal Period	2μs to 500 s		
Gated Source	External Trigger		
Trigger Source	Internal, External or Manual		
Trigger Delay	0 ns to 85 s		

<b>Counter Specifications</b>	
Function	Frequency, Period, Positive/Negative Pulse Width, Duty Cycle
Freqcy Resolution	7 digits/second
Freqcy Range	1uHz to 200MHz

## ► Ordering Information

	Description	Order Number
Model	DG4162 (160 MHz, dual-channel)	DG4162
	DG4102 (100 MHz, dual-channel)	DG4102
	DG4062 (60 MHz, dual-channel)	DG4062
Standard Accessories	Power Cord	-
	USB Cable	CB-USBA-USBB-FF-150
	BNC Cable (1 meter)	CB-BNC-BNC-MM-100
	Quick Guide (Hard Copy)	-
Optional Accessories	Resource CD (including User's Guide and Application Software)	-
	DG4 PC Software	Ultra Station
	40 dB Attenuator	RA5040K
	Rack Mount Kit	RM-DG4000
	Soft Carrying bag	BAG-G1

# DG1000Z Series Function/Arbitrary Waveform Generators



## ► Features and Benefits

- Innovative SiFi(Signal Fidelity) Technology
- Up to 16Mpts(Opt.) Arb Waveform Memory
- Dual Identical Channel
- 200MSa/s Sample Rate
- 14bits Vertical Resolution
- 7digits/s, 200MHz Counter
- 8th Harmonic Generation Function
- $\pm 1$ ppm High-frequency Stability
- -125dBc/Hz Low Phase Noise
- Std. waveform Summing function
- Built-in 160 Waveforms
- Waveform Editing PC Software
- Connectivity:LAN(LXI Core Device 2011), USB Host&Device,USB-GPIB(Opt.)

## ► Key Specifications

Model	DG1032Z	DG1062Z
Channel	2	2
Max Frequency	30 MHz	60 MHz
Sample Rate	200 MSa/s	

Waveform		
Basic Waveform	Sine, Square, Ramp, Pulse, Noise	
Built-in Arbitrary Waveform	160 kinds, including Sinc, Exponential Rise, Exponential Fall, ECG, Gauss, HaverSine, Lorentz, Dual-Tone, DC Voltage, etc.	

Frequency Characteristics		
Sine	1 $\mu$ Hz to 30 MHz	1 $\mu$ Hz to 60MHz
Square	1 $\mu$ Hz to 15 MHz	1 $\mu$ Hz to 25 MHz
Ramp	1 $\mu$ Hz to 500kHz	1 $\mu$ Hz to 1MHz
Pulse	1 $\mu$ Hz to 15 MHz	1 $\mu$ Hz to 25 MHz
Harmonic	1uHz to 10MHz	1uHz to 20MHz
Noise (-3dB)	30 MHz bandwidth	60 MHz bandwidth
Arbitrary Waveform	1 $\mu$ Hz to 10 MHz	1 $\mu$ Hz to 20 MHz
Resolution	1 $\mu$ Hz	
Accuracy	$\pm 1$ ppm of the setting value, 18°C to 28°C	

Sine Wave Spectrum Purity		
Harmonic Distortion	Typical (0 dBm)	
	DC-10 MHz (included):	<-65 dBc
	10 MHz to 30 MHz (included):	<-55 dBc
	30 MHz to 60 MHz (included):	<-50 dBc
Total Harmonic Distortion	<0.075% (10 Hz to 20 kHz, 0 dBm)	
Spurious (non-harmonic)	Typical (0 dBm)	
	$\leq 10$ MHz	<-70 dBc
	>10 MHz	<-70 dBc + 6 dB/octave
Phase Noise	Typical (0 dBm, 10 kHz offset)	
	10 MHz:	<-125 dBc/Hz

Signal Characteristics		
Square		
Rise/Fall Time	Typical (1 Vpp) <10ns	
Overshoot	Typical (100 kHz, 1 Vpp) $\leq 5\%$	
Duty Cycle	0.01% to 99.99% (limited by the current frequency setting)	
Non-symmetry	1% of the period + 5 ns	
Jitter (rms)	Typical (1 Vpp)	
	$\leq 5$ MHz	2 ppm + 200 ps
	> 5 MHz	200 ps
Ramp		
Linearity	$\leq 1\%$ of peak output (typical, 1 kHz, 1 VPP, 100% symmetry)	



Symmetry	0% to 100%
Pulse	
Pulse Width	≥16 ns (limited by the current frequency setting)
Rising/Falling Edge	≥10 ns (limited by the current frequency setting and pulse width setting)
Overshoot	Typical (1 Vpp) ≤5%
Jitter (rms)	Typical (1 Vpp) ≤5 MHz 2 ppm + 200 ps > 5 MHz 200 ps
Arbitrary Waveform	
Waveform Length	8 pts to 2 Mpts (16 Mpts optional)
Vertical Resolution	14 bits
Sample Rate	200MSa/s
Min Rise/Fall Time	Typical (1 Vpp) <5 ns
Jitter (rms)	Typical (1 Vpp) ≤5 MHz 2 ppm + 200 ps > 5 MHz 200 ps
Editing Mode	Point Edit, Block Edit, Insert Built-in Waveform
Harmonic Output	
Harmonic Order	≤8
Harmonic Type	Even Harmonic, Odd harmonic, Order Harmonic, User
Harmonic Amplitude	The amplitude of each order of harmonic can be set
Harmonic Phase	The phase of each order of harmonic can be set
Output Characteristics	
Amplitude (into 50 Ω)	
Range	≤10 MHz: 2.5 mVpp to 10 Vpp ≤30 MHz: 2.5 mVpp to 5.0 Vpp ≤60 MHz: 2.5 mVpp to 2.5 Vpp
Accuracy	Typical (1 kHz sine, 0 V offset, >10 mVpp, auto) ±1% of the setting value ±1 mV
Flatness	Typical (sine, 2.5 Vpp) ≤10 MHz ±0.1 dB ≤60 MHz ±0.2 dB
Unit	Vpp, Vrms, dBm
Resolution	0.1mVpp or 4 digits
Offset (into 50 Ω)	
Range (Peak ac+dc)	±5 V
Accuracy	1% of the setting value + 5 mV + 0.5% of the amplitude
Waveform Output	
Output Impedance	50 Ω (typical)
Protection	Short-circuit protection, automatically disable the waveform output when overload occurs
Modulation Characteristics	
Modulation Type	AM, FM, PM, ASK, FSK, PSK, PWM
Frequency Counter	
Function	Frequency, Period, Positive/Negative Pulse Width, Duty Cycle
Frequency Resolution	7 digits/second (Gate Time = 1s)
Frequency Range	1 μHz to 200 MHz

## ► Ordering Information

Model	Description	Order Number
	DG1032Z (30MHz, Dual-channel)	DG1032Z
	DG1062Z (60MHz, Dual-channel)	DG1062Z
Standard Accessories	Power Cord	-
	USB Cable	CB-USBA-USBB-FF-150
	BNC Cable	CB-BNC-BNC-MM-100
	Quick Guide	-
	Resource CD (including User's Guide and etc.)	-
Options	16Mpts Memory for Arb	Arb16M-DG1000Z
	Rack Mount Kit (for single instrument)	RM-1-DG1000Z
	Rack Mount Kit (for dual instruments)	RM-2-DG1000Z
	40dB Attenuator	RA5040K
	10W Power Amplifier	PA1011
	USB-GPIB Converter	USB-GPIB

# DG1000 Series Function/Arbitrary Waveform Generators



## ► Features and Benefits

- Max. Output frequency 25 MHz
- Dual Channel Output
- 100MSa/s Sample Rate
- 14bits Vertical Resolution
- Built-in 6digits/s, 200MHz Counter
- Built-in 48 Waveforms
- Powerful Waveform Editing PC Software
- Connectivity: USB Device and USB Host

## ► Models and Key Specifications

Models	DG1022	DG1022A
Frequency Characteristics		
Sine	1μHz ~ 20MHz	1μHz ~ 25MHz
Square	1μHz ~ 5MHz	1μHz ~ 5MHz
Pulse	500μHz ~ 3MHz	500μHz ~ 5MHz
Ramp	1μHz ~ 150kHz	1μHz ~ 500kHz
Noise(-3dB)	5MHz BW(-3dB)	5MHz BW(-3dB)
Arb	1μHz ~ 5MHz	1μHz ~ 5MHz
Resolution	1 μHz	

Sine Wave Spectrum Purity				
Harmonic Distortion	Ch1		Ch2	
	≤1VPP	>1VPP	≤1VPP	>1VPP
DC-1MHz	-45dBc	-45dBc	-45dBc	-45dBc
1MHz-5MHz	-45dBc	-40dBc	-45dBc	-40dBc
5MHz-20MHz	-45dBc	-35dBc	-45dBc	-35dBc
Total Harmonic Distortion	DC ~ 20 kHz, 1VPP <0.2%			
Spurious (non-harmonic)	DC ~ 1 MHz < -70 dBc			
	1 MHz ~ 10 MHz < -70 dBc + 6 dB/ octave			
Phase Noise	10kHz Offset, -108 dBc / Hz, typ.			

Signal Characteristics	
Rise/Fall Time	< 20 ns(10% ~ 90%, typ, 1kHz, 1 VPP)
Overshoot	< 5%(Typ., 1kHz, 1 VPP)
Duty Cycle	1μHz~ 3MHz
	3MHz(Excluding) ~ 4MHz
	4MHz(Excluding) ~ 5MHz
Non-symmetry (@50% Duty cycle)	1% of period + 20ns(typ., 1kHz, 1 VPP)

Output Characteristics	DG1022		DG1022A	
Amplitude(50Ω)	Ch1	Ch2	Ch1	Ch2
		2 mVPP ~ 10 VPP	2 mVPP ~ 3 VPP	≤20MHz: 2 mVPP ~ 10 VPP; >20MHz:2 mVPP ~ 5 VPP;

Waveform Output	Ch1	Ch2
Impedance	50Ω typ.	50Ω typ.
Protection <sup>[2]</sup>	Short-circuit protection; auto disable if over loading	Short-circuit protection
Modulation Mode	AM,FM,PM,FSK-internal or external	

Counter Specification	
Function	Frequency, period, positive/negative Pulse width, Duty cycle
Frequency range	Single channel: 100 mHz ~ 200 MHz
Frequency resolution	6 Digits/Second

# DM3068 6½ Digital Multimeter



## ► Features and Benefits

- 2,200,000 Counts of Resolution
- 0.0035% DC Voltage Accuracy
- Up to 10krdgs/s Measurement Speed
- Max. 10A Current Measurement Range
- Dual Measurements Display
- Real-time Trend and Histogram display
- Display Functions
- User Definable Any-sensor function with UltraSensor PC sw
- Command compatible with main stream DMMs
- Connectivity: USB Host&Device, RS-232, GPIB, LAN (LXI-C)

## ► Features and Benefits

Real 6½ digits readings resolution

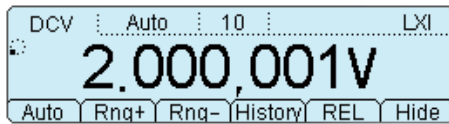

Easy to measure AC signal with double display

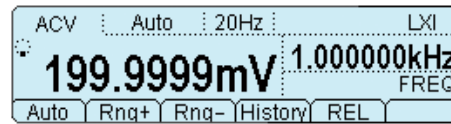

Standard Capacitor measurement function

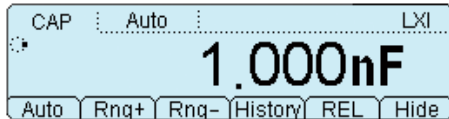

"Any sensor" function

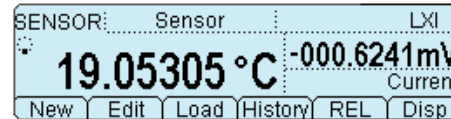

Support multiple commands

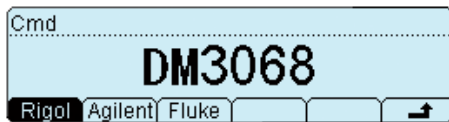

File management (support for U-disc and local storage)

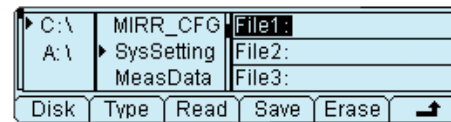

Math function

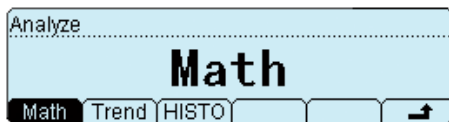

Statistic function



Histogram display

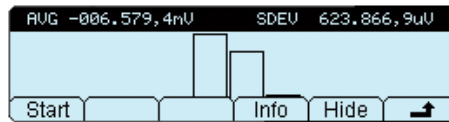

Trend display

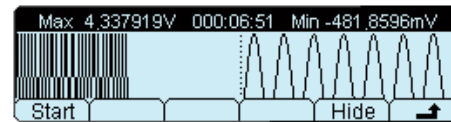

Abundant basic measurement functions:

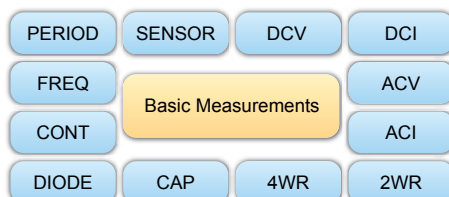

- DCV Range: -1000 V ~ 1000 V
- DCI Range: -10 A ~ 10 A
- ACV Range(True-RMS): 0 V ~ 750 V
- ACI Range(True-RMS): 0 A ~ 10 A
- R Range: 0 Ω ~ 100 MΩ
- C Range: 0 F ~ 100 mF
- F Range: 3 Hz ~ 1 MHz

## Real Time statistic analysis functions

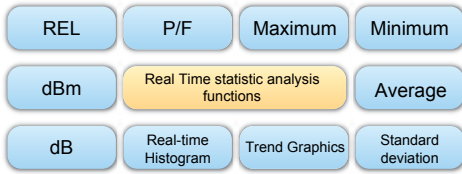

## LXI Certificate and Web remote control



## ► Key Specifications

### DC Characteristics

Accuracy Specifications:  $\pm$  (% of reading + % of range)<sup>[1]</sup>

Function	Range <sup>[2]</sup>	Test Current or Burden Voltage	24 Hour <sup>[3]</sup> $T_{CAL} \text{ } ^\circ\text{C} \pm 1 \text{ } ^\circ\text{C}$	90 Day $T_{CAL} \text{ } ^\circ\text{C} \pm 5 \text{ } ^\circ\text{C}$	1 Year $T_{CAL} \text{ } ^\circ\text{C} \pm 5 \text{ } ^\circ\text{C}$	Temperature Coefficient 0 °C to ( $T_{CAL} \text{ } ^\circ\text{C} - 5 \text{ } ^\circ\text{C}$ ) ( $T_{CAL} \text{ } ^\circ\text{C} + 5 \text{ } ^\circ\text{C}$ ) to 50 °C
DC Voltage	200.0000mV		0.0020 + 0.0020	0.0030 + 0.0025	0.0040 + 0.0025	0.0005 + 0.0005
	2.000000V		0.0015 + 0.0005	0.0020 + 0.0006	0.0035 + 0.0006	0.0005 + 0.0001
	20.00000V		0.0020 + 0.0004	0.0030 + 0.0005	0.0040 + 0.0005	0.0005 + 0.0001
	200.0000V		0.0020 + 0.0006	0.0040 + 0.0006	0.0050 + 0.0006	0.0005 + 0.0001
	1000.000V <sup>[4]</sup>		0.0020 + 0.0006	0.0040 + 0.0010	0.0055 + 0.0010	0.0005 + 0.0001
DC Current	200.0000uA	<0.03V	0.010 + 0.012	0.040 + 0.015	0.050 + 0.015	0.0020 + 0.0030
	2.000000mA	<0.25V	0.007 + 0.003	0.030 + 0.003	0.050 + 0.003	0.0020 + 0.0005
	20.00000mA	<0.07V	0.007 + 0.012	0.030 + 0.015	0.050 + 0.015	0.0020 + 0.0020
	200.0000mA	<0.7V	0.010 + 0.002	0.030 + 0.003	0.050 + 0.003	0.0020 + 0.0005
	2.000000A	<0.12V	0.050 + 0.020	0.080 + 0.020	0.100 + 0.020	0.0050 + 0.0010
Resistance <sup>[6]</sup>	10.00000A <sup>[5]</sup>	<0.6V	0.100 + 0.010	0.120 + 0.010	0.150 + 0.010	0.0050 + 0.0020
	200.0000Ω	1mA	0.0030 + 0.0030	0.008 + 0.004	0.010 + 0.004	0.0006 + 0.0005
	2.000000kΩ	1mA	0.0020 + 0.0005	0.008 + 0.001	0.010 + 0.001	0.0006 + 0.0001
	20.00000kΩ	100uA	0.0020 + 0.0005	0.008 + 0.001	0.010 + 0.001	0.0006 + 0.0001
	200.0000kΩ	10uA	0.0020 + 0.0005	0.008 + 0.001	0.010 + 0.001	0.0006 + 0.0001
Diode Test	1.000000MΩ	2uA	0.002 + 0.001	0.010 + 0.001	0.012 + 0.001	0.0010 + 0.0002
	10.00000MΩ	200nA	0.015 + 0.001	0.030 + 0.001	0.040 + 0.001	0.0030 + 0.0004
	100.0000MΩ	200nA    10MΩ	0.300 + 0.010	0.800 + 0.010	0.800 + 0.010	0.1500 + 0.0002
Continuity Test	2.0000V <sup>[7]</sup>	1mA	0.002 + 0.010	0.008 + 0.020	0.010 + 0.020	0.0010 + 0.0020
	2000.0Ω	1mA	0.002 + 0.010	0.008 + 0.020	0.010 + 0.020	0.0010 + 0.0020

[1] Specifications are for 90-minute warm-up and 100NPLC integration time. For integration time <100NPLC, add the appropriate "RMS Noise Adder" listed in the following table.

[2] 10% overrange on all ranges except DCV 1000V and DCI 10A ranges.

[3] Relative to calibration standards.

[4] For each additional volt over  $\pm 500$  V, add 0.03mV error.

[5] For continuous current > 7A DC or 7A AC RMS, 30 seconds ON and 30 seconds OFF.

[6] Specifications are for 4-wire resistance measurement or 2-wire resistance measurement using REL operation. Without REL operation, add 0.2  $\Omega$  additional error in 2-wire resistance measurement.

[7] Accuracy specifications for the voltage measured at the input terminal only. 1 mA test current is typical. Variation in the current source will create some variation in the voltage drop across a diode junction.

### AC Characteristics

Accuracy Specifications:  $\pm$ (% of reading + % of range)<sup>[1]</sup>

Function	Range <sup>[2]</sup>	Frequency Range	24 Hour <sup>[3]</sup> $T_{CAL} \text{ } ^\circ\text{C} \pm 1 \text{ } ^\circ\text{C}$	90 Day $T_{CAL} \text{ } ^\circ\text{C} \pm 5 \text{ } ^\circ\text{C}$	1 Year $T_{CAL} \text{ } ^\circ\text{C} \pm 5 \text{ } ^\circ\text{C}$	Temperature Coefficient 0 °C to ( $T_{CAL} \text{ } ^\circ\text{C} - 5 \text{ } ^\circ\text{C}$ ) ( $T_{CAL} \text{ } ^\circ\text{C} + 5 \text{ } ^\circ\text{C}$ ) to 50 °C
True RMS AC Voltage <sup>[4]</sup>	200.0000 mV	3Hz - 5Hz	1.00 + 0.03	1.00 + 0.04	1.00 + 0.04	0.100 + 0.004
		5Hz - 10Hz	0.35 + 0.03	0.35 + 0.04	0.35 + 0.04	0.035 + 0.004
		10Hz - 20kHz	0.04 + 0.03	0.05 + 0.04	0.06 + 0.04	0.005 + 0.004
		20kHz - 50kHz	0.10 + 0.05	0.11 + 0.05	0.12 + 0.05	0.011 + 0.005
		50kHz - 100kHz	0.55 + 0.08	0.60 + 0.08	0.60 + 0.08	0.060 + 0.008
	2.000000 V	100kHz - 300kHz	4.00 + 0.50	4.00 + 0.50	4.00 + 0.50	0.20 + 0.02
		3Hz - 5Hz	1.00 + 0.02	1.00 + 0.03	1.00 + 0.03	0.100 + 0.003
		5Hz - 10 Hz	0.35 + 0.02	0.35 + 0.03	0.35 + 0.03	0.035 + 0.003
		10Hz - 20kHz	0.04 + 0.02	0.05 + 0.03	0.06 + 0.03	0.005 + 0.003
		20kHz - 50kHz	0.10 + 0.04	0.11 + 0.05	0.12 + 0.05	0.011 + 0.005
20.00000 V	50kHz - 100kHz	0.55 + 0.08	0.60 + 0.08	0.60 + 0.08	0.060 + 0.008	
	100kHz - 300kHz	4.00 + 0.50	4.00 + 0.50	4.00 + 0.50	0.20 + 0.02	
	3Hz - 5Hz	1.00 + 0.03	1.00 + 0.04	1.00 + 0.04	0.100 + 0.004	
	5Hz - 10Hz	0.35 + 0.03	0.35 + 0.04	0.35 + 0.04	0.035 + 0.004	
	10Hz - 20kHz	0.04 + 0.04	0.07 + 0.04	0.08 + 0.04	0.008 + 0.004	
		20kHz - 50kHz	0.10 + 0.05	0.12 + 0.05	0.15 + 0.05	0.012 + 0.005

		50kHz - 100kHz	0.55 + 0.08	0.60 + 0.08	0.60 + 0.08	0.060 + 0.008
		100kHz - 300kHz	4.00 + 0.50	4.00 + 0.50	4.00 + 0.50	0.20 + 0.02
	200.0000 V	3Hz - 5Hz	1.00 + 0.02	1.00 + 0.03	1.00 + 0.03	0.100 + 0.003
		5Hz - 10Hz	0.35 + 0.02	0.35 + 0.03	0.35 + 0.03	0.035 + 0.003
		10Hz - 20kHz	0.04 + 0.02	0.07 + 0.03	0.08 + 0.03	0.008 + 0.003
		20kHz - 50kHz	0.10 + 0.04	0.12 + 0.05	0.15 + 0.05	0.012 + 0.005
		50kHz - 100kHz	0.55 + 0.08	0.60 + 0.08	0.60 + 0.08	0.060 + 0.008
		100kHz - 300kHz	4.0 + 0.50	4.0 + 0.50	4.0 + 0.50	0.20 + 0.02
	750.000 V <sup>[5]</sup>	3Hz - 5Hz	1.00 + 0.02	1.00 + 0.03	1.00 + 0.03	0.100 + 0.003
		5Hz - 10Hz	0.35 + 0.02	0.35 + 0.03	0.35 + 0.03	0.035 + 0.003
		10Hz - 20kHz	0.04 + 0.02	0.07 + 0.03	0.08 + 0.03	0.008 + 0.003
		20kHz - 50kHz	0.10 + 0.04	0.12 + 0.05	0.15 + 0.05	0.012 + 0.005
		50kHz - 100kHz	0.55 + 0.08	0.60 + 0.08	0.60 + 0.08	0.060 + 0.008
		100kHz - 300kHz	4.0 + 0.50	4.0 + 0.50	4.0 + 0.50	0.20 + 0.02
True RMS AC Current <sup>[8]</sup>	200.0000 uA	3Hz - 5Hz	1.10 + 0.06	1.10 + 0.06	1.10 + 0.06	0.200 + 0.006
		5Hz-10Hz	0.35 + 0.06	0.35 + 0.06	0.35 + 0.06	0.100 + 0.006
		10Hz-5kHz	0.15 + 0.06	0.15 + 0.06	0.15 + 0.06	0.015 + 0.006
		5kHz-10kHz	0.35 + 0.70	0.35 + 0.70	0.35 + 0.70	0.030 + 0.006
	2.000000 mA	3Hz - 5Hz	1.00 + 0.04	1.00 + 0.04	1.00 + 0.04	0.100 + 0.006
		5Hz - 10Hz	0.30 + 0.04	0.30 + 0.04	0.30 + 0.04	0.035 + 0.006
		10Hz - 5kHz	0.12 + 0.04	0.12 + 0.04	0.12 + 0.04	0.015 + 0.006
		5kHz - 10kHz	0.20 + 0.25	0.20 + 0.25	0.20 + 0.25	0.030 + 0.006
	20.00000 mA	3Hz - 5Hz	1.10 + 0.06	1.10 + 0.06	1.10 + 0.06	0.200 + 0.006
		5Hz - 10Hz	0.35 + 0.06	0.35 + 0.06	0.35 + 0.06	0.100 + 0.006
		10Hz - 5kHz	0.15 + 0.06	0.15 + 0.06	0.15 + 0.06	0.015 + 0.006
		5kHz - 10kHz	0.35 + 0.70	0.35 + 0.70	0.35 + 0.70	0.030 + 0.006
	200.0000 mA	3Hz - 5Hz	1.00 + 0.04	1.00 + 0.04	1.00 + 0.04	0.100 + 0.006
		5Hz - 10Hz	0.30 + 0.04	0.30 + 0.04	0.30 + 0.04	0.035 + 0.006
		10Hz - 5kHz	0.10 + 0.04	0.10 + 0.04	0.10 + 0.04	0.015 + 0.006
		5kHz - 10kHz	0.20 + 0.25	0.20 + 0.25	0.20 + 0.25	0.030 + 0.006
	2.000000 A	3Hz - 5Hz	1.10 + 0.06	1.10 + 0.06	1.10 + 0.06	0.100 + 0.006
		5Hz - 10Hz	0.35 + 0.06	0.35 + 0.06	0.35 + 0.06	0.035 + 0.006
		10Hz - 5kHz	0.15 + 0.06	0.15 + 0.06	0.15 + 0.06	0.015 + 0.006
		5kHz - 10kHz	0.35 + 0.70	0.35 + 0.70	0.35 + 0.70	0.030 + 0.006
	10.00000 A <sup>[6]</sup>	3Hz - 5Hz	1.10 + 0.08	1.10 + 0.10	1.10 + 0.10	0.100 + 0.008
		5Hz - 10Hz	0.35 + 0.08	0.35 + 0.10	0.35 + 0.10	0.035 + 0.008
		10Hz - 5kHz	0.15 + 0.08	0.15 + 0.10	0.15 + 0.10	0.015 + 0.008

#### Additional Low Frequency Errors (% of reading)

#### Additional Crest Factor Errors (non-sinewave)<sup>[7]</sup>

Frequency	AC Filter			Crest Factor	Error (% of reading)
	Slow	Medium	Fast		
10Hz - 20Hz	0	0.74	--	1 - 2	0.05
20Hz - 40Hz	0	0.22	--	2 - 3	0.2
40Hz - 100Hz	0	0.06	0.73	3 - 4	0.4
100Hz - 200Hz	0	0.01	0.22	4 - 5	0.5
200Hz - 1kHz	0	0	0.18		
>1kHz	0	0	0		

[1] Specifications are for 90-minute warm-up, slow ac filter and sinewave input.

[2] 10% overrange on all ranges except ACV 750 V and ACI 10 A ranges.

[3] Relative to calibration standards.

[4] Specifications are for sinewave input >5% of range. For inputs within 1% and 5% of range and <50 kHz, add 0.1% of range additional error. For 50kHz to 100kHz, add 0.13% of range additional error.

[5] ACV 750 range limited to 8x10<sup>7</sup> Volt-Hz. For input over 300V rms, add 0.7mV error for each additional volt.

[6] For continuous current > DC 7A or AC RMS 7A, 30 seconds ON and 30 seconds OFF.

[7] For frequency below 100 Hz, the specification of slow filter is only for sinewave input.

[8] Specifications are for sinewave input >5% of range. For inputs within 1% to 5% of range, add 0.1% of range additional error. Specifications are typical values for 200uA and 2mA, 2A and 10A ranges when frequency >1kHz.

## ► Ordering Information

	Description	Order Number
Model	DM3068:6½ digits	
Standard Accessories	Power Cord conforming to the standard of the country USB Cable	CB-USBA-USBB-FF-150
	Two Test Leads (black and red)	LD-DM
	Two Alligator Clips (black and red)	ALLIGATORCLIP-DMM
	Quick Guide	
	Four Spare Fuses	
	Resource CD (User's Guide and Application Software)	
Optional Accessories	Rack Mount Kit	RM-DM3000
	Kelvin Test Clips	KELVINTESTCLIP-DMM

NOTE: All the standard or optional accessories can be ordered from you local RIGOL Office.



# DM3058/DM3058E 5½ Digital Multimeter



## ► Features and Benefits

- 240,000 Counts of Resolution
- 0.015% DC Voltage Accuracy
- Up to 123krdgs/s Measurement Speed
- Max. 10A Current Measurement Range
- Dual Measurements Display
- Real-time Trend and Histogram display
- User Definable Any-sensor function with UltraSensor PC sw
- Ultra View PC software(Optional)
- Command compatible with main stream DMMs
- Support Web remote control
- Connectivity: USB Host&Device,RS-232,GPIB(DM3058),LAN(DM3058)

## ► Key Specifications

### DC Characteristics

Accuracy Specifications:  $\pm$  (% of reading + % of range)<sup>[1]</sup>

Function	Range <sup>[2]</sup>	Test Current or Burden Voltage	1Year 23°C $\pm$ 5°C	T Temperature Coefficient 0°C-18°C 28°C-50°C
DC Voltage	200.000 mV		0.015 + 0.004	0.0015 + 0.0005
	2.00000 V		0.015 + 0.003	0.0010 + 0.0005
	20.0000 V		0.015 + 0.004	0.0020 + 0.0005
	200.000 V		0.015 + 0.003	0.0015 + 0.0005
	1000.00 V[4]		0.015 + 0.003	0.0015 + 0.0005
DC Current	200.000 $\mu$ A	<8 mV	0.055 + 0.005	0.003 + 0.001
	2.00000 mA	<80 mV	0.055 + 0.005	0.002 + 0.001
	20.0000 mA	<0.05 V	0.095 + 0.020	0.008 + 0.001
	200.000 mA	<0.5 V	0.070 + 0.008	0.005 + 0.001
	2.00000 A	<0.1 V	0.170 + 0.020	0.013 + 0.001
	10.0000 A[5]	<0.3 V	0.250 + 0.010	0.008 + 0.001
Resistance <sup>[4]</sup>	200.000 $\Omega$	1 mA	0.030 + 0.005	0.0030 + 0.0006
	2.00000 k $\Omega$	1 mA	0.020 + 0.003	0.0030 + 0.0005
	20.0000 k $\Omega$	100 $\mu$ A	0.020 + 0.003	0.0030 + 0.0005
	200.000 k $\Omega$	10 $\mu$ A	0.020 + 0.003	0.0030 + 0.0005
	2.00000 M $\Omega$	1 $\mu$ A	0.040 + 0.004	0.0040 + 0.0005
	10.0000 M $\Omega$	200 nA	0.250 + 0.003	0.0100 + 0.0005
Diode Test	2.0000 V[6]	1 mA	1.75 + 0.004	0.2000 + 0.0005
Continuity Test	2000 $\Omega$	1 mA	0.05 + 0.01	0.0050 + 0.0005

#### Remarks:

[1] Specifications are for 0.5 hour warm-up, "Slow" measure and calibration temperature 18°C - 28°C.

[2] 20% over range on all ranges except for DCV 1000 V, ACV 750 V, DCI 10 A and ACI 10 A.

[3] Specifications are for 4-wire measure or 2-wire measure under "REF" operation.  $\pm$  0.2  $\Omega$  of extra errors will be generated if perform 2-wire measure without "REF" operation.

[4] Plus 0.02 mV of error per 1 V after the first  $\pm$ 500 VDC.

[5] 30 seconds OFF after 30 seconds ON is recommend for the continuous current that higher than DC 7 A or AC RMS 7 A.

Accuracy specifications are only for voltage measuring at input terminal. The typical value of current under measure is 1 mA. Voltage drop at the diode junction may vary with current supply.

### AC Characteristics

Accuracy Specifications:  $\pm$ (% of reading + % of range)<sup>[1]</sup>

Function	Range <sup>[2]</sup>	Frequency Range	1 Year 23°C $\pm$ 5°C	Temperature Coefficient 0°C-18°C 28°C-50°C	
True RMS AC Voltage <sup>[3]</sup>	200.000 mV	20 Hz – 45 Hz	1.5 + 0.10	0.01 + 0.005	
		45 Hz – 20 kHz	0.2 + 0.05	0.01 + 0.005	
		20 kHz – 50 kHz	1.0 + 0.05	0.01 + 0.005	
		50 kHz – 100 kHz	3.0 + 0.05	0.05 + 0.010	
	2.00000 V	20 Hz – 45 Hz	1.5 + 0.10	0.01 + 0.005	0.01 + 0.005
		45 Hz – 20 kHz	0.2 + 0.05	0.01 + 0.005	0.01 + 0.005
		20 kHz – 50 kHz	1.0 + 0.05	0.01 + 0.005	0.01 + 0.005
		50 kHz – 100 kHz	3.0 + 0.05	0.05 + 0.010	0.05 + 0.010
	20.0000 V	20 Hz – 45 Hz	1.5 + 0.10	0.01 + 0.005	0.01 + 0.005
		45 Hz – 20 kHz	0.2 + 0.05	0.01 + 0.005	0.01 + 0.005
		20 kHz – 50 kHz	1.0 + 0.05	0.01 + 0.005	0.01 + 0.005
		50 kHz – 100 kHz	3.0 + 0.05	0.05 + 0.010	0.05 + 0.010
200.000 V	20 Hz – 45 Hz	1.5 + 0.10	0.01 + 0.005	0.01 + 0.005	
	45 Hz – 20 kHz	0.2 + 0.05	0.01 + 0.005	0.01 + 0.005	
	20 Hz – 45 Hz	1.5 + 0.10	0.01 + 0.005	0.01 + 0.005	

		20 kHz – 50 kHz	0.01 + 0.005	0.01 + 0.005
		50 kHz – 100 kHz	0.05 + 0.010	0.05 + 0.010
	750.000 V	20 Hz – 45 Hz	0.01 + 0.005	0.01 + 0.005
		45 Hz – 20 kHz	0.01 + 0.005	0.01 + 0.005
		20 kHz – 50 kHz	0.01 + 0.005	0.01 + 0.005
		50 kHz – 100 kHz	0.05 + 0.010	0.05 + 0.010
True RMS AC Voltage <sup>[5]</sup>	20.0000 mA	20Hz – 45 Hz	0.015 + 0.015	0.015 + 0.015
		45 Hz - 2 kHz	0.015 + 0.006	0.015 + 0.006
		2 kHz - 10 kHz	0.015 + 0.006	0.015 + 0.006
	200.000 mA	20 Hz - 45 Hz	0.015 + 0.005	0.015 + 0.005
		45 Hz – 2 kHz	0.015 + 0.005	0.015 + 0.005
		2 kHz - 10 kHz	0.015 + 0.005	0.015 + 0.005
	2.00000 A	20 Hz – 45 Hz	0.015 + 0.005	0.015 + 0.005
		45 Hz - 2 kHz	0.015 + 0.005	0.015 + 0.005
		2 kHz – 10 kHz	0.015 + 0.005	0.015 + 0.005
	10.0000 A <sup>[5]</sup>	20 Hz – 45 Hz	0.015 + 0.005	0.015 + 0.005
		45 Hz - 2 kHz	0.015 + 0.005	0.015 + 0.005
		2 kHz – 5 kHz	0.015 + 0.005	0.015 + 0.005

Additional wave crest factor error (not Sine) <sup>[6]</sup>	
Wave crest coefficient	Error (% range)
1 - 2	0.05
2 - 3	0.2

**Remarks:**

- [1] Specifications are for 0.5 hour warm-up, "Slow" measure and calibration temperature 18°C - 28°C.
- [2] 20% over range on all ranges except for DCV 1000 V, ACV 750 V, DCI 10 A and ACI 10 A.
- [3] Specifications are for amplitude of sine wave input >5% of range. 750 V range limited to 8x107 Volt-Hz. For inputs from 1% to 5% of range and <50 kHz, add 0.1% of range extra error. For 50 kHz to 100 kHz, add 0.13%.

- [4] Specifications are for sine wave input >5% of range. 0.1% errors will be added when the range of input sine wave is 1% ~ 5%.
- [5] 30 seconds OFF after 30 seconds ON is recommend for the continuous current that higher than DC 7 A or AC RMS 7 A.
- [6] For frequency<100 Hz.

► **key features**



Pass/Fail Test



Dual Display

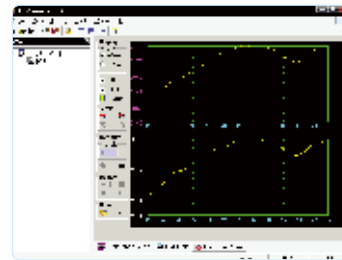

UltraSensor Software

► **Ordering Information**

	Description	Order Number
Model	DM3058:5½ digits	DM3058
	DM3058E:5½ digits,without GPIB,LAN	DM3058E
Standard	Power Cord conforming to the standard of the country	
Accessories	USB Cable	CB-USBA-USBB-FF-150
	Two Test Leads (black and red)	LD-DM
	Two Alligator Clips (black and red)	ALLIGATORCLIP-DMM
	Quick Guide	
	Four Spare Fuses	
	Resource CD (User's Guide and Application Software)	
Optional	Rack Mount Kit	RM-DM3000
Accessories	Kelvin Test Clips	KELVINTESTCLIP-DMM
	UltraView PC control and data acquisition Software	UltraView

# M300 Series Data Acquisition/Switch System



## ► Features and Benefits

- Up to 320 switch channels per main frame, save on cost of ownership
- Can be Run without PC
- USB logging
- Interval scanning with storage of up to 100,000 time-stamped readings
- 10 kinds of cards supported
- 6 1/2 DMM can be enabled/disabled in any of slots
- Standard SCPI commands
- Math statistics:AVG, MAX, MIN, SDEV
- Cascade supported
- 4.3' LCD with intuitive GUI
- Powerful PC software and WebControl
- Full Interfaces supported: USB Device,USB Host, GPIB, LAN(LXI-C), RS232



Product Dimensions: Width X Height X Depth=239.0mm×159.0 mm×373.4 mm Weight: 5.7 kg(Without Package)

## ► Features and Benefits

- Channel Configuration Guide



Measurement Configuration



Scaling Configuration

- Channel Monitor



Single Channel Monitor



Multiple/All Channel Monitor

- Multi-View Switch



Display real-time scan information and all the measurement data of the channel selected



Draw scan data curves

- To Control Each Module Separately

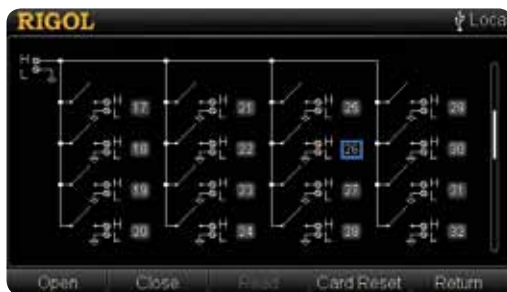

MC3164 Control Interface



MC3648 Control Interface

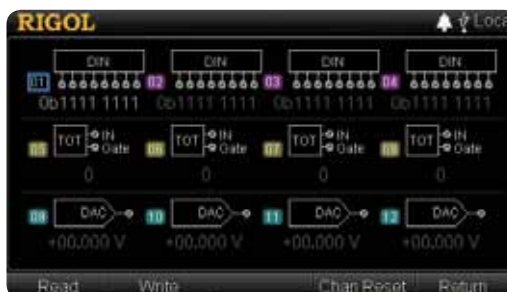

MC3534 Control Interface

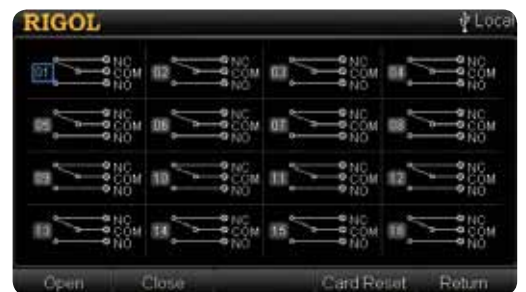

MC3416 Control Interface













· Channel Configuration of Ultra Acquire Pro









· Data Analysis of Ultra Acquire Pro



Modules/Terminal Box Supported by M300

Module	Terminal Box	Description
 DMM-MC3065		<ul style="list-style-type: none"> <li>·DMM module</li> <li>·Used to measure the signal</li> <li>·6½ digits</li> <li>·Support the following functions: DCV, ACV, DCI, ACI, 2WR, 4WR, FREQ, PERIOD, TEMP and any sensor</li> <li>·After connecting the DMM module, make sure that the signal under test connected to the analog bus is no greater than 300 Vdc or 300 Vrms</li> </ul>
 MUX32-MC3132	 TB32	<ul style="list-style-type: none"> <li>·32-channel multiplexer</li> <li>·All 32 channels switch both HI and LO inputs</li> <li>·Support 4-wire measurement</li> <li>·The signal to be tested is connected through the TB32 terminal box</li> <li>·Can be connected with MC3065</li> </ul>
 MUX64-MC3164	 TB64	<ul style="list-style-type: none"> <li>·64-channel single-ended multiplexer</li> <li>·All 64 channels can switch HI input only</li> <li>·Don't support 4-wire measurement</li> <li>·The signal to be tested is connected through the TB64 terminal box</li> <li>·Can be connected with MC3065</li> </ul>
 REEDMUX32-MC3232	 TB32	<ul style="list-style-type: none"> <li>·32-channel reed multiplexer</li> <li>·All 32 channels can switch both HI and LO inputs</li> <li>·Support 4-wire measurement</li> <li>·The signal to be tested is connected through the TB32 terminal box</li> <li>·Can be connected with MC3065</li> </ul>
 REEDMUX64-MC3264	 TB64	<ul style="list-style-type: none"> <li>·64-channel single-ended reed multiplexer</li> <li>·All 64 channels can switch HI input only</li> <li>·Don't support 4-wire measurement</li> <li>·The signal to be tested is connected through the TB64 terminal box</li> <li>·Can be connected with MC3065</li> </ul>
 MIX24-MC3324	 TB24	<ul style="list-style-type: none"> <li>·Mix multiplexer with 20 voltage channels and 4 current channels</li> <li>·All 20 voltage channels switch both HI and LO inputs</li> <li>·20 voltage channels support 4-wire measurement</li> <li>·4 current channels are used to measure DC current or AC current</li> <li>·The signal to be tested is connected through the TB24 terminal box</li> <li>·Can be connected with MC3065</li> </ul>



 <b>ACT-MC3416</b>	 <b>TB16</b>	<ul style="list-style-type: none"> <li>·16-channel actuator</li> <li>·Can connect signal to the device under test or enable external device</li> <li>·Any of the 16 channels can switch to Normally-Open (NO) and Normally-Closed (NC) states</li> <li>·The signal is connected through the TB16 terminal box</li> </ul>
 <b>MFC-MC3534</b>	 <b>TB34</b>	<ul style="list-style-type: none"> <li>·Multifunction module</li> <li>·DIO: four 8-bit digital input/output ports</li> <li>·TOT: four totalizer input terminals</li> <li>·DAC: four analog output terminals</li> <li>·The signal is connected through the TB34 terminal box</li> </ul>
 <b>MATRIX-MC3648</b>	 <b>TB48</b>	<ul style="list-style-type: none"> <li>·4×8 two-wire matrix switch</li> <li>·used to connect multiple devices to multiple points on the device under test</li> <li>·32 two-wire cross points which can connect any combination of inputs and outputs at the same time</li> <li>·The signal is connected through the TB48 terminal box</li> </ul>
 <b>RFMUX-MC3724</b>		<ul style="list-style-type: none"> <li>·Dual 4-channel RF multiplexer</li> <li>·consists of two independent 4-to-1 multiplexers and can switch high frequency signal or pulse signal</li> </ul>

## ► Ordering Information

Mainframe	Description	Ordering No.
	M300 Data Acquisition/Switch System	M300
	M300 Data Acquisition/Switch System + DMM Module	M301
Standard Accessories	Power Cord conforming to the standard of the country	-
	USB Cable	CB-USBA-USBB-FF-150
	Mixed-interface Separator Line	MIX-SEPARATOR
	Four Spare Fuses:	
	2 AC, 250 V, T3.15 A fuses	-
	2 AC, 250 V, T250 mA fuses	-
	Quick Guide	-
	Resource CD (User's Guide and Application Software)	-
Optional Accessories:Module	DMM Module (6½ digits)	MC3065
	32-channel Multiplexer	MC3132
	64-channel Single-ended Multiplexer	MC3164
	32-channel Reed Multiplexer	MC3232
	64-channel Single-ended Reed Multiplexer	MC3264
	20-voltage-channel+4-current-channel Mixed Multiplexer	MC3324
	16-channel Actuator	MC3416
	Multifunction Module	MC3534
	4×8 Matrix Switch	MC3648
	Dual 4-channel RF Multiplexer	MC3724
Optional Accessories:Terminal Box	MC3132/ MC3232 Terminal Box	M3TB32
	MC3164/MC3264 Terminal Box	M3TB64
	MC3324 Terminal Box	M3TB24
	MC3648 Terminal Box	M3TB48
	MC3534 Terminal Box	M3TB34
	MC3416 Terminal Box	M3TB16
Optional Accessories	RS232 Cable	-
	External Cable for Analog Bus Interface	A-BUS-EXT-LINE
	External Port for Analog Bus Interface	A-BUS-EXT-PORT
	Rack Mount Kit	RM-1-M300
	Rack Mount Kit for Two Instruments	RM-2-M300
	PC Software for M300 Series	Ultra Acquire Pro

# DP1000 Series Programmable DC Power Supply



- **Features and Benefits**
- DP1116A: 1 Output, DP1308A:3 Outputs
  - Low Ripple Noise: <350 uVrms
  - Excellent Power Regulation Rate and Load Regulation Rate
  - Fast Transient Response Time: <50us
  - Channel isolation and Voltage tracking(DP1308A)
  - Standard OVP/OCP/OTP protection functions
  - Remote Sense Capability(DP1116A)
  - Standard Timing function
  - Built in V,A,W measurements and waveform display
  - Independent control for each channel
  - 4.3 Inch TFT Display
  - Connectivity: USB Host&Device, LAN, GPIB

► **Features and Benefits**



DP1308A Setup Interface



DP1116A Setup Interface



Timing Output function

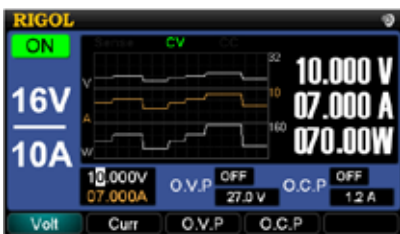

V,A,W measurements & waveform display



Standard OVP/OCP/OTP protection



Interface Setup



V/A/W Classic display



Store and recall system setups



On-line Help

## ► Key Specifications

Model	DP1116A		DP1308A		
Output Ranges/Channels	16V/10A	32V/5A	+6 V	+25 V	-25 V
DC Output ( 0°C – 40°C )					
Voltage	0 to 16 V	0 to 32 V	0 to +6V	0 to +25 V	0 to -25 V
Current	0 to 10 A	0 to 5 A	0 to 5 A	0 to 1 A	0 to 1 A
Overvoltage Protection	0.1 V to 35.2 V		0.1 V to 6.5 V	0.1 V to 27 V	-0.1 V to -27 V
Overcurrent Protection	0.1 A to 11 A		0.1 A to 5.5 A	0.1 A to 1.2 A	0.1 A to 1.2 A
Load Regulation± (output percentage + offset)					
Voltage	< 0.01% + 2 mV				
Current	< 0.005% + 250 µA		< 0.01% + 250 µA		
Line Regulation± (output percentage + offset)					
Voltage	< 0.01% + 2 mV				
Current	< 0.01% + 250 µA				
Ripple and Noise (20 Hz - 20 MHz)					
Normal Mode Voltage	< 350 µV rms/3 mVpp		< 350 µV rms/2 mVpp		
Normal Mode Current	< 2 mA rms		< 2 mA rms	< 500 µA rms	
Common Mode Current	-		<1.5 µA rms		
Accuracy 12 Months <sup>[1]</sup> (25°C ±5°C )±(output percentage + offset)					
Programming	Voltage	0.05% + 10 mV	0.1% + 5 mV	0.05% + 20 mV	
	Current	0.2% + 10 mA	0.2% + 10 mA	0.15% + 4 mA	
Read Back	Voltage	0.05% + 5 mV	0.1% + 5 mV	0.05% + 10 mV	
	Current	0.15% + 5 mA	0.2% + 10 mA	0.15% + 4 mA	
Resolution					
Programming	1 mV/1 mA		0.5 mV/0.5 mA	1.5 mV/0.1 mA	
Read Back	1 mV/1 mA		0.5 mV/0.5 mA	1.5 mV/0.1 mA	
Meter	1 mV/1 mA		1 mV/1 mA	10 mV/1 mA	
Transient Response Time					
Less than 50 µs is spent on recovering the voltage within 15 mV during the output current changes from full load to half load or half to full.					
Command Processing Time <sup>[2]</sup>					
< 50 ms					
Temperature Coefficient per °C (output percentage + offset)					
Voltage	0.01% + 3 mV		0.01% + 2 mV	0.01% + 3 mV	
Current	0.02% + 5 mA		0.02% + 3 mA	0.01% + 0.5 mA	
Stability <sup>[3]</sup> , ±(output percentage + offset)					
Voltage	0.02% + 1 mV		0.03% + 1 mV	0.02% + 2 mV	
Current	0.1% + 1 mA		0.1% + 3 mA	0.05% + 1 mA	
Machine					
Dimension	235 mm (W) x 155 mm (H) x 384 mm (D)				
Weight	11 kg		8.5 kg		

Remarks:

[1]Specifications are for one hour warm-up and at 25°C .

[2]The maximum time required for regulating corresponding output when received APPLy and SOURce commands.

[3]The variation of output within 8 hours after warm-up 30 minutes and both the load circuit and environment temperature are in constant conditions.

## ► Ordering Information

	Description	Order Number
Model	Programmable DC Power (Single Channel)	DP1116A
	Programmable DC Power (Triple-Channel)	DP1308A
Standard	A Power cord	
Accessories	A USB data cable	
	Two shorted devices (only for DP1116A)	
	A CD (including User's Guide and Programming Guide)	
	Four fuses (two of 250 V/T2.5 A and two of 250 V/T4 A): DP1116A	
	Four fuses (two of 250 V/T3 A and two of 250 V/T2 A): DP1308A	
	Rack Mount Kit	RM-DP-1
	An INSTRUCTION	

# DP800 Series Programmable DC Power Supply



## ► Features and Benefits

- DP832A/832:3 Channels,CH1||CH2,CH3, Total Power up to 195W
- DP831A:3 Channels,CH1||CH2,CH3, Total Power up to 160W
- DP811A:1 Channel,Dual Range 40V/5A or 20V/10A, Total Power up to 200W, with Remote Sense
- DP821A:2 Channels,60V/1A || 8V/10A, Total Power up to 140W,with Remote Sense
- Low Ripple Noise: <350 uVrms/2mVpp
- Excellent Line Regulation Rate and Load Regulation Rate
- Fast Transient Response Time: <50us
- Standard OVP/OCP/OTP protection functions
- Standard Timing function
- Built in V,A,W measurements and waveform display
- Support Output Delay, Analysis, Monitor, Preset functions
- Independent control for each channel
- 3.5 Inch TFT Display
- Connectivity: USB Host& Device, LAN, RS232, Digital IO, USB-GPIB(Opt.)

## ► Features and Benefits

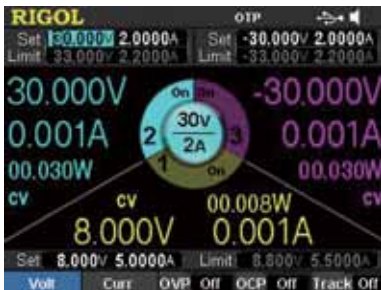

DP831A GUI



DP832A GUI



DP832 GUI



Timing Output



V/A/W Display

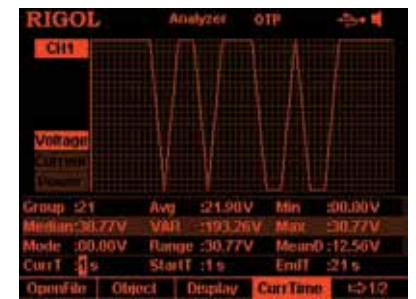

Output Analysis Function



Monitor Setup



Trigger In/Out

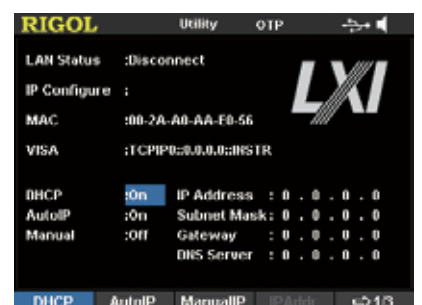

LAN Setup



## ► Key Specifications

Model	DP832A	DP832	DP831A	DP821A	DP811A	
Channels		3		2	1 (2 output ranges)	
DC Output (0°C to 40°C )						
Voltage/current	CH1	0 to 30V/0 to 3A	0 to 8V/0 to 5A	0~60V/0~1A	Range 1: 0~20V/0~10A Range 2: 0~40V/0~5A	
	CH2	0 to 30V/0 to 3A	0 to +30V/0 to 2A	0~8V/0~10A	None	
	CH3	0 to 5V/0 to 3A	0 to -30V/0 to 2A	None	None	
Load Regulation Rate $\pm$ (Output Percentage + Offset)						
Voltage	<0.01%+2mV					
Current	<0.01%+250 $\mu$ A					
Linear Regulation Rate $\pm$ (Output Percentage + Offset)						
Voltage	<0.01%+2mV					
Current	<0.01%+250 $\mu$ A					
Ripples and Noise (20Hz to 20MHz)						
Normal Mode Voltage	<350 $\mu$ Vrms/2mVpp					
Normal Mode Current	<2mArms					
Annual Accuracy <sup>[1]</sup> (25°C $\pm$ 5°C ) $\pm$ (Output Percentage + Offset)						
Programming						
Voltage	CH1	0.05% + 20mV	0.1%+5mV	<0.1%+25mV	0.05%+10mV	
	CH2	0.05% + 20mV	0.05%+20mV	<0.05%+10mV	None	
	CH3	0.1% + 5mV	0.05%+20mV	None	None	
Current	CH1	0.2% + 5mA	0.2%+10mA	0.2%+10mA	0.1%+10mA	
	CH2	0.2% + 5mA	0.2%+5mA	0.2%+10mA	None	
	CH3	0.2% + 5mA	0.2%+5mA	None	None	
Readback						
Voltage	CH1	0.05% + 10mV	0.1%+5mV	<0.1%+25mV	0.05%+10mV	
	CH2	0.05% + 10mV	0.05%+10mV	0.05%+5mV	None	
	CH3	0.1% + 5mV	0.05%+10mV	None	None	
Current	CH1	0.15%+ 5mA	0.2%+10mA	0.15%+10mA	0.1%+10mA	
	CH2	0.15%+ 5mA	0.1%+5mA	0.15%+10mA	None	
	CH3	0.15%+ 5mA	0.1%+5mA	None	None	
Resolution						
Programming	Voltage	1mV	10mV With high-resolution option: 1mV	1mV	CH1: 10mV CH2: 1mV	1mV
	Current	1mA	1mA	CH1: 0.3mA CH2/CH3: 0.1mA	CH1: 0.1mA CH2: 1mA	0.5mA
Readback	Voltage	0.1mV	10mV With high-resolution option: 0.1mV	0.1mV	1mV	0.1mV
	Current	0.1mA	1mA With high-resolution option: 0.1mA	0.1mA	CH1: 0.1mA CH2: 1mA	0.1mA
Display	Voltage	1mV	10mV With high-resolution option: 1mV	1mV	CH1: 10mV CH2: 1mV	1mV
	Current	1mA	10mA With high-resolution option: 1mA	1mA	CH1: 0.1mA CH2: 1mA	1mA
Mechanical						
Dimensions	239mm(W) x 157mm(H) x 418mm(D)					
Weight	10.5kg		9.75kg	10.0kg	10.3kg	
I/O						
USB Device	1	1	1	1	1	
USB Host	1	1	1	1	1	
LAN	1	Option	1	1	1	
RS232	1	Option	1	1	1	
Digital IO	1	Option	1	1	1	
USB-GPIB	Option	Option	Option	Option	Option	

Note:

[1] The accuracy parameters are acquired via calibration under 25°C after 1-hour warm-up.

[2] The maximum time required for the output to change accordingly after receiving the APPLY and SOURce commands.

[3] The variation of the output within 8 hours after 30-minute warm-up when the load circuit and environment temperature are constant.



## ► Ordering Information

	Description	Order Number
Model	Programmable DC Power (3 Channels)	DP832A
	Programmable DC Power (3 Channels)	DP832
	Programmable DC Power (3 Channels)	DP831A
	Programmable DC Power (2 Channels)	DP821A
	Programmable DC Power (1 Channel)	DP811A
Standard Accessories	Power cord	-
	USB data cable	CB-USBA-USBB-FF-150
	One shorted device	-
	CD (including User's Guide and Programming Guide)	-
	One fuse(50T-025H 250V 2.5A)	-
	Quick Guide	-
Optional Accessories	1mV & 1mA High resolution option(DP832)	HIRES-DP800
	4 Lines Trigger In&Out(DP832)	DIGITALIO-DP800
	On-line Monitoring and analysis(DP832)	AFK-DP800
	RS232 and LAN interface(DP832)	INTERFACE-DP800
	USB to GPIB Converter	USB-GPIB
	2 Units Rack Mount Kit	RM-2-DP800

## RIGOL Instrument PC Software

### ► RIGOL Universal PC Control Software



#### Ultra Sigma

Support: All RIGOL new Instruments  
OS: Windows XP/7/Vista  
Free/Charge: Free

##### Main Features and Benefits

- Easy connection to RIGOL instruments with GPIB, USB-TMC, LAN, RS-232
- Search RIGOL Instruments
- Interactive control :Send SCPI commands and read responses
- Add, monitor , manage Application softwares
- Parameters configuration

### ► Power supply PC Software



#### UltraPower

Support: DP1308, DP1116  
OS: Windows XP  
Free/Charge: Free

##### Main Features and Benefits

- Setup the parameters of each channel
- On/Off control for each channel
- Output V,A,W waveform display
- V,A,W waveform data storage

► **Digital Oscilloscope PC Software**

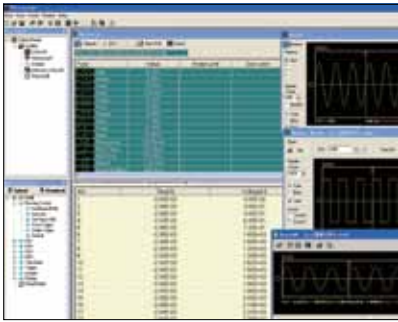

Ultrascope for DS1000B series

**Support:** DS1000B  
**OS:** Windows 7/XP/2000  
**Free/Charge:** Free

**Main Features and Benefits**

- Setup each function and parameter of the scope
- Remote control the scope with Virtual Panel
- Show the waveform, data and measurement results
- Replay the recorded waveform
- Save the waveform with Picture or Data format

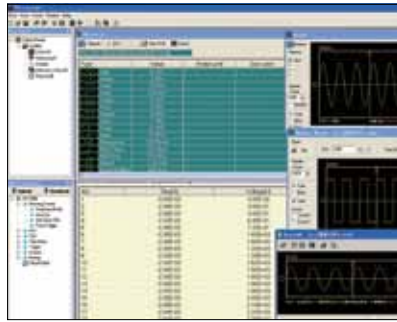

Ultrascope for DS1000D series

**Support:** DS1000D  
**OS:** Windows XP/2000/NT4.0  
**Free/Charge:** Free

**Main Features and Benefits**

- Setup each function and parameter of the scope
- Remote control the scope with Virtual Panel
- Show the waveform, data and measurement results
- Replay the recorded waveform
- Save the waveform with Picture or Data format



Ultrascope for DS1000E series

**Support:** DS1000E  
**OS:** Windows XP/2000/NT4.0  
**Free/Charge:** Free

**Main Features and Benefits**

- Setup each function and parameter of the scope
- Remote control the scope with Virtual Panel
- Show the waveform, data and measurement results
- Replay the recorded waveform
- Save the waveform with Picture or Data format

► **Power Measurement and Analysis Software**

Current Harmonics Analysis



Inrush Current Analysis

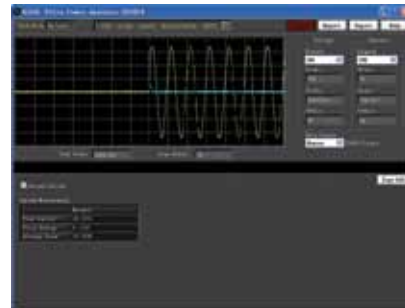

Safety Operating Area Analysis



Ultra Power Analyzer

**Support:** DS4000/MO4000, DS2000/DS2000A  
**OS:** Windows XP/7/Vista  
**Free/Charge:** Charge (On-line mode)

**Main Features and Benefits**

- Power quality measurement
- Current Harmonics measurement
- Inrush Current measurement
- Power Device Analysis
- Safe Operating Area analysis
- Modulation measurement
- Output analysis
- Generate Measurement Report

## ► Function/Arbitrary Waveform Generator PC Software



### Ultra Station

**Support:** DG5000/DG4000  
**OS:** Windows XP  
**Free/Charge:** Free/Charge(Opt.)

#### Main Features and Benefits

- Arbitrary Waveform Edit:
  - ◊ Insert Standard Wave
  - ◊ Draw waveform
  - ◊ Formula Edit(Opt.)
  - ◊ Basic Math
  - ◊ Filtering & Windowing(Opt.)
- Arbitrary Waveform file import and download

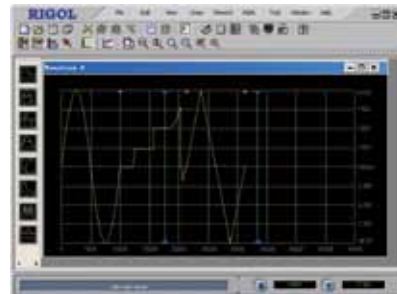

### Ultrawave

**Support:** DG1000/DG2000/DG3000  
**OS:** Windows XP/2000  
**Free/Charge:** Free

#### Main Features and Benefits

- Arbitrary Waveform Edit:
  - ◊ Insert Standard Wave
  - ◊ Draw waveform
  - ◊ Basic Math
  - ◊ Advanced Math
  - ◊ Filtering & Windowing
- Arbitrary Waveform file import and download



### PA1000 Control

**Support:** PA1000  
**OS:** Windows XP  
**Free/Charge:** Free

#### Main Features and Benefits

- Control PA1011

## ► Spectrum Analyzer PC Software

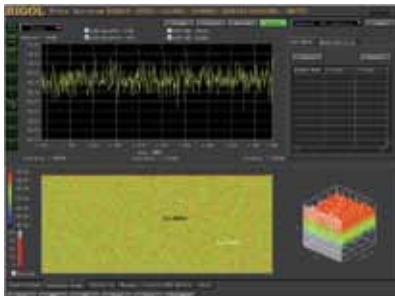

### Ultra Spectrum

**Support:** DSA1030A/1030/1020/815  
**OS:** Windows XP/7/Vista  
**Free/Charge:** Charge

#### Main Features and Benefits

- Setup each function and parameter of the spectrum analyzer
- Remote control
- Show the spectrum and measurement results
- Water fall and 3-D display
- Save the spectrum with Picture or Data format



### TX1000

**Support:** TX1000  
**OS:** Windows XP/7/Vista  
**Free/Charge:** Free

#### Main Features and Benefits

- Control the electronic switches in the TX1000.
- TX1000 could be controlled by DSA815 directly also.

► Digital Multimeter PC Software

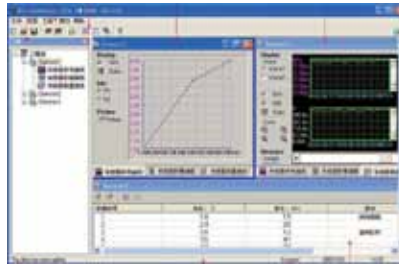

**Ultra View**

**Support:** DM3058  
**OS:** Windows XP  
**Free/Charge:** Charge

**Main Features and Benefits**

- Remote control with Virtual Panel
- Data Trend Record, Monitor and Analysis
- Save Data to csv file

**Ultra Senser**

**Support:** DM3058/3068  
**OS:** Windows XP/2000/Server2003  
**Free/Charge:** Free

**Main Features and Benefits**

- Build Sensor Project and Download to DMM
- Real time measure the signal from the sensor,
- Save the measurement result with Data or picture format

► M300 Data Acquisition PC Software



**Ultra Acquire**

**Support:** M300,M301  
**OS:** Windows XP  
**Free/Charge:** Free

**Main Features and Benefits**

- Channel configuration
- Scan configuration
- Generate the report

**Ultra Acquire Pro**

**Support:** M300,M301  
**OS:** Windows XP  
**Free/Charge:** Charge

**Main Features and Benefits  
 (3 additional functions)**

- Data re-calculate
- Data print
- All history data display

## ► DSG3000 RF Source PC Software



### Ultra IQ Station

**Support:** DSG3030/3060

**OS:** Windows XP/Vista / 7

**Free/Charge:**Free

#### Main Features and Benefits

- Configure the Data source
- Configure the Modulation type
- Configure the filtering
- IQ Waveform/Spectrum/Constellation Display
- Download to instrument or save to a file

## Warranty

Three-year warranty,excluding probes and accessories.

**RIGOL**

### Headquarter

RIGOL TECHNOLOGIES, INC.  
No.156,Cai He Village,  
Sha He Town,  
Chang Ping District, Beijing,  
102206 P.R.China  
Tel:+86-10-80706688  
Fax:+86-10-80705070  
Email: support@rigol.com

### USA

RIGOL TECHNOLOGIES , USA  
INC.  
7401 First Place, Suite N  
Oakwood Village  
OH 44146, USA  
Toll free: 877-4-RIGOL-1 ×111  
Tel: 440-232-4488 ×111  
Fax: 440-232-4499  
Email: info@rigol.com

### Europe

RIGOL TECHNOLOGIES EU,  
GmbH  
Lindbergh str. 4  
82178 Puchheim, Germany  
Tel: +49(0)89-8941895-0  
Email: info-europe@rigol.com



**Batronix**      [www.batronix.com](http://www.batronix.com)  
**Lise-Meitner-Str. 1-7**  
**24223 Schwentinental**  
**Germany**

RIGOL® is the registered trademark of RIGOL Technologies, Inc. Product information in this document subject to update without notice. For the latest information about RIGOL's products, applications and services, please contact local RIGOL office or access RIGOL official website:

[www.rigol.com](http://www.rigol.com)