

N110204b

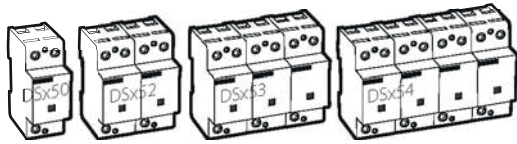

INSTALLATION INSTRUCTIONS - NOTICE D'INSTALLATION
 NOTICIA DE INSTALACIÓN - INSTALLATIONSHINWEISE
 ISTRUZIONI PER L'INSTALLAZIONE
 INSTRUCOES DE INSTALCAO - MONTÁŽNÍ NÁVOD
 РУКОВОДСТВО ПО МОНТАЖУ - 安装指导书

AC surge protector - Parafoudre Basse Tension
 Protectiones Baja Tension
 Überspannungsschutz für Niederspannungsnetze
 Scaricatori da sovratensioni per rete di energia
 Protetor de Surto CA. - Svodiče přepětí pro AC
 Устройство защиты от импульсных перенапряжений, AC - 低压浪涌保护器



DS150VG/DS250VG Series

Technical Data

2000 m max.
 6500 ft max.
 -40/+85°C max.
 -40/+185°F max.
 IP20
 indoor use only

AC Network

	DS152VG-120	DS152VG-120/G	DS153VG-120	DS154VG-120	DS154VG-120/G	DS152VG-300	DS152VG-300/G	DS153VG-300	DS154VG-400	DS154VG-400/G	DS252VG-120	DS252VG-120/G	DS253VG-120	DS253VG-120/G	DS254VG-120	DS254VG-120/G	DS252VG-300	DS252VG-300/G	DS253VG-300	DS254VG-300	DS254VG-300/G	DS252VG-400	DS252VG-400/G	DS253VG-400	DS253VG-400/G	DS254VG-400	DS254VG-400/G	DS100EG-350	DS100EG-600	DS100EG-1200	DS1000G-600	
120 Vac L+N	●	●									●	●																				
208 Vac 3L			●										●																			
120/208 Vac 2L+N																																
120/208 Vac 3L+N				●	●																											
230 Vac L+N						●	●																									
230 Vac 2L+N																																
400 Vac 3L																																
230/400 Vac 2L+N																																
230/400 Vac 3L+N																																
N/PE only																																

Characteristics

IPE*	0 mA			
IscCR*	50 kA			N/A
I _{max} *	40 kA		70 kA	
I _{imp} *	15 kA		25 kA	
			50kA	100kA

*values per pole

Table 1

Installation

	min-max	
	6 - 50 mm ²	11 - 3 AWG
	6 - 35 mm ²	9 - 3 AWG

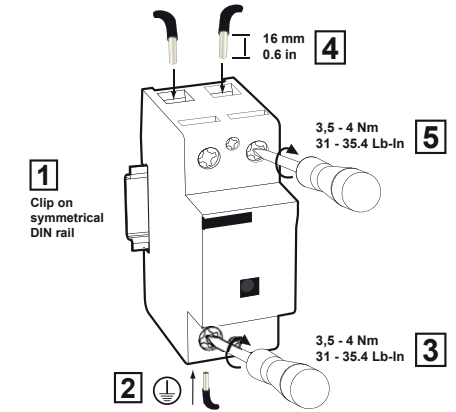

Wiring

Standard wiring

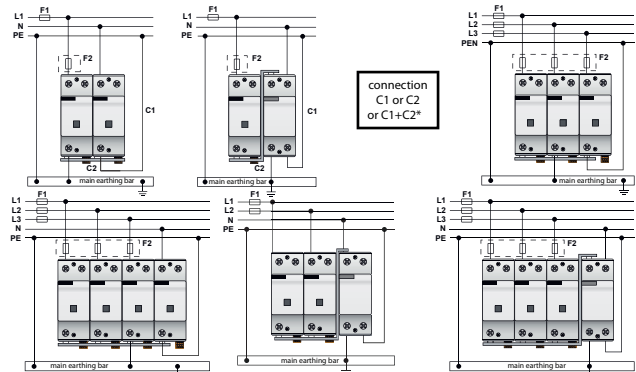

V-diagram wiring

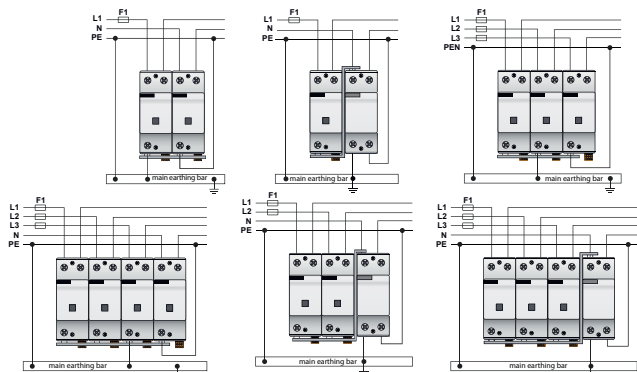

Remote contact wiring

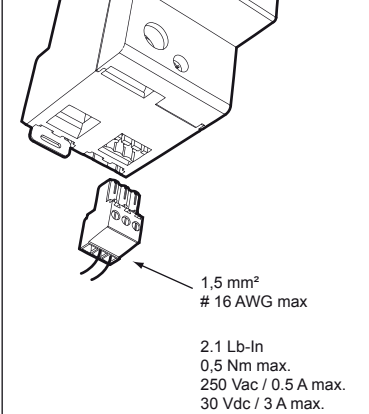

Remote signal for disconnection information

11-12 Closed = SPD OK
 11-14 Open = SPD OK
 11-12 Open = SPD disconnect
 11-14 Closed = SPD disconnect

Table 2

Table 3

Maintenance

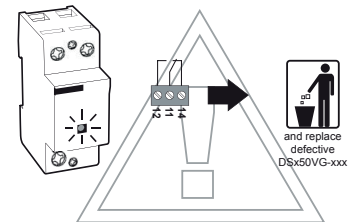
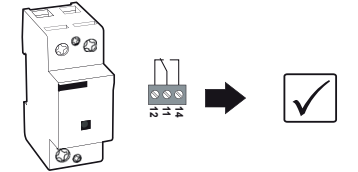

* for Germany both connections are mandatory : Solution ① or ②



CITEL

SAFETY INSTRUCTIONS
 CONSIGNES DE SECURITE
 SICHERHEITSHINWEISE
 ADVERTENCIA DE SEGURIDAD
 AVVERTENZE IMPORTANTI
 AVISOS IMPORTANTES
 МЕРЫ БЕЗОПАСНОСТИ
 BEZPEČNOSTNÍ POKYNY
 安全須知



*This document could be modified without notice.
 Updated Information on Website.*

*Ce document peut être modifié sans préavis.
 Informations à jour sur site web.*

*Änderungen am Dokument sind ohne Ankündigung möglich.
 Aktuelle Informationen finden Sie auf unserer Webseite.*

*Este documento puede ser modificado sin previo aviso.
 Información actualizada en el sitio web.*

*Questo documento può essere modificato senza preavviso.
 Informazioni attualizzate disponibili sul sito web.*

*Este documento pode ser modificado sem aviso prévio.
 Informação atualizada no website.*

*В документ могут вноситься изменения.
 Актуальную информацию смотрите на нашей
 WEB-странице.*

*Změny v tomto dokumentu jsou možné bez předchozího
 upozornění.*

Aktuální informace najdete na naší webové stránce.

*本文件的修改恕不另行通知。
 查看最新文件请登陆公司网站。*

www.citel.fr
www.citel.de
www.citel.us
www.citel.com.cn
www.citel.ru
www.citel.in

2, rue Troyon 92316 Sèvres CEDEX France



ATTENTION !

GB

- Installation must be performed only by electrically skilled operator.
- National electrical installation rules must be followed.
- The unit must be used only as surge protector and according the conditions described in this document.
- Surge protectors must be selected in relation with an dedicated AC network (see Table 1)
- Dedicated fuses must be installed in the surge protector branch (see Table 2).
- In case of red indicator, the surge protector must be replaced.



ATTENTION !

FR

- L'installation ne doit être effectuée que par un opérateur électricien dûment qualifié.
- Les règles générales d'installation électrique nationales doivent être respectées.
- Le produit est uniquement destiné à un usage parafoudre et doit être utilisé dans les conditions décrites dans ce document.
- Les parafoudres sont utilisés en fonction d'un réseau BT déterminé (voir table 1)
- Des fusibles dédiés doivent être installés dans les branches du parafoudre (voir table 2)
- En cas d'indicateur passant au rouge, le parafoudre doit être remplacé.



WARNING !

D

- Die Montage und der Anschluss des Gerätes dürfen nur durch eine Elektrofachkraft durchgeführt werden.
- Nationale Installations Vorschriften sind zu beachten.
- Das Gerät ist nur im Rahmen dieser Installationshilfe und seiner technischen Daten zu verwenden.
- Die Ableiter sind nach der Niederspannungsnetzform auszuwählen (siehe Tabelle 1).
- Die Vorsicherungen sind nach der Tabelle 2 zu selektieren und zu installieren.
- Ist die Anzeige im Sichtfenster auf ROT umgeschaltet, so ist das Modul DEFECT und muss ausgetauscht werden.



ATENCION !

ES

- Solo un operador eléctrico capacitado puede realizar la instalación.
- Las reglas generales nacionales de instalación eléctrica deben ser respetadas.
- El producto solo tiene un uso de protección contra sobretensiones transitorias y debe ser utilizado en las condiciones mencionadas en este documento.
- Las protecciones contra sobretensiones transitorias se usan en relación con una red de baja tensión determinada (ver tabla 1).
- Fusibles dedicados deben ser instalados aguas arriba de la protección, en la conexión en paralelo (ver tabla 2).
- Se debe sustituir la protección cuando el indicador esta puesto en rojo.



ATTENZIONE !

IT

- L'installazione deve essere fatta solamente da elettricisti qualificati.
- Devono essere rispettate le regolamentazioni nazionali e locali riguardanti l'installazione di apparati elettrici.
- L'unità deve essere usata solo come protezione da sovratensioni e secondo le condizioni descritte in questo documento.
- Le protezioni da sovratensione devono essere scelte in funzione della corrente alternata di rete (vedere la tabella 1).
- Fusibili dedicati devono essere installati nel ramo protetto da sovratensione (vedere la tabella 2).
- Nel caso in cui si accenda l'indicatore rosso, l'unità di protezione da sovratensione deve essere sostituita.



AVISO !

PT

- A instalação deve ser feita por um electricista habilitado.
- Devem ser seguidas todas as regras de segurança indicadas pelo operador eléctrico.
- Esta protecção deve ser utilizada apenas como protecção contra sobretensões e de acordo com as condições mencionadas neste documento.
- A protecção deve ser escolhida de acordo com a rede eléctrica AC (ver quadro 1).
- Devem ser instalados fúsiveis de protecção a montante da protecção (ver quadro 2).
- Caso o indicador vermelho esteja activo, dever-se-á substituir a protecção.



ВНИМАНИЕ!

RUS

- монтаж и подключение изделия должны производиться только специалистами-электриками.
- необходимо учитывать требования местных норм и стандартов.
- изделие может использоваться только для защиты от импульсных перенапряжений в соответствии с настоящей инструкцией.
- параметры сети должны соответствовать характеристикам изделия (см. таблицу 1).
- обязательна установка токовых предохранителей соответствующего номинала (таблица 2).
- при обнаружении индикатора состояния красного цвета изделие должно быть заменено.



VAROVÁNÍ

- Montáž a připojení svodiče přepětí smí provádět pouze pracovník s příslušnou elektrotechnickou kvalifikací.
- Je zapotřebí dodržovat zásady bezpečnosti práce i platné národní elektrotechnické předpisy.
- Svodič přepětí se smí používat pouze v souladu se svými technickými parametry a podle těchto montážních pokynů.
- Svodiče přepětí je zapotřebí zvolit a používat tak, aby odpovídaly napájecí síti (viz tabulka 1).
- Potřeba instalace pojistek pro předjištění před svodiče a jejich volba - viz tabulka 2.
- Pokud ukazatel správné funkce má ČERVENOU barvu, pak svodič/modul je VADNÝ a musí být vyměněn.



安全須知!

中文

- 产品安装只能由具备专业资质的人员实施；
- 请遵守国家电气安装相关规范；
- 本产品仅作为浪涌保护器且在本文件所规定的条件下使用；
- 请根据不同的电源网络制式选用浪涌保护器，参见 Table 1；
- 请在浪涌保护器前端安装规定的熔断器，参见 Table 2；
- 当状态指示变为红色时，须及时更换浪涌保护器；