

- ◆ MOSFET or IGBT Output
- ◆ Low Impedance
- ◆ 4-32VDC Control Input
- ◆ Load Current:7A-100A
- ◆ Dielectric Strength: 2500Vrms
- ◆ Internal Over-voltage Protection
- ◆ LED Indicator
- ◆ RoHS Compliant



Ordering Information

KSJ	50	D	40	-L	(XXX)
KSJ Series (1)	Load Voltage 30: 30VDC 50: 50VDC 60: 60VDC 100: 100VDC 200: 200VDC 400: 400VDC 600: 600VDC 1200: 1200VDC	DC Control	Load Current 7: 7Amp 10: 10Amp 20: 20Amp 25: 25Amp 40: 40Amp 50: 50Amp 80: 80Amp 100: 100Amp	LED Indicator	Customized Code

Note (1): The part number selection is subject to the following list.

	30VDC	50VDC	60VDC	100VDC	200VDC	400VDC	600VDC	1200VDC
7A			KSJ60D7-L					
10A					KSJ200D10-L			
20A				KSJ100D20-L	KSJ200D20-L			
25A						KSJ400D25-L	KSJ600D25-L	KSJ1200D25-L
40A		KSJ50D40-L		KSJ100D40-L	KSJ200D40-L			
50A	KSJ30D50-L		KSJ60D50-L				KSJ600D50-L	KSJ1200D50-L
80A		KSJ50D80-L		KSJ100D80-L				
100A	KSJ30D100-L							

Input Specifications (Ta=25°C)

Control Voltage Range	4-32VDC
Must Turn-On Voltage	4VDC
Must Turn-Off Voltage	1VDC
Maximum Input Current	25mA @32VDC
Maximum Reverse Voltage	32VDC

General Specifications

Output Specifications (Ta=25°C)																		
	KSJ30D□-L		KSJ50D□-L		KSJ60D□-L		KSJ100D□-L				KSJ200D□-L		KSJ400D25-L		KSJ600D□-L		KSJ1200D□-L	
	50	100	40	80	7	50	20	40	80	100	10	20	40		25	50	25	50
Load Voltage Range (VDC)	0-24		0-36		0-48		0-75				0-120		0-300		0-500		0-650	
Maximum Load Current (A)	50	100	40	80	7	50	20	40	80	100	10	20	40	25	25	50	25	50
Maximum Surge Current (Apk.@10ms)	150	250	120	200	30	150	60	120	200	250	30	60	120	150	150	300	150	300
Maximum On-State Resistance (mΩ)	4.2	2.1	12	6	14	7	13	13	6.5	6.5	60	30	30					
Maximum On-State Voltage Drop@Rated Current (V)															1.75			
Maximum Off-State Leakage Current@Rated Load Voltage (mA)											0.1				0.5			
Minimum Load Current (mA)											2				2			
Maximum Turn-On Time (ms)											0.1				1			
Maximum Turn-Off Time (ms)											0.1				1			

General Specifications (Ta=25°C)		
Dielectric Strength (50/60Hz)	Input/Output	2500Vrms
	Input, output/Base	2500Vrms
Minimum Insulation Resistance (@500VDC)	1000MΩ	
Ambient Temperature Range	-30°C ~ +80°C	
Storage Temperature Range	-30°C ~ +100°C	
Weight (Typical)	100g	

Applications

Control heating, DC power supplies, electromechanical valves, motors, medical equipment, and etc.

Outline Dimensions/Wiring Diagram

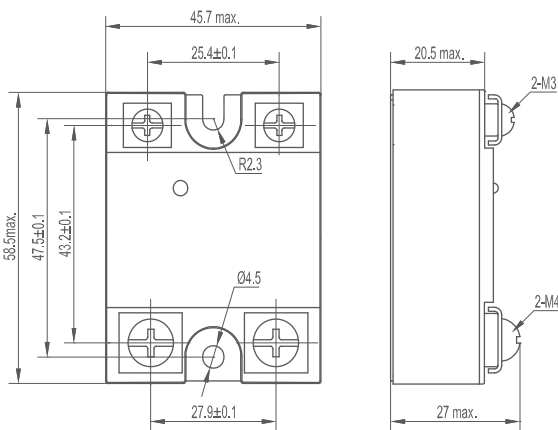

Outline Dimensions

Wiring Diagram

When the relay is used for inductive load control, please be sure to use a suppression circuit, just like the drawing above. Both load terminals are inverse paralleled with a fly-wheel diode D1.
D1: Fast Recovery Diode

Thermal Derating Curve

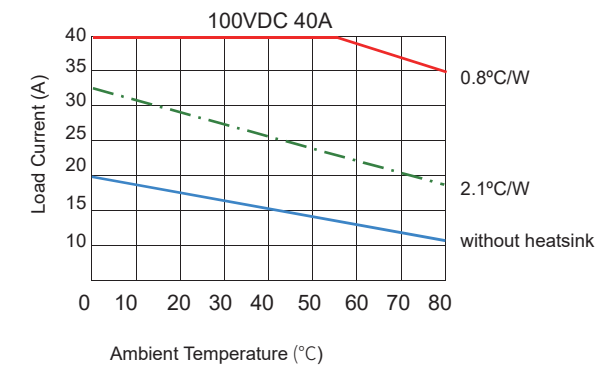
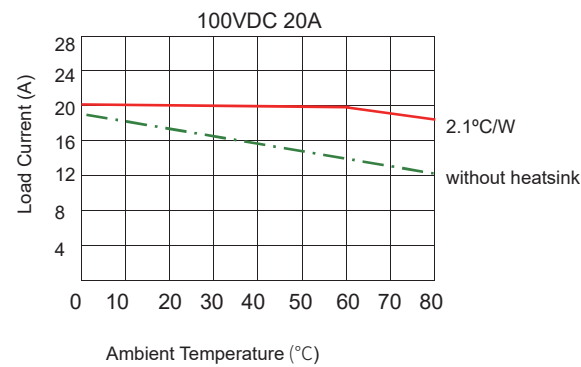
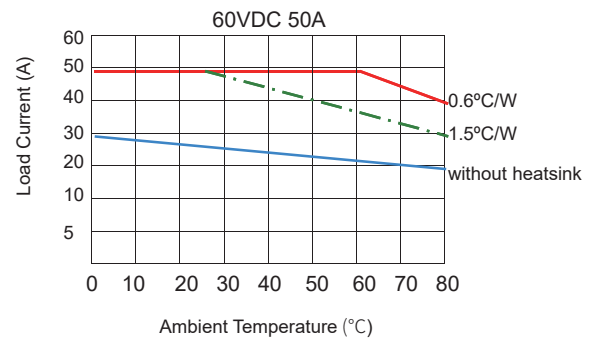
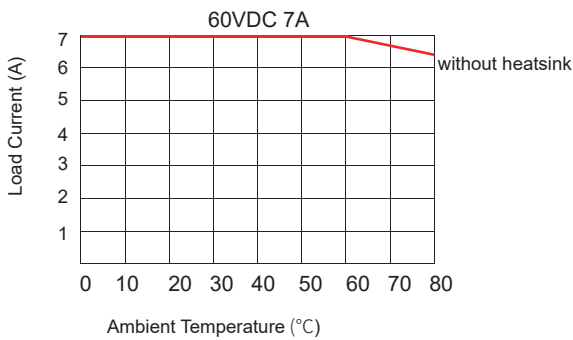
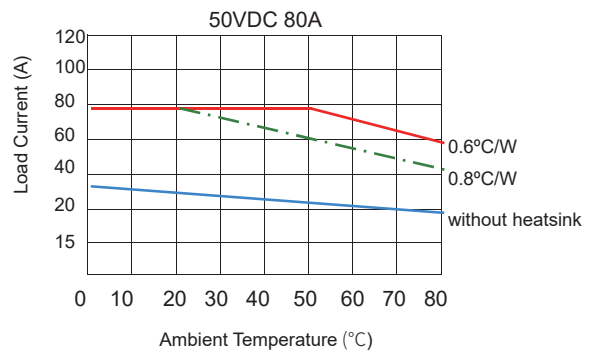
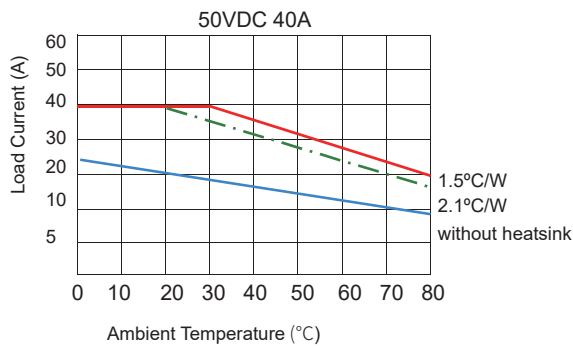
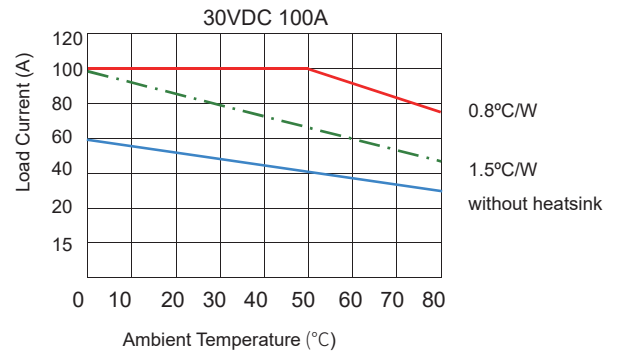
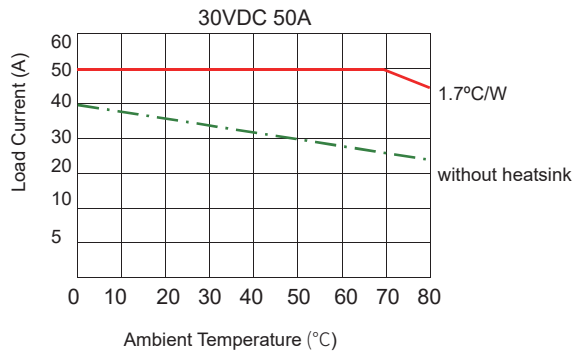

Thermal Derating Curve

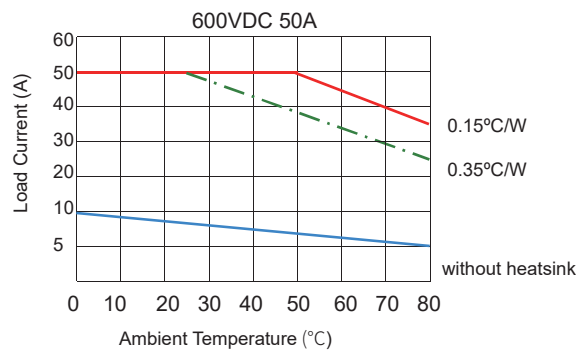
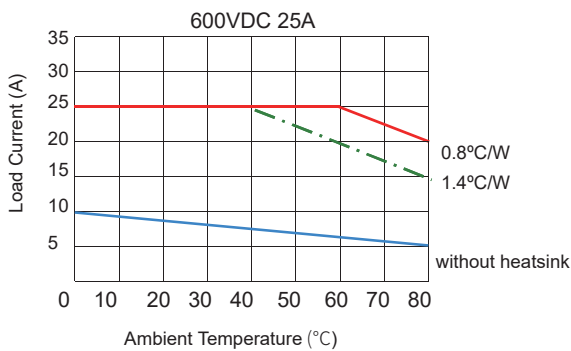
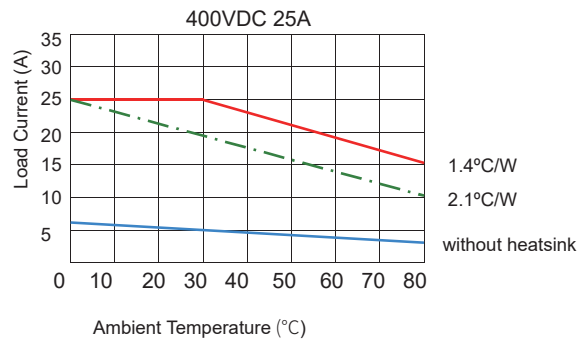
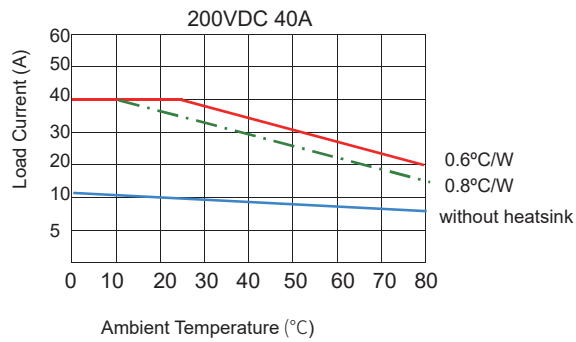
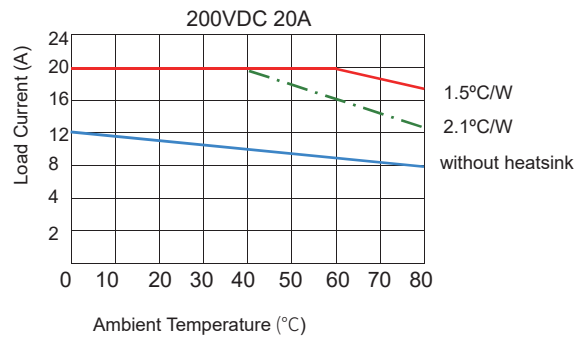
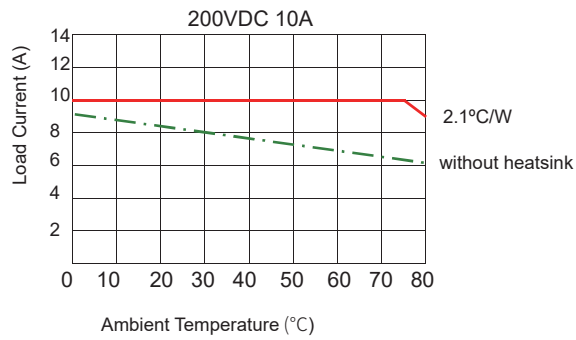
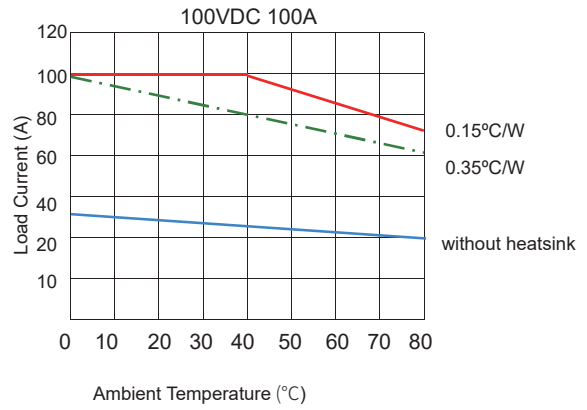
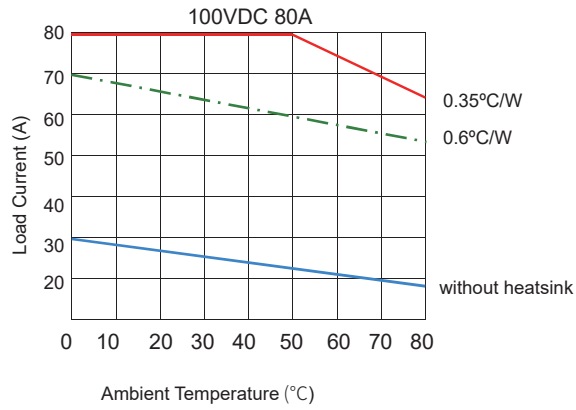

Thermal Derating Curve

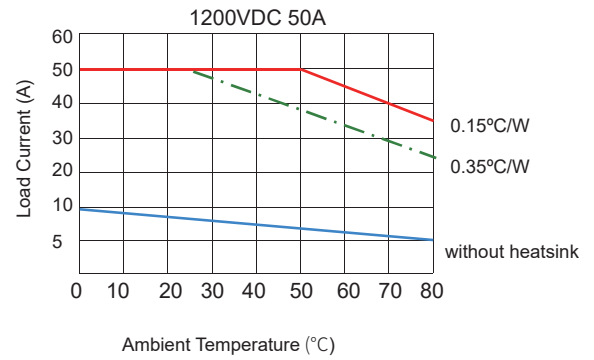
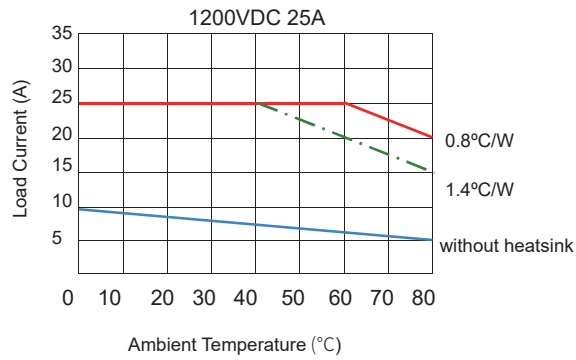

General Notes

1. Relay must be mounted to proper sized heat sink based on thermal curves. Thermal grease or a thermal pad must be used between relay and heat sink and be torqued down to 18-20/2.0-2.2 in-lb/N·m.
2. When connection wiring to SSR please ensure screws are torqued down properly (input 13-15/1.5-1.7in/lb/N·m, output 18-20/2.0-2.2 in-lb/N·m).
3. When Ambient temperature is above 25°C see thermal derating curve.

Agency Approvals (Certification)

