

## Low drop-out voltage regulator

Order code	Manufacturer code	Description
82-0678	LM2940CT-5.0	LM2940CT-5 1A REGULATOR (RC)

<p>Low drop-out voltage regulator</p> <p>The enclosed information is believed to be correct, Information may change 'without notice' due to product improvement. Users should ensure that the product is suitable for their use. E. &amp; O. E.</p>	<p>Page 1 of 15</p> <p>Revision A</p> <p>12/12/2006</p>
---	---

## LM2940/LM2940C 1A Low Dropout Regulator

### General Description

The LM2940/LM2940C positive voltage regulator features the ability to source 1A of output current with a dropout voltage of typically 0.5V and a maximum of 1V over the entire temperature range. Furthermore, a quiescent current reduction circuit has been included which reduces the ground current when the differential between the input voltage and the output voltage exceeds approximately 3V. The quiescent current with 1A of output current and an input-output differential of 5V is therefore only 30 mA. Higher quiescent currents only exist when the regulator is in the dropout mode ( $V_{IN} - V_{OUT} \leq 3V$ ).

Designed also for vehicular applications, the LM2940/LM2940C and all regulated circuitry are protected from reverse battery installations or 2-battery jumps. During line transients, such as load dump when the input voltage can momentarily exceed the specified maximum operating volt-

age, the regulator will automatically shut down to protect both the internal circuits and the load. The LM2940/LM2940C cannot be harmed by temporary mirror-image insertion. Familiar regulator features such as short circuit and thermal overload protection are also provided.

### Features

- Dropout voltage typically 0.5V @  $I_O = 1A$
- Output current in excess of 1A
- Output voltage trimmed before assembly
- Reverse battery protection
- Internal short circuit current limit
- Mirror image insertion protection
- P+ Product Enhancement tested

### Typical Application

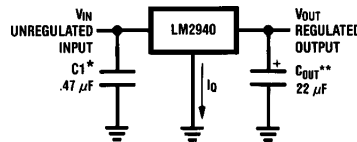

TL/H/8822-3

\*Required if regulator is located far from power supply filter.

\*\* $C_{OUT}$  must be at least 22  $\mu F$  to maintain stability. May be increased without bound to maintain regulation during transients. Locate as close as possible to the regulator. This capacitor must be rated over the same operating temperature range as the regulator and the ESR is critical; see curve.

### Ordering Information

Temperature Range	Output Voltage						Package
	5.0	8.0	9.0	10	12	15	
$0^\circ C \leq T_A \leq 125^\circ C$	LM2940CT-5.0 LM2940CS-5.0		LM2940CT-9.0 LM2940CS-9.0		LM2940CT-12 LM2940CS-12	LM2940CT-15 LM2940CS-15	TO-220 TO-263
$-40^\circ C \leq T_A \leq 125^\circ C$	LM2940T-5.0 LM2940S-5.0	LM2940T-8.0 LM2940S-8.0	LM2940T-9.0 LM2940S-9.0	LM2940T-10 LM2940S-10	LM2940T-12 LM2940S-12		TO-220 TO-263
$-55^\circ C \leq T_A \leq 125^\circ C$	LM2940K-5.0/883	LM2940K-8.0/883			LM2940K-12/883	LM2940K-15/883	TO-3

## Absolute Maximum Ratings (Note 1)

If Military/Aerospace specified devices are required, please contact the National Semiconductor Sales Office/Distributors for availability and specifications. (Note 2)

LM2940S, T ≤ 100 ms	60V
LM2940T, T ≤ 100 ms	60V
LM2940K/883, T ≤ 20 ms	40V
LM2940CT, T ≤ 1 ms	45V
LM2940CS, T ≤ 1 ms	45V
Internal Power Dissipation (Note 3)	Internally Limited
Maximum Junction Temperature	150°C
Storage Temperature Range	-65°C ≤ T <sub>J</sub> ≤ +150°C

Lead Temperature (Soldering, 10 seconds)	
TO-3 (K) Package	300°C
TO-220 (T) Package	260°C
TO-263 (S) Package	260°C
ESD Susceptibility (Note 4)	2 kV

## Operating Conditions (Note 1)

Input Voltage	26V
Temperature Range	
LM2940K/883	-55°C ≤ T <sub>A</sub> ≤ 125°C
LM2940T, LM2940S	-40°C ≤ T <sub>A</sub> ≤ 125°C
LM2940CT, LM2940CS	0°C ≤ T <sub>A</sub> ≤ 125°C

**Electrical Characteristics** V<sub>IN</sub> = V<sub>O</sub> + 5V, I<sub>O</sub> = 1A, C<sub>O</sub> = 22 μF, unless otherwise specified. **Boldface limits apply over the entire operating temperature range of the indicated device.** All other specifications apply for T<sub>A</sub> = T<sub>J</sub> = 25°C

Output Voltage (V <sub>O</sub> )		5V			8V			Units
Parameter	Conditions	Typ	LM2940 Limit (Note 5)	LM2940/883 Limit (Note 6)	Typ	LM2940 Limit (Note 5)	LM2940/883 Limit (Note 6)	
Output Voltage	5 mA ≤ I <sub>O</sub> ≤ 1A	5.00	6.25V ≤ V <sub>IN</sub> ≤ 26V		9.4V ≤ V <sub>IN</sub> ≤ 26V		V <sub>MIN</sub> V <sub>MAX</sub>	
			4.85/ <b>4.75</b> 5.15/ <b>5.25</b>	4.85/ <b>4.75</b> 5.15/ <b>5.25</b>	8.00	7.76/ <b>7.60</b> 8.24/ <b>8.40</b>		7.76/ <b>7.60</b> 8.24/ <b>8.40</b>
Line Regulation	V <sub>O</sub> + 2V ≤ V <sub>IN</sub> ≤ 26V, I <sub>O</sub> = 5 mA	20	50	40/ <b>50</b>	20	80	50/ <b>80</b>	mV <sub>MAX</sub>
Load Regulation	50 mA ≤ I <sub>O</sub> ≤ 1A LM2940, LM2940/883 LM2940C	35	50/ <b>80</b>	50/ <b>100</b>	55	80/ <b>130</b>	80/ <b>130</b>	mV <sub>MAX</sub>
		35	50		55	80		
Output Impedance	100 mADC and 20 mArms, f <sub>O</sub> = 120 Hz	35		1000/ <b>1000</b>	55		1000/ <b>1000</b>	mΩ
Quiescent Current	V <sub>O</sub> + 2V ≤ V <sub>IN</sub> ≤ 26V, I <sub>O</sub> = 5 mA LM2940, LM2940/883 LM2940C	10	15/ <b>20</b>	15/ <b>20</b>	10	15/ <b>20</b>	15/ <b>20</b>	mA <sub>MAX</sub>
		10	15		10			
	V <sub>IN</sub> = V <sub>O</sub> + 5V, I <sub>O</sub> = 1A	30	45/ <b>60</b>	50/ <b>60</b>	30	45/ <b>60</b>	50/ <b>60</b>	mA <sub>MAX</sub>
Output Noise Voltage	10 Hz – 100 kHz, I <sub>O</sub> = 5 mA	150		700/ <b>700</b>	240		1000/ <b>1000</b>	μV <sub>rms</sub>
Ripple Rejection	f <sub>O</sub> = 120 Hz, 1 V <sub>rms</sub> , I <sub>O</sub> = 100 mA LM2940 LM2940C	72	60/ <b>54</b>		66	54/ <b>48</b>		dB <sub>MIN</sub>
		72	60		66	54		
	f <sub>O</sub> = 1 kHz, 1 V <sub>rms</sub> , I <sub>O</sub> = 5 mA			60/ <b>50</b>			54/ <b>48</b>	dB <sub>MIN</sub>
Long Term Stability		20			32			mV/ 1000 Hr
Dropout Voltage	I <sub>O</sub> = 1A	0.5	0.8/ <b>1.0</b>	0.7/ <b>1.0</b>	0.5	0.8/ <b>1.0</b>	0.7/ <b>1.0</b>	V <sub>MAX</sub>
	I <sub>O</sub> = 100 mA	110	150/ <b>200</b>	150/ <b>200</b>	110	150/ <b>200</b>	150/ <b>200</b>	mV <sub>MAX</sub>

**Electrical Characteristics**  $V_{IN} = V_O + 5V$ ,  $I_O = 1A$ ,  $C_O = 22 \mu F$ , unless otherwise specified. **Boldface limits apply over the entire operating temperature range of the indicated device.** All other specifications apply for  $T_A = T_J = 25^\circ C$  (Continued)

Output Voltage ( $V_O$ )		5V			8V			Units
Parameter	Conditions	Typ	LM2940 Limit (Note 5)	LM2940/883 Limit (Note 6)	Typ	LM2940 Limit (Note 5)	LM2940/883 Limit (Note 6)	
Short Circuit Current	(Note 7)	1.9	1.6	1.5/ <b>1.3</b>	1.9	1.6	1.6/ <b>1.3</b>	$A_{MIN}$
Maximum Line Transient	$R_O = 100\Omega$ LM2940, $T \leq 100$ ms LM2940/883, $T \leq 20$ ms LM2940C, $T \leq 1$ ms	75	60/ <b>60</b>		75	60/ <b>60</b>		$V_{MIN}$
		55	45	40/ <b>40</b>	55	45	40/ <b>40</b>	
Reverse Polarity DC Input Voltage	$R_O = 100\Omega$ LM2940, LM2940/883 LM2940C	-30	-15/ - <b>15</b>	-15/ - <b>15</b>	-30	-15/ - <b>15</b>	-15/ - <b>15</b>	$V_{MIN}$
		-30	-15		-30	-15		
Reverse Polarity Transient Input Voltage	$R_O = 100\Omega$ LM2940, $T \leq 100$ ms LM2940/883, $T \leq 20$ ms LM2940C, $T \leq 1$ ms	-75	-50/ - <b>50</b>		-75	-50/ - <b>50</b>		$V_{MIN}$
		-55	-45/ - <b>45</b>	-45/ - <b>45</b>			-45/ - <b>45</b>	

**Electrical Characteristics**  $V_{IN} = V_O + 5V$ ,  $I_O = 1A$ ,  $C_O = 22 \mu F$ , unless otherwise specified. **Boldface limits apply over the entire operating temperature range of the indicated device.** All other specifications apply for  $T_A = T_J = 25^\circ C$  (Continued)

Output Voltage ( $V_O$ )		9V		10V		Units
Parameter	Conditions	Typ	LM2940 Limit (Note 5)	Typ	LM2940 Limit (Note 5)	
Output Voltage	$5 \text{ mA} \leq I_O \leq 1A$	$10.5V \leq V_{IN} \leq 26V$		$11.5V \leq V_{IN} \leq 26V$		$V_{MIN}$ $V_{MAX}$
		9.00	8.73/ <b>8.55</b> 9.27/ <b>9.45</b>	10.00	9.70/ <b>9.50</b> 10.30/ <b>10.50</b>	
Line Regulation	$V_O + 2V \leq V_{IN} \leq 26V$ , $I_O = 5 \text{ mA}$	20	90	20	100	$\text{mV}_{MAX}$
Load Regulation	$50 \text{ mA} \leq I_O \leq 1A$ LM2940 LM2940C	60	90/ <b>150</b>	65	100/ <b>165</b>	$\text{mV}_{MAX}$
		60	90			
Output Impedance	100 mADC and 20 mArms, $f_O = 120 \text{ Hz}$	60		65		$\text{m}\Omega$
Quiescent Current	$V_O + 2V \leq V_{IN} < 26V$ , $I_O = 5 \text{ mA}$ LM2940 LM2940C	10 10	15/ <b>20</b> 15	10	15/ <b>20</b>	$\text{mA}_{MAX}$
	$V_{IN} = V_O + 5V$ , $I_O = 1A$	30	45/ <b>60</b>	30	45/ <b>60</b>	$\text{mA}_{MAX}$
Output Noise Voltage	10 Hz – 100 kHz, $I_O = 5 \text{ mA}$	270		300		$\mu V_{rms}$
Ripple Rejection	$f_O = 120 \text{ Hz}$ , $1 V_{rms}$ , $I_O = 100 \text{ mA}$ LM2940 LM2940C	64	52/ <b>46</b>	63	51/ <b>45</b>	$\text{dB}_{MIN}$
		64	52			
Long Term Stability		34		36		$\text{mV}/$ 1000 Hr
Dropout Voltage	$I_O = 1A$	0.5	0.8/ <b>1.0</b>	0.5	0.8/ <b>1.0</b>	$V_{MAX}$
	$I_O = 100 \text{ mA}$	110	150/ <b>200</b>	110	150/ <b>200</b>	$\text{mV}_{MAX}$
Short Circuit Current	(Note 7)	1.9	1.6	1.9	1.6	$A_{MIN}$
Maximum Line Transient	$R_O = 100\Omega$ $T \leq 100 \text{ ms}$ LM2940 LM2940C	75	60/ <b>60</b>	75	60/ <b>60</b>	$V_{MIN}$
		55	45			
Reverse Polarity DC Input Voltage	$R_O = 100\Omega$ LM2940 LM2940C	-30 -30	-15/- <b>15</b> -15	-30	-15/- <b>15</b>	$V_{MIN}$
Reverse Polarity Transient Input Voltage	$R_O = 100\Omega$ $T \leq 100 \text{ ms}$ LM2940 LM2940C	-75 -55	-50/- <b>50</b> -45/- <b>45</b>	-75	-50/- <b>50</b>	$V_{MIN}$

**Electrical Characteristics**  $V_{IN} = V_O + 5V$ ,  $I_O = 1A$ ,  $C_O = 22 \mu F$ , unless otherwise specified. **Boldface limits apply over the entire operating temperature range of the indicated device.** All other specifications apply for  $T_A = T_J = 25^\circ C$  (Continued)

Output Voltage ( $V_O$ )		12V			15V			Units
Parameter	Conditions	Typ	LM2940 Limit (Note 5)	LM2940/833 Limit (Note 6)	Typ	LM2940 Limit (Note 5)	LM2940/833 Limit (Note 6)	
Output Voltage	$5 \text{ mA} \leq I_O \leq 1A$	$13.6V \leq V_{IN} \leq 26V$			$16.75V \leq V_{IN} \leq 26V$			$V_{MIN}$ $V_{MAX}$
		12.00	11.64/ <b>11.40</b> 12.36/ <b>12.60</b>	11.64/ <b>11.40</b> 12.36/ <b>12.60</b>	15.00	14.55/ <b>14.25</b> 15.45/ <b>15.75</b>	14.55/ <b>14.25</b> 15.45/ <b>15.75</b>	
Line Regulation	$V_O + 2V \leq V_{IN} \leq 26V$ , $I_O = 5 \text{ mA}$	20	120	75/ <b>120</b>	20	150	95/ <b>150</b>	$mV_{MAX}$
Load Regulation	$50 \text{ mA} \leq I_O \leq 1A$ LM2940, LM2940/883 LM2940C	55	120/ <b>200</b>	120/ <b>190</b>	70	150	150/ <b>240</b>	$mV_{MAX}$
		55	120	120				
Output Impedance	100 mADC and 20 mArms, $f_O = 120 \text{ Hz}$	80		1000/ <b>1000</b>	100		1000/ <b>1000</b>	$m\Omega$
Quiescent Current	$V_O + 2V \leq V_{IN} \leq 26V$ , $I_O = 5 \text{ mA}$ LM2940, LM2940/883 LM2940C	10	15/ <b>20</b>	15/ <b>20</b>	10	15	15/ <b>20</b>	$mA_{MAX}$
		10	15	15				
	$V_{IN} = V_O + 5V$ , $I_O = 1A$	30	45/ <b>60</b>	50/ <b>60</b>	30	45/ <b>60</b>	50/ <b>60</b>	$mA_{MAX}$
Output Noise Voltage	10 Hz – 100 kHz, $I_O = 5 \text{ mA}$	360		1000/ <b>1000</b>	450		1000/ <b>1000</b>	$\mu V_{rms}$
Ripple Rejection	$f_O = 120 \text{ Hz}$ , $1 V_{rms}$ , $I_O = 100 \text{ mA}$ LM2940 LM2940C	66	54/ <b>48</b>		64	52		$dB_{MIN}$
		66	54					
	$f_O = 1 \text{ kHz}$ , $1 V_{rms}$ , $I_O = 5 \text{ mA}$			52/ <b>46</b>			48/ <b>42</b>	$dB_{MIN}$
Long Term Stability		48			60			$mV/$ 1000 Hr
Dropout Voltage	$I_O = 1A$	0.5	0.8/ <b>1.0</b>	0.7/ <b>1.0</b>	0.5	0.8/ <b>1.0</b>	0.7/ <b>1.0</b>	$V_{MAX}$
	$I_O = 100 \text{ mA}$	110	150/ <b>200</b>	150/ <b>200</b>	110	150/ <b>200</b>	150/ <b>200</b>	$mV_{MAX}$
Short Circuit Current	(Note 7)	1.9	1.6	1.6/ <b>1.3</b>	1.9	1.6	1.6/ <b>1.3</b>	$A_{MIN}$
Maximum Line Transient	$R_O = 100\Omega$ LM2940, $T \leq 100 \text{ ms}$ LM2940/883, $T \leq 20 \text{ ms}$ LM2940C, $T \leq 1 \text{ ms}$	75	60/ <b>60</b>		55	45	40/ <b>40</b>	$V_{MIN}$
				40/ <b>40</b>				
		55	45	45				
Reverse Polarity DC Input Voltage	$R_O = 100\Omega$ LM2940, LM2940/883 LM2940C	-30 -30	-15/- <b>15</b> -15	-15/- <b>15</b>	-30	-15	-15/- <b>15</b>	$V_{MIN}$
Reverse Polarity Transient Input Voltage	$R_O = 100\Omega$ LM2940, $T \leq 100 \text{ ms}$ LM2940/883, $T \leq 20 \text{ ms}$ LM2940C, $T \leq 1 \text{ ms}$	-75	-50/- <b>50</b>		-55	-45/- <b>45</b>	-45/- <b>45</b>	$V_{MIN}$
				-45/- <b>45</b>				
		-55	-45/- <b>45</b>	-45/- <b>45</b>				

**Note 1:** Absolute Maximum Ratings are limits beyond which damage to the device may occur. Operating Conditions are conditions under which the device functions but the specifications might not be guaranteed. For guaranteed specifications and test conditions see the Electrical Characteristics.

**Note 2:** Military specifications complied with RETS/SMD at the time of printing. For current specifications refer to RETS LM2940K-5.0, LM2940K-8.0, LM2940K-12, and LM2940K-15. SMD numbers are 5962-8958701YA(5V), 5962-9083301YA(8V), 5962-9088401YA(12V), and 5962-9088501YA(15V).

**Note 3:** The maximum power dissipation is a function of the maximum junction temperature,  $T_J = 150^\circ\text{C}$ , the junction-to-ambient thermal resistance,  $\theta_{JA}$ , and the ambient temperature,  $T_A$ . The maximum allowable power dissipation at any ambient temperature is  $P_{D\text{MAX}} = (150 - T_A)/\theta_{JA}$ . If this dissipation is exceeded, the die temperature will rise above  $150^\circ\text{C}$  and the LM2940 will go into thermal shutdown. For the LM2940T and LM2940CT, the junction-to-ambient thermal resistance ( $\theta_{JA}$ ) is  $53^\circ\text{C/W}$ . When using a heatsink,  $\theta_{JA}$  is the sum of the  $3^\circ\text{C/W}$  junction-to-case thermal resistance ( $\theta_{JC}$ ) of the LM2940T or LM2940CT and the case-to-ambient thermal resistance of the heatsink. If the TO-263 package is used, the thermal resistance can be used by increasing the P.C. board copper area thermally connected to the package. Using 0.5 square inches of copper area,  $\theta_{JA}$  is  $50^\circ\text{C/W}$ ; with 1 square inch of copper area,  $\theta_{JA}$  is  $37^\circ\text{C/W}$ ; and with 1.6 or more square inches of copper area,  $\theta_{JA}$  is  $32^\circ\text{C/W}$ . For the LM2940K,  $\theta_{JA}$  is  $39^\circ\text{C/W}$  and  $\theta_{JC}$  is  $4^\circ\text{C/W}$ .

**Note 4:** ESD rating is based on the human body model, 100 pF discharged through 1.5 k $\Omega$ .

**Note 5:** All limits are guaranteed at  $T_A = T_J = 25^\circ\text{C}$  only (standard typeface) or over the entire operating temperature range of the indicated device (**boldface type**). All limits at  $T_A = T_J = 25^\circ\text{C}$  are 100% production tested. All limits at temperature extremes are guaranteed via correlation using standard Statistical Quality Control methods.

**Note 6:** All limits are guaranteed at  $T_A = T_J = 25^\circ\text{C}$  only (standard typeface) or over the entire operating temperature range of the indicated device (**boldface type**). All limits are 100% production tested and are used to calculate Outgoing Quality Levels.

**Note 7:** Output current will decrease with increasing temperature but will not drop below 1A at the maximum specified temperature.

## Typical Performance Characteristics

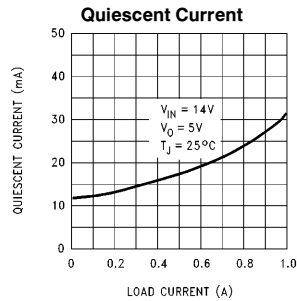
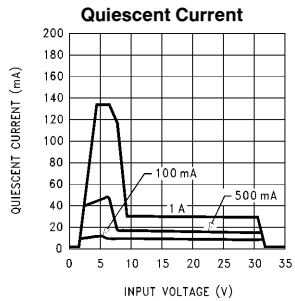
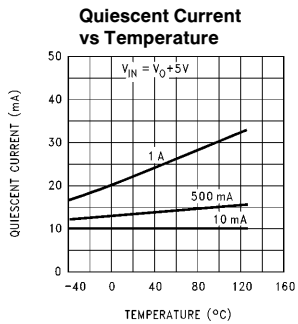
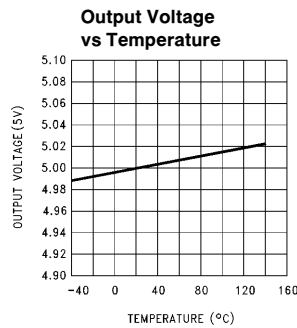
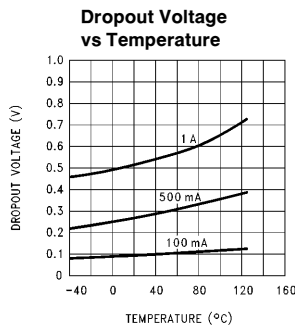
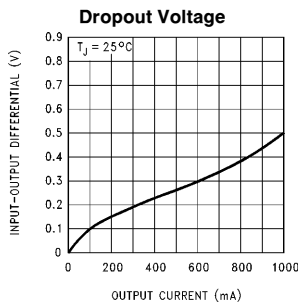

TL/H/8822-9

## Typical Performance Characteristics (Continued)

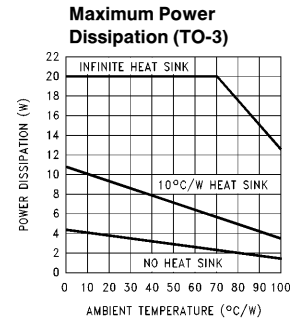
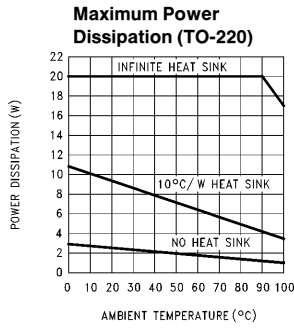
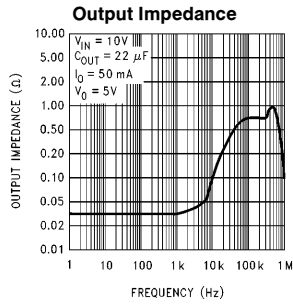
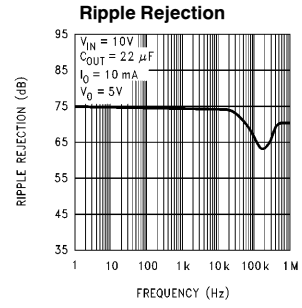
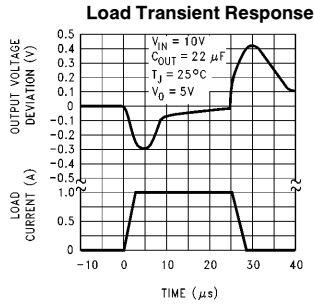
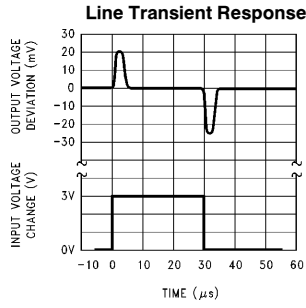

TL/H/8822-4

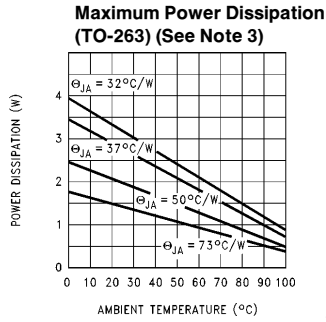

TL/H/8822-10



# Typical Performance Characteristics (Continued)

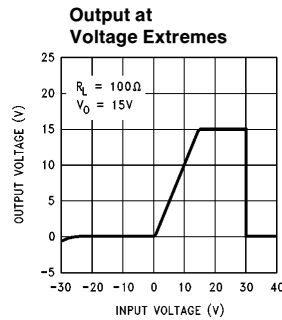
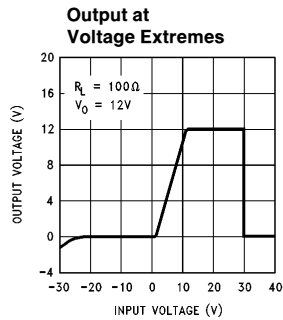
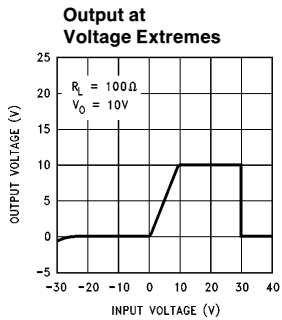
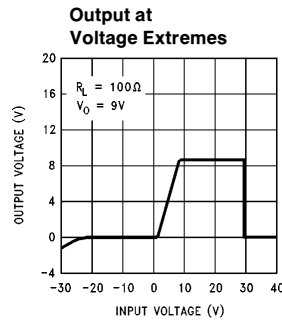
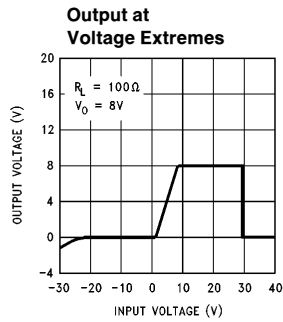
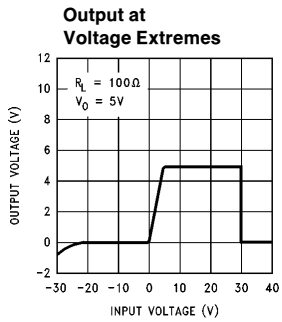
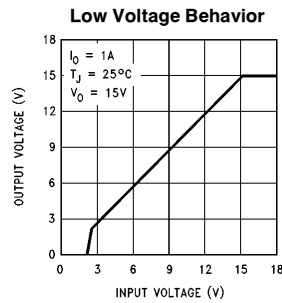
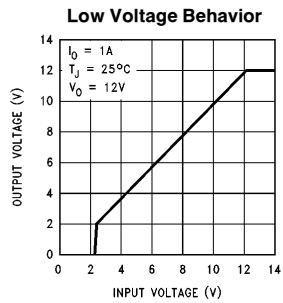
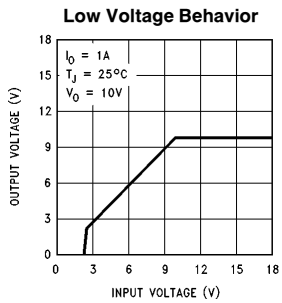
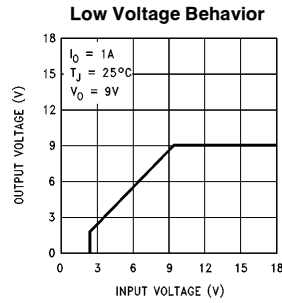
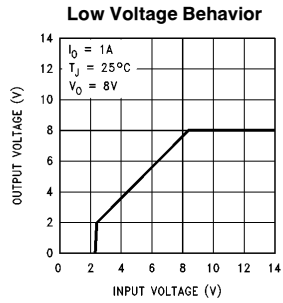
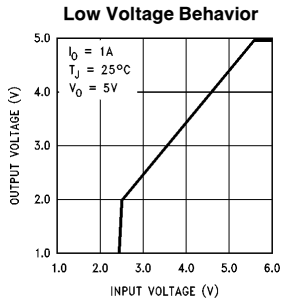

TL/H/8822-5

## Typical Performance Characteristics (Continued)

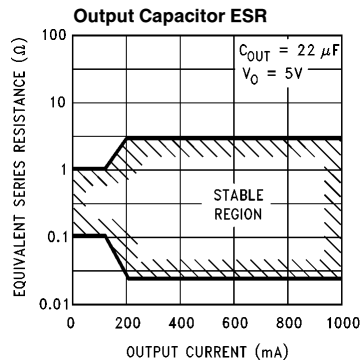

TL/H/8822-6

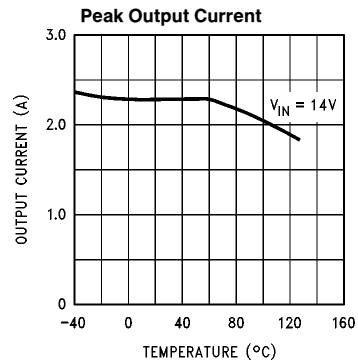

TL/H/8822-8

## Equivalent Schematic Diagram

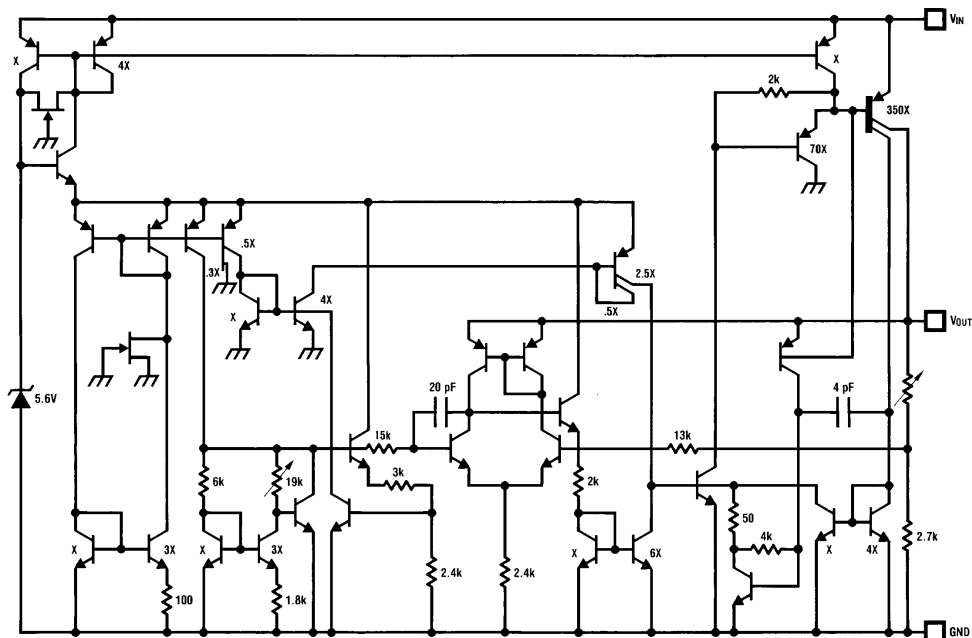

TL/H/8822-1

## Connection Diagrams

(TO-220) Plastic Package

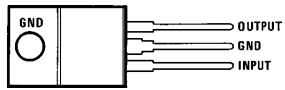

Front View

TL/H/8822-2

Order Number LM2940CT-5.0, LM2940CT-9.0,  
LM2940CT-12, LM2940CT-15, LM2940T-5.0,  
LM2940T-8.0, LM2940T-9.0,  
LM2940T-10 or LM2940T-12  
See NS Package Number TO3B

TO-3 Metal Can Package (K)

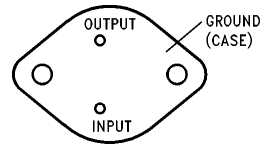

Bottom View

TL/H/8822-7

Order Number LM2940K-5.0/883,  
LM2940K-8.0/883, LM2940K-12/883, LM2940K-15/883  
See NS Package Number K02A

(TO-263) Surface-Mount Package

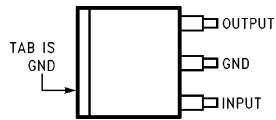

Top View

TL/H/8822-11



Side View

TL/H/8822-12

Order Number LM2940CS-5.0, LM2940CS-9.0, LM2940CS-12,  
LM2940CS-15, LM2940S-5.0, LM2940S-8.0,  
LM2940S-9.0, LM2940S-10 or LM2940S-12  
See NS Package Number TS3B

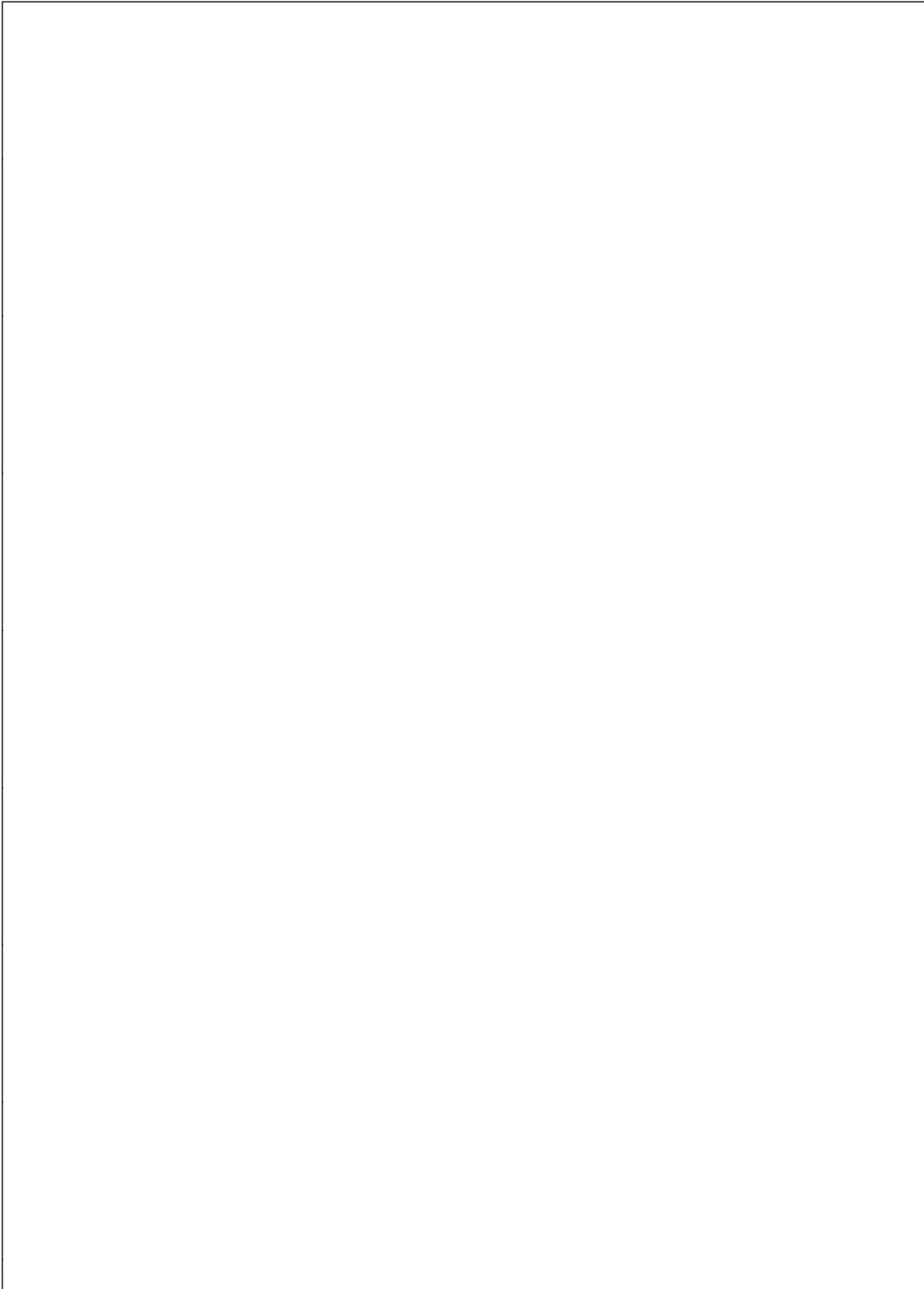

**Physical Dimensions** inches (millimeters) unless otherwise noted

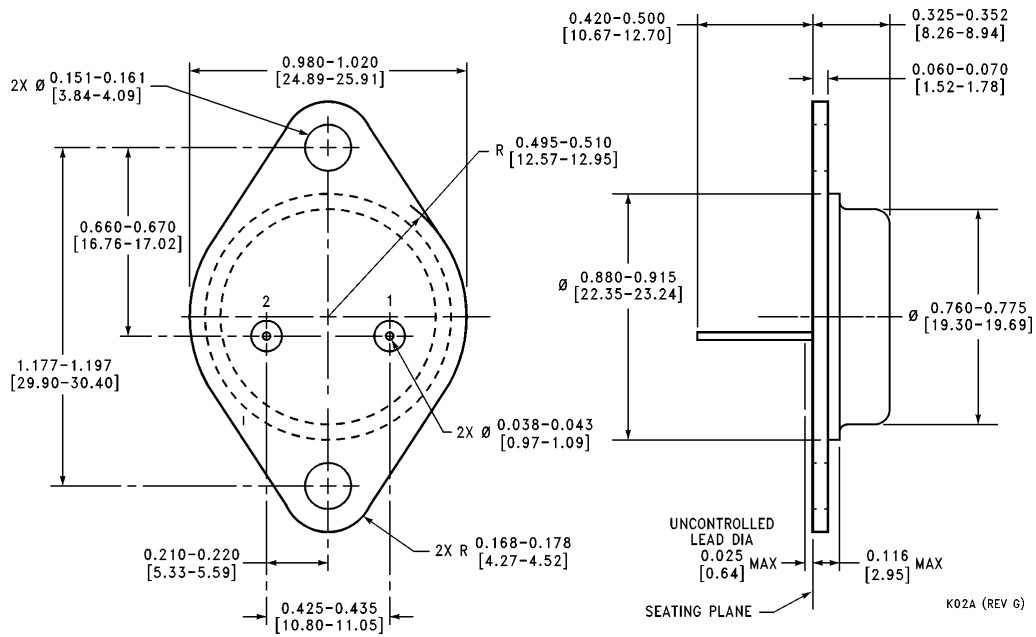

**2 Lead TO-3 Metal Can Package (K)**  
**Order Number LM2940K-5.0/883,**  
**LM2940K-8.0/883, LM2940K-12/883, LM2940K-15/883**  
**NS Package Number K02A**

**Physical Dimensions** inches (millimeters) unless otherwise noted (Continued)

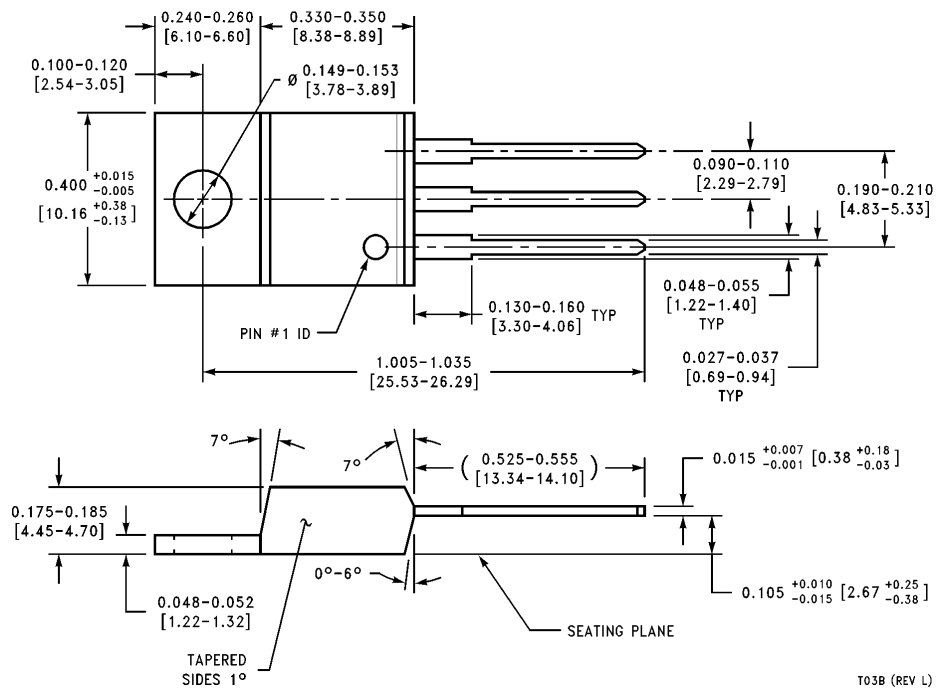

TO3B (REV L)

**3-Lead TO-220 Plastic Package (T)**  
**Order Number LM2940T-5.0, LM2940T-8.0,**  
**LM2940T-9.0, LM2940T-10, LM2940T-12, LM2940CT-5.0,**  
**LM2940CT-12 or LM2940CT-15**  
**NS Package Number TO3B**

**Physical Dimensions** inches (millimeters) unless otherwise noted (Continued)

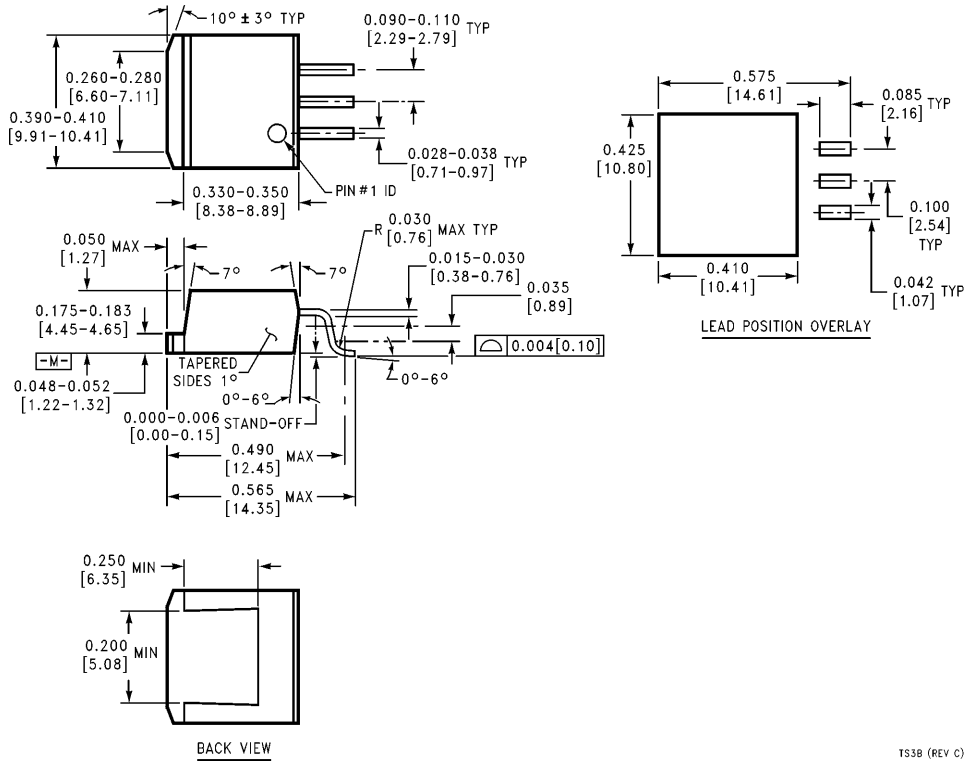

TS3B (REV C)

**3-Lead TO-263 Surface Mount Package**  
**Order Number LM2940S-5.0, LM2940S-8.0,**  
**LM2940S-9.0, LM2940S-10, LM2940S-12,**  
**LM2940CS-5.0, LM2940CS-12 or LM2940CS-15**  
**NS Package Number TS3B**

**LIFE SUPPORT POLICY**

NATIONAL'S PRODUCTS ARE NOT AUTHORIZED FOR USE AS CRITICAL COMPONENTS IN LIFE SUPPORT DEVICES OR SYSTEMS WITHOUT THE EXPRESS WRITTEN APPROVAL OF THE PRESIDENT OF NATIONAL SEMICONDUCTOR CORPORATION. As used herein:

1. Life support devices or systems are devices or systems which, (a) are intended for surgical implant into the body, or (b) support or sustain life, and whose failure to perform, when properly used in accordance with instructions for use provided in the labeling, can be reasonably expected to result in a significant injury to the user.
2. A critical component is any component of a life support device or system whose failure to perform can be reasonably expected to cause the failure of the life support device or system, or to affect its safety or effectiveness.



**National Semiconductor Corporation**  
 1111 West Bardin Road  
 Arlington, TX 76017  
 Tel: (800) 272-9959  
 Fax: (800) 737-7018

<http://www.national.com>

**National Semiconductor Europe**

Fax: +49 (0) 180-530 85 86  
 Email: [europe.support@nsc.com](mailto:europe.support@nsc.com)  
 Deutsch Tel: +49 (0) 180-530 85 85  
 English Tel: +49 (0) 180-532 78 32  
 Français Tel: +49 (0) 180-532 93 58  
 Italiano Tel: +49 (0) 180-534 16 80

**National Semiconductor Hong Kong Ltd.**

19th Floor, Straight Block,  
 Ocean Centre, 5 Canton Rd.  
 Tsimshatsui, Kowloon  
 Hong Kong  
 Tel: (852) 2737-1600  
 Fax: (852) 2736-9960

**National Semiconductor Japan Ltd.**

Tel: 81-043-299-2308  
 Fax: 81-043-299-2408