



INSTRUCTIONS FOR:

CAR PORT SHELTER 3 X 5.1 X 2.4M

MODEL NO: **CPS01**

Thank you for purchasing a Sealey product. Manufactured to a high standard, this product will, if used according to these instructions, and properly maintained, give you years of trouble free performance.

IMPORTANT: PLEASE READ THESE INSTRUCTIONS CAREFULLY. NOTE THE SAFE OPERATIONAL REQUIREMENTS, WARNINGS & CAUTIONS. USE THE PRODUCT CORRECTLY AND WITH CARE FOR THE PURPOSE FOR WHICH IT IS INTENDED. FAILURE TO DO SO MAY CAUSE DAMAGE AND/OR PERSONAL INJURY AND WILL INVALIDATE THE WARRANTY. KEEP THESE INSTRUCTIONS SAFE FOR FUTURE USE.

1. SAFETY



Refer to instruction manual



Wear eye protection



Wear protective gloves

- This is a temporary structure and is not recommended as a permanent structure.
- Choose your shelter's location carefully. Check for overhead utility lines, branches, etc. **DO NOT** install near roofs or other structures that may shed snow, ice or excessive run-off onto your shelter. Keep away from electrical wires!
- Have an overview of all parts before attempting installation. Make sure all components are available.
- DO NOT** use this product in environments for which it is not intended (i.e. extreme cold, high winds, extreme heat, heavy rainfall, etc).
- Always wear safety glasses when assembling this product. Wear gloves when working with tubing to prevent cuts or abrasions.
- WARNING!** Anchors must be used with all shelters. Covers should **NOT** be installed until it has been properly anchored to the ground.
- Proper anchoring and keeping cover tight and free of snow and debris, is the responsibility of the consumer. Damages caused by improper anchoring are not covered under warranty.
- WARNING!** Keep all flame and heat sources away from the shelter fabric. The fabric will burn if left in continuous contact with a flame source.
- DO NOT** use open flames or cooking or heating devices inside or in close proximity to the product, including all types of stoves, gas heaters, gas lanterns, citronella torches, mosquito coils, etc.
- WARNING!** In order to reduce risk of burning and avoid damage, **DO NOT**:
 - cook, smoke, refuel or use any open flame devices in or around the shelter.
 - store flammable liquids (gasoline, kerosene, propane, etc.) in the shelter.
 - operate gas powered equipment in or around the shelter.
- Keep open flames a safe distance away from the shelter.
- DO NOT** use hard-edged tools or instruments, such as rakes or shovels, to remove snow. These can cause punctures to the cover.
- NEVER** start the engine of any vehicle or machine inside a closed shelter. Ensure that there is adequate ventilation for starting engines and for any work with paints, cleaners, etc.
- DO NOT** use bleach, alkaline or harsh detergents for cleaning. Doing so will damage the polycarbonate material. Soap and warm water are recommended.
- This temporary shelter is intended to offer protection from damages caused by the sun, light rain, light snow, tree sap, bird and animal excrements. **DO NOT** use it to shield goods from high winds, heavy snow or ice storms. Only use it for its intended use.

2. INTRODUCTION





























Allows for extra space quickly when required, a garage for cars, storage for boats, materials and machinery. Constructed of a Thermoset powder coated finished steel frame work, which is strong and rust resistant with a heavy-duty tarpaulin made of a PE (polyethylene) material of a 3 layer construction with rip stop to help prevent tears. UV resistant and offers long life and good protection to stored items. Included stake pegs secure the shelter against strong winds, a dirt skirt on both sides further protect against crosswinds. A wide opening double zip door, which can be rolled up out of the way, provides easy access.

3. SPECIFICATION

Model No: **CPS01**
Overall Size: 3040 x 5180 x 2430mm

4. ASSEMBLY

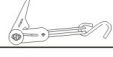
- 4.1. Assembly Preparation**
 - 4.1.1. Place all parts from the packaging box in a cleared area and arrange them on the ground in front of you.
 - 4.1.2. Remove all packaging materials and place them back in the box. **DO NOT** dispose of the packaging materials until assembly is complete.
Check for completeness and transport damages.
 - WARNING! DO NOT** place the product under trees from which hard fruit such as apples, walnuts or heavy pine cones, etc., may fall.
 - 4.1.3. Keep children away during assembly. This product contains small parts which can be swallowed by children.
 - 4.1.4. **DO NOT** attempt to assemble the product if any parts are missing.
 - 4.1.5. At least 3 people are needed to complete the assembly as some of the steps require heavy lifting.
 - WARNING! DO NOT** leave the shelter unattended during assembly. Otherwise, personal injury or damage to the shelter may occur!

Part#	Description	Drawing	Qty.
1	Leg Tube (Top Part)		10
2	Leg Tube (Center Bottom Part)		6
3	Leg Tube (Corner Bottom Part)		4
4	Rafter Tube		10
5	Horizontal Tube		12
6	Bottom Cross Rails		8
7	3-Way Peak Connector		2
8	4-Way Peak Connector		3
9	3-Way Side Connector -Left		2
10	3-Way Side Connector -Right		2
11	4-Way Side Connector		6
12	4-Way Cover Rail Clamp		12
13	Bent Corner Leg		4
14	3-Way Cover Rail Clamp		8
15	15" Anchor		4
16	Foot Plate		6
17	Cable Clamps		4
18	Cable-1" Lengths		4
19	Pin Bolt		6
20	Open Pin		6
21	M6X45 Bolts		16
22	M6 Washer		16
23	M6 Nuts		17
24	Roof Tarp		1
25	Door Panel with Zipper		1
26	Back Panel		1
27	Ratchet		8
#	Owner's Manual		1

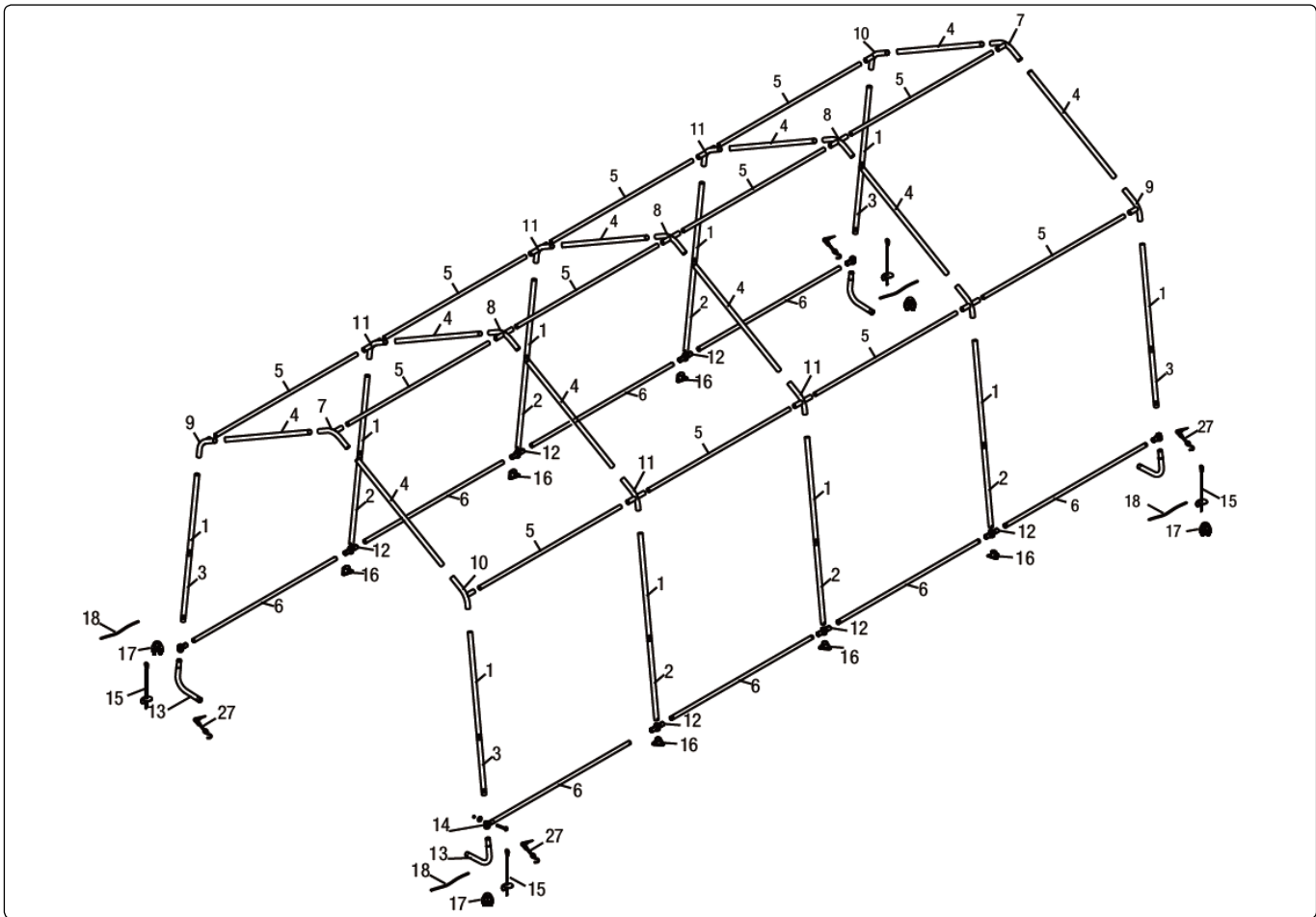
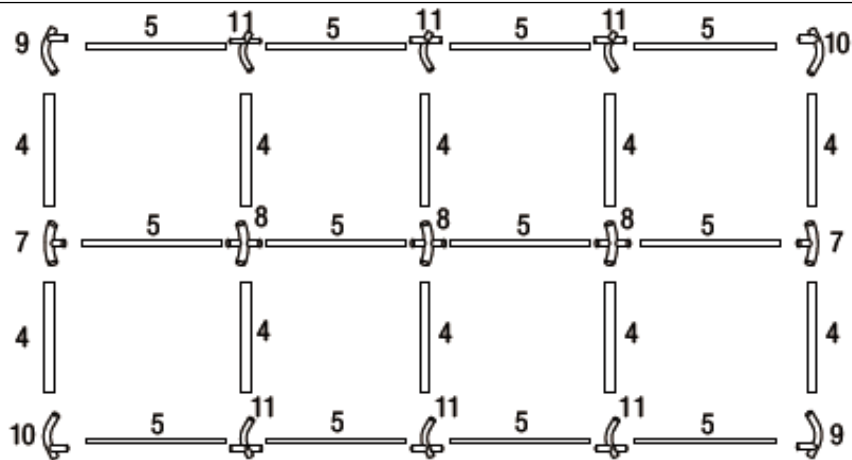

fig.1



4.2. Preparing the Roof Parts

- 4.2.1. Select a level and suitable location for the shelter. Layout the roof parts as as shown in fig.1.
- 4.2.2. Please pay attention to the differences in the 5 connectors as shown in fig.2.

fig.2

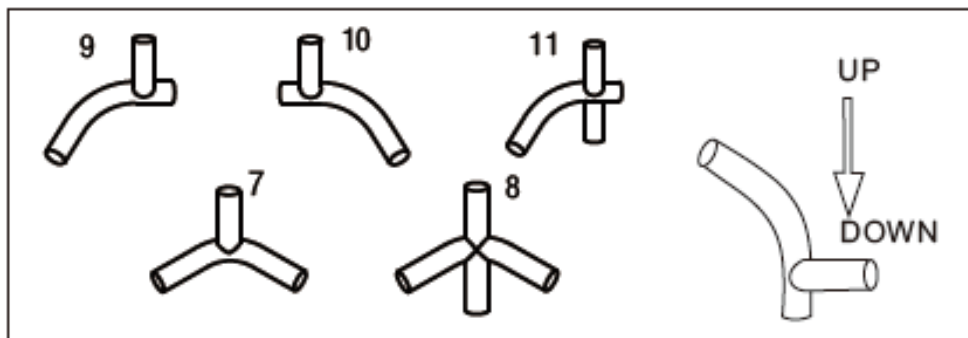

- Note:**
- 1. When installed the welded socket for the cross rail must be below the bend.
 - 2. Parts 9, 10, 11 are side bend connectors with a sharp bend.
 - 3. Parts 7 and 8 are top bend connectors with a sloping bend.

4.3. Assembling the Roof

- 4.3.1. Assemble the roof by connecting the parts as they are laid out in fig.1, see also fig.3.
- 4.3.2. There is a spring button on both ends of part 5. Make sure the button pops up when it is connected to parts 7 and 8. See fig.3.
- 4.3.3. Use a wooden or rubber mallet to make sure all pipes are fully inserted.

fig.3

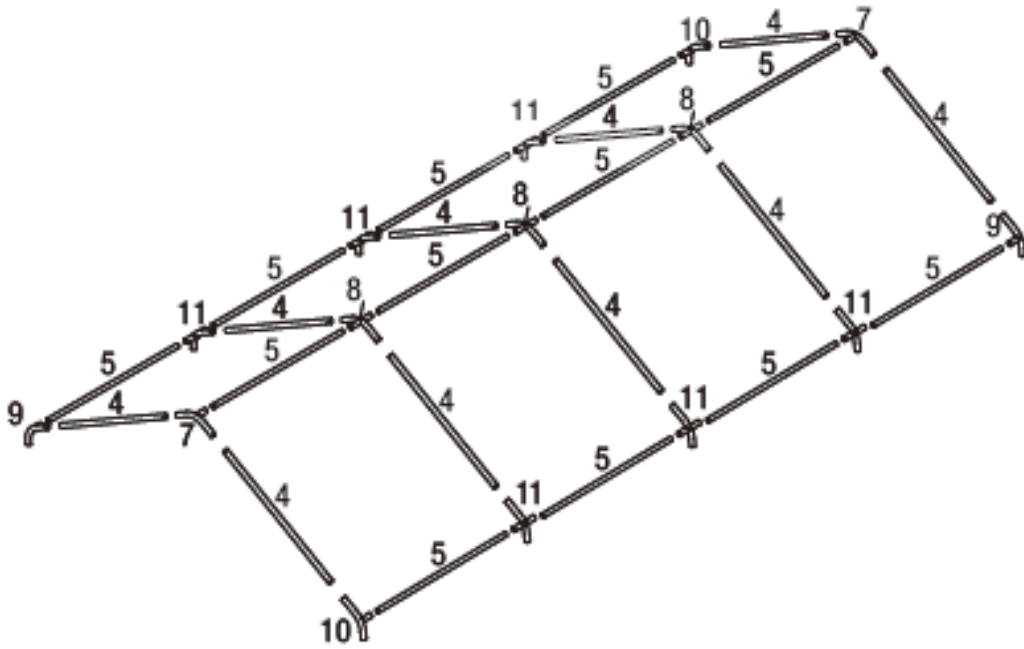

4.4. Attaching the legs

- 4.4.1. There are 10 legs for the whole shelter.
- 4.4.2. Follow fig.4 drawing E1 to connect tube 1, 3 and 13 to get the 4 corner legs.
- 4.4.3. Then connect tubes 1 and 2 to build the 6 centre legs.
- 4.4.4. Insert the centre legs into the foot plates. Align the holes in the poles with the foot plate, push the pin bolt (part 19) through all the holes. Insert the cotter pin (part 20) and split the tongues of the cotter pin with a slot screwdriver to secure this connection. See fig.4 drawings E2, E3 and E4.
- 4.4.5. Insert the prepared centre legs and corner legs into the side connectors, see fig.4 drawing E5.
- 4.4.6. Repeat to assemble the other side as shown in fig.5.

fig.4

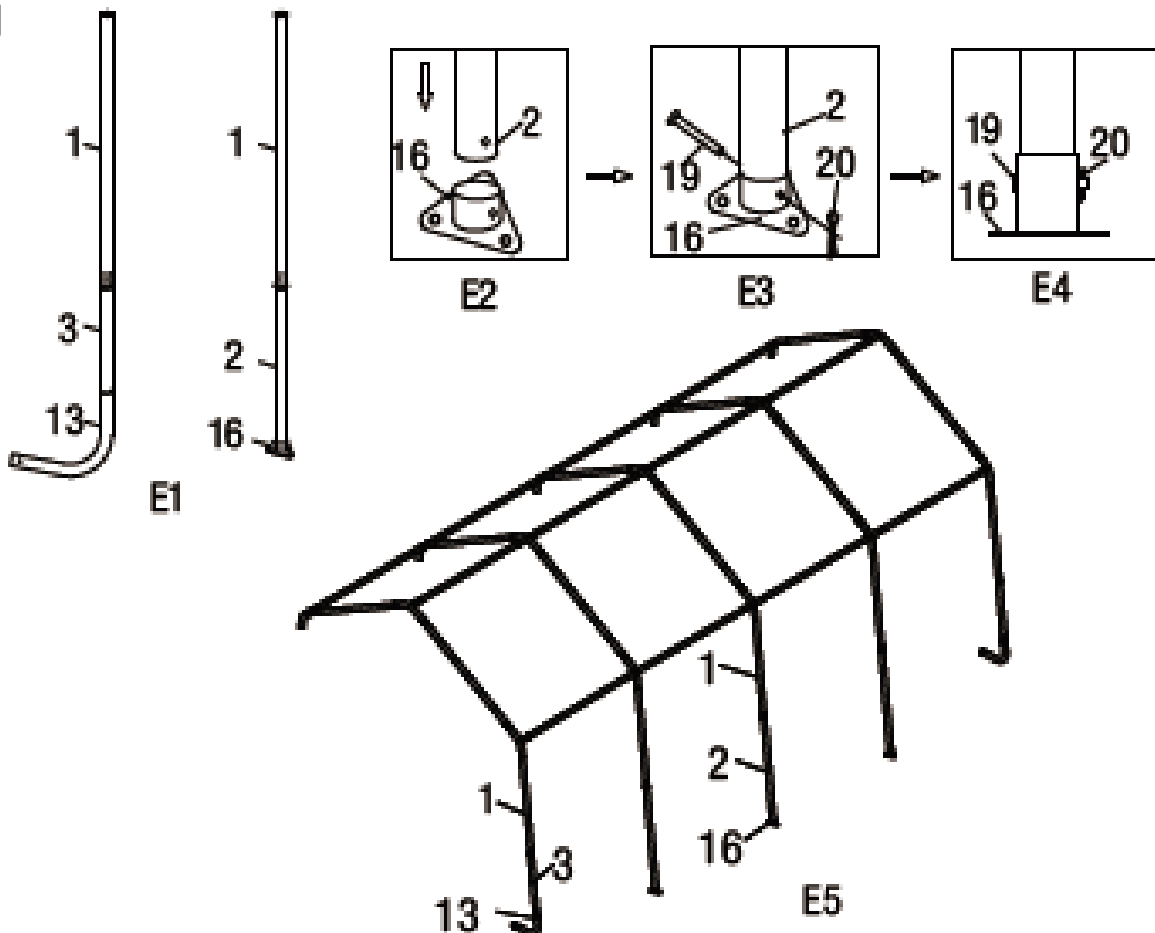
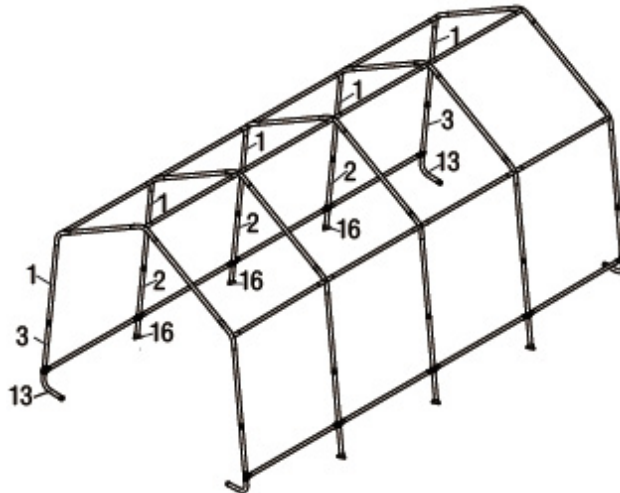

fig.5



4.5. Assemble Bottom Cross Rails

- 4.5.1. Install the bottom cross rails (part 6) between each pair of legs, with cover rail clamps (parts 12 and 14) using fittings 21, 22 and 23. Part 12 is for the centre legs and 14 is for the corner legs, see fig.6.

fig.6

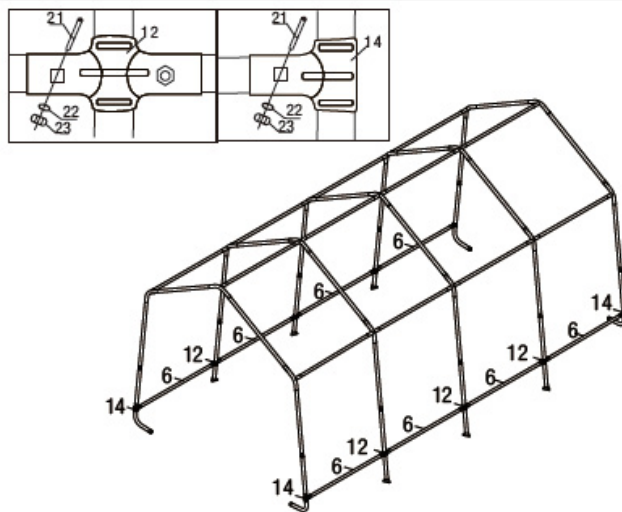

4.6. Square and Anchor the Frames

- 4.6.1. Check the dimensions of the frame. It should be 3m between the front legs, the back legs and across the centre, see fig.7.
- 4.6.2. Take a diagonal measurement as shown in fig.7. When the two diagonals are equal, the frame is square. Adjust the frame until it is equal to within 30mm. Once this is achieved recheck by repeating step 4.6.1.
- 4.6.3. Install anchors (parts 15, 17 and 18) at the 4 corner bent legs, by screwing the removable anchor (part 15) into the ground inside the shelter. Secure with cord (part 18) and clamp (part 17) as shown in fig.8.

fig.7

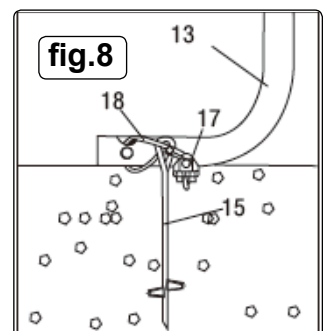
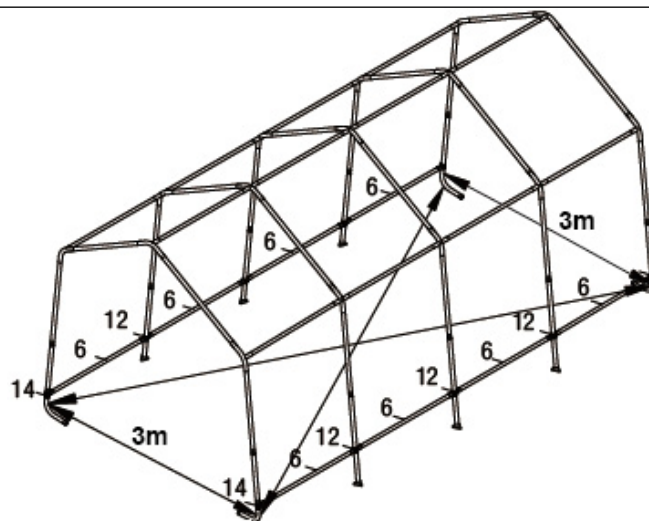

4.7. Installing the Front and Back Covers

- 4.7.1. The front cover contains a zippered door to allow entry and exit to the shelter. Make sure the door is located at the desired end.
- 4.7.2. Make sure the zip is closed during installation.
- 4.7.3. The back cover is a solid piece of polythene. The back and the front covers are installed in the same way.
- 4.7.4. To make sure the strap will stay in the sleeve during assembly, thread through the spindle of the ratchet. Raise and lower the handle two or three times to wind the strap onto the spindle, see fig.9.

fig.9

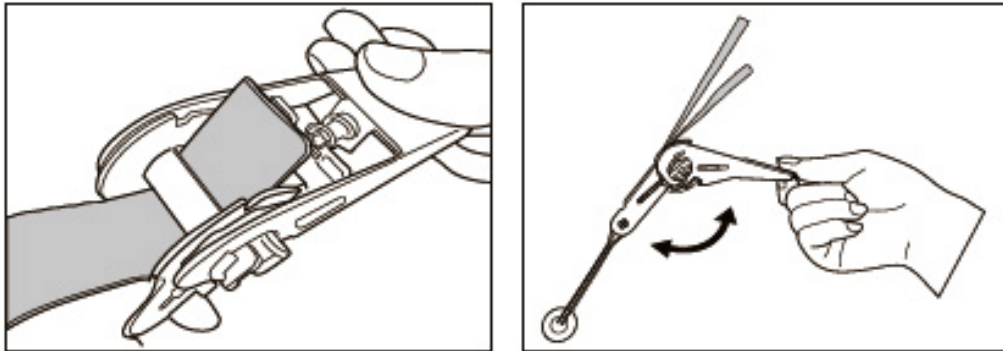

- 4.7.5. Begin with the front cover and first locate the webbed belt that runs the perimeter of the cover. The webbing is exposed at the peak, the shoulders and at the feet of the cover. The webbing has two loose ends. Tie off the two loose ends of the webbed belt, one to each of the two corner legs.
- 4.7.6. Use a rubber mallet to disconnect the shoulder pipe (part 5) from the connector (parts 9 and 10) located between the leg and the roof pipes.
- 4.7.7. Slip the webbed belt between pipe 5 and the connector as shown in fig.10. Rejoin the pipes.
- 4.7.8. Repeat this step for the opposite shoulder.
- 4.7.9. Move to the peak of the shelter. Using a step stool or ladder and a rubber mallet, disconnect the peak pipe (part 5), from the connector (part 7). Slip the webbed belt between the pipes and reconnect.
- 4.7.10. Next insert the S-hook of the ratchet into the hole in the corner leg, and ratchet up/down a couple of times to hold the ratchet and belt in place, see fig.11.
- 4.7.11. Repeat for the other loose end of the webbed belt.
- 4.7.12. While one person remains on the stool, standing at the peak of the shelter, the other person tightens the ratchet, first at the foot of one corner leg and then moving over to the foot of the other corner leg.
- 4.7.13. The person at the peak assists by ensuring the cover is partially folded over the pipes of the end of the frame and inside or toward the interior of the shelter.
- 4.7.14. Ensure the overlap of the cover flap remains square over the end frame and reaches the ground at the base while tightening the ratchets, see fig.12.
- 4.7.15. Repeat the above steps for the other side of the door panel assembly.

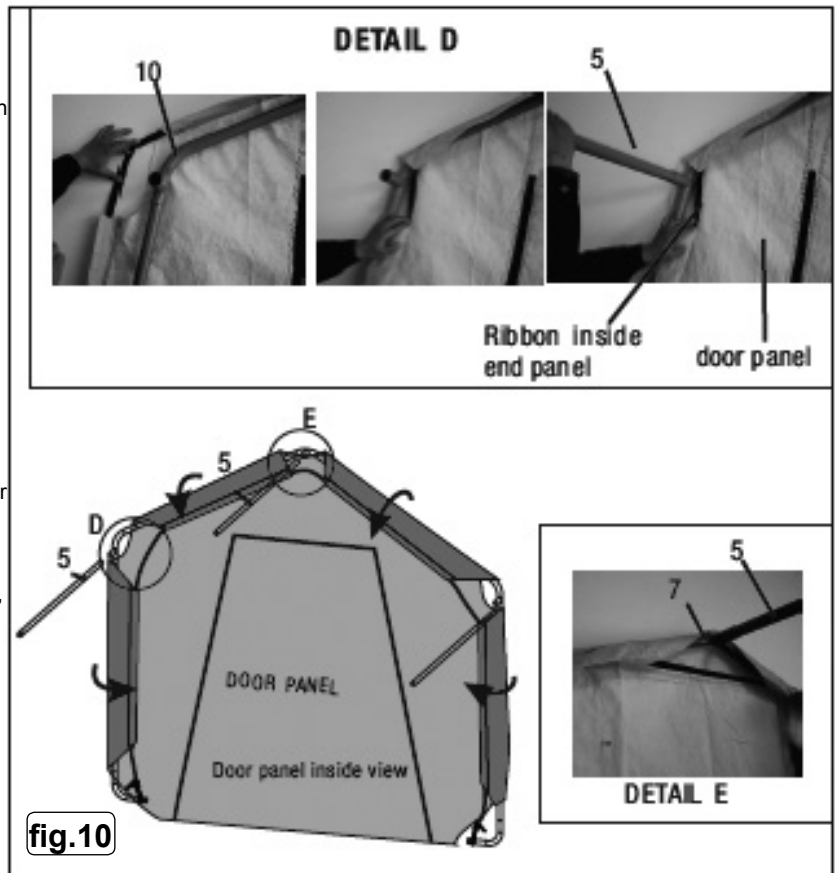
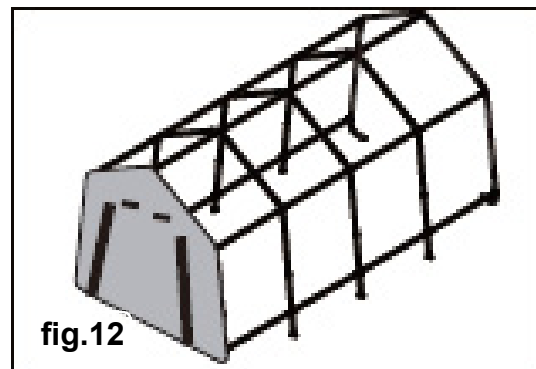
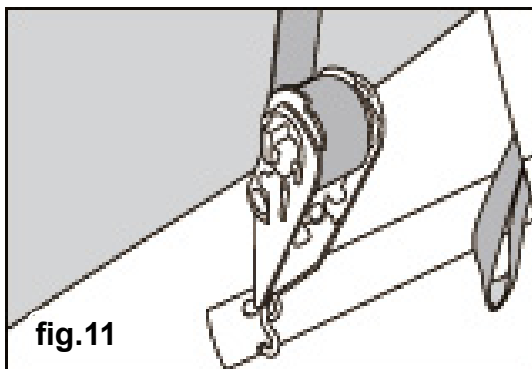

fig.10



4.8. Installing the Main Cover

- 4.8.1. Lay the cover on the ground next to the frame with the inside of the cover (the side with the pipe pockets) facing down and the webbing on the front and rear of the shelter.
- 4.8.2. Tie one end of a rope to the eyelets on one corner of the cover, then another rope to the other corner eyelets.
- 4.8.3. Pull the cover over the frame using the ropes, see fig.13, making sure it is centred over the frame. There should be an equal amount of overhang at all four corners.

fig.13

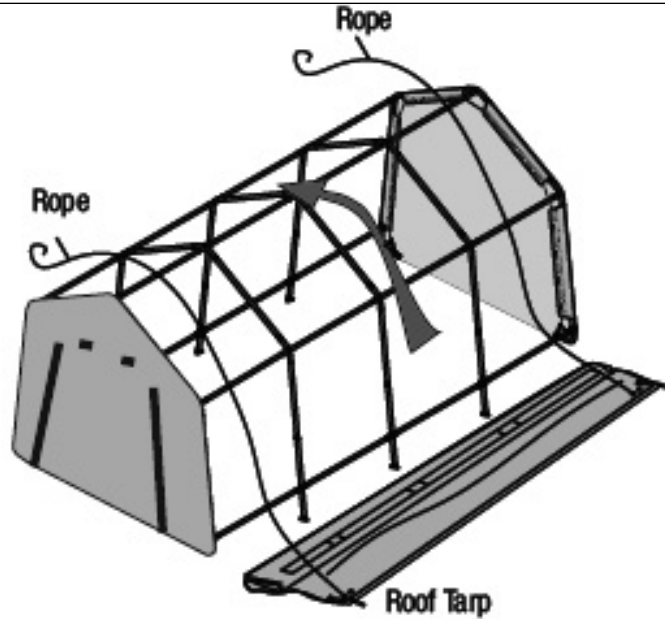

- 4.8.4. Assemble the ratchets (part 27) onto the webbing ends on the 4 corners of the cover. Ratchet a few times to tighten the belt to the ratchet.
- 4.8.5. Insert the S-hook from the ratchet into the hole on the bent corner leg. Wind the ratchet so that the webbing overlaps itself.
- 4.8.6. Disassemble cover rails and slide through the fabric pockets at each leg and reattach with the clamps to each leg. Repeat this on the other side. Push down on the cover rails to tighten the cover, before tightening the bolts completely, see fig.14.

fig.14

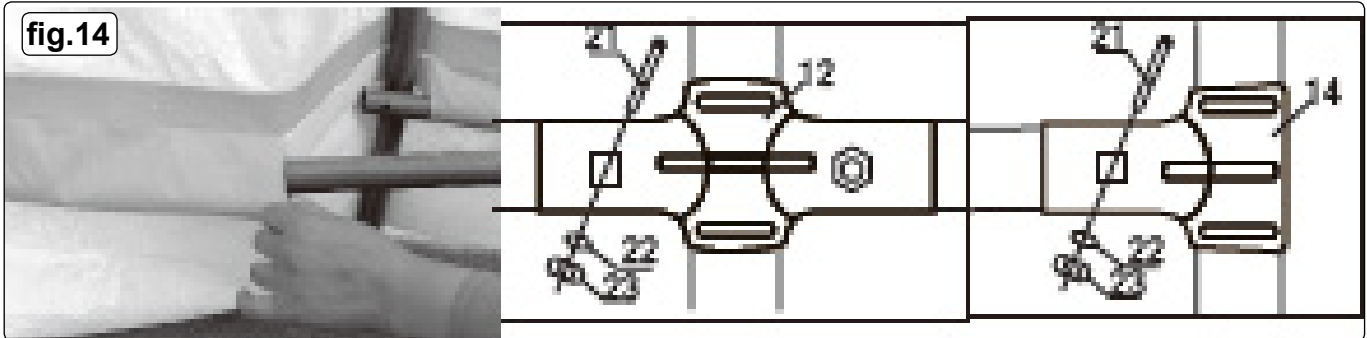

- 4.8.7. When the cover rails are all secured, then proceed to the four corners and tighten the end covers to the end frames using the ratchets.
Note: Over-tightening can cause damage to straps and/or the anchor point **DO NOT** over-tighten.
- 4.8.8. The shelter is now ready for use.
Note: Please check periodically (two to three times in the first week, weekly for the first month of setting up) the tightness of the ratchet tie-downs and all hardware as needed. Monthly inspection is recommended throughout usage.

4.9. Disassembly

- 4.9.1. When disassembling the shelter, depress the spring loaded bar and open the ratchet handle completely to allow the webbed belt to disengage the ratchet, see fig.15.
- 4.9.2. To dismantle, execute all these instructions in reverse order.

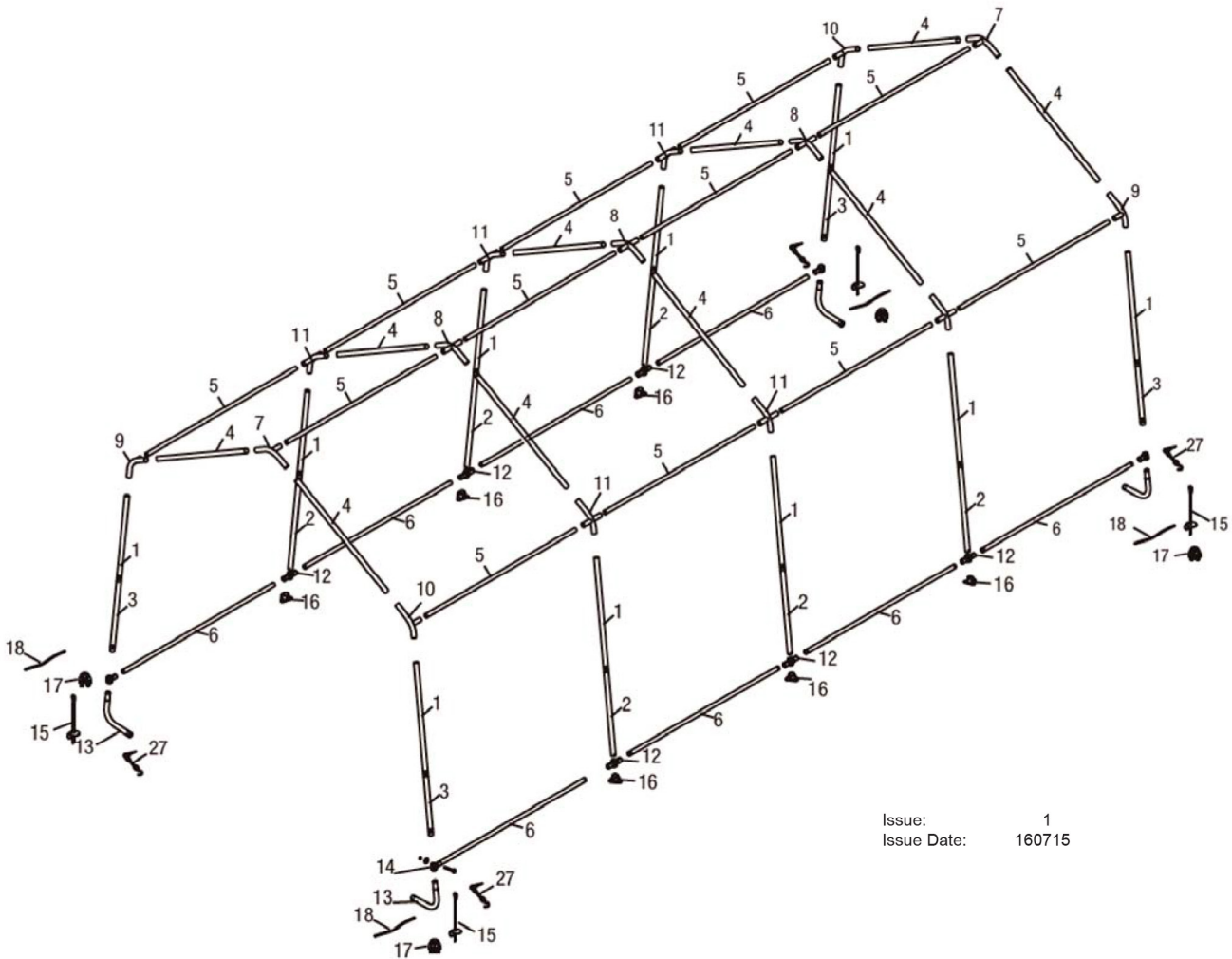

fig.15

5. STORAGE

- 5.1. Store the shelter in a cool, dry location between seasons to prolong usable life of all components.
- 5.2. Components are not equally durable and will replacement over time at differing intervals.

6. PARTS DIAGRAM



Issue: 1
Issue Date: 160715

ITEM	PART NO	DESCRIPTION	ITEM	PART NO	DESCRIPTION
1	CPS01.01	LEG TUBE (TOP PART)	15	CPS01.15	15" ANCHOR
2	CPS01.02	LEG TUBE (CENTRE BOTTOM PART)	16	CPS01.16	FOOT PLATE
3	CPS01.03	LEG TUBE (CORNER BOTTOM PART)	17	CPS01.17	CABLE CLAMPS
4	CPS01.04	RAFTER TUBE	18	CPS01.18	CABLE (12" LENGTH)
5	CPS01.05	HORIZONTAL TUBE	19	CPS01.19	RETAINING PIN (not shown)
6	CPS01.06	BOTTOM CROSS RAILS	20	CPS01.20	SPLIT PIN (not shown)
7	CPS01.07	3-WAY PEAK CONNECTOR	21	CPS01.21	BOLT M6x45 (not shown)
8	CPS01.08	4-WAY PEAK CONNECTOR	22	CPS01.22	WASHER M6 FLAT (not shown)
9	CPS01.09	3-WAY SIDE CONNECTOR - LEFT	23	CPS01.23	NUT M6 (not shown)
10	CPS01.10	3-WAY SIDE CONNECTOR - RIGHT	24	CPS01.24	ROOF TARPULIN (not shown)
11	CPS01.11	4-WAY SIDE CONNECTOR	25	CPS01.25	DOOR PANEL WITH ZIPPER (not shown)
12	CPS01.12	4-WAY COVER RAIL CLAMP	26	CPS01.26	BACK PANEL (not shown)
13	CPS01.13	ANGLED CORNER LEG	27	CPS01.27	RATCHET HOOK
14	CPS01.14	3-WAY COVER RAIL CLAMP			



Environmental Protection

Recycle unwanted materials instead of disposing of them as waste. All tools, accessories and packaging should be sorted, taken to a recycling centre and disposed of in a manner which is compatible with the environment. When the product becomes completely unserviceable and requires disposal, drain off any fluids (if applicable) into approved containers and dispose of the product and the fluids according to local regulations.

NOTE: It is our policy to continually improve products and as such we reserve the right to alter data, specifications and component parts without prior notice.
IMPORTANT: No liability is accepted for incorrect use of this product.

WARRANTY: Guarantee is 12 months from purchase date, proof of which will be required for any claim.



Sole UK Distributor, Sealey Group,
Kempson Way, Suffolk Business Park,
Bury St. Edmunds, Suffolk,
IP32 7AR

01284 757500

01284 703534

www.sealey.co.uk

sales@sealey.co.uk