

# DC POWER SUPPLY

**GPC-M SERIES**  
(ANALOG / DIGITAL TYPE)

82PC-3030CMG

# Safety Terms and Symbols

## Terms in This Manual

These terms may appear in this manual:



**WARNING.** Warning statements identify condition or practices that could result in injury or loss of life.



**CAUTION.** Caution statements identify conditions or practices that could result in damage to this product or other property.

## Terms on the Product

**DANGER** indicates an injury hazard immediately accessible as you read the marking.

**WARNING** indicates an injury hazard not immediately accessible as you read the marking.

**CAUTION** indicates a hazard to property including the product.

## Symbols on the Product

The following symbols may appear on the product:



**DANGER**  
High Voltage



Protective Ground  
(Earth) Terminal



**ATTENTION**  
refer to  
Manual



Double  
Insulated



**DANGER**  
Hot Surface



Functional  
earth terminal

## FOR UNITED KINGDOM

### NOTE

This lead/appliance must only be wired by competent persons

**WARNING**  
**THIS APPLIANCE MUST BE**  
**EARTHED**  
**IMPORTANT**

The wires in this lead are coloured in accordance with the following code:

Green/  
Yellow: Earth  
Blue: Neutral  
Brown: Live (Phase)



As the colours of the wires in mains leads may not correspond with the colours markings identified in your plug/appliance, proceed as follows:-

The wire which is coloured Green & Yellow must be connected to the Earth terminal marked with the letter E or by the earth symbol  $\oplus$  or coloured Green or Green & Yellow.

The wire which is coloured Blue must be connected to the terminal which is marked with the letter N or coloured Blue or Black.

The wire which is coloured Brown must be connected to the terminal marked with the letter L or P or coloured Brown or Red.

If in doubt, consult the instructions provided with the equipment or contact the supplier.

This cable/appliance should be protected by a suitably rated and approved HBC mains fuse; refer to the rating information on the equipment and/or user instructions for details. As a guide, cable of 0.75mm<sup>2</sup>, should be protected by a 3A or 5A fuse. Larger conductors would normally require 13A types, depending on the connection method used.

Any moulded mains connector that requires removal/replacement must be destroyed by removal of any fuse & fuse carrier and disposed of immediately, as a plug with bared wires is hazardous if engaged in a live socket. Any re-wiring must be carried out in accordance with the information detailed on this label.

# CONTENTS

SECTION	PAGE
1. INTRODUCTION .....	1
2. SPECIFICATIONS .....	2
2-1 General .....	2
2-2 Operation Mode .....	3
2-3 Constant Voltage Operation .....	3
2-4 Constant Current Operation .....	3
2-5 Tracking Operation .....	3
2-6 Meter .....	4
2-7 5V Output Specifications .....	4
2-8 Insulation .....	4
3. THEORY OF OPERATION .....	4
4. PANEL CONTROLS AND INDICATORS .....	7
4-1 Front Panel .....	10
4-2 Rear Panel .....	11
5. OPERATION INSTRUCTIONS .....	12
5-1 Precaution .....	12
5-2 Setting Current Limit .....	12
5-3 Constant Voltage/Constant Current Characteristic .....	12
5-4 Operation Mode .....	14
(1) Independent Operation .....	14
(2) Series Tracking Operation .....	15
(3) Parallel Tracking Operation .....	17
(4) 5V Fixed Power Supply Operation .....	19

<b>6.</b>	<b>MAINTENANCE</b>	<b>20</b>
6-1	Fuse Replacement	20
6-2	Line Voltage Conversion	20
6-3	Adjustments	20
	(1) Independent Adjustments	21
	(2) Series Tracking Adjustments	22
	(3) Parallel Tracking Adjustments	22
	(4) 5V Fixed Supply Adjustments	23
6-4	Cleaning	23

## 1. INTRODUCTION

The regulated DC power supply of C-SERIES is designed to be used in applications such as powering operational amplifier, pushpull stages, logic circuit and definition systems where plus and minus voltages are required to track with an insignificant error, and in any application where three independent power supplies housed in a single package represent an operating convenience.

The instruments consist of two identical, independently adjustable DC power supplies. A front panel switch selects one of three modes of operation: independent, series and parallel. In the independent mode, the output voltage and current of each supply are controlled separately, and each supply is isolated up to 300V from output to chassis or output to output. In the tracking mode, both outputs are automatically connected in series or parallel, and the controls of the left supply adjust the magnitudes of both the positive and negative output voltages. Because the outputs are connected in a tracking configuration, any internal disturbance in the master supply (such as drift or ripple) will cause an equal percentage change in the outputs of both the supplies.

Each power supply (except fixed 5V) is a completely transistorized, well-regulated, constant voltage/constant current supply that will furnish full rated output voltage at the maximum output current or can be continuously adjusted throughout the output range. The front panel current controls can be used to establish the output current limit (overload or short circuit) when the supply is used as a constant voltage source (independent or tracking modes) and the voltage controls can be used to establish the voltage limit (ceiling) when the supply is used as a constant current source (independent mode only). The supply will automatically cross over from constant voltage to constant current operation (current limited operation in the tracking mode) and vice versa if the output current or voltage exceeds these preset limits. Each supply has its own front panel meter that can measure output voltage or current. One power supply may be used as a master supply controlling, one slave supply furnishing various voltages or current for a system. When operated with the front panel mode switch in the tracking position, the instrument is automatically internally connected in an autotracking configuration.

For audio production line, the continuous or dynamic load is internally selectable. When the connector (J111) is connected to "ON" position suitable for audio power Amplifier application (Normal setting to "OFF" position).

## 2. SPECIFICATIONS

### 2-1 General

Main Supply (switch selectable)

Operation Environment

100V/120V/220V/240V  $\pm 10\%$  50/60Hz

Indoor use

Altitude up to 2000m

Ambient temperature 0°C to 40°C

Relative humidity 80% (maximum)

Installation Categorier II

Pollution degree 2

Storage Temperature & Humidity

-10°C to 70°C

70% (maximum)

Accessories

Test Lead (4A  $\leq$  current  $\leq$  10A) .....2

(current < 4A) .....1

Operation Manual .....1

Rating, Fuse, Watts and VA

Type	Model	Max. Rating			Replace FUSE Type		Rated Input		
		Independent	Series	Parallel	100V/120V	220V/240V	Watts	VA	
Analog	GPC-1850	0-18Vx2,	0-5Ax2	36V 5A	18V 10A	T 8A 250V	T 4A 250V	480	600
	GPC-3020	0-30Vx2,	0-2Ax2	60V 2A	30V 4A	T 5A 250V	T 2A 250V	320	400
	GPC-3030	0-30Vx2,	0-3Ax2	60V 3A	30V 6A	T6.3A 250V	T3.15A 250V	420	550
Digital	GPC-1850D	0-18Vx2,	0-5Ax2	36V 5A	18V 10A	T 8A 250V	T 4A 250V	480	600
	GPC-3020D	0-30Vx2,	0-2Ax2	60V 2A	30V 4A	T 5A 250V	T 2A 250V	320	400
	GPC-3030D	0-30Vx2,	0-3Ax2	60V 3A	30V 6A	T6.3A 250V	T3.15A 250V	420	550

Dimensions 255(W) x 145 (H) x 346 (D) m/m

Weight (Kg) 11.5

## 2-2 Operation Mode

- (1) Independent: Two independent outputs and 5V fixed output  
Output from 0 to rating volts and 0 to rating amperes.
- (2) Series: Output from 0 to  $\pm$  rating volts at rating amperes each.  
Output from 0 to double rating volts at rating amperes.
- (3) Parallel: Output from 0 to double rating amperes at rating volts.

## 2-3 Constant Voltage Operation

- (1) Output current range 0 - rating voltage continuously adjustable.
- (2) Regulation  
Line regulation  $\leq 0.01\% + 3\text{mV}$ .  
Load regulation  $\leq 0.01\% + 3\text{mV}$  (rating current  $\leq 3\text{A}$ )  
Load regulation  $\leq 0.02\% + 5\text{mV}$  (rating current  $> 3\text{A}$ )
- (3) Recovery time  $\leq 100 \mu\text{s}$  (50% load change, minimum load 0.5A)
- (4) Ripple & Noise  $\leq 1\text{mV rms}$  (5Hz-1MHz)
- (5) Temperature coefficient  $\leq 300 \text{PPM}/^\circ\text{C}$

## 2-4 Constant Current Operation

- (1) Output current range 0 - rating current continuously adjustable.
- (2) Regulation  
Line regulation  $\leq 0.2\% + 3\text{mA}$ .  
Load regulation  $\leq 0.2\% + 3\text{mA}$
- (3) Ripple current  $\leq 3\text{mA rms}$ .

## 2-5 Tracking Operation

- (1) Parallel operation  
Regulation  
Line regulation  $\leq 0.01\% + 3\text{mV}$   
Load regulation  $\leq 0.01\% + 3\text{mV}$  (rating current  $\leq 3\text{A}$ )  
 $\leq 0.02\% + 5\text{mV}$  (rating current  $> 3\text{A}$ )
- (2) Series operation  
Regulation  
Line regulation  $\leq 0.01\% + 5\text{mV}$   
Load regulation  $\leq 300\text{mV}$

### A. Positive and Negative supply (Fig 5-4)

Slave tracking error  $\leq 0.5\% + 10\text{mV}$  of the master

(No load, with load add Load regulation  $\leq 300\text{mV}$ )

### B. Single supply (Fig 5-3)



## 2-6 Meter

- (1) Digital type
  - A. Display: 3-1/2 Digits panel meter x 2 (0.5" Red LED display)
  - B. Accuracy:  $\pm (0.5\% \text{ of rdg} + 2 \text{ digits})$
  - C. Voltmeter: 19.99V of full scale (rating voltage  $\leq 18\text{V}$ ) , 199.9V of full scale (rating voltage  $\geq 20\text{V}$ )
  - D. Ammeter: 1.999A of full scale (rating current  $< 2\text{A}$ ) , 19.99A of full scale (rating current  $\geq 2\text{A}$ )
- (2) Analog type
  - A. Display: Analog Voltmeter and Ammeter each two.
  - B. Class: 2.5
  - C. Dimensions: 50x50 (m/m)

## 2-7 5V Output Specifications

- (1) Regulation                      Line regulation  $\leq 5\text{mV}$  , Load regulation  $\leq 10\text{mV}$
- (2) Ripple & Noise                 $\leq 2\text{mV rms}$ .
- (3) Voltage accuracy               $5\text{V} \pm 0.25\text{V}$
- (4) Output current                 3A

## 2-8 Insulation

- Between chassis and output terminal     $20\text{M}\Omega$  or above (DC 500V)  
Between chassis and AC cord             $30\text{M}\Omega$  or above (DC 500V)

## 3. THEORY OF OPERATION

### General

The power supply consists of an AC input circuit and transformer; a bias supply consisting of an rectifier, filter, pre-regulator and reference voltage source; a main regulator circuit consisting of the main rectifier and filter, a series regulator, a current comparator, a voltage comparator, a reference voltage amplifier and a relay control circuit.

This circuit elements including of intergrated circuit U101, U201, U202, U203, U204.

The circuit arrangement is shown in block Diagram from Fig. 1.

The circuitry is discussed with reference to the block diagram function description.

Single phase input power is applied to transformer through the input circuit.

Auxiliary rectifier D102A - D102D provides a bias voltage, filtered by capacitor C103, C104 for the preregulator. U101, Q101, Q102 that provides a regulator voltage for elements of action.

FIG. 1. BLOCK DIAGRAM

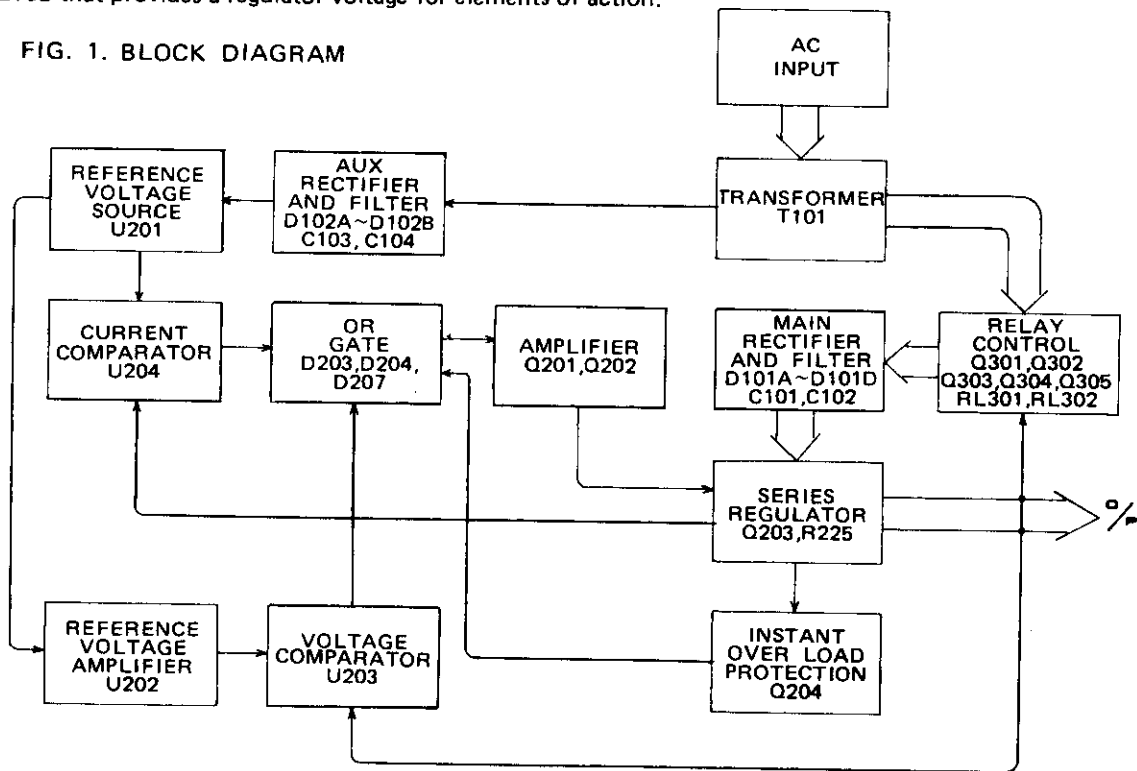

The main rectifier, a full wave bridge rectifier, provides the power which is filtered by capacitor C101, C102 and then regulated via a series regulator and delivers to the output.

U204 acted as a current limiter. When current is over predominate rating, it acted and decreased the current.

U201 provides a reference voltage for U202, U204. U202 is a inverter amplifier. U203 is a comparator amplifier which can be made comparator for reference voltage and detector feedback voltage, and then deliver to Q201, Q202, this time output voltage is calibrated.

Q205 is instant overload protection circuit. Q204 turn on when music load adds at instant. It controls Q201 current magnitude of IB makes output current limited.

The relay control circuit provides limited power dessipation in series regulator.

#### 4. PANEL CONTROLS AND INDICATORS

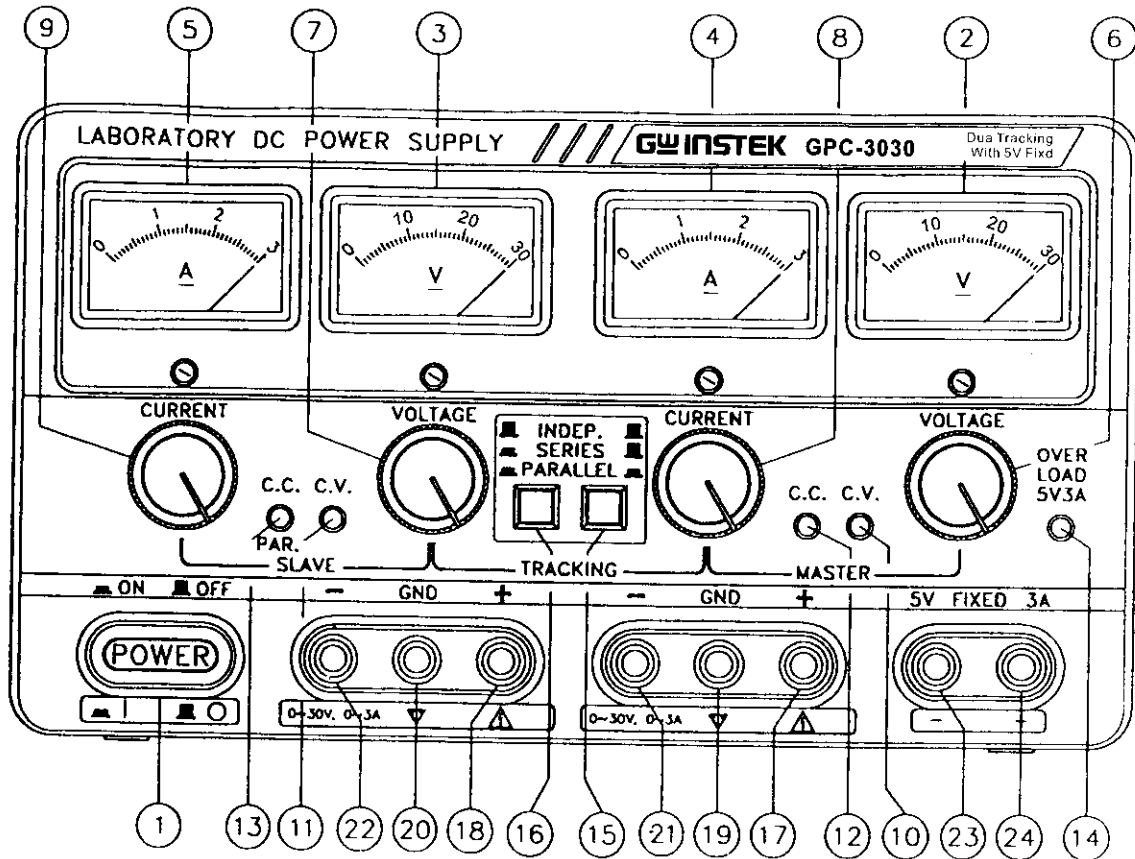

Fig. 4-1 Front Panel (Analog Type)

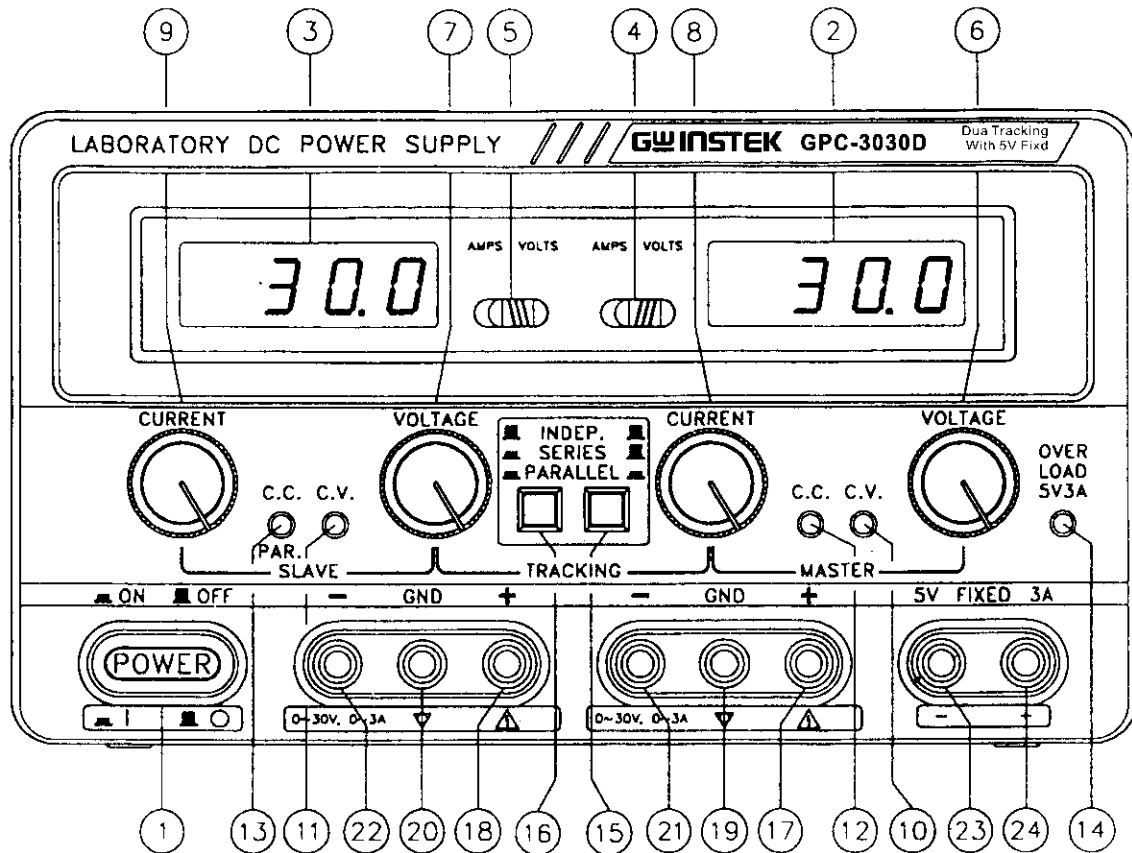

Fig. 4-2 Front Panel (Digital Type)

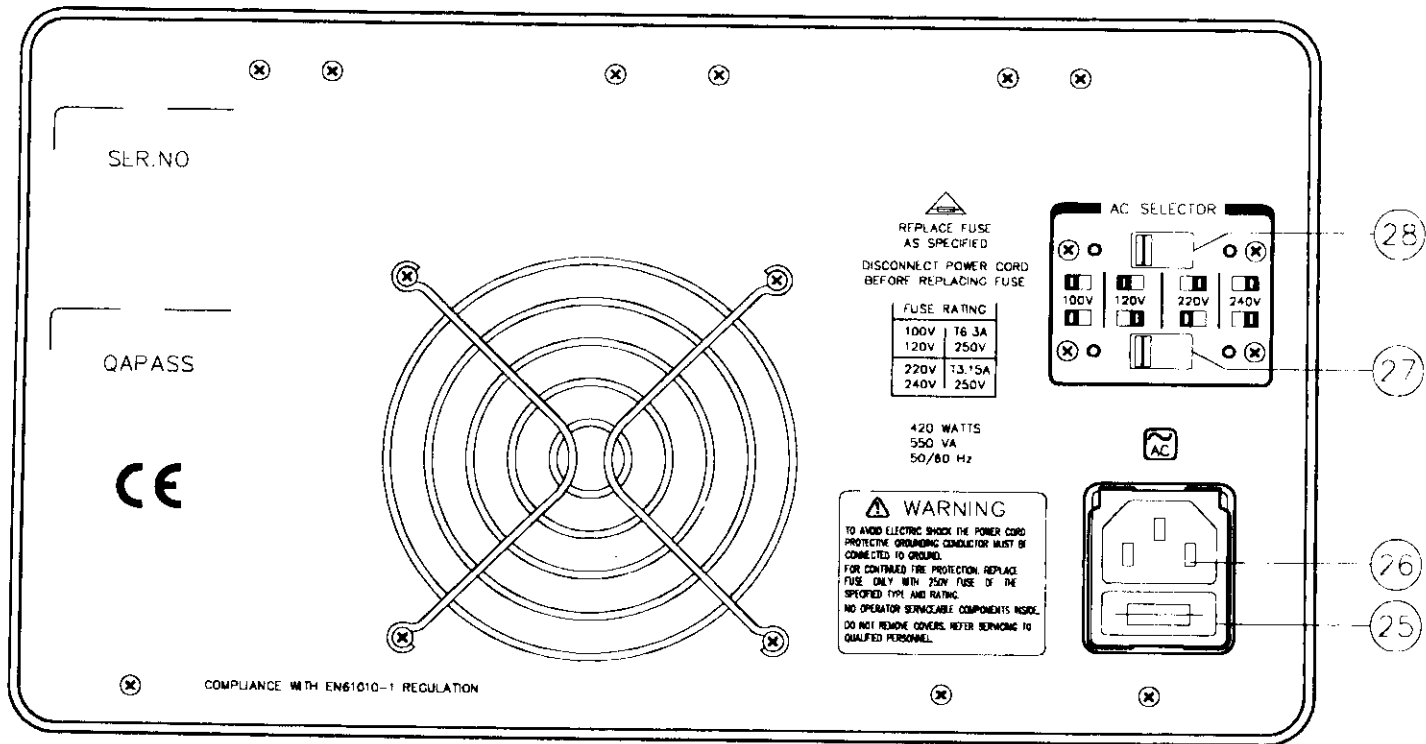

Fig. 4-3 Rear Panel

#### 4.1 Front Panel

- ① Power switch: ON/OFF the power input.
- ② Meter: Indicates the MASTER output voltage (Analog type)  
Indicates the MASTER output voltage or current (Digital type)
- ③ Meter: Indicates the SLAVE output voltage (Analog type)  
Indicates the SLAVE output voltage or current (Digital type)
- ④ Meter: Indicates the MASTER output current (Analog type)  
A/V selects switch: selects the meter indicates of the MASTER output voltage or current (Digital type)
- ⑤ Meter: Indicates the SLAVE output current (Analog type)  
A/V selects switch: selects the meter indicates of the SLAVE output voltage or current (Digital type)
- ⑥ Voltage control: for adjustment of the output voltage of the MASTER supply. Also functions as adjustment control for the maximum output voltage of the SLAVE supply when either parallel or series tracking operation.
- ⑦ Voltage control: for adjustment of the output voltage of the SLAVE supply when the independent operation.
- ⑧ Current control: for adjustment of the output current of the MASTER supply. Also functions as adjustment control for the maximum output voltage of the SLAVE supply when either parallel or series tracking operation.
- ⑨ Current control: for adjustment of the output current of the SLAVE supply.
- ⑩ C.V. indicator: lights when the MASTER supply is in the constant voltage operation, In either the Series or Parallel Tracking mode, both the MASTER AND SLAVE supplies are in the constant voltage operation.
- ⑪ C.V. indicator: lights when the SLAVE supply is in the constant voltage operation.
- ⑫ C.C. indicator: lights when the MASTER supply is in the constant current operation.
- ⑬ C.C. indicator: lights when the SLAVE supply is in the constant current operation. Also lights when the TRACKING PARALLEL mode is selected.
- ⑭ Over load indicator: lights when load on 5 volt supply becomes too large.
- ⑮ ⑯ TRACKING Mode Switches:  
Two push-button switches that select INDEPENDENT mode, series tracking mode, or parallel tracking mode as follows:

- a. When both switches are disengaged (out), the unit is in the INDEPENDENT mode and the MASTER and SLAVE power supplies are completely independent from one another.
- b. When the left switch is engaged (in) and the right switch is disengaged (out), the unit is in the TRACKING SERIES mode. In this mode, maximum voltage of both supplies is set using the MASTER VOLTAGE controls (voltage at output terminals of the SLAVE supply tracks the voltage at the output terminals of the MASTER supply). Also, in this mode of operation the positive terminal (red) of the SLAVE supply is connected to the negative terminal (black) of the MASTER supply. This allows the two supplies to be used as one 0 to double rating voltage supply.
- c. When both switches are engaged (in), the unit is in the TRACKING PARALLEL mode. In this mode the MASTER and SLAVE supplies are wired together in parallel and both the maximum current and voltage are set using the MASTER controls. The MASTER and SLAVE outputs can be used as two individual (but tracking) power supplies or just the MASTER output can be used as a 0 to rating voltage supply with a 0 to double rating current capability.

- 17 "+" output terminal: Positive polarity output terminal for the MASTER supply.
- 18 "+" output terminal: Positive polarity output terminal for the SLAVE supply.
- 19 **GND terminal: Earth and chassis ground.**
- 20 **"GND terminal: Earth and chassis ground.**
- 21 "-" output terminal: Negative polarity output terminal for the MASTER supply.
- 22 "-" output terminal: Negative polarity output terminal for the SLAVE supply.
- 23 "-" output terminal: Negative polarity output terminal for 5V supply.
- 24 "+" output terminal: Positive polarity output terminal for 5V supply.

#### 4-2 Rear Panel

- 25 Fuse holder
- 26 Power socket
- 27 AC selects switch With 28 HI-LO switch selects to permit operation from 100, 120, 220 or 240VAC, 50/60HZ line voltage.
- 28 HI-LO switch HI position selects high voltage range (120, 240V AC inputs), LO position selects low voltage range (100V, 220V AC inputs).
- 29 Cooling fan Ventilates the hot air out, to prevent output stage from thermo shock, and also improves the temperature coefficient.



## 5. OPERATION INSTRUCTIONS

### 5-1 Precaution

- (1) AC input  
AC input should be within the range of line voltage  $\pm 10\%$  50/60Hz



**WARNING.** To avoid electrical shock, the power cord protective grounding conductor must be connected to ground.

- (2) Installation

Avoid using the supply in a place where ambient temperature exceeds 40°C. The heat sink located at the rear of the supply must have sufficient air space for radiation.



**CAUTION.** To avoid damaging the power supply, don't use it in a place where ambient temperature exceeds 40°C.

- (3) Output voltage overshoot

Maybe voltage between output terminals exceeds the present value when the power is turned on or off.

### 5-2 Setting Current Limit

- (1) Determine the maximum safe current for the device to be powered.
- (2) Temporarily short the (+) and (-) terminals of the power supply together with a test lead.
- (3) Rotate the VOLTAGE control away from zero sufficiently for the CC indicator to light.
- (4) Set the meter selection switch to the A position to select the current metering mode (Digital type only).
- (5) Adjust the CURRENT control for the desired current limit. Read the current value on the Ammeter.
- (6) The current limit (overload protection) has now been preset. Do not change the CURRENT control setting after this step.
- (7) Remove the short between the (+) and (-) terminals and hook up for constant voltage operation.

### 5-3 Constant Voltage/Constant Current Characteristics

The working characteristic of these series Power Supplies is called a constant voltage/constant current automatic crossover type. This permits continuous transition from constant current to constant voltage modes in response to the load change. The intersection of constant voltage and constant current modes is called the crossover point. Fig. 5-1 shows the relationship between this crossover point and the load.

For example, if the load is such that the power supply is operating in the constant voltage mode, a regulated output voltage is provided. The output voltage remains constant as the load increases, up until the point where the present current

limit is reached. At that point, the output current becomes constant and the output voltage drops in proportion to further increases in load. The point is indicated by the front panel LED indicators. The crossover point is reached when the CV indicator goes off and the CC indicator comes on.

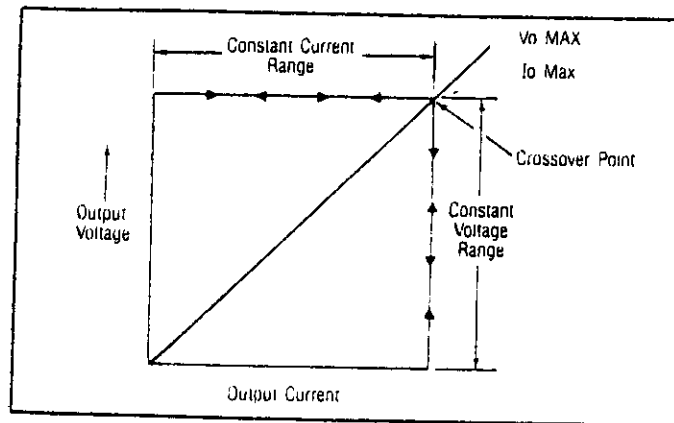

Fig. 5-1 Constant Voltage/Constant Current Characteristic.

Similarly, crossover from the constant current to the constant voltage mode automatically occurs from a decrease in load. A good example of this would be seen when charging a 12-volt battery. Initially, the open circuit voltage of the power supply may be preset for 13.8 volts. A low battery will place a heavy load on the supply and it will operate in the constant current mode, which may be adjusted for a 1 amp charging rate. As the battery becomes charged, and its voltage approaches 13.8 volts, its load decreases to the point where it no longer demands the full 1 amp charging rate. This is the crossover point where the power supply goes into the constant voltage mode.

## 5-4 Operation Mode

### (1) Independent Operation

The "MASTER" and "SLAVE" supplies each provide a 0 to rating volts output at up to rating amps. This procedure covers the use of the MASTER and SLAVE supplies only when they are used independently from one another. When used in the INDEPENDent operating mode, the operating controls of the two power supplies are completely independent and either supply can be used individually or both can be used simultaneously.

- A. Disengage both TRACKING mode switches (both switches out) so that the power supply is in the INDEPENDent operating mode.
- B. Adjust "Voltage" control and "Current" control to the desired output voltage and current.
- C. Turn off the power supply and the equipment to be powered during hook-up.
- D. Connect the positive polarity of the device being powered to the red (+) terminal of the power supply.
- E. Connect the negative polarity of the device being powered to the black (-) terminal of the power supply.
- F. Fig. 5-2 illustrates the connection procedure.

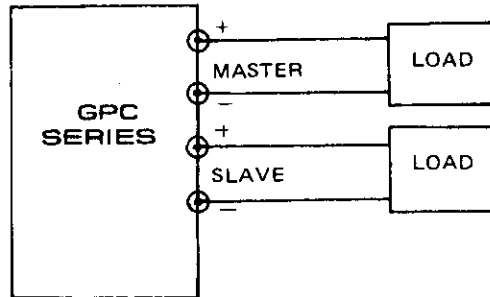

Fig. 5-2 Independent Operation

## (2) Series Tracking Operation

When the series tracking mode of operation is selected, the positive (red) terminal of the SLAVE supply output is internally connected to the negative (black) terminal of the MASTER supply.

In the series tracking mode, the maximum output voltage of both the MASTER and SLAVE supplies can be simultaneously varied with one control. The maximum SLAVE supply voltage is automatically set to the same as the MASTER supply by using the MASTER VOLTAGE controls.

- A. Set the power supplies to the TRACKING SERIES mode by engaging the left TRACKING switch and release the right TRACKING switch.
- B. Set the MASTER A/V switch to the V (voltage metering) position, and the SLAVE A/V switch to the A (current metering) position (Digital type only).



**WARNING.** Voltage more than 60V DC are a lethal shock hazard to the user. Be careful when connecting power supplies in series to achieve voltages higher than 60V DC total or 60V DC between any connection and earth ground.

### NOTE:

Simultaneous metering of both current and voltage can be obtained in this mode of operation by setting one of the displays for current metering and one for voltage metering. In this case, the output voltage (across the two supplies) is actually double the displayed value. For example, if the MASTER display is set for voltage metering and the SLAVE display for current metering, the output voltage across the MASTER positive (red) terminal and the SLAVE negative (black) terminal would be double the reading on the MASTER LED Display (since both supplies are putting out the same voltage). The actual output current would be the value read from the SLAVE LED Display (since the two supplies are wired in series, current flowing through each supply must be equal).

- C. Set the SLAVE CURRENT control to the fully clockwise position. The maximum current is set using the MASTER CURRENT control. Follow the instructions for "Setting Current Limit" (INDEPENDENT USE OF "MASTER" OR "SLAVE" SUPPLY section of this manual, using the MASTER CURRENT control).

**NOTE:**

Because the supplies are being used in series, either CURRENT control can be used to set maximum current. If desired, the MASTER CURRENT control can be rotated fully clockwise and the SLAVE CURRENT control can be used to adjust the maximum current value. Because current through the two supplies must be equal when they are being used in series, the lowest CURRENT control setting will set the maximum output current.

- D. Adjust the output voltage to the desired level using the MASTER VOLTAGE controls..
- E. Turn off the power supply and the equipment to be powered during hook-up.
- F. If "single supply" operation is desired, this allows the power supply to be used as twice the voltage and rating current simply by using the negative (black) terminal of the SLAVE supply and the positive (red) terminal of the MASTER supply, the configuration as shown in Fig. 5-3.

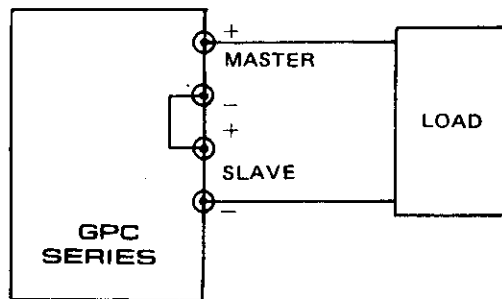

Fig. 5-3 Single Supply

G. If the chassis or common of the equipment being powered is separate from both the positive and negative polarity power inputs. The output of the SLAVE (negative) supply tracking the output of the MASTER (positive) supply, the configuration as shown in Fig. 5-4.

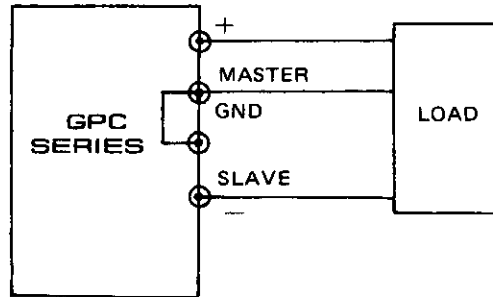

Fig. 5-4 Positive and Negative Supply

### (3) Parallel Tracking Operation

In the parallel tracking mode of operation, both supplies are strapped together (in parallel). This allows for a rating voltage supply with a double rating current capability. Only the MASTER output terminals are used for parallel tracking operation. In the parallel tracking mode, the SLAVE supply output voltage and current track the MASTER supply output voltage and current.

A. Set the power supplies to the TRACKING PARALLEL mode by engaging both TRACKING switches.

- B. Set the MASTER A/V switch to the V (voltage metering) position, and the SLAVE A/V switch to the A (current metering) position. Output voltage will now be read from the MASTER LED Display. Output current is exactly double the value read from the SLAVE LED Display (because each supply is providing the same amount of current). (Digital type only).
  - C. Because both voltage and current of the SLAVE supply track the MASTER supply, the maximum current and voltage are set using the MASTER controls. Using the MASTER supply output jacks, follow the instructions for "Setting Current Limit" (5-2 Section). Remember that the actual current output at the MASTER supply output jacks is double the reading on the SLAVE indicator meter.
  - D. Adjust the output voltage to the desired level using the MASTER VOLTAGE controls.
  - E. Turn off the power supply and the equipment to be powered during hook-up.
  - F. Connect the positive polarity of the device being powered to the red (+) terminal of the MASTER power supply.
  - G. Connect the negative polarity of the device being powered to the black (-) terminal of the MASTER power supply.
- The configuration as shown in Fig. 5-5.

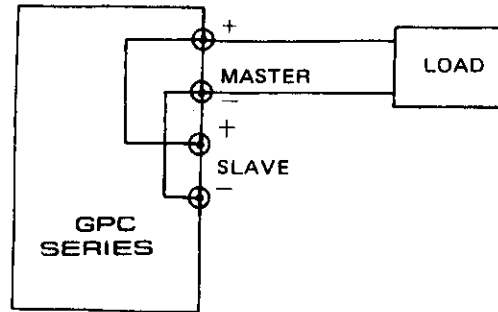

Fig. 5-5. Parallel Tracking Operation

(4) 5V Fixed Power Supply Operation

The fixed 5V supply provides a 5V DC output with a 3 amp current capacity. The supply is ideal for use with TTL circuits.

- A. Turn off the power supply and the equipment to be powered during hook-up.
- B. Connect the positive polarity of the device being powered to the red (+) terminal of the 5V supply.
- C. Connect the negative polarity of the device being powered to the black (-) terminal of the 5V supply.
- D. If the red OVERLOAD indicator lights, too much load has been placed on the supply. This will cause voltage and current to drop and prevent proper operation of the 5V supply. To correct this situation, the load on the supply must be decreased so that no more than 3 amps of current are required.

(5) Dynamic Load Operation & Application

- A. When select to dynamic load position, the max peak current is 1.7 times rating current. The features are only applied for audio circuit of amplifier and audio production lines.  
Change jump wire (DL1 master, DL2 slave) to J109 master, J309 slave at "ON" position. Ref. to Fig. 6-1. Adjustment Location.
- B. For other application and testing (Safety or CE ..etc.), must set the jump wire at "OFF" position.



## 6. MAINTENANCE

### WARNING

The following instructions are for use by qualified personnel only. To avoid electrical shock, do not perform any servicing other than contained in the operating instructions unless you are qualified to do so.

#### 6-1 Fuse Replacement

If the fuse blows, the CV or CC indicators will not light and the power supply will not operate. The fuse should not normally open unless a problem has developed in the unit. Try to determine and correct the cause of the blown fuse, then replace only with a fuse of the correct rating and type (see Page 2).

The fuse is located on the rear panel (see Fig. 4-3).



**WARNING.** For continued fire protection. Replace fuse only with 250V fuse of the specified type and rating, and disconnect power cord before replacing fuse.

#### 6-2 Line Voltage Conversion

The primary winding of the power transformer is tapped to permit operation from 100, 120, 220, or 240 VAC, 50/60 Hz line voltage. Conversion from one line voltage to another is done by change AC selects switch as shown in Fig. 4-3.

The rear panel identifies the line voltage to which the unit was factory setted. To convert to a different line voltage, perform the following procedure:

- (1) Make sure the power cord is unplugged.
- (2) Change the AC selects switch to the desired line voltage position.
- (3) A change in line voltage may also require a corresponding change of fuse value. Install the correct fuse value as listed on rear panel.

#### 6-3 Adjustments

This unit was accurately adjusted at the factory before shipment. Readjustment is recommended only if repairs have been made in a circuit affecting adjustment accuracy or if you have a reason to believe the unit is out of adjustment. However, adjustments should be attempted only if a multimeter with an accuracy of  $\pm 0.1\%$  dcv or better is available (GOOD WILL Model GDM-8045G or equivalent).

If readjustment is required, use the following procedure. Locations of the adjustments are shown in Fig. 6-1 to Fig. 6-3.

**(1) Independent Adjustment**

- A. Disengage both TRACKING mode switches (both switches out) so that the power supply is in the INDEPENDent operating mode.
- B. Connect an accurate ( $\pm 0.1\%$ ) external 4-1/2 digit multimeter to measure the dc voltage at the output terminals of the MASTER (SLAVE) supply.
- C. Set the MASTER (SLAVE) VOLTAGE controls to minimum (fully counterclockwise).
- D. Adjust trimmer potentiometer (VR102 master, VR302 slave) on the circuit board (located on the right side of the supply) for a reading of  $-15 \text{ mV} \pm 15 \text{ mV}$  on the multimeter.
- E. Set the MASTER (SLAVE) VOLTAGE controls to maximum (fully clockwise).
- F. Adjust trimmer potentiometer (VR101 master, VR301 slave) on the circuit board (located on the right side of the supply) for a reading as close to rating voltage  $\times 1.05$  (on the multimeter) as possible.

**NOTE:**

Set the MASTER (slave) A/V switch to the V position (Digital type only)

- G. Adjust trimmer potentiometer VR207 (VR201 master, VR601 slave Digital type) on the master (slave) voltage indicator circuit board (located on the meter or A/D converter board) for a reading of rate voltage  $\times 1.05$  on the MASTER (SLAVE) meter (LED display, digital type only).
- H. Connect the external multimeter across the MASTER (SLAVE) SUPPLY output terminals to read the output current (so that the meter causes a short circuit across the terminals) and adjust the MASTER (SLAVE) CURRENT control so that rating amps is read on the multimeter.

**NOTE:**

Set the MASTER (SLAVE) A/V switch to the A position (Digital type only).

- I. Adjust VR208 (VR202 master, VR602 slave, Digital type only) so that the MASTER (SLAVE) meter (LED display; digital type only) also reads rating amps
- J. Rotate the MASTER (SLAVE) current control fully clockwise (maximum).
- K. Adjust VR103 on the master (VR303 slave) supply circuit board (located on the right side of the supply) to obtain an output current of rating amps  $\times 1.05$  (read on the meter or LED display)

## **(2) Series Tracking Adjustment**

- A. Set the supply to the TRACKING SERIES mode by engaging the left TRACKING switch and releasing the right TRACKING switch.
- B. Set the SLAVE CURRENT control to midrange and set the MASTER SUPPLY VOLTAGE controls to minimum (fully counterclockwise).
- C. Connect the multimeter to the MASTER SUPPLY outputs and measure the voltage.
- D. Disconnect the multimeter from the MASTER SUPPLY outputs and connect it across the SLAVE SUPPLY outputs.
- E. Adjust trimmer potentiometer VR306 on the circuit board (located on the right side of the supply) to obtain the exact same reading for the SLAVE SUPPLY output as was present at the MASTER SUPPLY output (e.g., if the minimum MASTER SUPPLY output voltage is -10.00 mV adjust VR306 to obtain an output voltage as close to -10.00 mV at the SLAVE SUPPLY as possible).
- F. Set the SLAVE CURRENT control to midrange and set the MASTER SUPPLY VOLTAGE controls to maximum (fully clockwise).
- G. Connect the multimeter to the MASTER SUPPLY outputs and measure the voltage.
- H. Disconnect the multimeter from the MASTER SUPPLY outputs and connect it across the SLAVE SUPPLY outputs.
- I. Adjust VR501 (located at the left of the lower front panel circuit board, VOLTAGE/CURRENT CONTROL potentiometer board) until the voltage read from the multimeter is the same as it was across the MASTER output terminals. Return the multimeter to the MASTER output terminals and verify that the output voltage is identical. If not, repeat this step.

## **(3) Parallel Tracking Adjustment**

- A. Disengage both TRACKING mode switches (both switches out) so that the power supply is in the INDEPENDENT operating mode.
- B. Set the MASTER SUPPLY VOLTAGE and CURRENT controls to minimum (fully counterclockwise).
- C. Connect the multimeter across the MASTER SUPPLY output terminals and measure the output current.

- D. Set the MASTER SUPPLY VOLTAGE control to midrange and Adjust the CURRENT control to obtain an output current of rating amps (read on the multimeter). Do not change the CURRENT control setting after this step.
- E. Engaged both TRACKING mode switches (both switches in) so that the power supply is in the PARALLEL operating mode.
- F. Set the SLAVE SUPPLY CURRENT control to maximum (fully clockwise) and set the VOLTAGE control to mid-range.
- G. Adjust trimmer potentiometer VR502 on the circuit board (located on the right side of the supply) to obtain an output current of double rating amps on the multimeter.

#### (4) Fixed 5V Supply Adjustment

- A. Connect the multimeter across the output terminals of the 5V SUPPLY to read output voltage and adjust the VR401 to obtain a reading of 5.00 volts on the multimeter.
- B. Turn VR403 on the main master circuit board (located on the right side of the supply) fully counterclockwise.
- C. Connect a variable load (load must be rated to handle a power of at least 30 W) across the output terminals and connect the multimeter to read the output current, then adjust the load to multimeter shows an output current is 3.25A.
- D. Slowly adjust VR403 clockwise until the output voltage (read from the multimeter) drops by 5 to 6 mV (start current limit point).
- E. Connect a variable load across the output terminals and connect the multimeter to read the output current, then adjust the load to multimeter shows an output current is 3.10A.
- F. *Adjust VR402 until the 3A OVERLOAD indicator first lights.*

#### 6-4 Cleaning

To clean the power supply, use a soft cloth dampened in a solution of mild detergent and water. Do not spray cleaner directly onto the instrument, since it may leak into the cabinet and cause damage.

Do not use chemicals containing benzene, benzene, toluene, xylene, acetone, or similar solvents.

Do not use abrasive cleaners on any portion of the instrument.

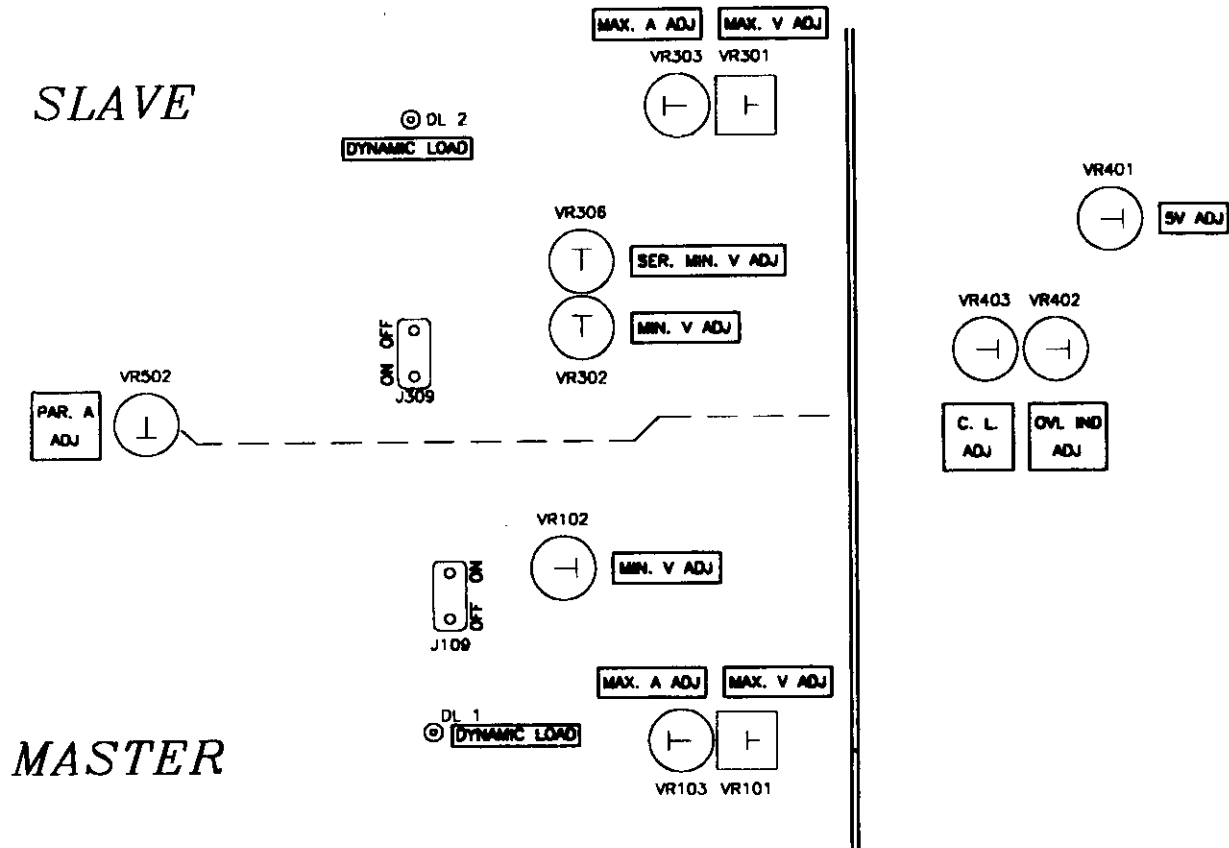

FIG. 6-1. Adjustment Location



U601

*SLAVE*



VR601  
V. ADJ



VR602  
A. ADJ



VR202  
A. ADJ

A. ADJ A. ADJ



U201

*MASTER*

V. ADJ



VR201

FIG. 6-2. Adjustment Location

V TRACKING BAL. VR501

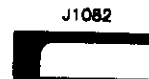
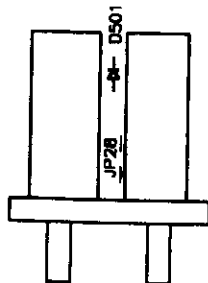

FIG. 6-3. Adjustment Location