



**Micro drone build and
set-up instructions**



Contents

Building the drone	3
Binding the drone to the transmitter	6
Setting up fail safe	8
Setting up the auxiliary switches on the transmitter	9
Betaflight settings	12
VTX frequency table	14
Drone factory settings	16

What is in the kit

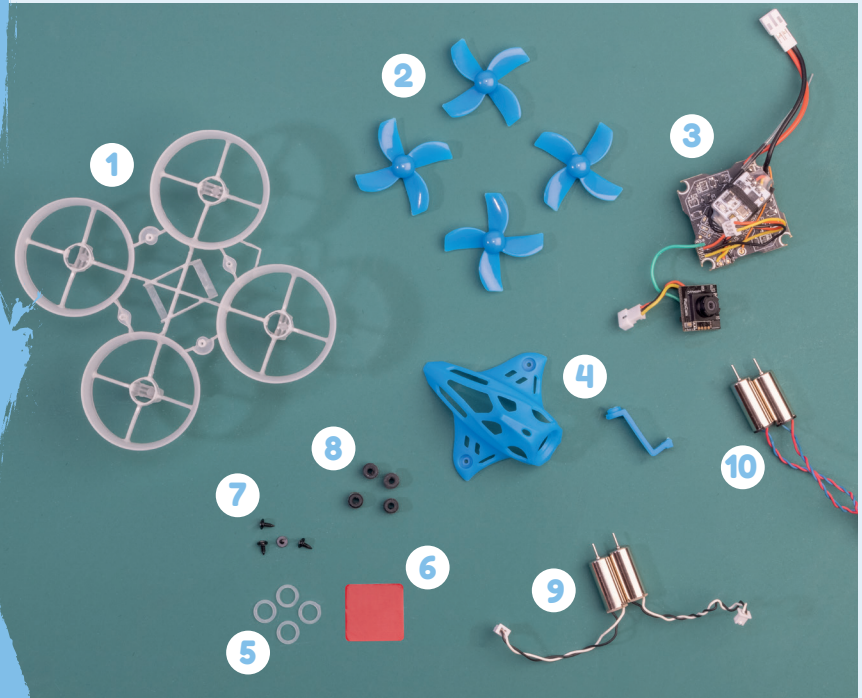

SPARE STICKY PAD

A spare sticky pad has been provided that can be cut to size for mounting the receiver

1. Frame
2. 4x Propellers
3. Flight controller with nano camera and receiver
4. Canopy with camera clip
5. Elastic bands
6. Spare sticky pad for the receiver
7. 4x Screws
8. 4x Rubber frame mounts
9. Counter-Clockwise CCW motors
10. Clockwise CW motors

Tools required: Small tip crosshead screwdriver.

Building the drone

1 Connecting the camera to the canopy

STEP 1

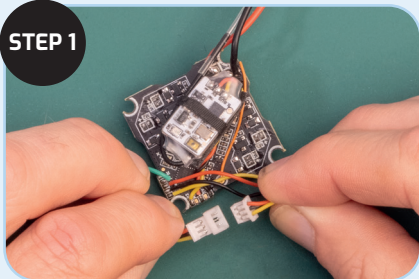

If not already done, connect the camera and the board connectors together.

Insert the camera into the hole provided in the canopy. The camera is secured in position by fitting the camera clip.

STEP 2

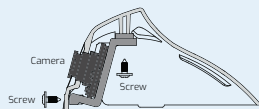
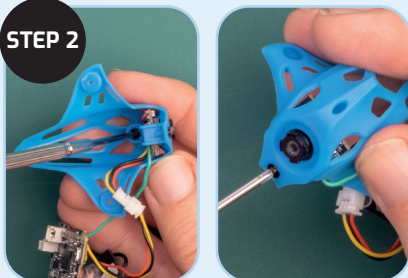

Insert the two screws to hold camera in place with the camera clip. Secure the clip to the inside top of the canopy using one of the screws, then secure the clip to the rear of the canopy below the camera using the other screw.

Make sure the camera is the correct way round - Wires pointing down

2 Connecting the Board to the frame

STEP 1

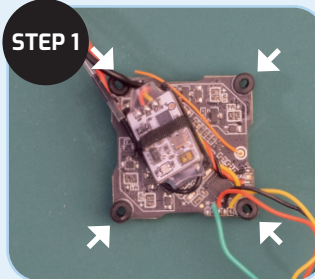

Push fit the rubber frame mounts onto the four corners of the flight controller.

STEP 2

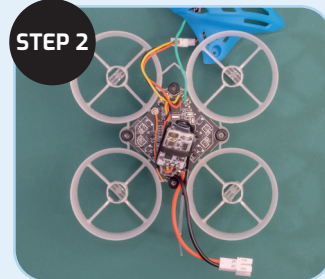

Gently push the board onto the frame aligning the pegs on the frame with the rubber frame mounts. Make sure the frame and the board are facing the right direction (see below).

STEP 3

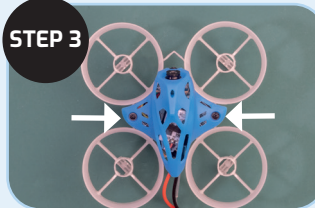

Insert the two screws through the canopy into the frame, to secure the canopy in position.

Notch in frame indicates front

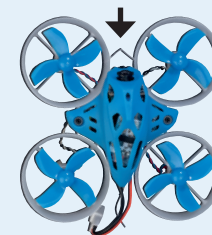

Battery cable and ariel indicates the back of the board

You might want to leave fitting of the canopy, until Binding the Drone to the Transmitter has been done (see page 6).

Building the drone

3 Attaching the motors

STEP 1

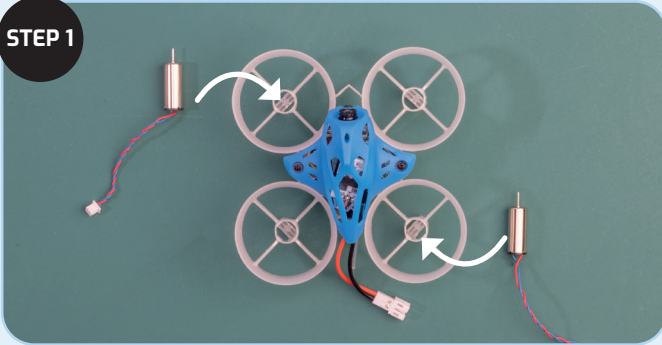

Select the two Clockwise CW motors (Red and Blue wires). Place a motor on top left and bottom right of the frame (as shown). Feed the motor cable through the hole and out of this side, then slowly push the motor through the hole as far as it will go. Repeat for the second motor.

STEP 2

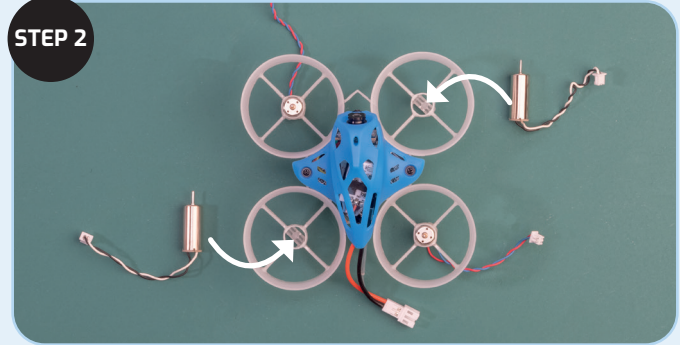

Select the other two Counter-Clockwise CCW motors (Black and White wires) and fit the motors in the two spare slots, as described in Step 1.

STEP 3

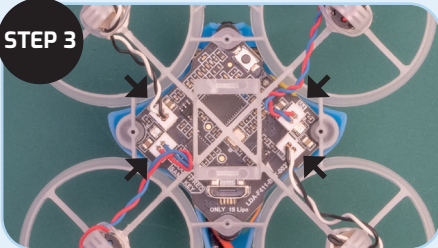

Turn the drone upside down and plug the motors into the board. Take care to connect each motor to the connector closest to that motor (as shown).

STEP 4

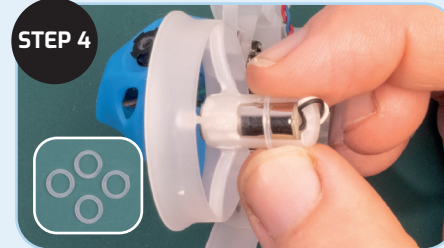

Place an elastic band around each of the frame motor holders and the cable to keep the cable held tight to the frame.

Building the drone

4 Attaching the propellers

STEP 1

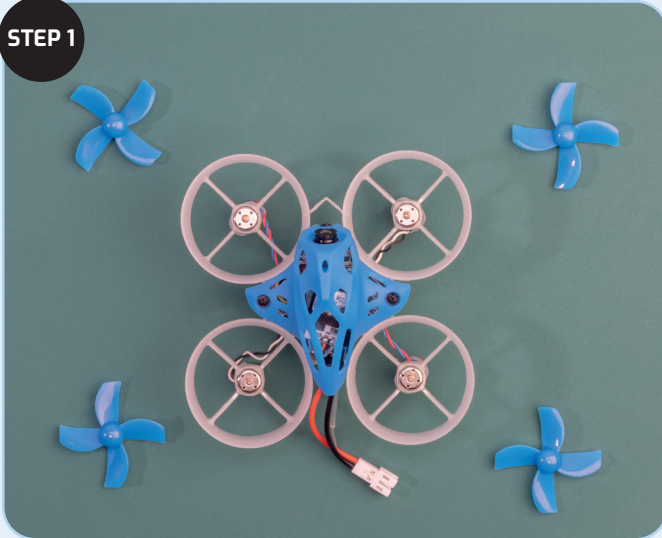

Add the propellers by gently pushing them down onto the motor spindles.

IMPORTANT: Make sure that orientation of the propellers on the motors is correct as shown in the image above. When fitted, the curved part of the blade faces in the direction of rotation for each motor, as shown in the image on the right.

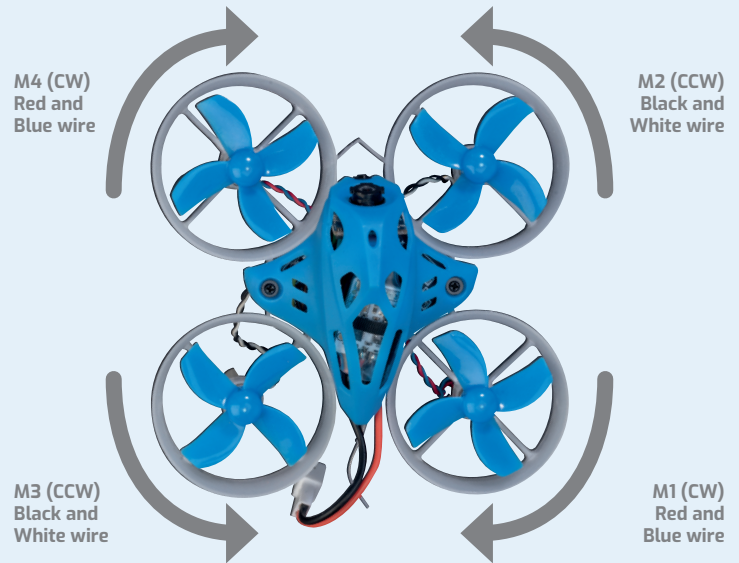

Double check that the propeller blades are correctly attached. The curved part of the blades should be facing the direction of rotation (as shown above).

Binding the drone to the transmitter

STEP 1

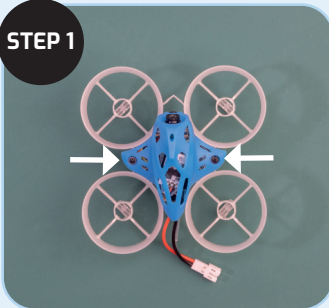

Remove the canopy from the frame by unscrewing the two screws

STEP 2

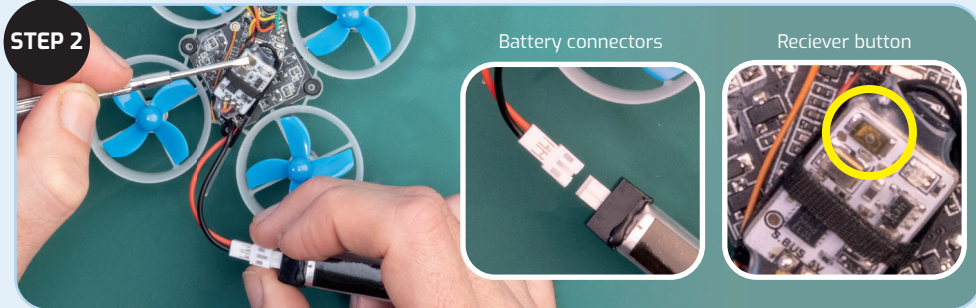

TIP: Get someone to help you with this step. The battery needs to be connected at the same time as pressing the button on the receiver board to bind correctly. While pressing down on the button on the receiver connect the battery, as shown. Hold down the button on the receiver until the green LED (fast blink) comes ON (see Step3).

STEP 3

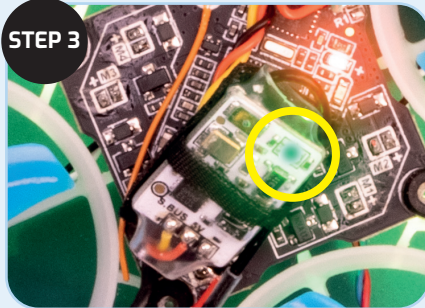

A green LED (fast blink) means the receiver is in the bind mode, you can now release the button.

STEP 4



Turn on the transmitter by pressing the two ON/OFF buttons located either side of the screen. Make sure that all switches are in the up position and the left-hand control stick is down.

Binding the drone to the transmitter

STEP 5

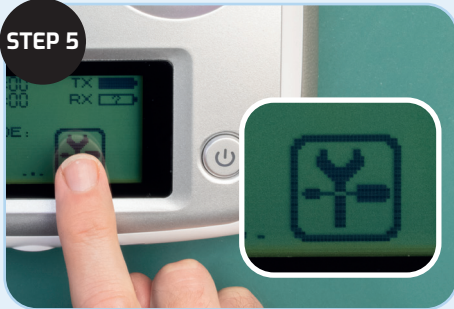

On the Transmitter touch screen, Press the spanner/screwdriver icon and select **SYSTEM**.

STEP 6



Select **MODEL** (if this is the only model you are using on this transmitter select **MODEL 1**). Then press the back arrow (top left of screen).

STEP 7

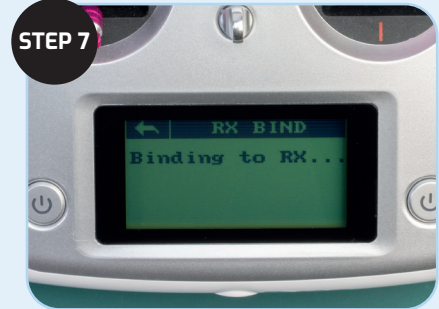

Select model **RX BIND**, this puts the transmitter into bind mode.

STEP 8

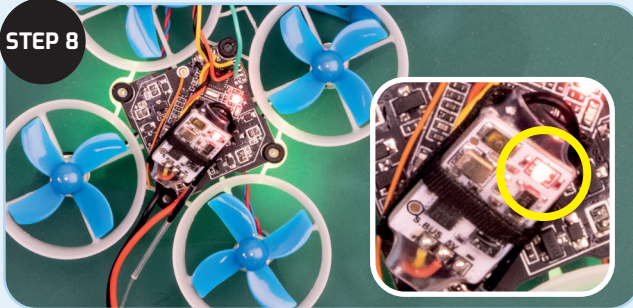

The green LED on the receiver will turn off and the red LED will illuminate to indicate that binding is complete.

STEP 9

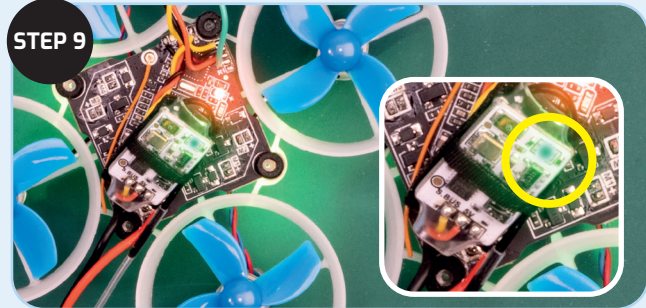

Exit the transmitter from bind mode, by pressing the back arrow (top left of screen). The green LED on the receiver will be now illuminate to indicate that it is working normally. Refit the canopy (see page 3, Step3).

Setting up the failsafe

STEP 1

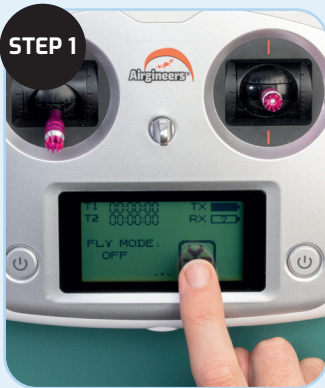

Turn on the transmitter, by pressing the two ON/OFF buttons located either side of the screen. Press the spanner/screwdriver icon on the screen, then select **FUNCTION**. Scroll down to the bottom and select **Failsafe**.

STEP 3



Select **FAILSAFE** for **Ch3**, select **ON**.

NOTE: Ch3 controls the up/down (throttle) movement of the left-hand control stick.

Make sure the left-hand control stick is all the way down. Press **SETUP** (-100% shows on screen).

STEP 2



Select **FAILSAFE** for **Ch1**, by pressing **OFF**.

On the next screen select **ON**.

NOTE: Ch1 controls the left/right movement of the right-hand control stick. You can test this by moving the control stick left and right, the movement should be indicated in the bar across the bottom of the screen as the stick moves.



Make sure that the stick is in the neutral (centre) position and press **SETUP**. Then use the back arrow to go back to the Failsafe -channel select menu. You should now see that **Ch1** is set to 0%.



Repeat the setup procedure for **Ch2** and **Ch4**.

NOTE: Ch2 controls the forward/backward movement on the right-hand control stick. Ch4 controls the left/right movement of the left-hand control stick.

STEP 4

Use the back arrow to go back to the Failsafe channel select menu. You should now see that Ch3 is set to -100% and Ch1, 2 and 4 are set to 0%. Failsafe is now set up. Use the back arrow to return to the main menu.



IMPORTANT: Setting the Failsafe mode allows the drone to stop flying and drop to the ground in the event of loss of transmission.

Setting up the auxiliary switches on the transmitter



Setting up the auxiliary switches on the transmitter

IMPORTANT: The Auxiliary (Aux) Switches need to be Set-up, so that drone will fly correctly using the channels set on the transmitter.

STEP 1



Turn on the transmitter and press the spanner/screwdriver icon, then select **SYSTEM**.

STEP 2



Select **MODEL**, and select the Model number that the drone has been binded to. Then return to the **SYSTEM** menu, using the back arrow at top left of the screen.

STEP 3



Select the **FUNCTION** menu. Scroll down the menu to select **Aux. channels**.

NOTE: You need to set up two Switches, one for Channel 5 and one for Channel 6. This is done in the following Steps.

STEP 4



Select **CHANNEL 5** and press the no entry icon to access the Settings.

Setting up the auxiliary switches on the transmitter

STEP 5

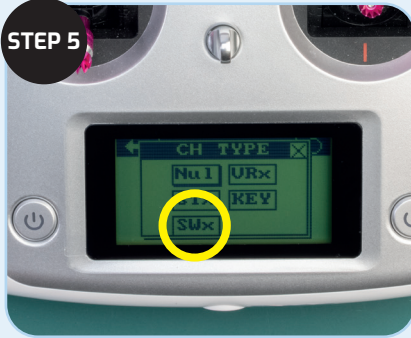

Select **SWx**.

STEP 6



Press **SwA** and change **SwA** to **SwD**. **Channel 5** is now set-up on **SwD**.

STEP 7



Now select **CHANNEL 6**, then press the no entry symbol and select **SWx**.

STEP 8



Press **SwA** and change **SwA** to **SwC**. **Channel 6** is now set-up on **SwC**.

Return to the main menu using the back arrow at top left of the screen.

Betaflight settings

1 MODE settings

Betaflight Configurator
Configurator: 10.8.0 (Sec9465)
Firmware: 4.2.0 (BTFL)
Target: LDAR/LDARCF41 (ISTM32F411)

2022-11-22 @12:30:30 - Arming Disabled

Setup Ports Configuration Power & Battery Presets PID Tuning Receiver Modes Motors OSD Video Transmitter LED Strip Blackbox CLI

Modes

Configure modes here using a combination of ranges and/or links to other modes (links supported on BF 4.0 and later). Use ranges to define the switches on your transmitter and corresponding mode assignments. A receiver channel that gives a reading between a range min/max will activate the mode. Use a link to activate a mode when another mode is activated. **Exceptions:** ARM cannot be linked to or from another mode, modes cannot be linked to other modes that are configured with a link (chained links). Multiple ranges/links can be used to activate any mode. If there is more than one range/link defined for a mode, each of them can be set to **AND** or **OR**. A mode will be activated when:

- ALL **AND** ranges/links are active; OR
- at least one **OR** range/link is active.

Remember to save your settings using the Save button.

Hide unused modes

Mode	AUX	Min	Max	Link
ARM	AUX 1	1700	2100	
ANGLE	AUX 2	900	1200	
HORIZON				
HEADFREE				
FAILSAFE				
HEADADJ				

Port utilization: D: 31 % U: 2 % Packet error: 0 I2C error: 0 Cycle Time: 250 CPU Load: 6 %

Configurator: 10.8.0 (Sec9465), Firmware: 4.2.0 (BTFL), Target: LDAR/LDARCF41 (ISTM32F411)

Above are the basic MODE settings for your drone.

Betaflight settings

2 Turn OFF AIRMODE

The screenshot shows the Betaflight Configurator interface. The 'Other Features' section is expanded, and the 'AIRMODE' setting is highlighted with a red box. The 'AIRMODE' toggle is currently turned ON. A red arrow points to the 'AIRMODE' toggle switch. The interface also shows other settings like 'INFLIGHT_ACC_CAL', 'SERVO_TILT', 'SOFTSERIAL', 'SONAR', 'LED_STRIP', 'DISPLAY', 'CHANNEL_FORWARDING', 'TRANSPONDER', 'OSD', and 'DYNAMIC_FILTER'. The 'Save and Reboot' button is visible at the bottom right of the settings panel.

IMPORTANT: Make sure that AIRMODE is turned OFF before attempting to fly the drone.

Betaflight settings

3 Turn ON MOTOR_STOP

The screenshot shows the Betaflight Configurator interface. The 'Motors' tab is selected, and the 'MOTOR_STOP' option is highlighted with a red box. The option is currently turned on, indicated by a yellow toggle switch. The interface also shows a diagram of a quadcopter with motor directions, a graph of motor speed over time, and various motor parameters like voltage, amperage, and RPM.

Make sure you have MOTOR_STOP turned on, as this will stop the motors spinning when armed.

NOTE: The advantage of having this turned off is that you know the drone is armed. The disadvantage is that if you flip the drone in a crash the motors will keep spinning until you disarm the drone. This feature is important to have switched off for larger drones but is not necessary on these micro-drones.

VTX frequencies

Single click on the FC board button to change the VTX channel when powered on to the frequency you require.

	CH1	CH2	CH3	CH4	CH5	CH6	CH7	CH8
BAND 1								
BAND 2				5790MHz				
BAND 3								
BAND 4	5740MHz	5760MHz	5780MHz		5820MHz		5860MHz	
BAND 5			5732MHz	5769MHz	5806MHz	5843MHz		

VTX frequencies

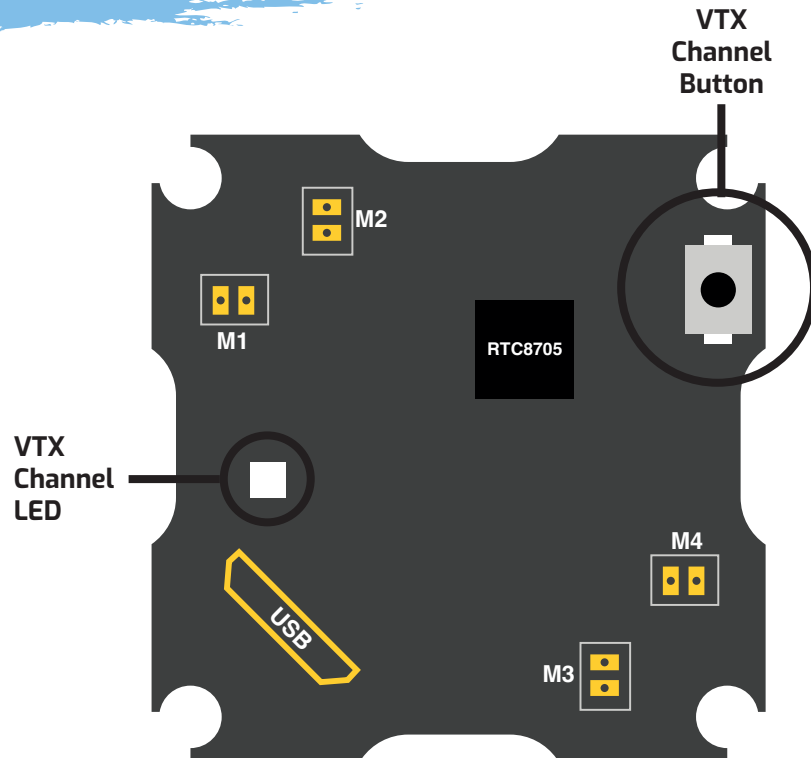

Bottom of flight controller board

VTX channel button

Click this button to change between the VTX channels.

NOTE: Press and hold button and power on to put the board into direct firmware update (DFU) mode(STM32 boot mode) if you need to update the board software.

VTX channel LED

This LED indicates the VTX frequency you have selected, see chart below.

Channel	5806MHZ	5780MHZ	5790MHZ
5769MHZ	5843MHZ	5740MHZ	5820MHZ
5732MHZ	5760MHZ	5860MHZ	