

**SPECIFICATION:**

Operating Voltage (Max.): 60 Vdc  
 Operating Current (Nom.): 10 A  
 Operating Temperature: -20°C to 90°C  
 Insulation Resistance (Min.): 500 MΩ  
 Contact Resistance (Max.): 5 mΩ

**MATERIAL:**

Material (Terminal): brass, nickel plated  
 Material (Housing): ABS  
 Material (Contact Area): brass, nickel plated

**HANDLING:**

Terminal: screw  
 Packaging: bulk  
 PU: 100 piece(s)

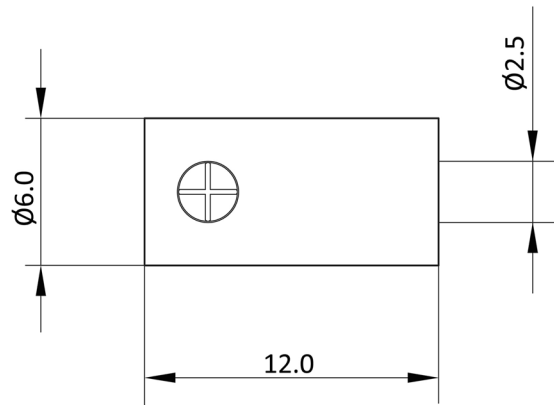

**Order Information**

Identifier:	Colour:
<b>HOK25</b>	<b>#</b>
HO jack 2.5 mm	<b>SW:</b> black
	<b>RT:</b> red
	<b>BL:</b> blue
	<b>GE:</b> yellow
	<b>GN:</b> green
	<b>WS:</b> white