

50.612 PA/SWL

Perfect cable gland PA/SW long thread M12X1,5 thread length 15, min/max cable dia 3-6 Body - Polyamide PA6 V-2

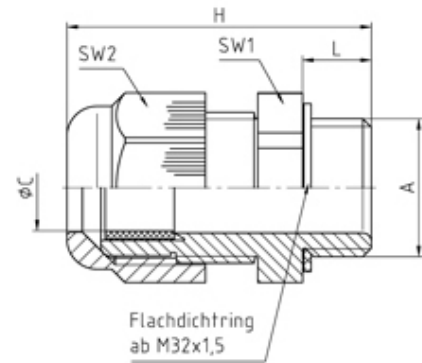

SPECIFICATION

Product Type	Standard
Sealing Ring Material	Polychloroprene-Nitrile rubber CR/NBR
Body Material	Polyamide
Min Temperature °C	-20
Max Temperature °C	100
IP Rating	68
Colour	Black - RAL 9005
Thread Size	M12
Clamping Range Min (mm)	3
Clamping Range Max (mm)	6
External Connecting Thread Type	Metric
Thread Length (mm)	15
Comments	details about tests - see annex
Width Across Flat 1 (mm)	15
Width Across Flat 2 (mm)	15
Height (mm)	38
Connecting Thread Size	M12x1.5
Additional Material Detail	Body - Polyamide PA6 V-2
Standards	EN50262/UL514B