

**DYMO**<sup>®</sup>



User Guide

LabelManager<sup>®</sup> 280

**Copyright**

© 2012 Newell Rubbermaid, LLC. All rights reserved.

No part of this document or the software may be reproduced or transmitted in any form or by any means or translated into another language without the prior written consent of Newell Rubbermaid, LLC.

**Trademarks**

DYMO, DYMO Label, and LabelManager are registered marks in the US and other countries. All other trademarks are the property of their respective holders.

# Contents

<b>About Your New Label Maker</b> .....	<b>5</b>
Product Registration .....	5
<b>Getting Started</b> .....	<b>5</b>
Connecting the Power .....	5
Inserting the Battery Pack .....	5
Recharging the Battery Pack .....	5
Removing the Battery .....	5
Inserting the Label Cassette .....	6
<b>Using the Label Maker for the First Time</b> .....	<b>6</b>
<b>Getting to Know the Label Maker</b> .....	<b>6</b>
Power .....	6
LCD Display .....	7
Navigation Keys .....	7
Cancel .....	7
Backspace .....	7
Caps Mode .....	7
New Label/Clear .....	7
Text Size .....	7
Format Keys .....	7
Vertical Text .....	7
Menu .....	7
<b>Formatting Your Label</b> .....	<b>7</b>
Changing the Font Type .....	7
Changing the Text Size .....	8
Changing the Text Style .....	8
Adding Borders .....	8
Using Mirror Text .....	8
Creating Vertical Labels .....	8
Creating Fixed-Length Labels .....	9
Aligning the Text .....	9
Creating Two-Line Labels .....	9
<b>Using Clip Art, Symbols, and Special Characters</b> .....	<b>9</b>
Adding Symbols .....	9
Adding Clip Art .....	10
Adding Accented Characters .....	10
Inserting the Date and Time .....	10
Using Auto-Numbering .....	11
Deleting Auto-Numbering .....	11
<b>Changing the Settings</b> .....	<b>11</b>
Changing the Language .....	11
Setting the Label Width .....	11
<b>Press or toPrinting Options</b> .....	<b>11</b>
Previewing Your Label Layout .....	11
Printing Multiple Labels .....	11
<b>Using the Label Maker Memory</b> .....	<b>11</b>
Saving a Label .....	11
Opening Saved Labels .....	11
Inserting Saved Text .....	12
<b>Caring for Your Label Maker</b> .....	<b>12</b>
<b>Using the Label Maker with Your Computer</b> .....	<b>13</b>
Installing DYMO Label Software .....	13
Connecting the Label Maker to your Computer .....	13
Using DYMO Label Software .....	14
Viewing the Label Maker Status .....	14
<b>Troubleshooting</b> .....	<b>15</b>
<b>Documentation Feedback</b> .....	<b>16</b>
<b>Environmental Information</b> .....	<b>16</b>
<b>Safety Precautions for Lithium-Ion Rechargeable Battery Pack</b> .....	<b>17</b>

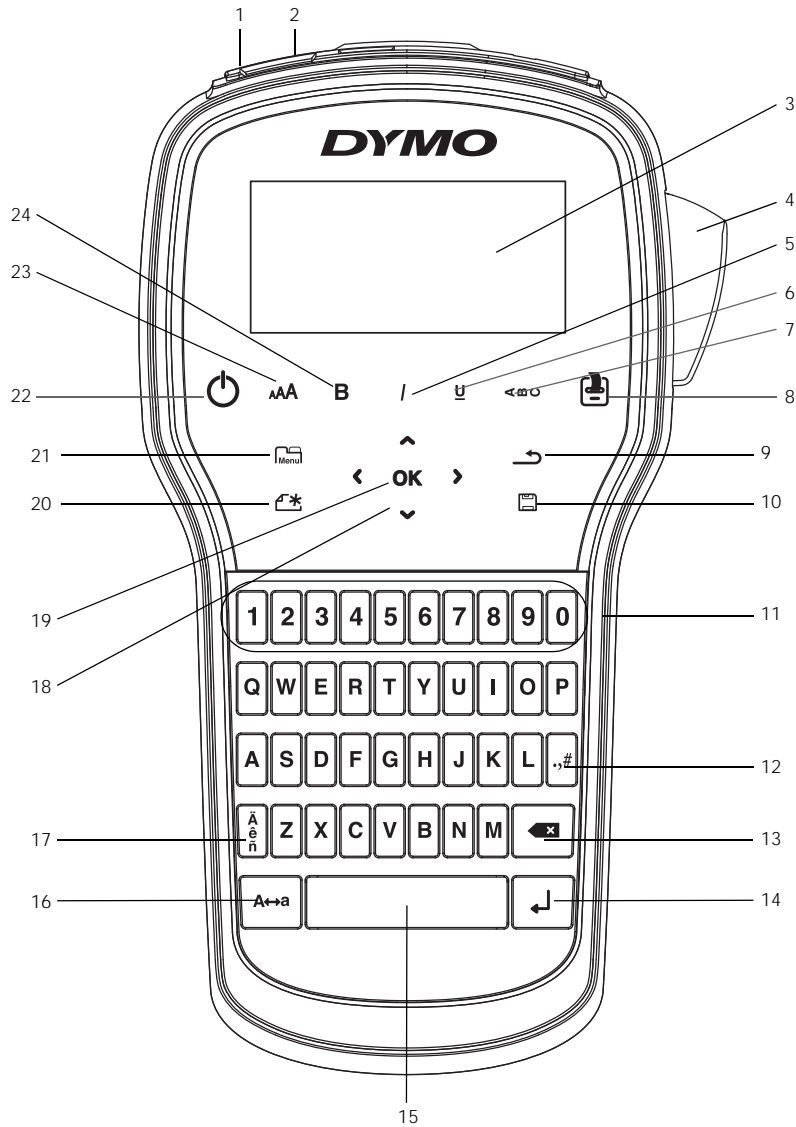

Figure 1 LabelManager 280 Label Maker

- |                        |                        |                               |
|------------------------|------------------------|-------------------------------|
| <b>1</b> USB port      | <b>9</b> Back          | <b>17</b> Accented characters |
| <b>2</b> Power port    | <b>10</b> Save/Open    | <b>18</b> Navigation          |
| <b>3</b> LCD display   | <b>11</b> Numeric keys | <b>19</b> OK                  |
| <b>4</b> Cutter        | <b>12</b> Symbols      | <b>20</b> New label/Clear     |
| <b>5</b> Italics       | <b>13</b> Backspace    | <b>21</b> Menu                |
| <b>6</b> Underline     | <b>14</b> Return       | <b>22</b> On/Off              |
| <b>7</b> Vertical text | <b>15</b> Space bar    | <b>23</b> Text size           |
| <b>8</b> Print/Copies  | <b>16</b> Caps         | <b>24</b> Bold                |

## About Your New Label Maker

With the DYMO® LabelManager® 280 electronic label maker, you can create a wide variety of high-quality, self-adhesive labels. You can choose to print your labels in several different fonts, text sizes, and text styles. The label maker uses DYMO D1 label cassettes in widths of 1/4", 3/8", or 1/2". These label cassettes are available in a wide range of colors.

Visit [www.dymo.com](http://www.dymo.com) for information on obtaining labels and accessories for your label maker.

## Product Registration

Visit [www.dymo.com/register](http://www.dymo.com/register) to register your label maker online. During the registration process, you will need the serial number, which is located inside the back cover of the label maker.

Register your label maker to receive these benefits:

- Notification of software upgrades by email
- Special offers and new product announcements

## Getting Started

Follow the steps in this section to print your first label.

### Connecting the Power

The label maker is powered by a rechargeable, lithium-ion (Li-ion) battery pack. To save power, the label maker automatically turns off after two minutes of inactivity.

 Remove the battery pack if the label maker will not be used for a long period of time.

### Inserting the Battery Pack

The battery pack included with your label maker comes partially charged. For best performance, fully charge the battery as soon as possible.

 Make sure the charging adapter is disconnected before handling the Li-ion battery pack.

### To insert the battery pack

- 1 Slide the battery compartment cover away from the label maker. See Figure 2.

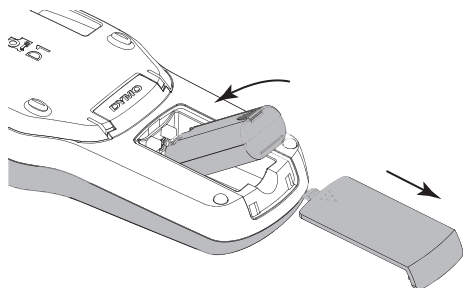



Figure 2

- 2 Insert the battery pack into the battery compartment.
- 3 Replace the battery compartment cover.

 Make sure to read the Li-ion Safety Precautions found on page 17.

## Recharging the Battery Pack

A charging adapter is included with your label maker for recharging the battery pack. Charging the battery pack will take approximately three hours; however, after charging for about 10 minutes, the label maker can be used to print labels.

 The charging adapter is only used for recharging the battery pack; the charging adapter cannot be used to power the label maker.

### To recharge the battery pack

- 1 Plug the charging adapter into the power connector on the top of the label maker.
- 2 Plug the other end of the charging adapter into a power outlet. See Figure 3.

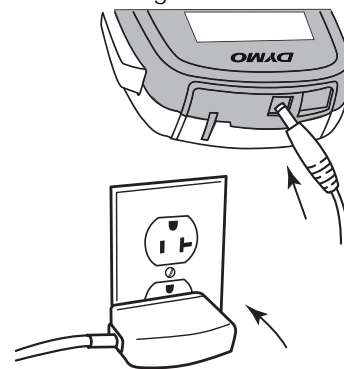



Figure 3

 Make sure to read the Li-ion Safety Precautions found on page 17.

### Removing the Battery

Remove the battery pack if the label maker will not be used for a long period of time.

 Make sure the charging adapter is disconnected before handling the Li-ion battery pack.

### To remove the battery

- 1 Unplug the charging adapter.
- 2 Slide the battery compartment cover away from the label maker. See Figure 2.
- 3 Remove the battery from the battery compartment.

 Make sure to read the Li-ion Safety Precautions found on page 17.

## Inserting the Label Cassette

Your label maker comes with a starter label cassette. The label maker uses DYMO D1 label cassettes in widths of 1/4", 3/8", or 1/2". Visit [www.dymo.com](http://www.dymo.com) for information about purchasing additional label cassettes.

### To insert the label cassette

- 1 Lift the label cassette cover to open the label compartment. See Figure 4.

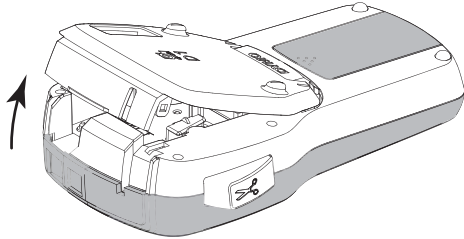

Figure 4

- 2 Make sure the tape and ribbon are taut across the mouth of the cassette and that the tape passes between the label guides. See Figure 5.

If necessary, turn the ribbon rewind spool clockwise to tighten the ribbon.

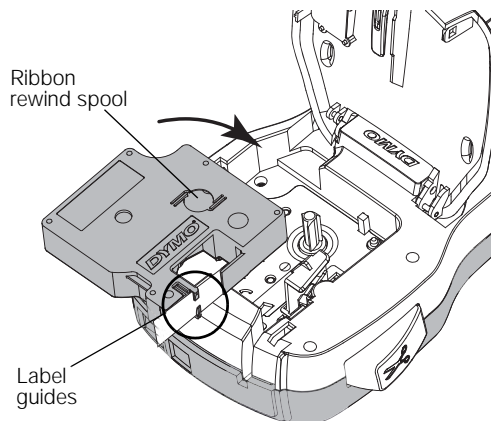

Figure 5

- 3 Insert the cassette and press firmly until cassette clicks into place. See Figure 6.

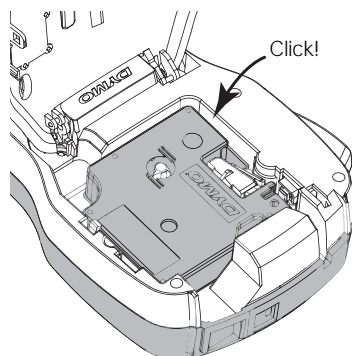



Figure 6

- 4 Close the label cassette cover.

## Using the Label Maker for the First Time

The first time you turn on the power, you are asked to select the language and label width. These selections remain set until you change them.

You can change these selections by pressing  and then selecting .

### To set up the label maker

- 1 Press  to turn on the power.
- 2 Select the language and press **OK**.
- 3 Select the width of the label cassette currently in the label maker and press **OK**.

 Each time you insert a label cassette into the label maker, you are prompted to set the label width so the label maker knows what size label you are currently using.

You are now ready to print your first label.

### To print a label

- 1 Using the keyboard, enter text to create a simple label.
- 2 Press . The label prints.
- 3 Press the cutter button to cut the label.
- 4 Remove the backing from the label to expose the adhesive, and then attach the label.

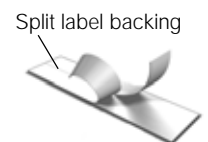

**Congratulations!** You have printed your first label. Continue reading to learn more about the features available for creating labels.

## Getting to Know the Label Maker

Become familiar with the location of the feature and function keys on your label maker. Refer to Figure 1 on page 4. The following sections describe each feature in detail.

### Power

The  button turns the power on and off. After two minutes of inactivity, the power is switched off automatically.

When the power is switched off either manually or automatically, the label text and style settings for the last label are remembered and displayed when the power is turned back on.

## LCD Display

With DYMO's exclusive graphical display, most of the formatting you add is visible instantly.

Feature indicators along the top and side of the LCD display appear in black to indicate when a feature is selected.

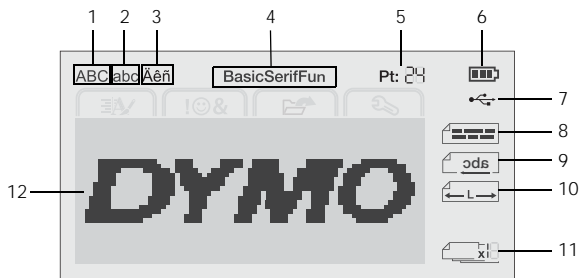

- |                      |                       |
|----------------------|-----------------------|
| 1 Uppercase          | 7 USB connected       |
| 2 Lowercase          | 8 Text alignment      |
| 3 Accented character | 9 Mirror text         |
| 4 Font               | 10 Fixed-length label |
| 5 Text size          | 11 Auto-numbering     |
| 6 Battery indicator  | 12 Edit area          |

## Navigation Keys

You can navigate through menu selections using the navigation keys: **<**, **>**, **^**, and **v**. You then press **OK** to make a selection. You can also review and edit your label using the navigation keys.

## Cancel

Pressing **↶** exits a menu without making a selection.

## Backspace

Pressing **⌫** removes the character to the left of the cursor.

## Caps Mode

Pressing **A↔a** toggles capitalization on or off. When Caps mode is on, all letters that you enter are capitalized. The default setting is Caps mode on. When Caps mode is off, all letters appear in lowercase.

## New Label/Clear

The **⌫\*** key gives you the option to clear the label text and keep the formatting, or to clear both the text and the formatting.

## Text Size

Pressing **AA** changes the size of the label text, the current text size is displayed on the LCD display.

## Format Keys

Pressing **B**, **I**, or **U** toggles bold, italic, and underline on or off.

## Vertical Text

Pressing **↶↷** toggles vertical text on or off.

## Menu

Pressing **Menu** displays the Format, Insert, Open, and Settings tabs. Use the options on these tabs to change the label appearance, insert clip art and symbols, open saved text and labels, and change the printer settings.

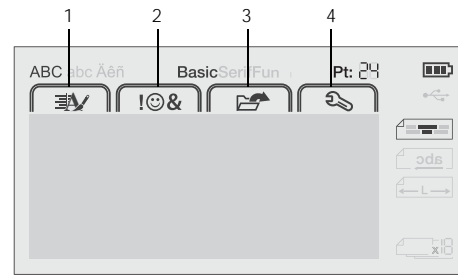

- |              |                |
|--------------|----------------|
| 1 Format tab | 3 Open tab     |
| 2 Insert tab | 4 Settings tab |

## Formatting Your Label

You can choose from several format options to enhance the appearance of your labels.

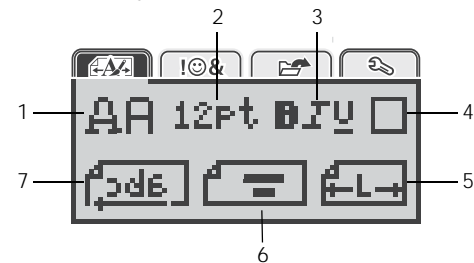

- |              |                  |
|--------------|------------------|
| 1 Font type  | 5 Label length   |
| 2 Text size  | 6 Text alignment |
| 3 Text style | 7 Mirror text    |
| 4 Borders    |                  |

## Changing the Font Type

Three font types are available for your labels:

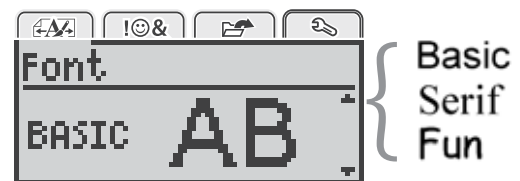

## To change the font type

- 1 Press **Menu**, select **Font**, and then press **OK**.
- 2 Select **AA**, and then press **OK**.
- 3 Press **^** or **v** to select the font type, and then press **OK**.

## Changing the Text Size

Six text sizes are available for your labels:



The text sizes available depend on the label width you have selected.

For single-line labels:

Label Width	Text Size Available
1/4"	8, 10, 12 point
3/8"	8, 10, 12, 16, 20 point
1/2"	8, 10, 12, 16, 20, 24 point

For two-line labels:

Label Width	Text Size Available
3/8"	8, 10 point
1/2"	8, 10, 12 point

The text size applies to all characters on a label.

### To change the text size

- 1 Press **Menu**, select **AA**, and then press **OK**.
- 2 Select the current text size, and then press **OK**.
- 3 Press **<** or **>** to select the text size, and then press **OK**.

💡 You can also quickly change the text size using the text size key, **AAA**.

## Changing the Text Style

You can choose from six text styles:

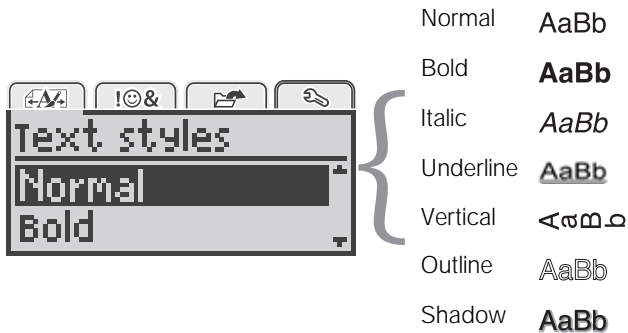

Normal	AaBb
Bold	<b>AaBb</b>
Italic	<i>AaBb</i>
Underline	<u>AaBb</u>
Vertical	⊲⊳⊴⊵
Outline	⊲⊳⊴⊵
Shadow	⊲⊳⊴⊵

### To change the text style

- 1 Press **Menu**, select **AA**, and then press **OK**.
- 2 Select **B I U**, and then press **OK**.
- 3 Press **^** or **v** to select the text style, and then press **OK**.

💡 You can also quickly apply a text style using the formatting keys, **B**, **I**, or **U**.

Some text styles can be combined. Use the formatting keys to combine styles.

When using underline on multi-line labels, each line is underlined.

## Adding Borders

You can highlight the text by adding a border style.

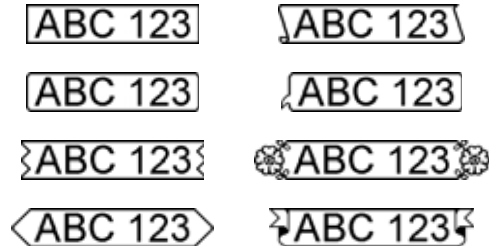

### To add a border

- 1 Press **Menu**, select **AA**, and then press **OK**.
- 2 Select **□**, and then press **OK**.
- 3 Press **^** or **v** to select the border style, and then press **OK**.

When using borders on two-line labels, both lines are enclosed in one border.

### Using Mirror Text

The mirror format allows you to print text which reads from right to left, as you would see the text in a mirror.



### To apply mirror text

- 1 Press **Menu**, select **AA**, and then press **OK**.
- 2 Select **⊲⊳⊴⊵**, and then press **OK**.
- 3 Press **<** or **>** to select **⊲⊳⊴⊵**, and then press **OK**.

## Creating Vertical Labels

You can print text with the text oriented so that you can read the label vertically.

### To create a vertical label

- 1 Press **⊲⊳⊴⊵**.
  - 2 Enter text.
  - 3 Press **⊲** to print.
- 📄 The underline style will not print on a vertical label.



## Creating Fixed-Length Labels

Normally, the length of the label is automatically determined by the length of the text. However, you can choose to set the length of the label for a specific application.

When you choose a fixed label length, the size of the label text is automatically adjusted to fit the label. If the text cannot be adjusted to fit within the fixed label length, a message is displayed and you are prompted to print a variable length label. You can choose a fixed length label between 1.5" and 15" long.

### To set a fixed length

- 1 Press , select , and then press **OK**.
- 2 Select , and then press **OK**.
- 3 Press < or > to select **Fixed**.



- 4 Press  $\wedge$  or  $\vee$  to select the label length, or use the numeric keys to enter the label length.
- 5 Press **OK**.

The fixed-length setting remains on until you change back to variable length.

### Aligning the Text

You can align the text to print left or right justified on the label. The default alignment is centered.

Text alignment settings are only valid for fixed-length labels. Variable-length labels are always center aligned.



### To change the text alignment

- 1 Press , select , and then press **OK**.
- 2 Select , and then press **OK**.
- 3 Press < or > to select the text alignment, and then press **OK**.

## Creating Two-Line Labels

You can print a maximum of two lines on a label. Only one line of text can be printed on 1/4" (6 mm) labels.

When printing a two-line vertical label, the second line of text will print to the right side of the first line.

### To create a two-line label

- 1 Type the text for the first line and press  $\leftarrow$ .
- 2 Type the text for the second line.
- 3 Press to print.

## Using Clip Art, Symbols, and Special Characters

Clip art, symbols, punctuation, and other special characters can be added to your labels.

### Adding Symbols

The label maker supports the extended symbol set shown below.

?	!	—	-	:
'	"	,	.	;
'	ı	¿	/	\
&	@	#	%	‰
	(	)	{	}
[	]	°	•	*
+	-	x	÷	√
^	~	≈	=	≠
±	<	>	≤	≥
€	£	\$	¢	¥
©	®	©	™	§
1/3	2/3	1/8	5/8	7/8
1/4	1/2	3/4	3/8	
0	1	2	3	4
5	6	7	8	9
0	1	2	3	4
5	6	7	8	9
α	β	γ	δ	ε
ζ	η	θ	ι	κ
λ	μ	ν	ξ	ο
π	ρ	σ	τ	υ
φ	χ	ψ	ω	
A	B	Γ	Δ	E
Z	H	Θ	I	K
Λ	M	N	Ξ	O
Π	P	Σ	T	Υ
Φ	X	Ψ	Ω	

### To insert a symbol

- 1 Press , select , and then press **OK**.
- 2 Select **Symbols**, and then press **OK**.
- 3 Press the navigation keys to select a symbol.
- 4 Press **OK** to add the symbol to your label.

💡 You can quickly add a symbol by pressing the **.,#** key.

## Adding Clip Art

The label maker includes the clip art shown below.

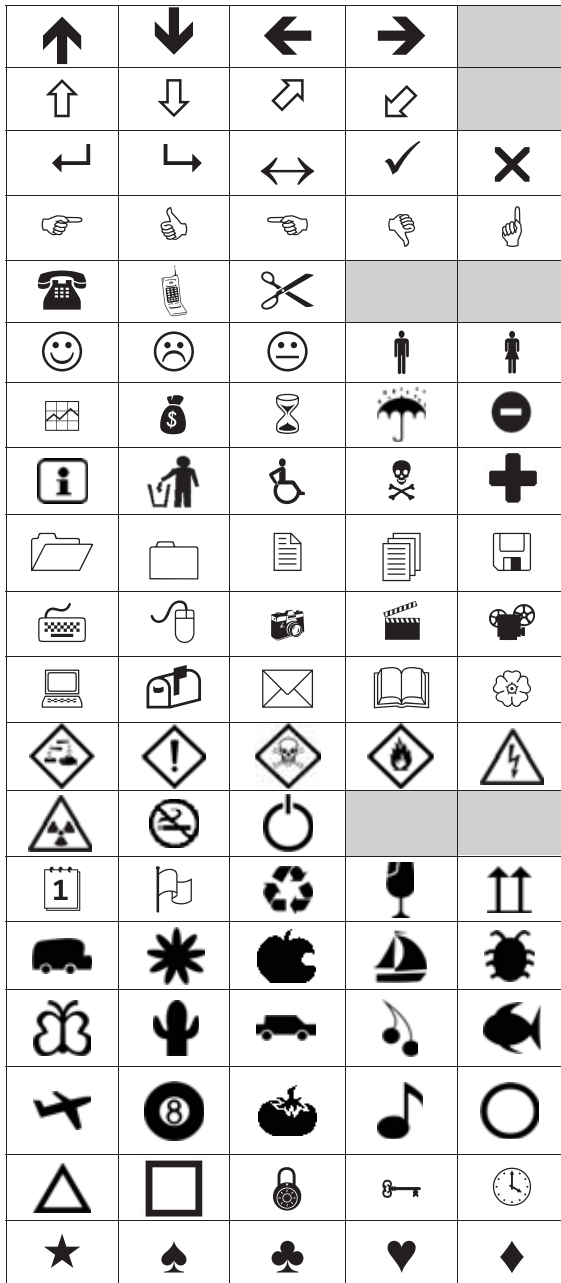

### To insert clip art

- 1 Press **Menu**, select , and then press **OK**.
- 2 Select **Clip Art**, and then press **OK**.
- 3 Press the navigation keys to select an image.
- 4 Press **OK** to add the image to your label.

## Adding Accented Characters

The label maker supports the extended Latin character set. You can add accented characters in two ways:

- Press  and then the alpha character.
- Press and hold the alpha character.

After pressing the alpha character, all of the available variations of that letter are displayed.

For example, if you press and hold the letter **a**, you will see **a â ã ä å** and so on through all the variations available.



### To add accented characters

- 1 Press and hold an alpha character.  
The accent variations for that character are displayed.
- 2 Press **<** or **>** to select the character you want, and then press **OK**.



## Inserting the Date and Time

You can insert the current date and time on your label. The date and time format depends on the format you have selected in the label maker settings.



### To set the date and time format

- 1 Press **Menu**, select , and then press **OK**.
- 2 Select , and then press **OK**.
- 3 Select **Notation**, and then press **OK**.
- 4 Select the date or date and time format to use, and then press **OK**.

### To set the date

- 1 Press **Menu**, select , and then press **OK**.
- 2 Select , and then press **OK**.
- 3 Select **Set date**, and then press **OK**.
- 4 Use the navigation keys to select the current day, month, and year.
- 5 Press **OK**, and then press  twice to return to the edit area.

### To set the time

- 1 Press **Menu**, select , and then press **OK**.
- 2 Select , and then press **OK**.
- 3 Select **Set time**, and then press **OK**.
- 4 Use the navigation keys to select the current hour and minutes.
- 5 Press **OK**, and then press  twice to return to the edit area.

### To insert the date and time

- 1 Press **Menu**, select , and then press **OK**.
- 2 Select **Date and Time**, and then press **OK**.  
The date and time are inserted on the label.

## Using Auto-Numbering

You can print a series of up to 10 labels at a time using auto-numbering.

You can add numeric (0,1, 2...9), uppercase (A, B, C...Z), or lowercase (a, b, c...z) auto-numbering to your label. Optionally, you can add text before and after the auto-numbering.

### To auto-number your labels

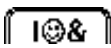
- 1 Press , select , and then press **OK**.
- 2 Select **Auto-numbering**, and then press **OK**.
- 3 Select the auto-numbering type to use, and then press **OK**.
- 4 Use the navigation keys to select a start and end value, and then press **OK**.

Auto-numbering is added to your label and the number of labels in the series is shown on the LCD display.



## Deleting Auto-Numbering

Auto-numbering is entered on the label as one character.

### To delete auto-numbering

- 1 Place the cursor at the end of the auto-numbering text on the display.
- 2 Press .



## Changing the Settings

Several options are available for customizing your label maker. You can choose the display language and set the width of the label.

### Changing the Language

You can change the display language for the label maker so that you can work in a language that is most familiar to you.

#### To change the language



- 1 Press , select , and then press **OK**.
- 2 Select the current language, and then press **OK**.
- 3 Press **^** or **v** to select the desired language, and then press **OK**.

### Setting the Label Width

Each time you insert a label cassette into the label maker, you are prompted to set the label width so the label maker knows what size label you are currently using.

Some of the features available for designing labels depend on the width of the label. You can change the label width setting at any time, regardless of what label cassette is actually inserted in the label maker.

### To change the label width setting

- 1 Press , select , and then press **OK**.
- 2 Select the current label width, and then press **OK**.
- 3 Press **<** or **>** to select the desired label width, and then press **OK**.

### Press **<** or **>** to **Printing Options**

You can preview your label layout or print multiple copies.

### Previewing Your Label Layout

You can preview the size and layout of your label prior to printing.

#### To preview your label layout

- ▶ Press  and hold for a few seconds.

The label length, width, and layout information are displayed.

### Printing Multiple Labels

You can print up to ten copies of a label.

#### To print multiple labels

- 1 Press  and hold for a few seconds.
- 2 Press **^** or **v** to select the number of copies to print, and press **OK**.

When printing is finished, the number of copies to print returns to the default value of 1.

## Using the Label Maker Memory

The label maker has a powerful memory feature that allows you to save the text of up to nine frequently used labels. You can recall saved labels, and you can also insert saved text into the current label.

### Saving a Label

You can save up to nine frequently used labels. When you save a label, the text and any formatting are saved.

#### To save the current label



- 1 Press .  
The first available memory location is displayed.
- 2 Use the navigation keys to move through the locations.  
You can store a new label in any of the memory locations.
- 3 Select a memory location, and then press **OK**.

Your label is saved and you are returned to the label.

### Opening Saved Labels

You can easily open labels that are saved in memory.

#### To open saved labels

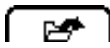
- 1 Do one of the following:
  - Press and hold  for a few seconds.
  - Press  and then select .The first memory location is displayed.
- 2 Press **^** or **v** to select a label, and then press **OK**.

The selected label is opened in the edit area.

### Inserting Saved Text

You can insert the text of a saved label into the current label. Only the saved text is inserted, not the formatting.

#### To insert saved text

- 1 Position the cursor at the location in the label where you want to insert the text.
- 2 Press **Menu**, select **I&O**, and then press **OK**.
- 3 Press **Λ** or **V** to select **Saved text**, and then press **OK**.  
The first memory location is displayed.
- 4 Press **Λ** or **V** to select the text to insert, and then press **OK**.

The text is inserted in the current label.

### Caring for Your Label Maker

Your label maker is designed to give you long and trouble-free service, while requiring very little maintenance.

Clean your label maker from time to time to keep it working properly. Clean the cutter blade each time you replace the label cassette.

#### To clean the cutter blade

- 1 Remove the label cassette.
- 2 Press and hold the cutter button to expose the cutter blade. See Figure 7.

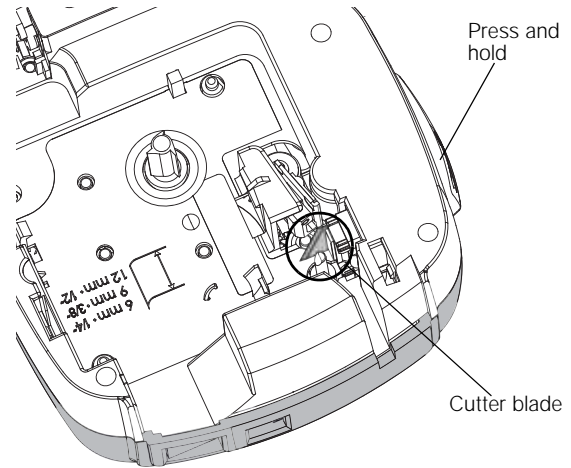

Figure 7

- 3 Use a cotton swab and alcohol to clean both sides of the blade.

**!** The cutter blade is extremely sharp. Use caution when cleaning.

#### To clean the print head

- 1 Remove the label cassette.
- 2 Remove the cleaning tool from inside the label compartment cover. See Figure 8.
- 3 Gently wipe the padded side of the tool across the print head. See Figure 8.

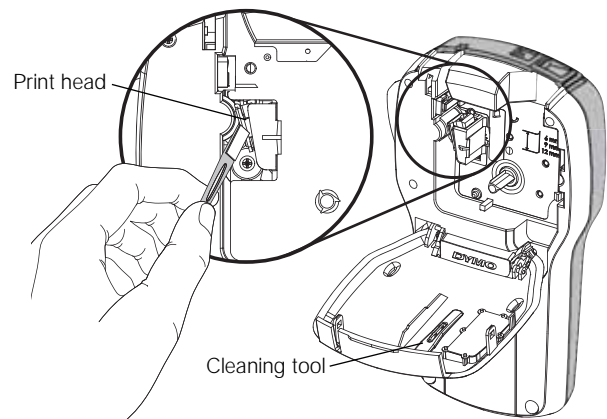

Figure 8

## Using the Label Maker with Your Computer

The label maker can be used as a standalone label printer or you can print labels directly from your computer using the latest version of DYMO Label™ software.

### Installing DYMO Label Software

Do not connect the label maker to your computer until prompted by the software installer.

#### To install the software on a Windows® system

- 1 Download the latest version of DYMO Label software from [LM280.dymo.com](http://LM280.dymo.com).
- 2 Close all open Microsoft Office applications.
- 3 Double-click the Installer icon.  
After a few seconds, the installation screen appears.
- 4 Click **Install** and follow the instructions in the installer.

#### To install the software on a Mac OS® system

- 1 Download the latest version of DYMO Label software from [LM280.dymo.com](http://LM280.dymo.com).
- 2 Double-click the Installer icon and follow the on-screen instructions.

## Connecting the Label Maker to your Computer

The label maker connects to your computer using the USB connection located on the top of the label maker.



Do not connect the label maker to your computer until prompted by the software installer.



Figure 9

### To connect the label maker to your computer

- 1 Plug the USB cable into the USB port on the top of the label maker. See Figure 9.
- 2 Plug the other end of the USB cable into an available USB port on your computer.
- 3 Press  to turn on the label maker.
- 4 If you have more than one DYMO label printer installed, do the following:
  - a Click the printer image in the DYMO Label software Print area.



All of the label printers that are installed on your computer are displayed.

- b Select the **LabelManager 280** label maker.

You are now ready to print labels from DYMO Label software.

For more information, see **Using DYMO Label Software** on the next page.

## Using DYMO Label Software

The following figure shows some of the major features available in DYMO Label software.

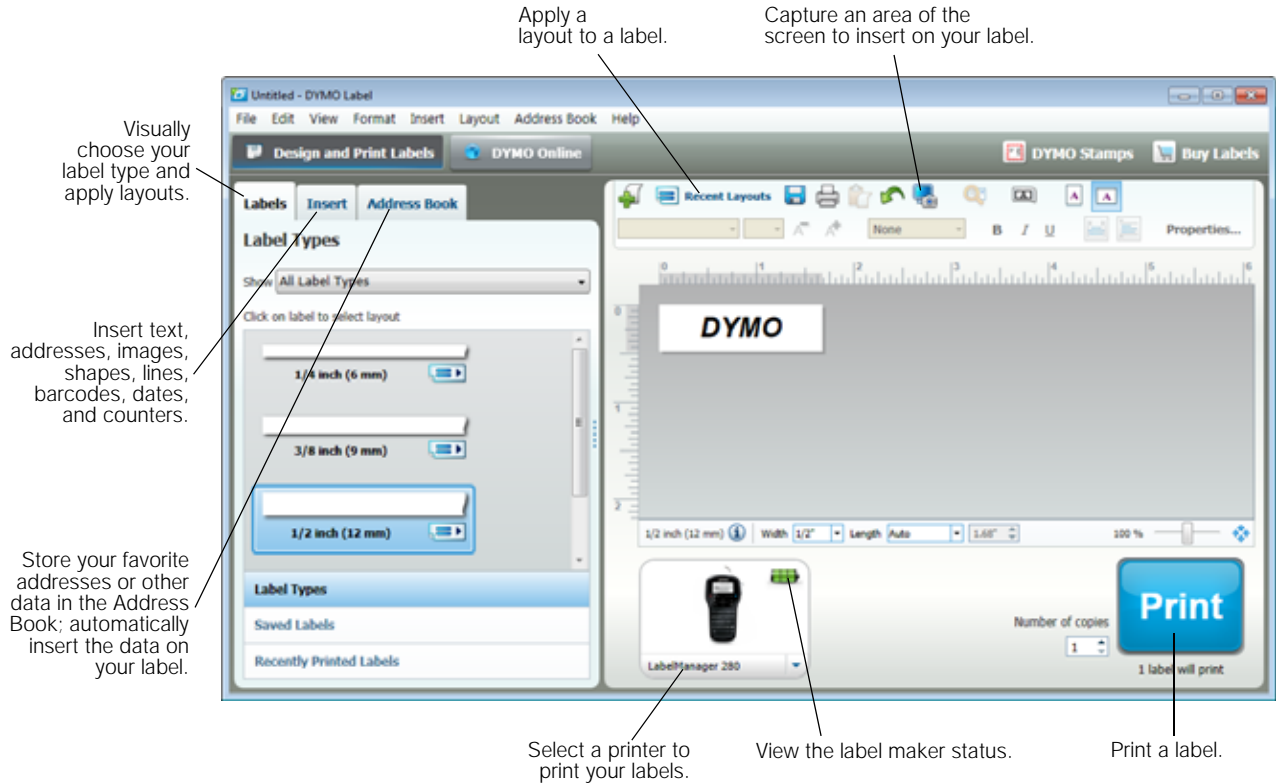

For complete details on using the software, refer to the online Help.

From the Help menu, you can view the following:

- DYMO Label Help
- DYMO Label User Guide
- LabelManager 280 User Guide

### Viewing the Label Maker Status

The label maker status is displayed in the DYMO Label software Print area. The following table describes the possible states of the label maker.

	Label maker is connected and battery pack is charging
	Label maker is connected and battery pack is charging; printing is not possible
	Label maker is connected and battery pack is not charging
	Label maker is connected and battery pack is not charging; printing is not possible
	Label maker is not connected or is turned off
	Label maker is connected and there is a problem with the battery pack

## Troubleshooting

Review the following possible solutions if you encounter a problem while using your label maker.

Problem/Error Message	Solution
No display	<ul style="list-style-type: none"> <li>Ensure the label maker is turned on.</li> <li>Attach the charging adapter to the label maker to recharge the battery pack. See <b>Recharging the Battery Pack</b>.</li> </ul>
Poor Print Quality	<ul style="list-style-type: none"> <li>Attach the charging adapter to the label maker to recharge the battery pack. See <b>Recharging the Battery Pack</b>.</li> <li>Clean the print head. See <b>Caring for Your Label Maker</b>.</li> <li>Ensure the label cassette is installed properly.</li> <li>Replace the label cassette.</li> </ul>
Auto-numbering already inserted	<ul style="list-style-type: none"> <li>Auto-numbering already appears on the label and cannot be added more than once to the same label.</li> </ul>
Battery failure! Battery pack not inserted properly or damaged.	<ul style="list-style-type: none"> <li>Ensure the battery pack is inserted correctly. See <b>Inserting the Battery Pack</b>.</li> <li>Replace the battery pack.</li> </ul>
Wait <i>n</i> minutes Battery is charging	<ul style="list-style-type: none"> <li>Allow the battery pack to recharge before unplugging the label maker. See <b>Recharging the Battery Pack</b>.</li> </ul>
Too Many Characters! Exceeded maximum number of characters in the buffer.	<ul style="list-style-type: none"> <li>Delete some or all of the buffer text.</li> <li>Decrease the text size.</li> <li>Delete lines to fit on the label width.</li> <li>Insert a wider label cassette.</li> </ul>
No label found. Insert label cartridge No cartridge is present.	<ul style="list-style-type: none"> <li>Open the cartridge compartment and insert a label cartridge. See <b>Inserting the Label Cassette</b>.</li> </ul>
Label Jam Remove cartridge Motor is stalled due to label jam.	<ul style="list-style-type: none"> <li>Open the label cartridge compartment and remove the cartridge.</li> <li>Remove jammed label, clearing the jam.</li> <li>Clean the cutter blade. See <b>Caring for Your Label Maker</b>.</li> <li>Make sure the label passes smoothly through the label guides on the label cartridge and that the label and ribbon are taut across the mouth of the cartridge. See <b>Inserting the Label Cassette</b>.</li> </ul>
Printing...	<ul style="list-style-type: none"> <li>No action required. Message disappears when printing is finished.</li> </ul>
Label length exceeds fixed length Print label with variable length?	<ul style="list-style-type: none"> <li>Press <b>OK</b> to print a variable length label.</li> <li>Delete some or all of the buffer text.</li> <li>Decrease the text size.</li> <li>Delete lines to fit on the label width.</li> <li>Insert a wider label cassette.</li> </ul>
Too many lines for the selected label width	<ul style="list-style-type: none"> <li>Delete some or all of the buffer text.</li> <li>Decrease the text size.</li> <li>Delete lines to fit on the label width.</li> <li>Insert a wider label cassette.</li> <li>Change to a variable length label.</li> </ul>
Label length exceeds fixed length	<ul style="list-style-type: none"> <li>Delete some text.</li> <li>Print the label using variable length.</li> </ul>
Charge Battery!	<ul style="list-style-type: none"> <li>Attach the charging adapter to the label maker to recharge the battery pack. See <b>Recharging the Battery Pack</b>.</li> <li>Ensure the battery pack is inserted correctly. See <b>Inserting the Battery Pack</b>.</li> <li>Replace the battery pack.</li> </ul>
How do I remove the backing from the label?	<p>DYMO labels have an easy-to-peel split back.</p> <ol style="list-style-type: none"> <li>1 Locate the split on the label backing.</li> <li>2 Gently pinch the label lengthwise, folding toward the printed side of the label. The label backing will separate.</li> <li>3 Carefully peel away the backing from the label.</li> </ol>

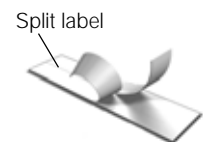

If you need further assistance, visit the DYMO Web site at [www.dymo.com](http://www.dymo.com).

## Documentation Feedback

We are constantly working to produce the highest quality documentation for our products. We welcome your feedback. Send us your comments or suggestions about our user guides. Please include the following information with your feedback:

- Product name, model number, and User Guide page number
- Brief description of instructions that are inaccurate or unclear, areas where more detail is needed, and so on

We also welcome your suggestions about additional topics you would like to see covered in the documentation.

Send email messages to: **documentation@dymo.com**

Please keep in mind that this email address is only for documentation feedback. If you have a technical question, please contact Customer Support.

## Environmental Information

The equipment that you have bought requires the extraction and use of natural resources for its production. It may contain substances that are hazardous to health and the environment.

In order to avoid the dissemination of those substances in our environment, and to diminish the pressure on natural resources, we encourage you to use the appropriate take-back systems. These systems will reuse or recycle most of the materials of your end-of-life equipment in an environmentally sound way.

The crossed-bin symbol marked on your device indicates you should use these systems.



If you need more information on the collection, reuse, and recycling of this product, please contact your local or regional waste administration.

You can also contact DYMO for more information on the environmental performance of our products.



## Safety Precautions for Lithium-Ion Rechargeable Battery Pack

Inaccurate handling of a Lithium-ion rechargeable battery may cause leakage, heat, smoke, an explosion, or fire. This could cause deterioration of performance or failure. This may also damage the protection device installed in the battery pack. This could damage equipment or injure users. Thoroughly follow the instructions below.

### While Charging the Battery Pack

---

#### **DANGER**

To reduce the risks associated with fire and explosion, which if not avoided, could result in serious injury or death:

- Danger of explosion if a battery is incorrectly handled, charged, disposed or replaced. Replace only with the same or equivalent type recommended by DYMO.
  - When charging the battery, use dedicated chargers and follow the specified conditions.
  - Do not connect directly to an electric outlet or cigarette lighter charger.
  - Do not store the battery close to fire or at extremely high temperatures over 60°C (for example, a vehicle, strong direct sunlight).
  - Do not short-circuit the batteries under any circumstances.
  - Never charge batteries near highly flammable objects.
- 

#### **WARNING**

To reduce the risks associated with fire and explosion, which if not avoided, could result in serious injury or death and/or property damage:

- Stop charging the battery if charging is not completed within the specified time.
  - Never leave the batteries unattended during charging. Do not attempt to charge a cell that is damaged.
  - Immediately remove the battery from the device or battery charger and stop use if the battery gives off an odor, generates heat, becomes discolored or deformed, or in any way appears abnormal during use.
- 

#### **CAUTION**

To reduce the risks associated with various hazards, which if not avoided, may result in minor or moderate injury and/or property damage:

- Thoroughly read this document before charging the battery.
  - Lithium cells must be completely discharged before disposal.
  - Always dispose the batteries in a manner consistent with local, regional and national regulation.
  - Battery can only be charged within a temperature range of 0°C~45°C.
- 

### While Discharging the Battery Pack

---

#### **WARNING**

To reduce the risks associated with fire and explosion, which if not avoided, could result in serious injury or death and/or property damage:

- Use the battery only in the specified equipment.
  - Do not discharge the battery close to fire or at extremely high temperatures over 60°C (for example, a vehicle, strong direct sunlight).
- 

#### **CAUTION**

To reduce the risks associated with various hazards, which if not avoided, may result in minor or moderate injury and/or property damage:

- Battery can only be used within a temperature range of -20°C~60°C.
-