

Hydrocar ASSEMBLY GUIDE



Model No.: FCJJ-20

SKU: 550590

Warning

To avoid the risk of property damage, serious injury or death:

This kit should only be used by persons 12 years old and up, and only under the supervision of adults who have familiarized themselves with the safety measures described in the kit. Keep small children and animals away, as it contains small parts that could be swallowed. Read the instructions before use and have them ready for reference.

Hydrocar

ASSEMBLY GUIDE

What you need: ● Hydrocar ● AA batteries=2 Units ● Water=100ml ● Scissors

- Use the scissors to cut two lengths of 4cm(1.5 inches) of rubber tubing from the long rubber tubing provided in the kit.
Place the red pin into one of the 4cm tubes, and the black pin into the other 4cm tube. Cut the remaining long tube into two equal pieces.
- Remove the screw from battery box cover using a screw driver. Push and slide the cover to open the battery box. DO NOT touch the cables when you open the cover. Place two AA batteries as indicated. Push and slide the battery box cover to closed position and screw tightly into place using screw driver.

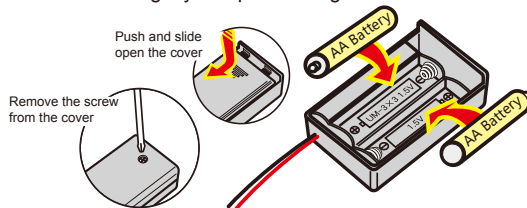

- ※ Make sure the switch on the battery box is in the "off" position before you place the batteries into the box.
- ※ WARNING: If the cable is short circuited the batteries inside could become hot and potentially cause burns, melting of parts, or create risk of fire.
- ※ Note: Battery's energy may be consumed after 4-5 times of use.

Battery operation instructions:

- The removing and inserting of batteries is to be conducted by the adults only. Unscrew the screw holding the battery pack's cover in place using a screw driver. Once the screw is removed open the battery pack and take out the batteries using your fingers. Do not use a metal object. When inserting the batteries make sure that you are doing so with the correct polarity (the positive end of the battery must match up with the "+" and the negative end of the battery must match up with the "-" indicated on the battery pack), close the battery pack and secure its cover by tightening the screw with a screw driver.
- Non-rechargeable batteries are not to be recharged.
- Different types of batteries such as rechargeable, alkaline and standard batteries or new and used batteries are not to be mixed and should be used separately.
- The battery pack cables are not to be inserted into an AC socket.
- The supply terminals of the battery pack are not to be short-circuited.
- The two spare red&black cables are not to be inserted into an AC socket.
- Exhausted batteries are to be removed from the battery pack.

- Connect the short tubes completely onto the short H₂/O₂ intake nozzles located on the lower sections of both "H₂" and "O₂" sides of the fuel cell.

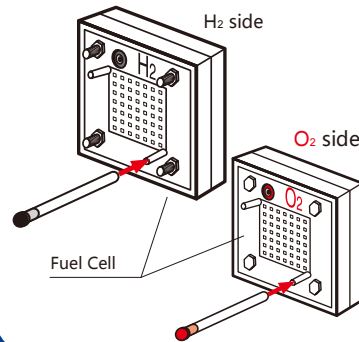

- Insert the fuel cell into the rectangular slot located on the car chassis.
- Place the Hydrogen outer storage cylinder into the round slot located on the right side of the chassis.
- Place the Oxygen outer storage cylinder into the round slot located on the left side of the chassis.

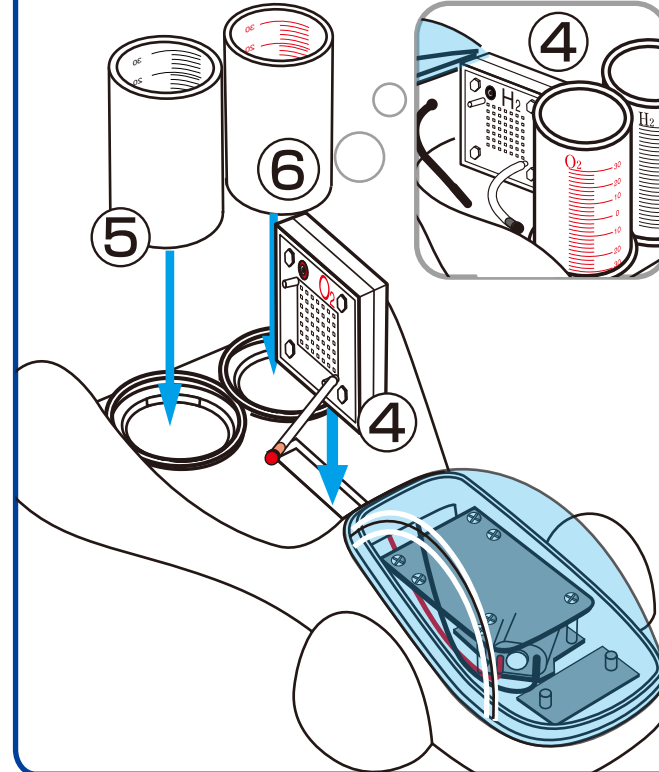

- Remove the cap from each tube connected to the fuel cell. Using the syringe, inject distilled water into the Oxygen side of the fuel cell until the fuel cell is HALF filled with water.
WARNING: The polymer membrane is an important part of the proton exchange membrane (PEM) fuel cell, it should be prevented from drying out.

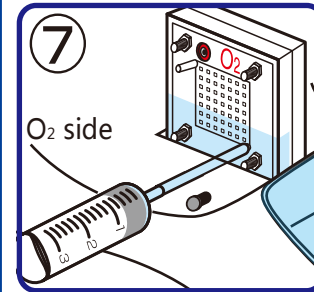

After water injection

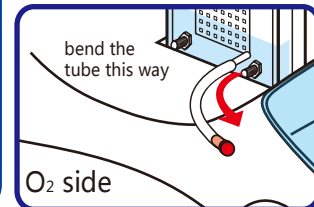

- First add water up to the "0" line. Place inner containers into outer cylinders minding that the gaps are not blocked by inner plastic rims. Make sure the water is still level to the "0" line. If not, remove some water with the syringe. Then connect the tubing to the inner containers. Make sure there is no air trapped inside the inner containers and the water is level to the "0" line.

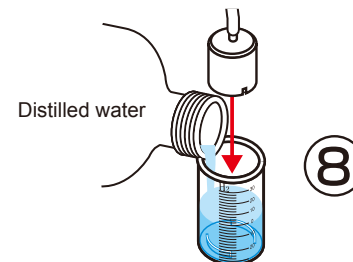

Procedure for repeated gas production (after step 14): Disconnect the small plugs from the tubes connected to the nozzles on the reversible fuel cell. This will allow water into the inner cylinders to replace the gasses and reset water levels to "0" line. Re-insert the plugs into the tubes and repeat electrolysis again.

- 9.** Connect the pre-cut tubes firmly onto the inner storage cylinders short nozzle, connect the tubes opposite end to the upper nozzles located on the upper positions of both "H2" and "O2" sides of fuel cell shown here. Make sure the tubes are connected correctly to the corresponding sides of the fuel cell.

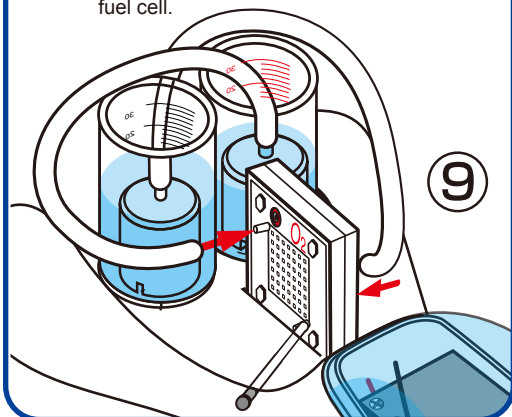

- 13.** For solar panel: remove the cables connecting the solar panel to the fuel cell. Turn the switch on the battery box to "off" and remove the cables from the cable sockets located on the fuel cell. Keep the battery box switched to the "off" position except during the time you are performing electrolysis.

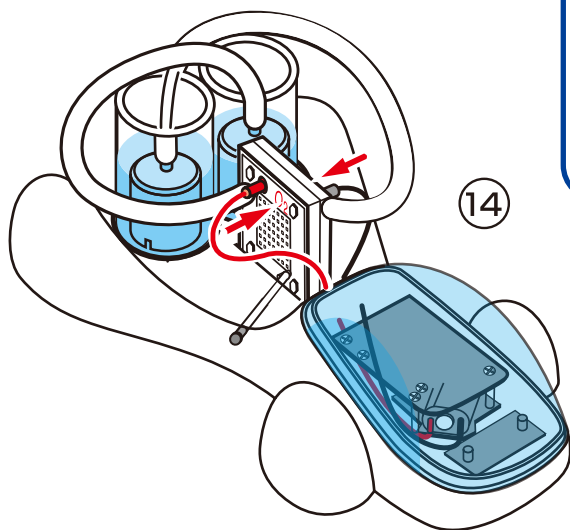

- 10.** Connect the red and black cables to the solar panel, and connect the other ends to the red and black sockets on the fuel cell.

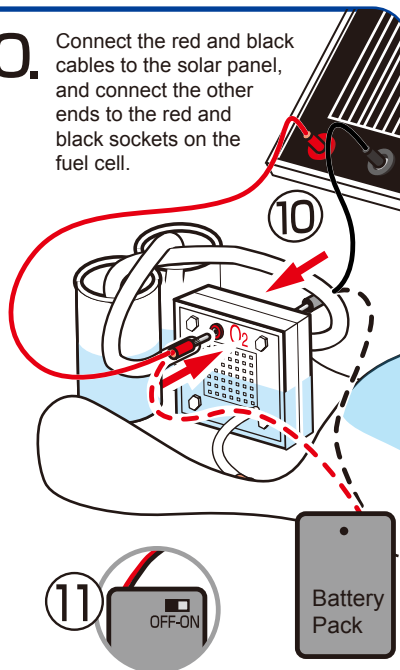

- 11. ALTERNATE OPTION:** Connect the red cable from the battery pack to the red socket on the fuel cell and connect the black cable to black socket.

Switch the battery pack to the "on" position.

- 12.** Electrolysis of water should begin with oxygen and hydrogen being produced and stored in each storage tank. Wait until the bubbles in the hydrogen tank start to escape from the inner storage cylinder located in the H2 cylinder. (Be patient, process can take 15–20min)

- 14.** Remove the red and black cables connected to the fuel cell in "step 10". Insert the banana plug cables from the car's motor into the red and black plugs on the fuel cell. Make sure the colors of the plugs and cables are inserted into plug socket of the same color as in "step 10". The motor should begin to power the car and cause it to start in motion. The estimated driving time on one charge is about 3 to 5 minutes.

HYDROCAR TECHNICAL SUPPORT

1. The water levels do not drop when the gas outlet tubes on both sides of the fuel cell are unplugged.

Solution:

Check whether the holes on the wall of the inner cylinder are blocked. If so, turn the inner cylinder until water enters the holes and fills up the inner cylinder.

2. The reversible fuel cell does not produce hydrogen and/or oxygen.

Solution:

- Check whether the wires are appropriately connected, and whether there are any loose connections. The fuel cell could be completely destroyed if the red wire of the battery pack is connected to the black jack of the fuel cell.
- Check whether the switch of the battery pack is in the "on" position.

3. The water electrolysis process slows down.

Solution:

- Add water to the oxygen side of the fuel cell and wait for about 5 minutes.
- Replace old AA batteries with new AA batteries inside the battery pack.

4. The car stops moving while there is still hydrogen left inside the tanks.

Solution:

- Purge the gases and perform water electrolysis for 4-5 minutes. Unplug the hydrogen gas outlet tube and oxygen gas tubes to purge the gases. Perform water electrolysis again until the hydrogen tank is filled, and connect the motor to the fuel cell. If the problem persists, go to the next step.
- Let the water electrolysis process last about 10 minutes to consume the residual water. To push water out of the fuel cell, purge the gases. Perform water electrolysis once more until the hydrogen tank is filled, then connect the motor to the fuel cell.

Note: Hydrogen fuel cells are consumables and have a life time of up to 2 years and we give warranty for 1 year. You can buy replacement fuel cells from Horizon by placing online orders at www.fuelcellstore.com