

TEN 6WIN Series

6W, Ultra-Wide Input Range DIP, Single & Dual Output DC/DC Converters

Features

- ▶ DIP-24 Plastic Package
- ▶ Ultra-wide 4:1 Input Range
- ▶ High Efficiency up to 84%
- ▶ Operating Temp. Range -40°C to +85°C
- ▶ Overload Protection
- ▶ I/O-isolation 1500VDC (opt. 3000VDC)
- ▶ Input Filter meets EN 55022, class A and FCC, level A
- ▶ 3 Years Product Warranty

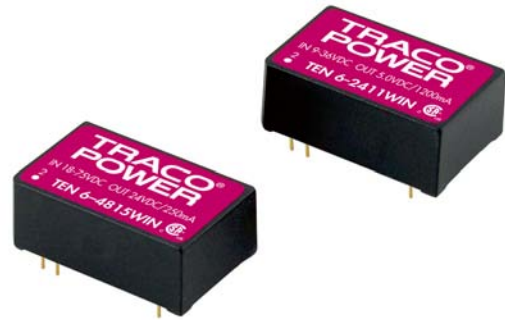

Applications

- ▶ Distributed power architectures
- ▶ Workstations
- ▶ Computer equipment
- ▶ Communications equipment

General Description

The TRACO TEN 6WIN series is a new range of high performance dc-dc converter modules with 6W output power, featuring ultra-wide 4:1 input voltage ranges and tight output voltage regulation. The product comes in a DIP-24 package with industry standard footprint.

Excellent efficiency allows an operation temperature range of -40°C to +85°C . Standard features include overload protection. Typical applications for these cost optimized converters are battery powered equipment, instrumentation, datacom and industrial electronics.

Table of contents

Absolute Maximum Rating.....	P2	Short Circuitry Protection.....	P39
Output Specification.....	P2	Mechanical Data.....	P40
Input Specification.....	P3	Recommended Pad Layout Single & Dual	P40
General Specification.....	P4	Soldering and Reflow Consideration.....	P41
Characteristic Curves.....	P5	Packaging Information.....	P41
Testing Configurations.....	P37	Part Number Structure.....	P42
EMC Considerations.....	P38	Safety and Installation Instruction.....	P43
Input Source Impedance.....	P39	MTBF and Reliability.....	P43
Output Over Current Protection.....	P39		

Absolute Maximum Rating					
Parameter	Model	Min	Max	Unit	
Input Voltage Input Surge Voltage (1sec.)	TEN 6-24xxWIN	---	50	VDC	
	TEN 6-48xxWIN	---	100		
Operating Ambient Temperature Without Derating With Derating	All	-40	+70	°C	
		-40	+85		
Operating Case Temperature	All	---	+100	°C	
Storage Temperature	All	-50	+125	°C	

Output Specification					
Parameter	Model	Min	Nominal	Max	Unit
Output Voltage ($V_{in} = V_{in\ nom}$; Full Load; $T_A = 25^\circ\text{C}$)	TEN 6-xx10WIN	3.234	3.3	3.366	VDC
	TEN 6-xx11WIN	4.9	5	5.1	
	TEN 6-xx12WIN	11.76	12	12.24	
	TEN 6-xx13WIN	14.7	15	15.3	
	TEN 6-xx15WIN	23.52	24	24.48	
	TEN 6-xx21WIN	± 4.9	± 5	± 5.1	
	TEN 6-xx22WIN	± 11.76	± 12	± 12.24	
	TEN 6-xx23WIN	± 14.7	± 15	± 15.3	
Output Regulation Line ($V_{in\ min}$ to $V_{in\ max}$ at Full Load)			± 0.1	± 0.5	%
Output Regulation Load (0% to 100% of Full Load)			± 0.6	± 1.2	%
Output Ripple & Noise Peak-to-Peak (20MHz bandwidth)	All		50	80	mV _{P-P}
Temperature Coefficient	All	---	± 0.01	± 0.02	%/°C
Output Voltage Overshoot ($V_{in\ min}$ to $V_{in\ max}$; Full Load; $T_A = 25^\circ\text{C}$)	All	---	---	5	%
Dynamic Load Response ($V_{in} = V_{in\ nom}$; $T_A = 25^\circ\text{C}$ Load step change form form 75% to 100% or 100% to 75% of full Load)	All				
				± 3	---
Recovery Time ($V_{out} < 10\%$ peak deviation)			300	600	μS
Output Current	TEN 6-xx10WIN	0	---	1200	mA
	TEN 6-xx11WIN	0	---	1200	
	TEN 6-xx12WIN	0	---	500	
	TEN 6-xx13WIN	0	---	400	
	TEN 6-xx15WIN	0	---	250	
	TEN 6-xx21WIN	0	---	± 500	
	TEN 6-xx22WIN	0	---	± 250	
	TEN 6-xx23WIN	0	---	± 200	
Output Over Current Protection	All	110	150	---	%FL
Output Short Circuit Protection	All	Continuous			

Input Specification					
Parameter	Model	Min	Nominal	Max	Unit
Operating Input Voltage	TEN 6-24xxWIN	9	24	36	VDC
	TEN 6-48xxWIN	18	48	75	
Under Voltage Lockout Turn-on Threshold	TEN 6-24xxWIN	7	8	9	VDC
	TEN 6-48xxWIN	14	16	18	
Under Voltage Lockout Turn-off Threshold	TEN 6-24xxWIN	---	---	8.5	VDC
	TEN 6-48xxWIN	---	---	16	
Input reflected ripple current (5 to 20MHz, 4.7μH source impedance)	TEN 6-24xxWIN	---	20	---	mA _{P-P}
	TEN 6-48xxWIN	---	15	---	
Input Current ($V_{in} = V_{in\ nom}$; Full Load)	TEN 6-2410WIN	---	214	---	mA
	TEN 6-2411WIN	---	313	---	
	TEN 6-2412WIN	---	298	---	
	TEN 6-2413WIN	---	298	---	
	TEN 6-2415WIN	---	298	---	
	TEN 6-2421WIN	---	260	---	
	TEN 6-2422WIN	---	298	---	
	TEN 6-2423WIN	---	298	---	
	TEN 6-4810WIN	---	107	---	
	TEN 6-4811WIN	---	156	---	
	TEN 6-4812WIN	---	149	---	
	TEN 6-4813WIN	---	149	---	
	TEN 6-24815WIN	---	149	---	
	TEN 6-4821WIN	---	130	---	
	TEN 6-4822WIN	---	149	---	
	TEN 6-4823WIN	---	149	---	
Input current (Typical value at $V_{in} = V_{in\ nom}$; No Load)	TEN 6-2410WIN	---	20	---	mA
	TEN 6-2411WIN				
	TEN 6-2412WIN				
	TEN 6-2413WIN				
	TEN 6-2415WIN				
	TEN 6-2421WIN				
	TEN 6-2422WIN				
	TEN 6-2423WIN				
	TEN 6-4810WIN	---	10	---	
	TEN 6-4811WIN				
	TEN 6-4812WIN				
	TEN 6-4813WIN				
	TEN 6-4815WIN				
	TEN 6-4821WIN				
	TEN 6-4822WIN				
	TEN 6-4823WIN				

General Specification					
Parameter	Model	Min	Nominal	Max	Unit
Efficiency ($V_{in} = V_{in\ nom}$; Full Load; $T_A = 25^\circ\text{C}$)	TEN 6-2410WIN	---	77	---	%
	TEN 6-2411WIN	---	80	---	
	TEN 6-2412WIN	---	84	---	
	TEN 6-2413WIN	---	84	---	
	TEN 6-2415WIN	---	84	---	
	TEN 6-2421WIN	---	80	---	
	TEN 6-2422WIN	---	84	---	
	TEN 6-2423WIN	---	84	---	
	TEN 6-4810WIN	---	77	---	
	TEN 6-4811WIN	---	80	---	
	TEN 6-4812WIN	---	84	---	
	TEN 6-4813WIN	---	84	---	
	TEN 6-4815WIN	---	84	---	
	TEN 6-4821WIN	---	80	---	
	TEN 6-4822WIN	---	84	---	
TEN 6-4823WIN	---	84	---		
Isolation voltage Input to Output (for 60 seconds)	Standard	1500	---	---	VDC
	Suffix -HI (Note)	3000	---	---	VDC
Isolation resistance	All	1000	---	---	MΩ
Isolation capacitance		---	1000	---	pF
Switching Frequency		---	330	---	KHz
MTBF MIL-STD-217F, $T_A = +25^\circ\text{C}$, Ground Benign		800	---	---	K Hours

Note:

To order the converter at 3KVDC isolation, please add a **suffix -HI** (e.g. TEN 6-2412WIN-HI) to order code.

Characteristic Curves

All test conditions are at 25°C The figures are identical for TEN 6-2410WIN

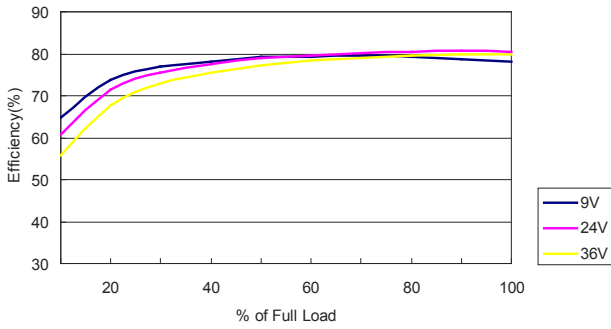

Efficiency Versus Output Current

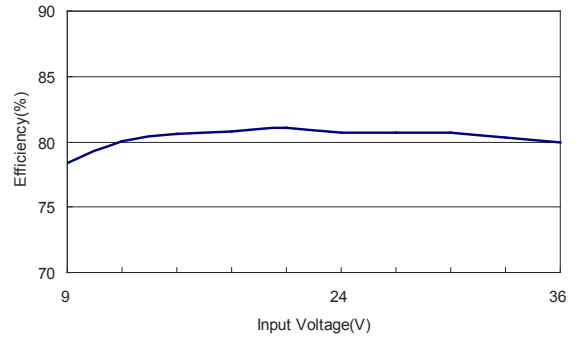

Efficiency Versus Input Voltage. Full Load

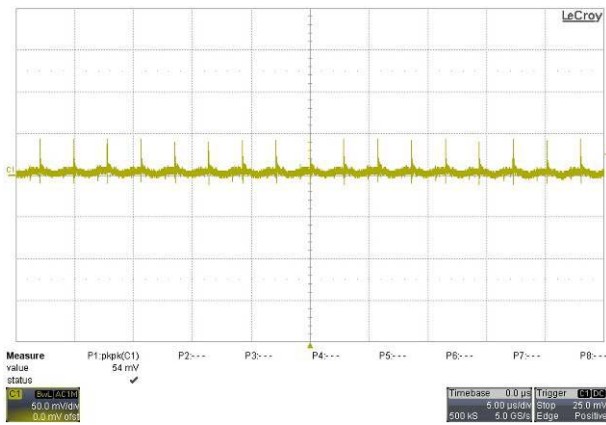

Typical Output Ripple and Noise.
 $V_{in} = V_{in\ nom}$; Full Load; T_A

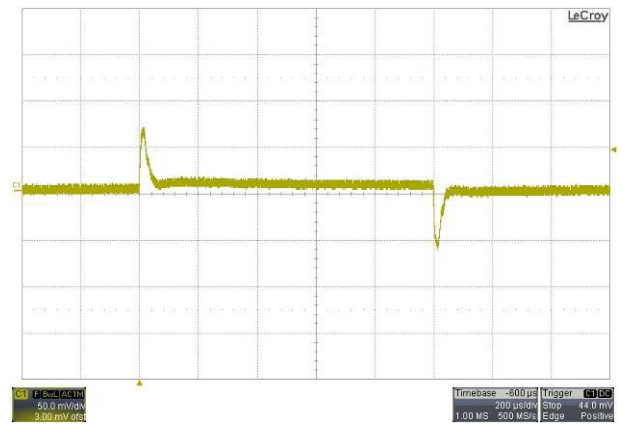

Transient Response to Dynamic Load Change from 100% to 75% of Full Load ; $V_{in} = V_{in\ nom}$

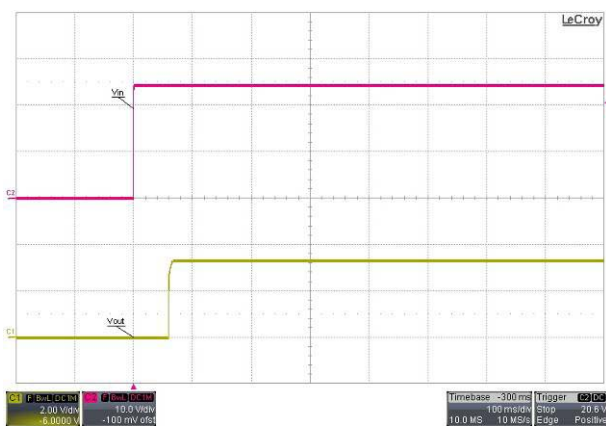

Typical Input Start-Up and Output Rise Characteristic
 $V_{in} = V_{in\ nom}$; Full Load

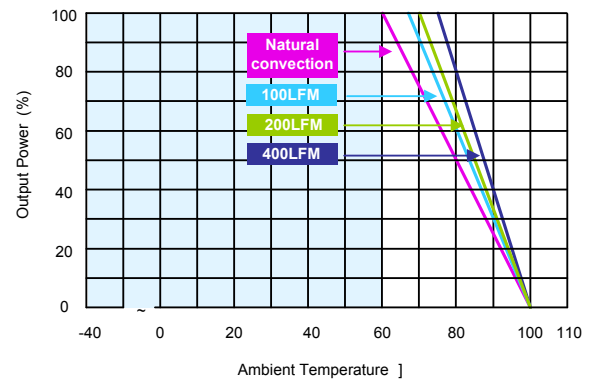

Derating Output Current Versus Ambient Temperature and Airflow
 $V_{in} = V_{in\ nom}$

Characteristic Curves

All test conditions are at 25°C The figures are identical for TEN 6-2410WIN (Continued)

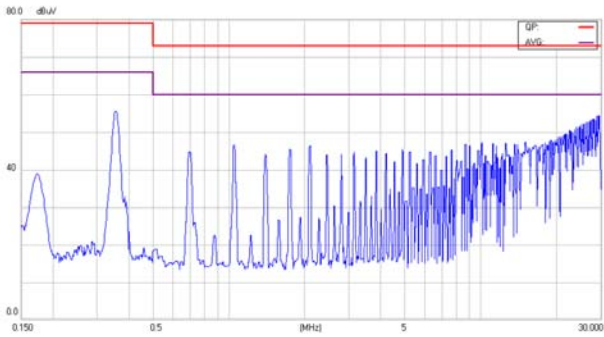

Conduction Emission of EN55022 Class A

$V_{in} = V_{in\ nom}$; Full Load

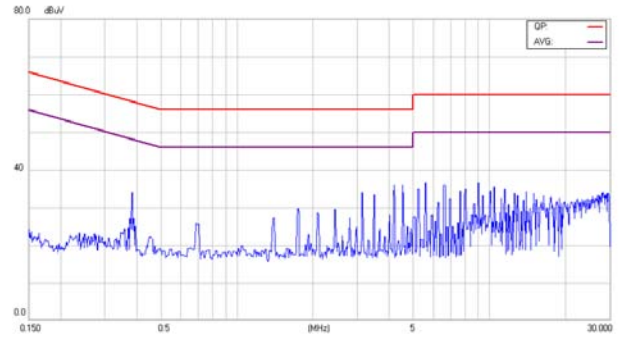

Conduction Emission of EN55022 Class B

$V_{in} = V_{in\ nom}$; Full Load

Characteristic Curves

All test conditions are at 25°C The figures are identical for TEN 6-2411WIN

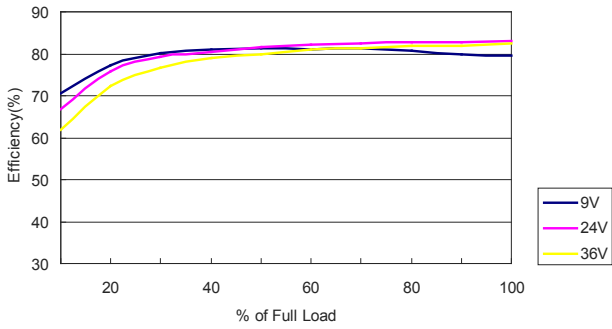

Efficiency Versus Output Current

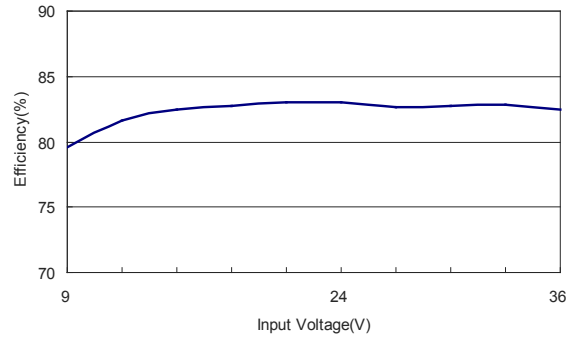

Efficiency Versus Input Voltage. Full Load

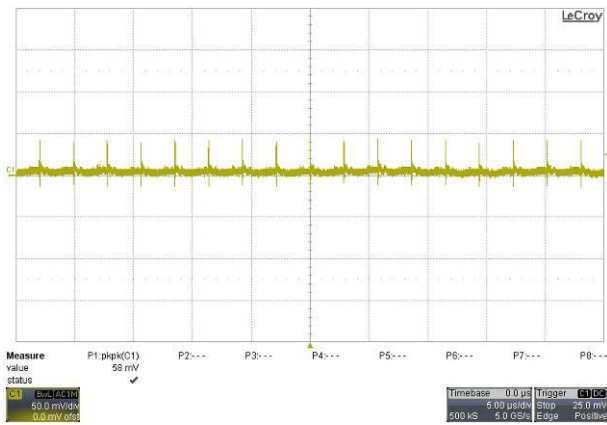

Typical Output Ripple and Noise.
 $V_{in} = V_{in\ nom}$; Full Load; T_A

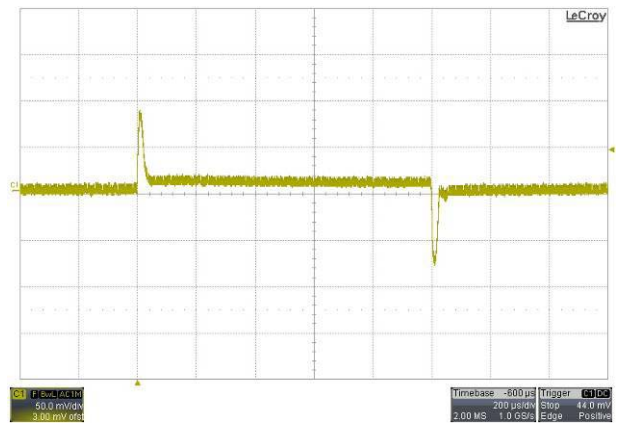

Transient Response to Dynamic Load Change from 100% to 75% of Full Load ; $V_{in} = V_{in\ nom}$

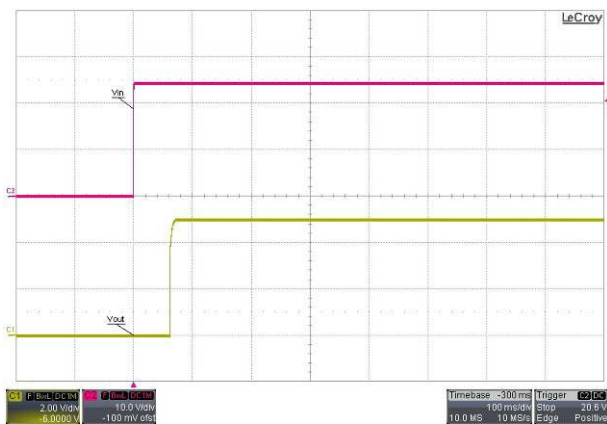

Typical Input Start-Up and Output Rise Characteristic
 $V_{in} = V_{in\ nom}$; Full Load

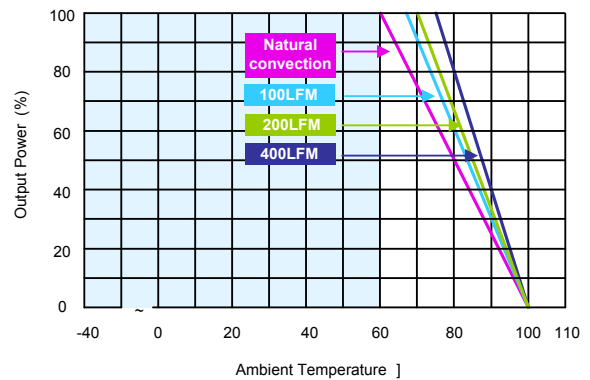

Derating Output Current Versus Ambient Temperature and Airflow
 $V_{in} = V_{in\ nom}$

Characteristic Curves

All test conditions are at 25°C The figures are identical for TEN 6-2411WIN (Continued)

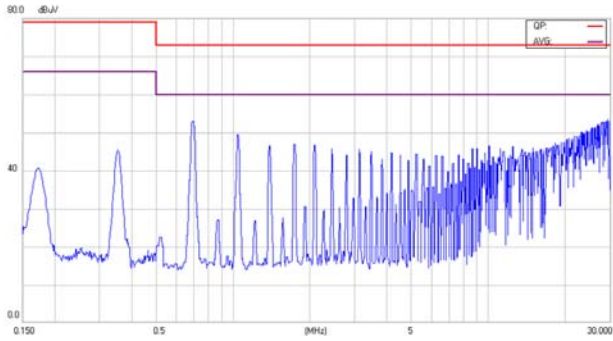

Conduction Emission of EN55022 Class A

$V_{in} = V_{in\ nom}$; Full Load

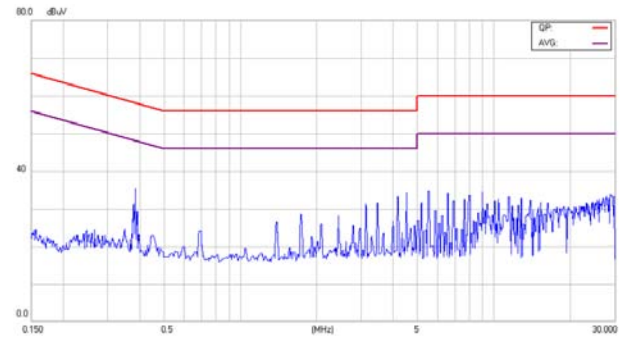

Conduction Emission of EN55022 Class B

$V_{in} = V_{in\ nom}$; Full Load

Characteristic Curves

All test conditions are at 25°C The figures are identical for TEN 6-2412WIN

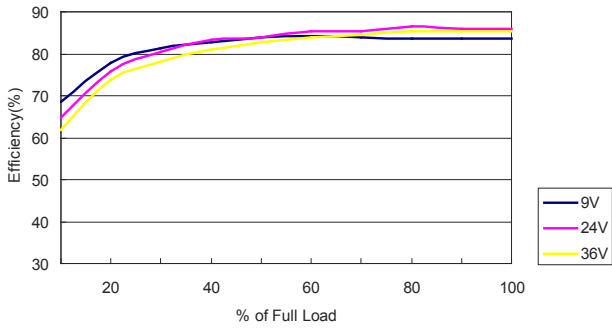

Efficiency Versus Output Current

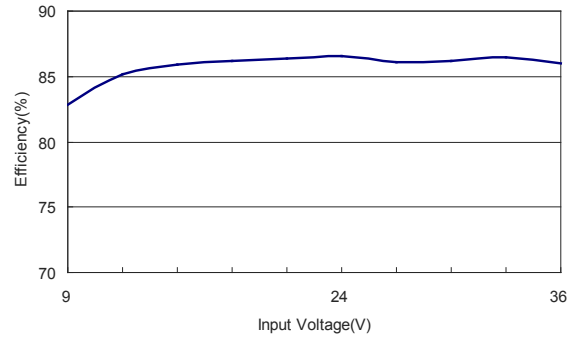

Efficiency Versus Input Voltage. Full Load

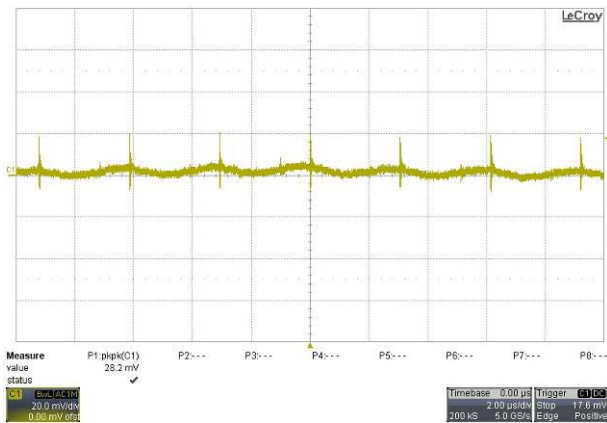

Typical Output Ripple and Noise.
 $V_{in} = V_{in\ nom}$; Full Load; T_A

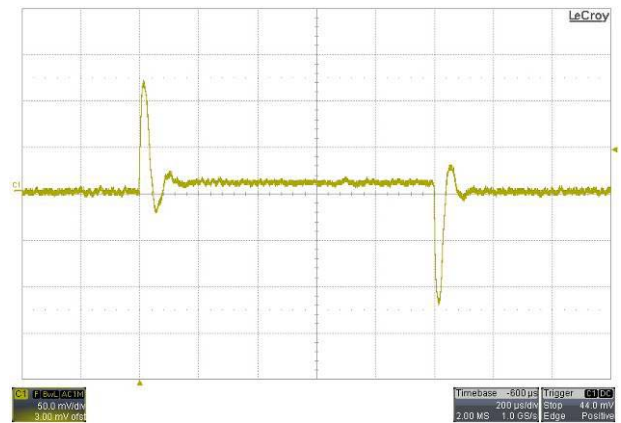

Transient Response to Dynamic Load Change from 100% to 75% of Full Load ; $V_{in} = V_{in\ nom}$

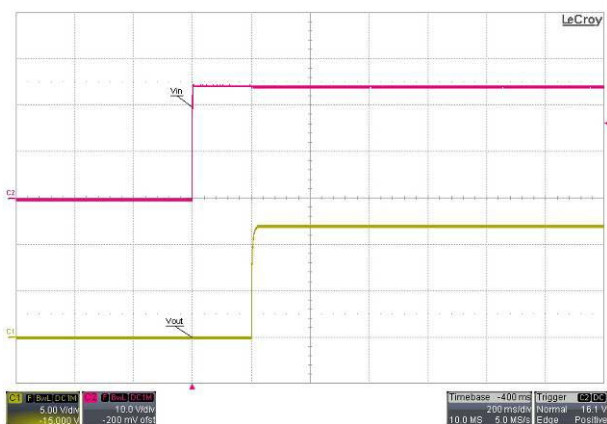

Typical Input Start-Up and Output Rise Characteristic
 $V_{in} = V_{in\ nom}$; Full Load

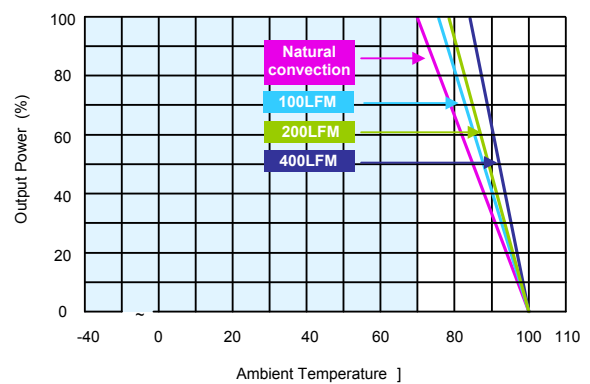

Derating Output Current Versus Ambient Temperature and Airflow
 $V_{in} = V_{in\ nom}$

Characteristic Curves

All test conditions are at 25°C The figures are identical for TEN 6-2412WIN (Continued)

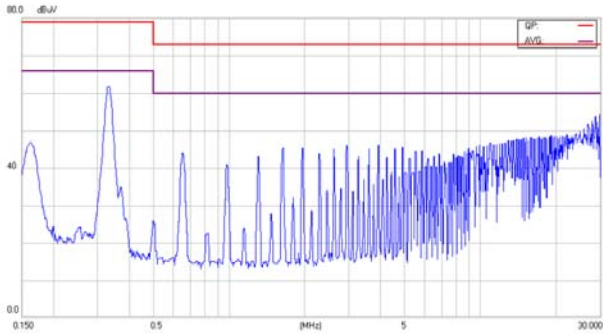

Conduction Emission of EN55022 Class A

$V_{in} = V_{in\ nom}$; Full Load

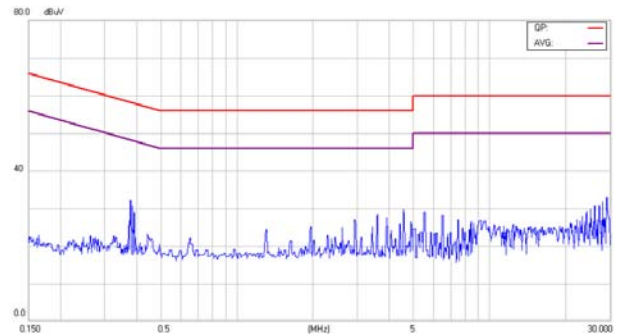

Conduction Emission of EN55022 Class B

$V_{in} = V_{in\ nom}$; Full Load

Characteristic Curves

All test conditions are at 25°C The figures are identical for TEN 6-2413WIN

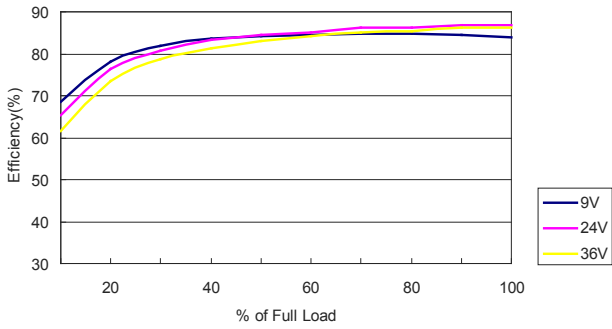

Efficiency Versus Output Current

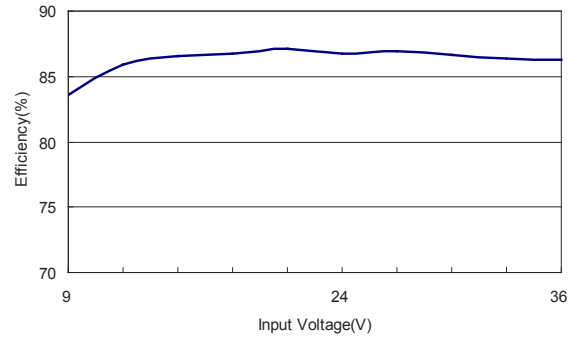

Efficiency Versus Input Voltage. Full Load

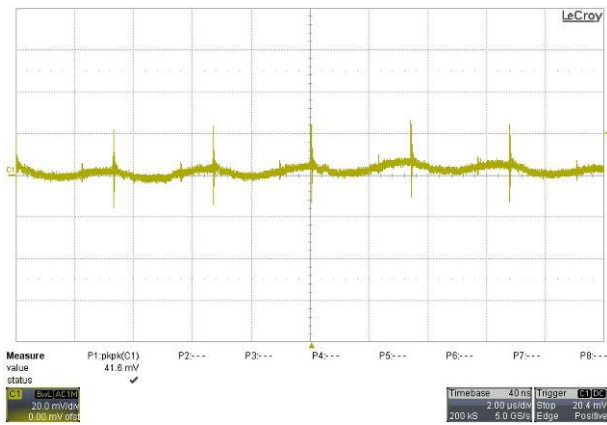

Typical Output Ripple and Noise.
 $V_{in} = V_{in nom}$; Full Load; T_A

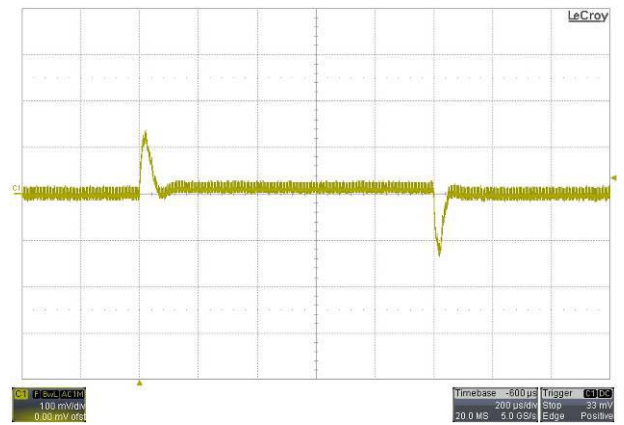

Transient Response to Dynamic Load Change from 100% to 75% of Full Load ; $V_{in} = V_{in nom}$

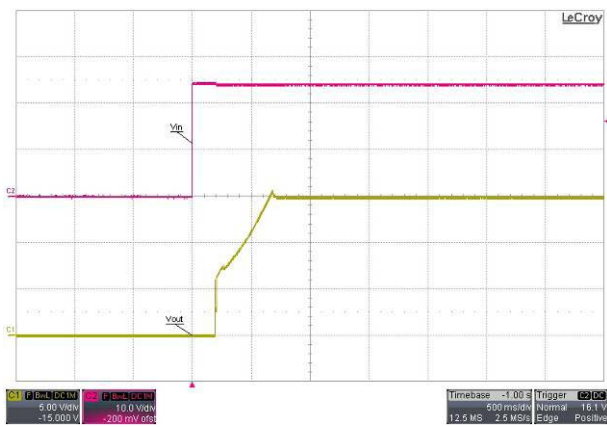

Typical Input Start-Up and Output Rise Characteristic
 $V_{in} = V_{in nom}$; Full Load

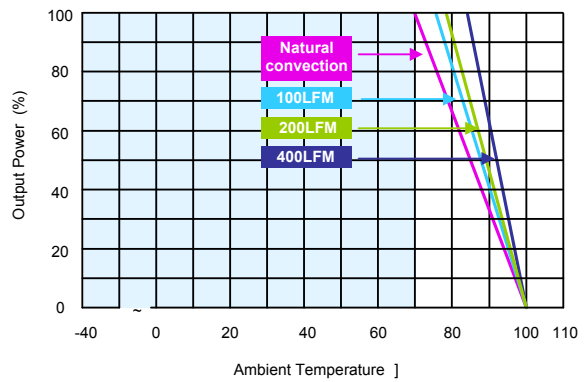

Derating Output Current Versus Ambient Temperature and Airflow
 $V_{in} = V_{in nom}$

Characteristic Curves

All test conditions are at 25°C The figures are identical for TEN 6-2413WIN (Continued)

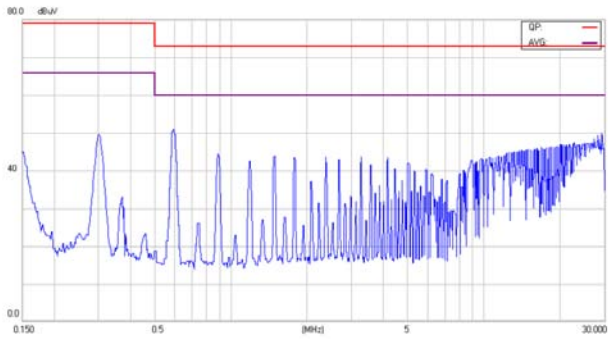

Conduction Emission of EN55022 Class A
 $V_{in} = V_{in\ nom}$; Full Load

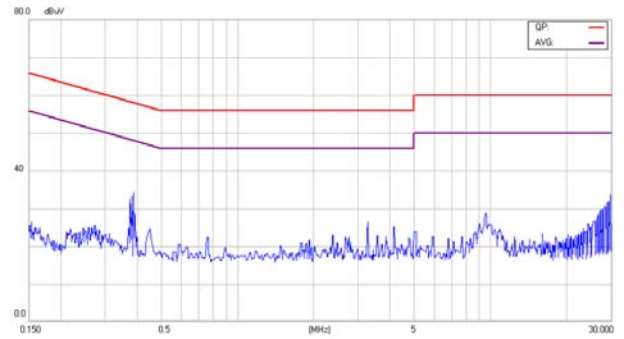

Conduction Emission of EN55022 Class B
 $V_{in} = V_{in\ nom}$; Full Load

Characteristic Curves

All test conditions are at 25°C The figures are identical for TEN 6-2415WIN

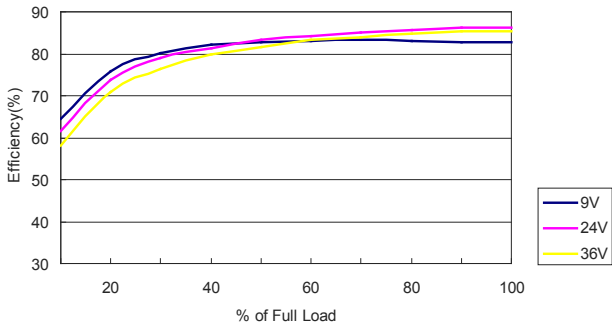

Efficiency Versus Output Current

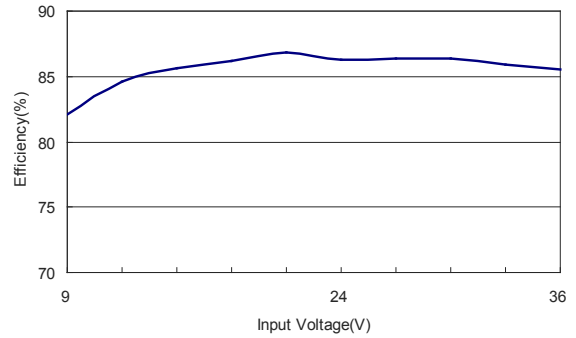

Efficiency Versus Input Voltage. Full Load

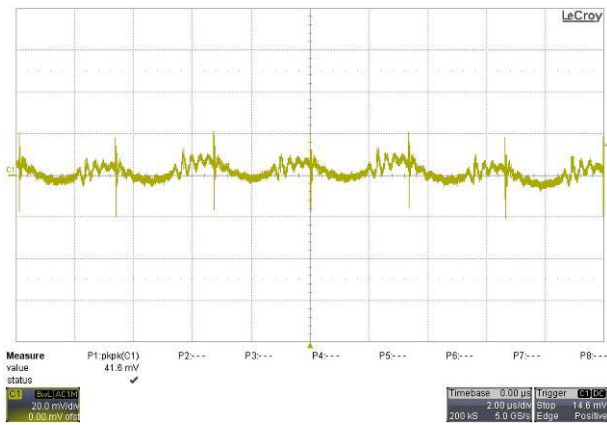

Typical Output Ripple and Noise.
 $V_{in} = V_{in\ nom}$; Full Load; T_A

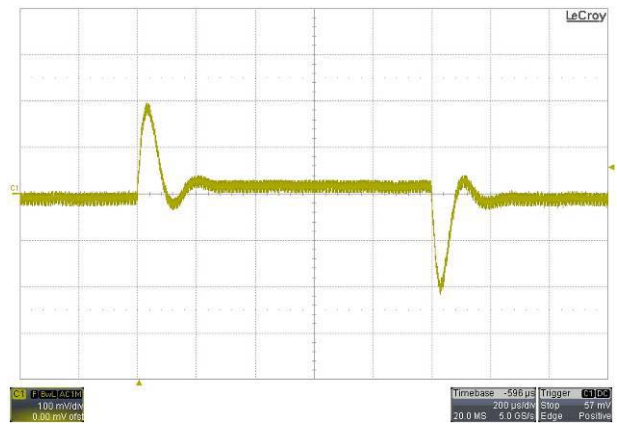

Transient Response to Dynamic Load Change from 100% to 75% of Full Load; $V_{in} = V_{in\ nom}$

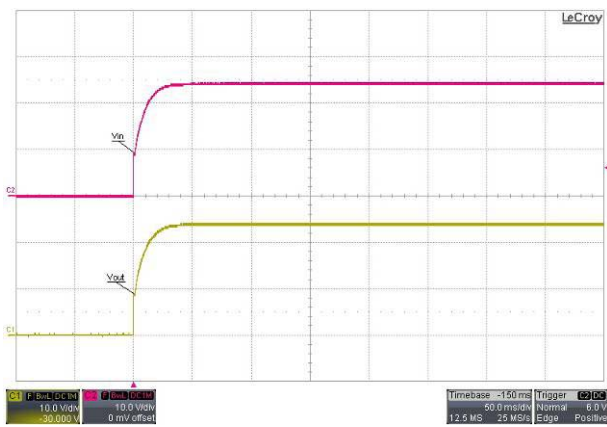

Typical Input Start-Up and Output Rise Characteristic
 $V_{in} = V_{in\ nom}$; Full Load

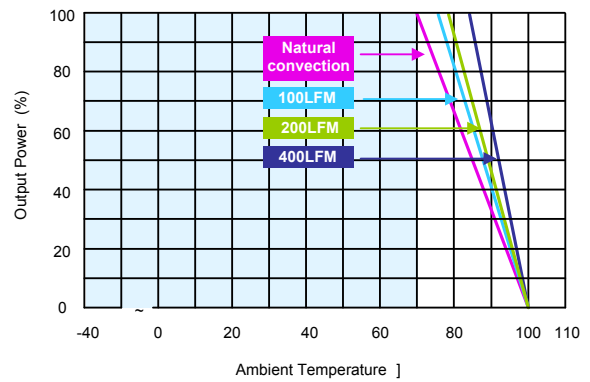

Derating Output Current Versus Ambient Temperature and Airflow
 $V_{in} = V_{in\ nom}$

Characteristic Curves

All test conditions are at 25°C The figures are identical for TEN 6-2415WIN (Continued)

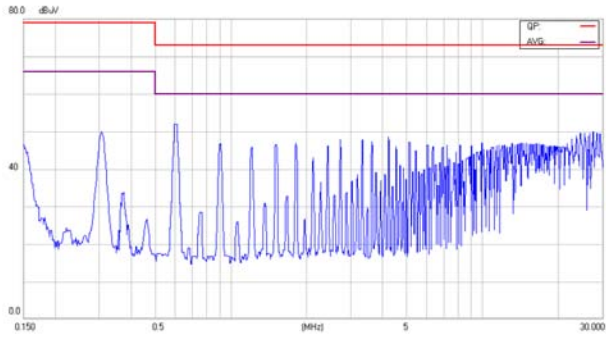

Conduction Emission of EN55022 Class A

$V_{in} = V_{in\ nom}$; Full Load

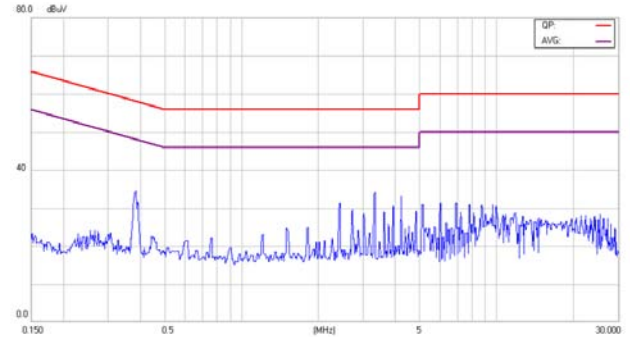

Conduction Emission of EN55022 Class B

$V_{in} = V_{in\ nom}$; Full Load

Characteristic Curves

All test conditions are at 25°C The figures are identical for TEN 6-2421WIN

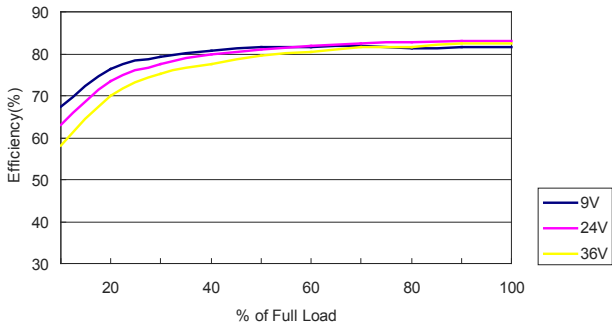

Efficiency Versus Output Current

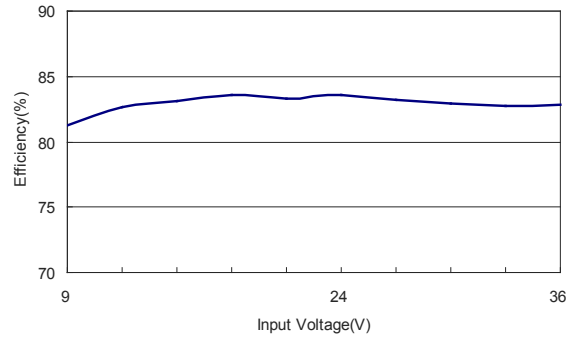

Efficiency Versus Input Voltage. Full Load

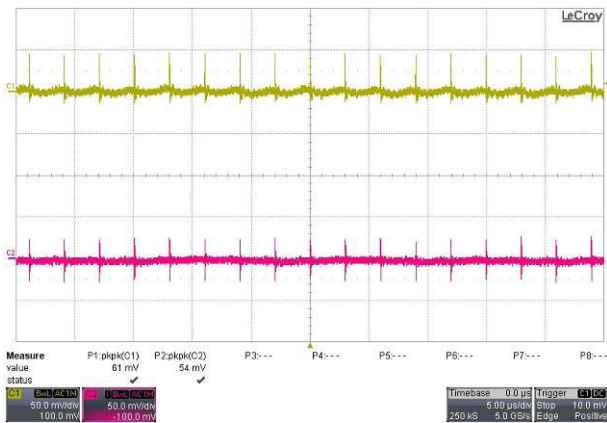

Typical Output Ripple and Noise.
 $V_{in} = V_{in nom}$; Full Load; T_A

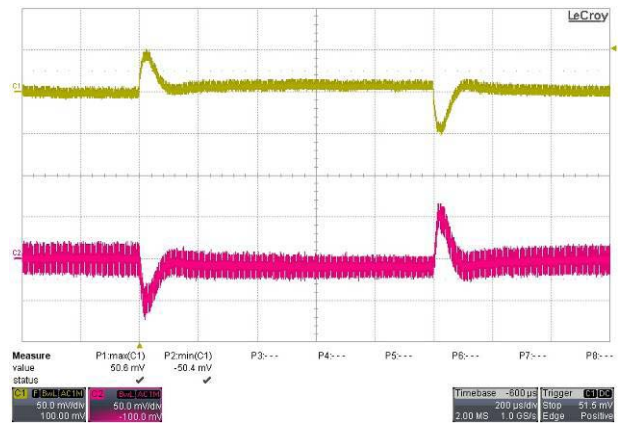

Transient Response to Dynamic Load Change from 100% to 75% of Full Load ; $V_{in} = V_{in nom}$

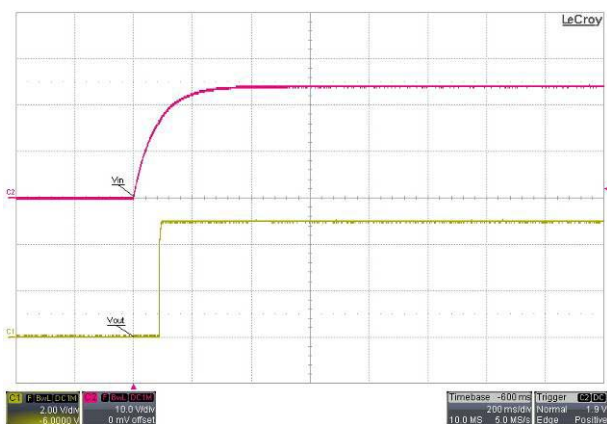

Typical Input Start-Up and Output Rise Characteristic
 $V_{in} = V_{in nom}$; Full Load

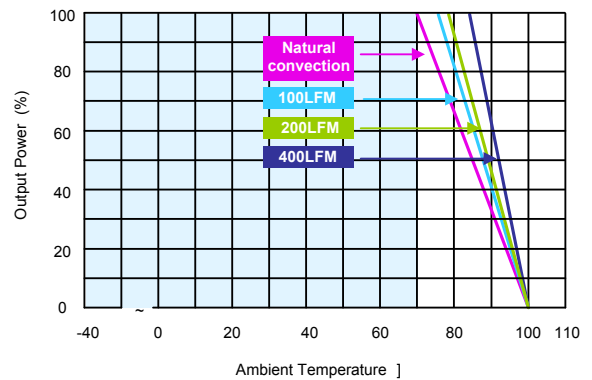

Derating Output Current Versus Ambient Temperature and Airflow
 $V_{in} = V_{in nom}$

Characteristic Curves

All test conditions are at 25°C The figures are identical for TEN 6-2421WIN (Continued)

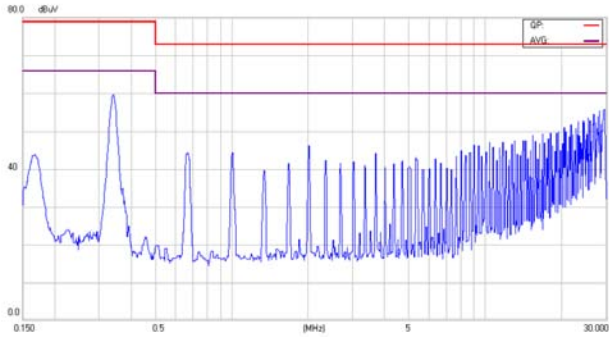

Conduction Emission of EN55022 Class A

$V_{in} = V_{in\ nom}$; Full Load

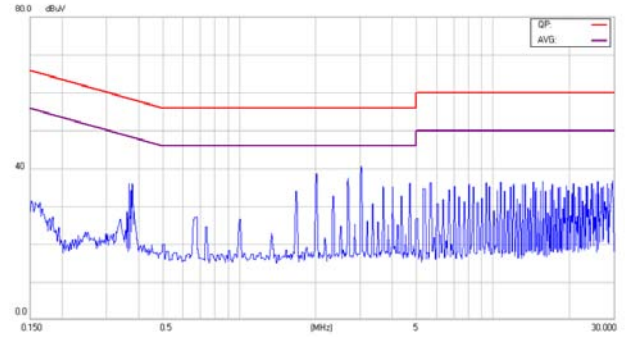

Conduction Emission of EN55022 Class B

$V_{in} = V_{in\ nom}$; Full Load

Characteristic Curves

All test conditions are at 25°C The figures are identical for TEN 6-2422WIN

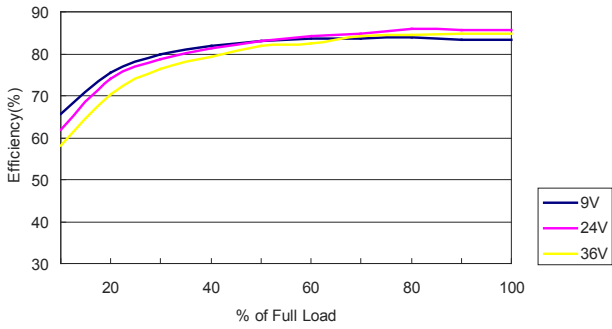

Efficiency Versus Output Current

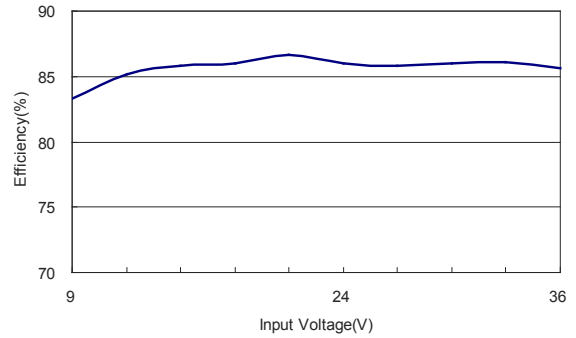

Efficiency Versus Input Voltage. Full Load

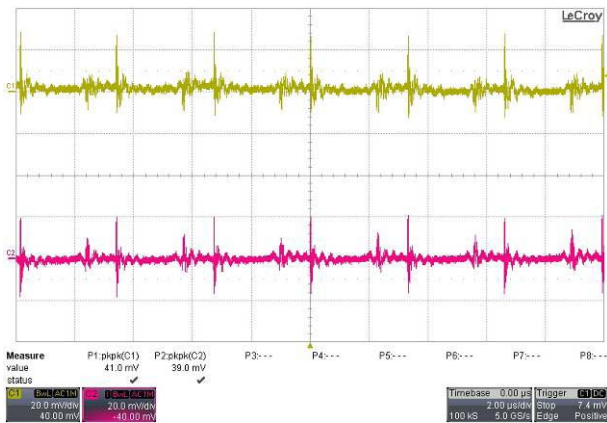

Typical Output Ripple and Noise.
 $V_{in} = V_{in,nom}$; Full Load; T_A

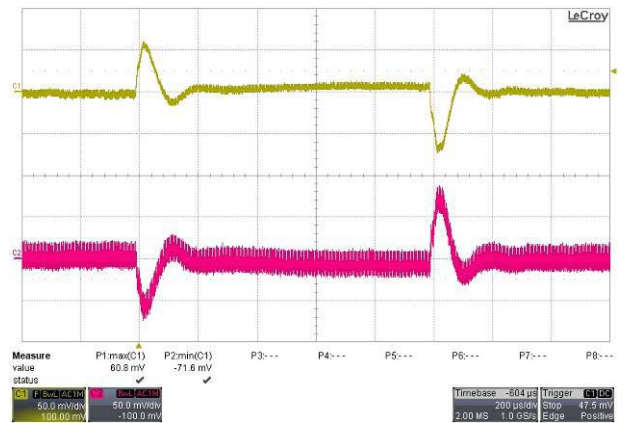

Transient Response to Dynamic Load Change from 100% to 75% of Full Load ; $V_{in} = V_{in,nom}$

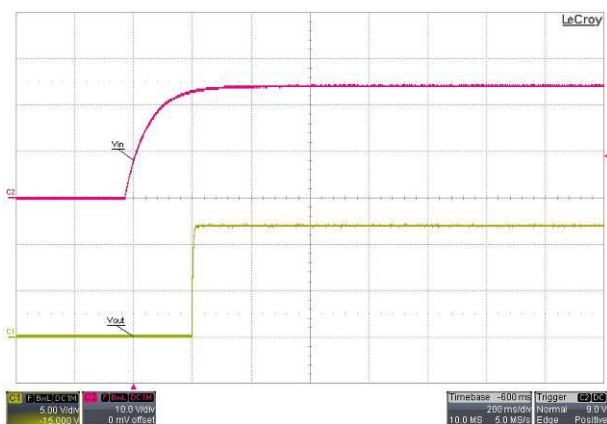

Typical Input Start-Up and Output Rise Characteristic
 $V_{in} = V_{in,nom}$; Full Load

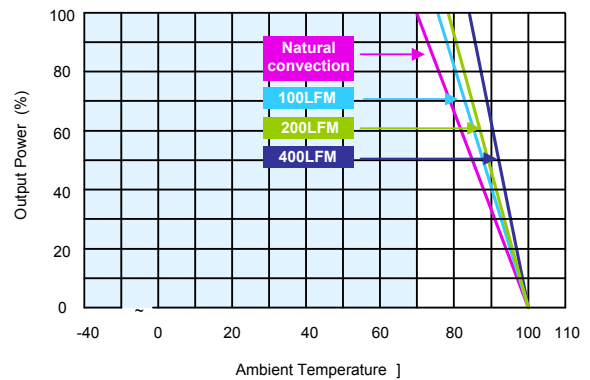

Derating Output Current Versus Ambient Temperature and Airflow
 $V_{in} = V_{in,nom}$

Characteristic Curves

All test conditions are at 25°C The figures are identical for TEN 6-2422WIN (Continued)

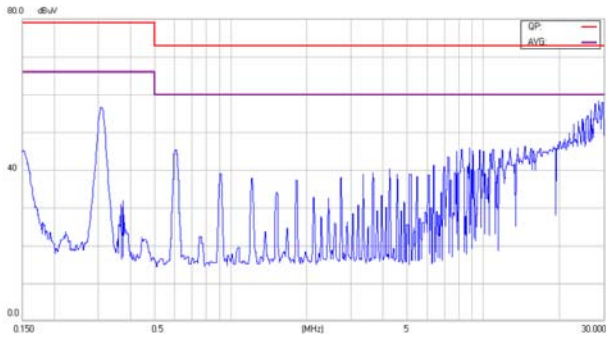

Conduction Emission of EN55022 Class A

$V_{in} = V_{in\ nom}$; Full Load

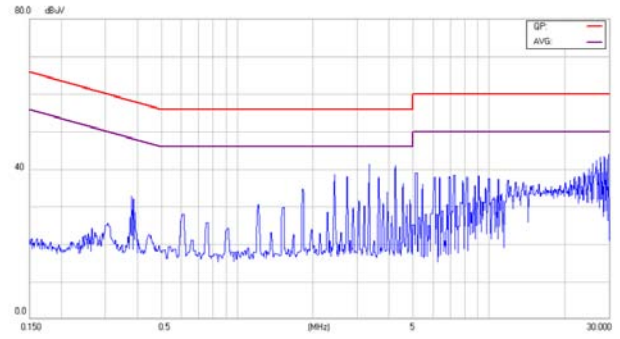

Conduction Emission of EN55022 Class B

$V_{in} = V_{in\ nom}$; Full Load

Characteristic Curves

All test conditions are at 25°C The figures are identical for TEN 6-2423WIN

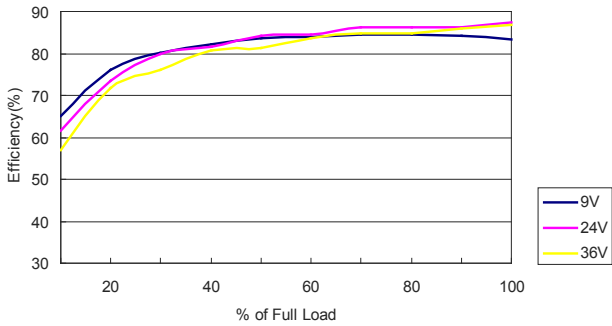

Efficiency Versus Output Current

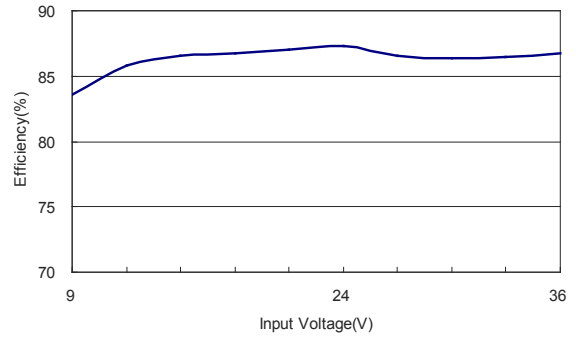

Efficiency Versus Input Voltage. Full Load

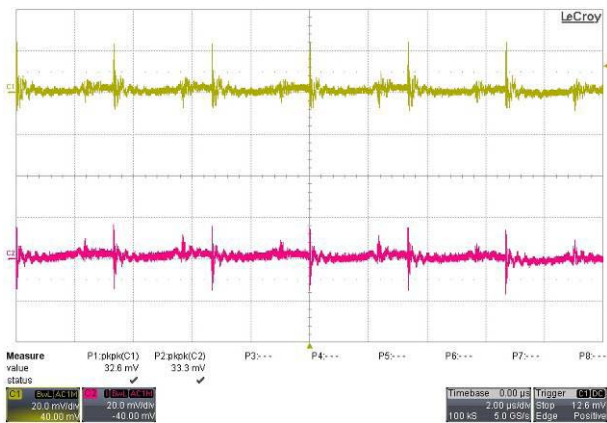

Typical Output Ripple and Noise.
 $V_{in} = V_{in nom}$; Full Load; T_A

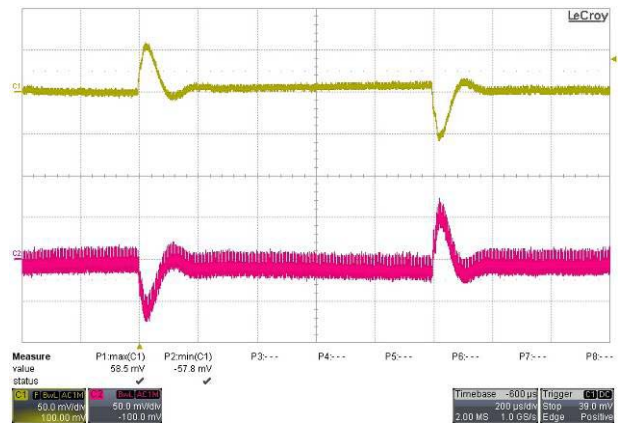

Transient Response to Dynamic Load Change from 100% to 75% of Full Load ; $V_{in} = V_{in nom}$

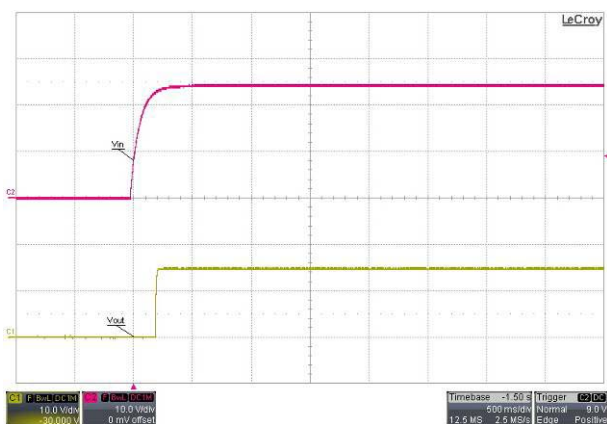

Typical Input Start-Up and Output Rise Characteristic
 $V_{in} = V_{in nom}$; Full Load

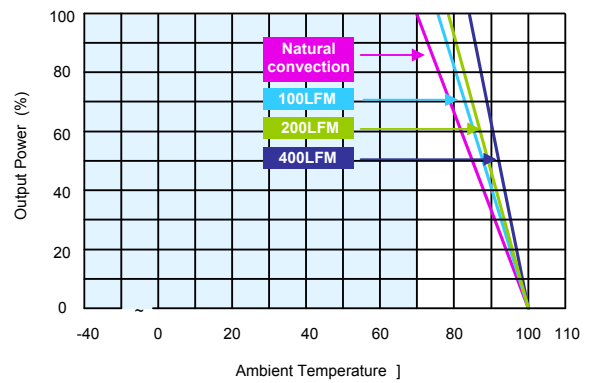

Derating Output Current Versus Ambient Temperature and Airflow
 $V_{in} = V_{in nom}$

Characteristic Curves

All test conditions are at 25°C The figures are identical for TEN 6-2423WIN (Continued)

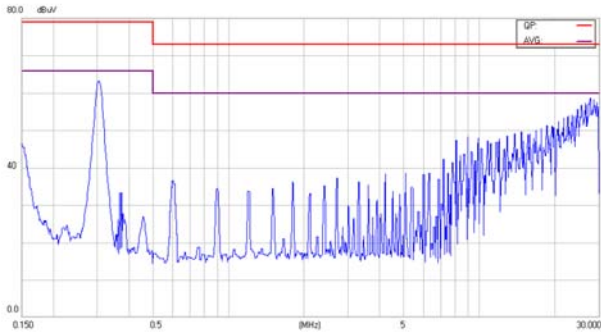

Conduction Emission of EN55022 Class A

$V_{in} = V_{in\ nom}$; Full Load

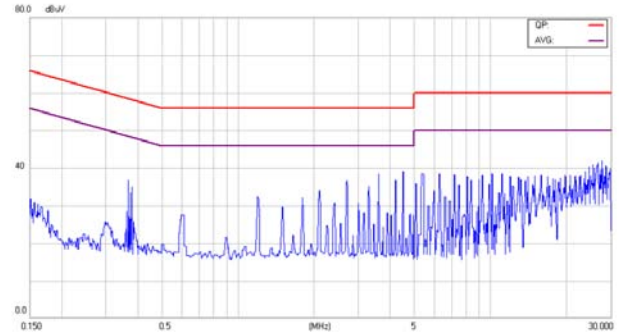

Conduction Emission of EN55022 Class B

$V_{in} = V_{in\ nom}$; Full Load

Characteristic Curves

All test conditions are at 25°C The figures are identical for TEN 6-4810WIN

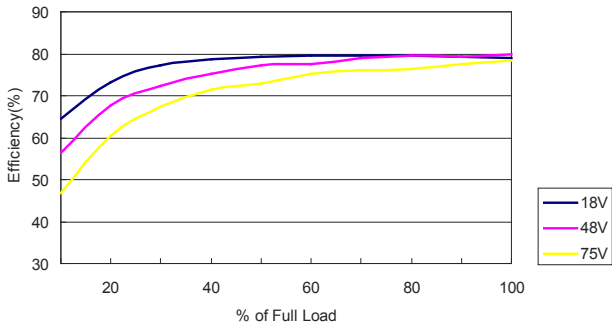

Efficiency Versus Output Current

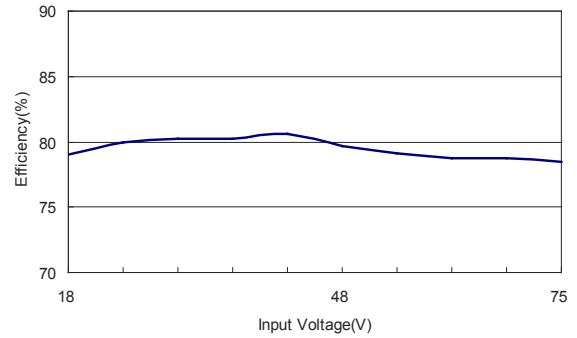

Efficiency Versus Input Voltage. Full Load

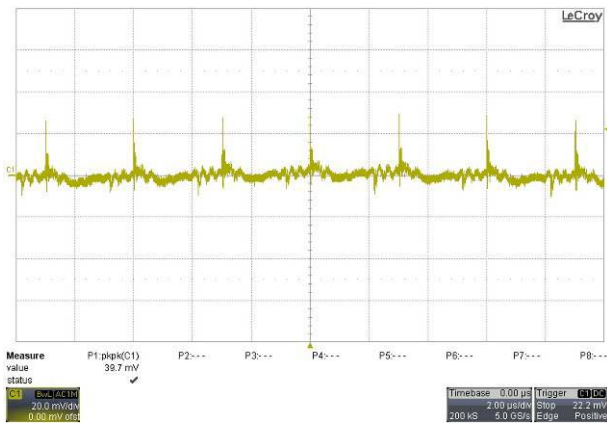

Typical Output Ripple and Noise.
 $V_{in} = V_{in\ nom}$; Full Load; T_A

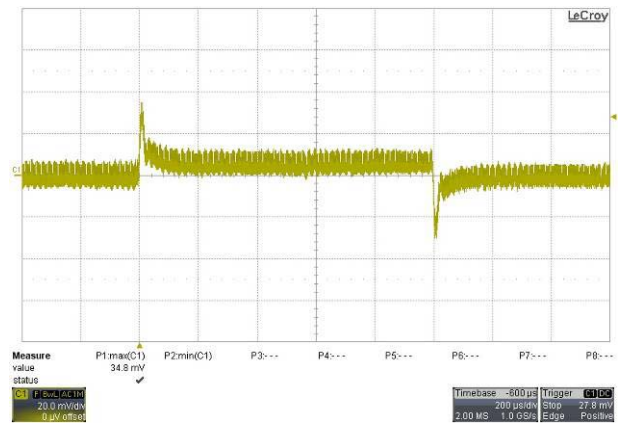

Transient Response to Dynamic Load Change from 100% to 75% of Full Load; $V_{in} = V_{in\ nom}$

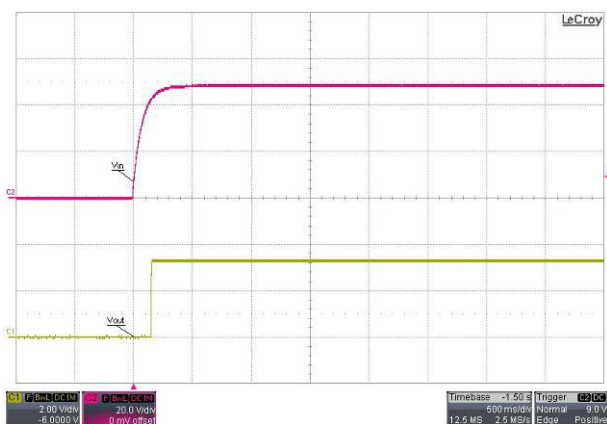

Typical Input Start-Up and Output Rise Characteristic
 $V_{in} = V_{in\ nom}$; Full Load

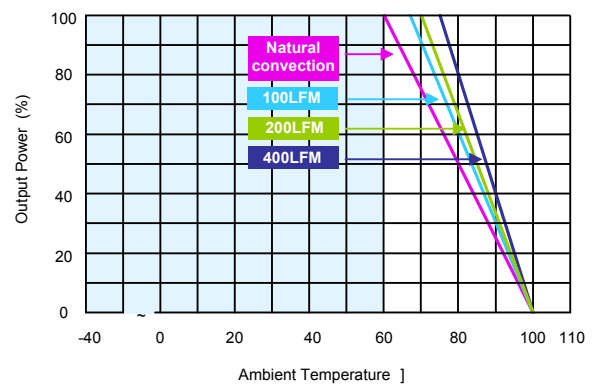

Derating Output Current Versus Ambient Temperature and Airflow
 $V_{in} = V_{in\ nom}$

Characteristic Curves

All test conditions are at 25°C The figures are identical for TEN 6-4810WIN (Continued)

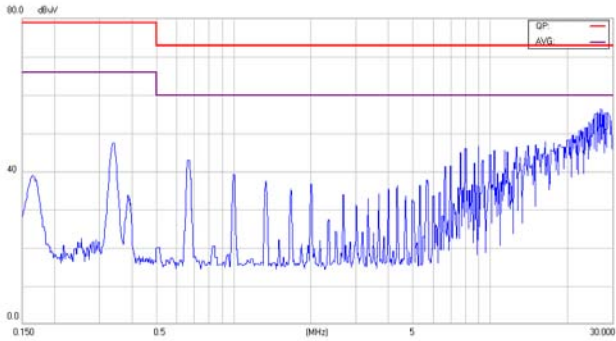

Conduction Emission of EN55022 Class A

$V_{in} = V_{in\ nom}$; Full Load

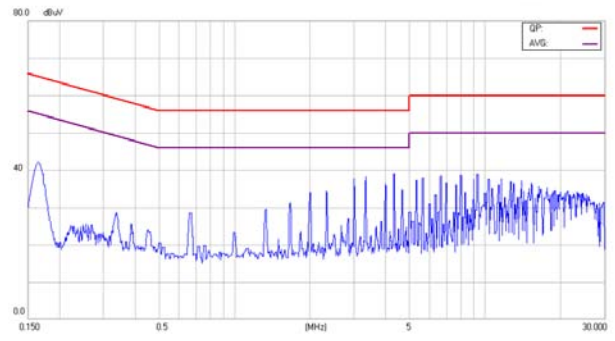

Conduction Emission of EN55022 Class B

$V_{in} = V_{in\ nom}$; Full Load

Characteristic Curves

All test conditions are at 25°C The figures are identical for TEN 6-4811WIN

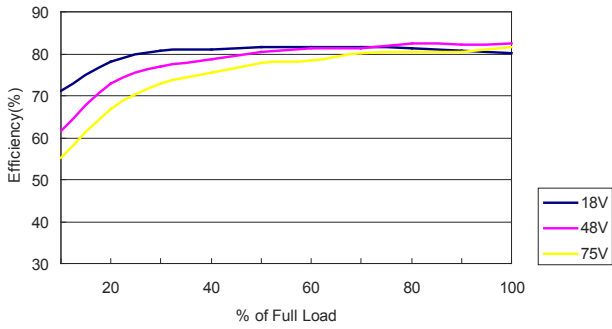

Efficiency Versus Output Current

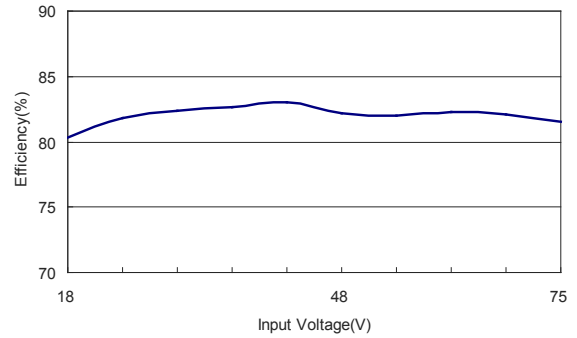

Efficiency Versus Input Voltage. Full Load

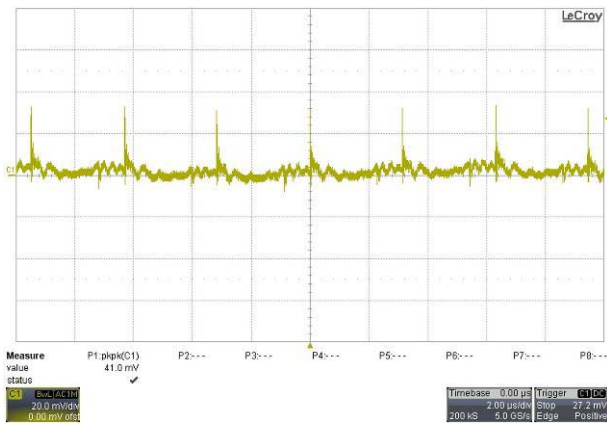

Typical Output Ripple and Noise.
 $V_{in} = V_{in\ nom}$; Full Load; T_A

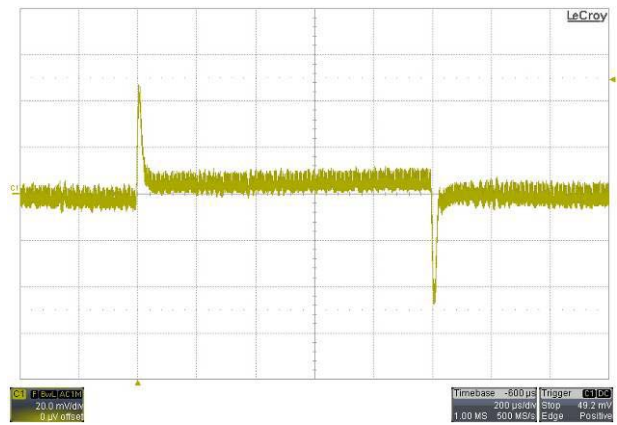

Transient Response to Dynamic Load Change from 100% to 75% of Full Load ; $V_{in} = V_{in\ nom}$

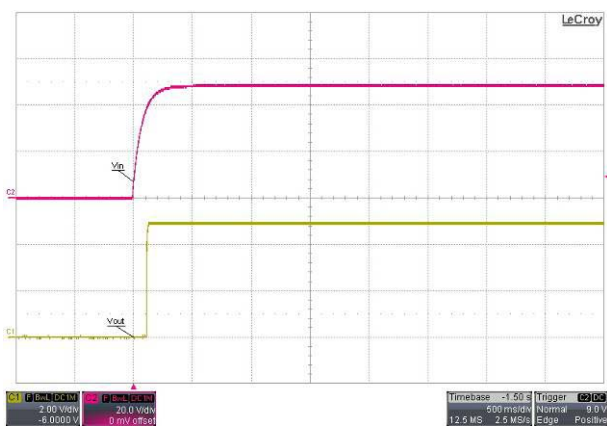

Typical Input Start-Up and Output Rise Characteristic
 $V_{in} = V_{in\ nom}$; Full Load

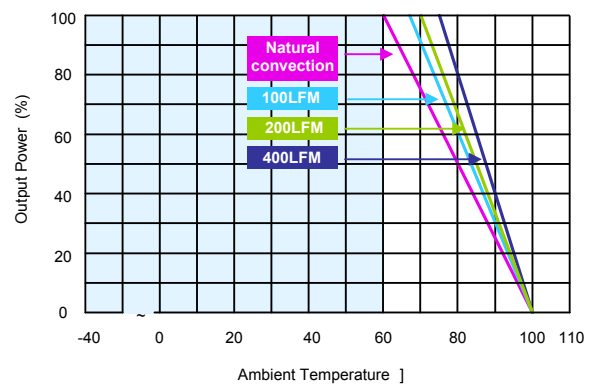

Derating Output Current Versus Ambient Temperature and Airflow
 $V_{in} = V_{in\ nom}$

Characteristic Curves

All test conditions are at 25°C The figures are identical for TEN 6-4811WIN (Continued)

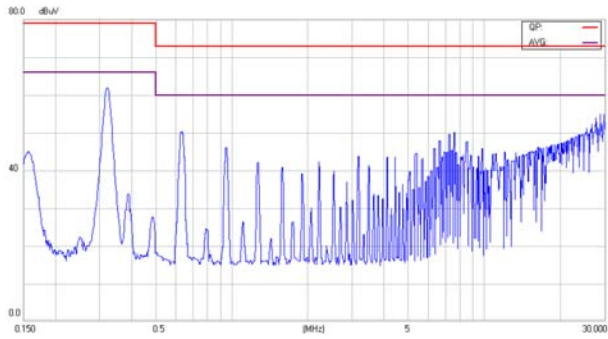

Conduction Emission of EN55022 Class A

$V_{in} = V_{in\ nom}$; Full Load

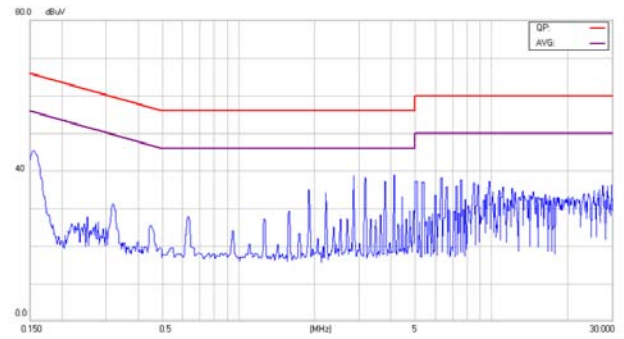

Conduction Emission of EN55022 Class B

$V_{in} = V_{in\ nom}$; Full Load

Characteristic Curves

All test conditions are at 25°C The figures are identical for TEN 6-4812WIN

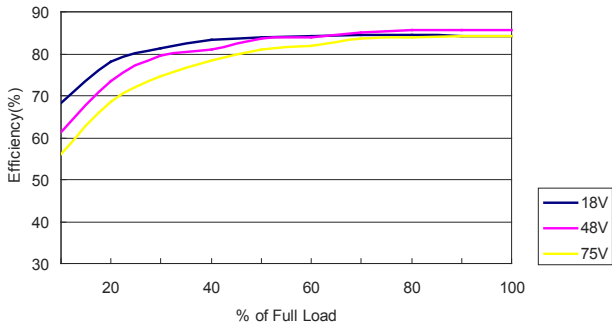

Efficiency Versus Output Current

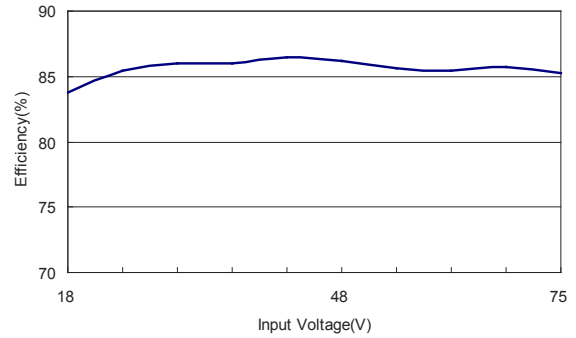

Efficiency Versus Input Voltage. Full Load

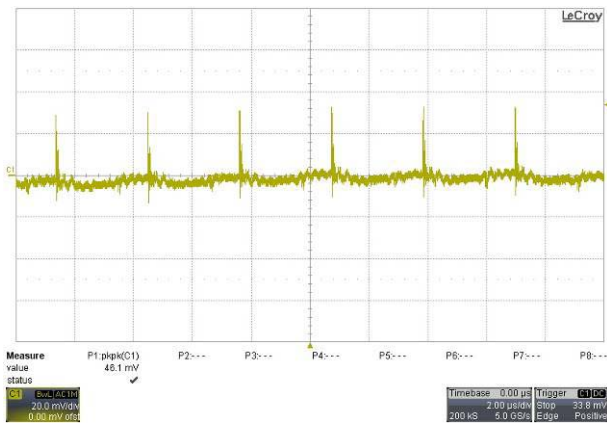

Typical Output Ripple and Noise.
 $V_{in} = V_{in\ nom}$; Full Load; T_A

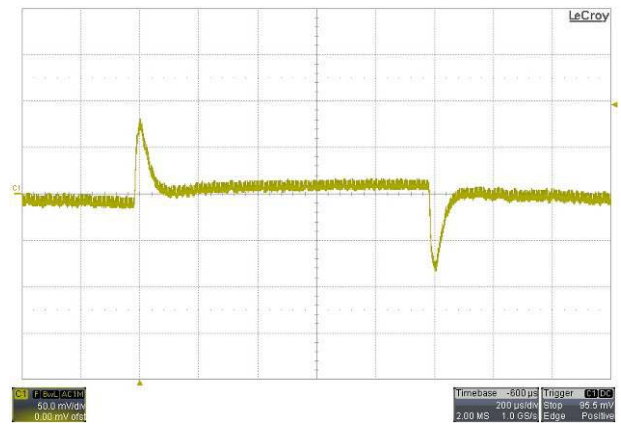

Transient Response to Dynamic Load Change from 100% to 75% of Full Load ; $V_{in} = V_{in\ nom}$

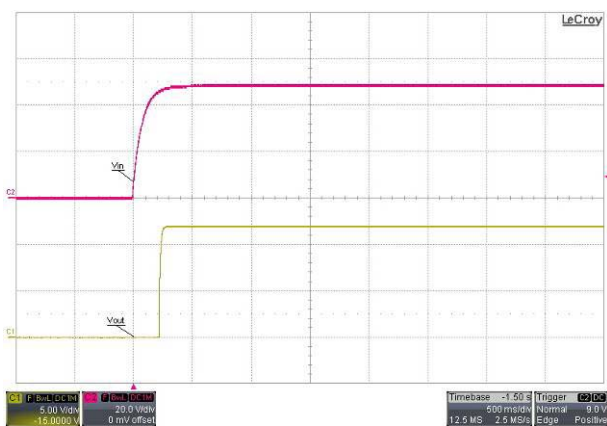

Typical Input Start-Up and Output Rise Characteristic
 $V_{in} = V_{in\ nom}$; Full Load

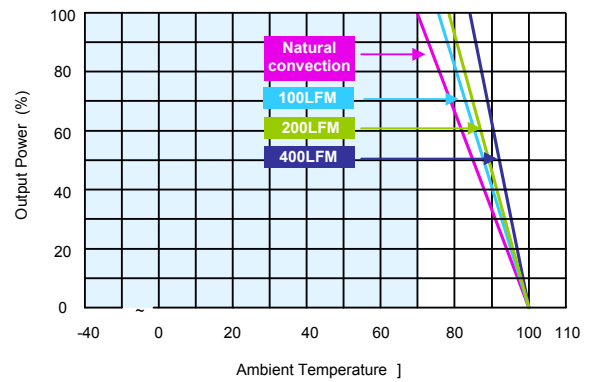

Derating Output Current Versus Ambient Temperature and Airflow
 $V_{in} = V_{in\ nom}$

Characteristic Curves

All test conditions are at 25°C The figures are identical for TEN 6-4812WIN (Continued)

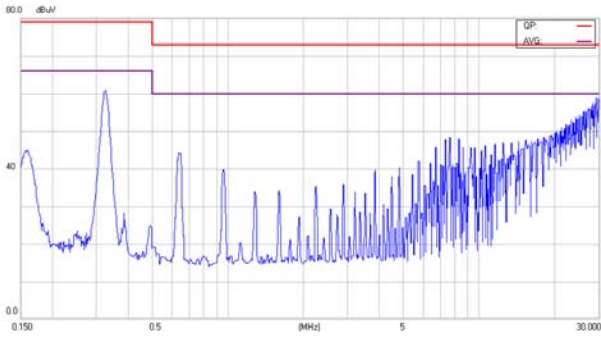

Conduction Emission of EN55022 Class A

$V_{in} = V_{in\ nom}$; Full Load

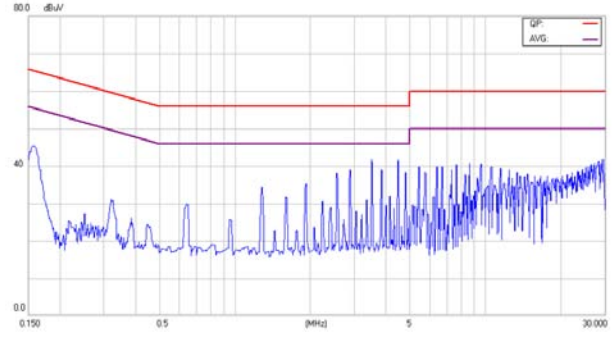

Conduction Emission of EN55022 Class B

$V_{in} = V_{in\ nom}$; Full Load

Characteristic Curves

All test conditions are at 25°C The figures are identical for TEN 6-4813WIN

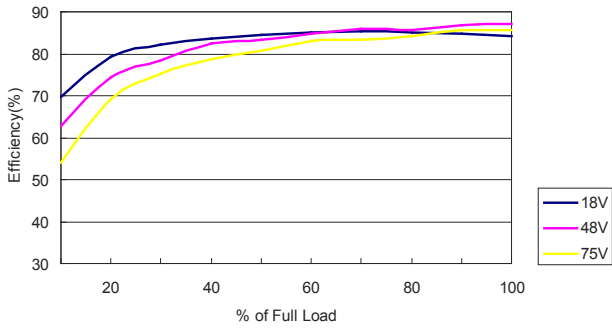

Efficiency Versus Output Current

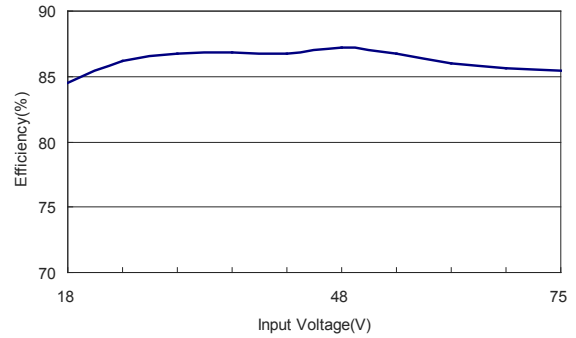

Efficiency Versus Input Voltage. Full Load

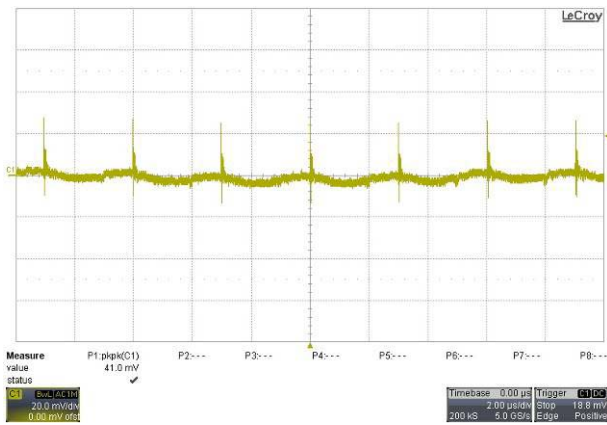

Typical Output Ripple and Noise.
 $V_{in} = V_{in\ nom}$; Full Load; T_A

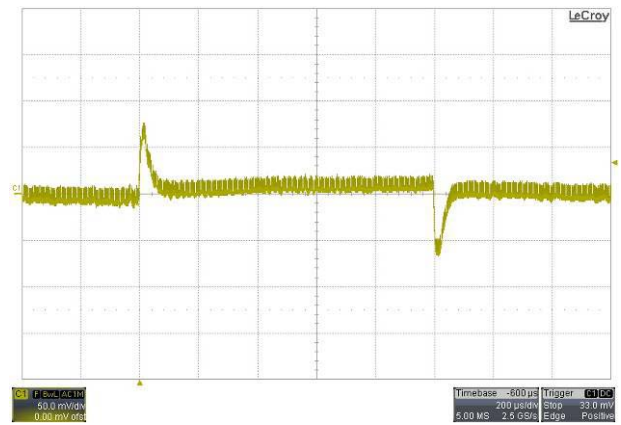

Transient Response to Dynamic Load Change from 100% to 75% of Full Load; $V_{in} = V_{in\ nom}$

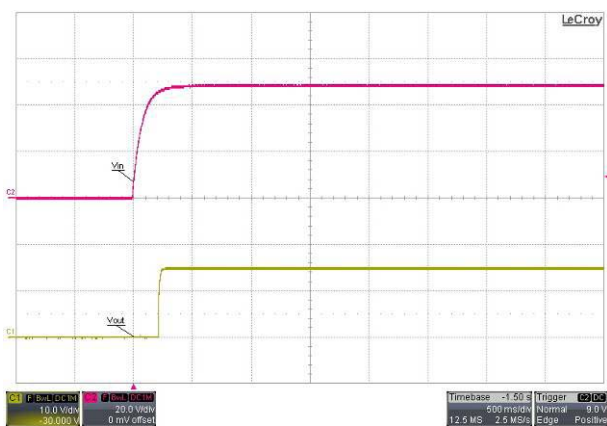

Typical Input Start-Up and Output Rise Characteristic
 $V_{in} = V_{in\ nom}$; Full Load

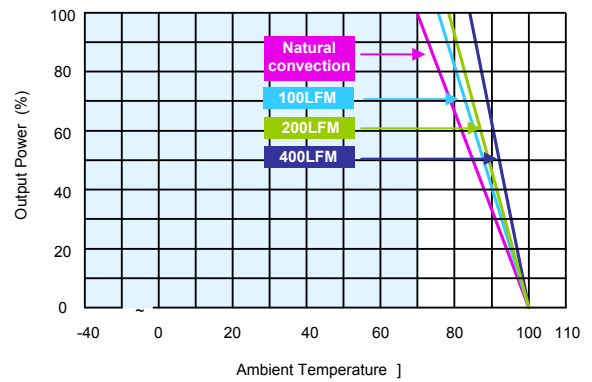

Derating Output Current Versus Ambient Temperature and Airflow
 $V_{in} = V_{in\ nom}$

Characteristic Curves

All test conditions are at 25°C The figures are identical for TEN 6-4813WIN (Continued)

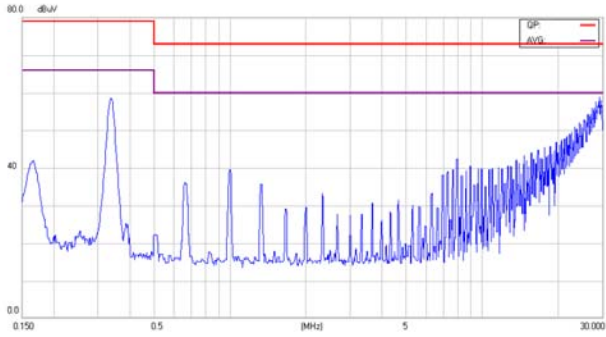

Conduction Emission of EN55022 Class A

$V_{in} = V_{in\ nom}$; Full Load

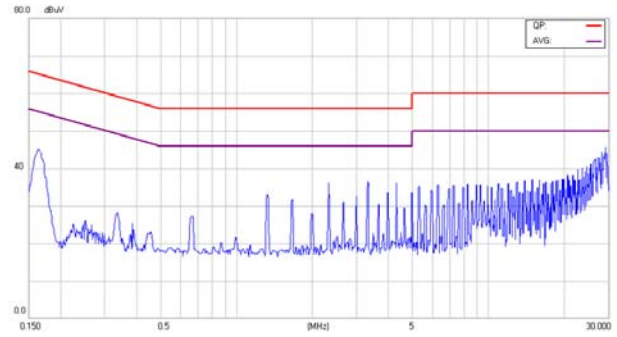

Conduction Emission of EN55022 Class B

$V_{in} = V_{in\ nom}$; Full Load

Characteristic Curves

All test conditions are at 25°C The figures are identical for TEN 6-4815WIN

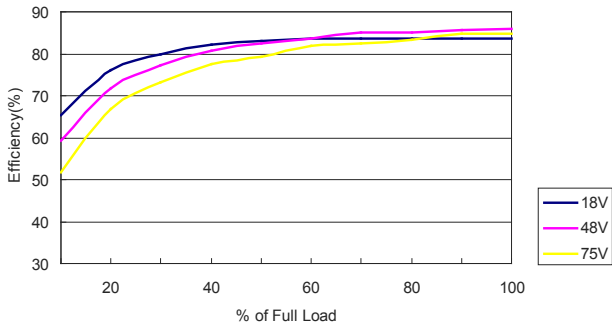

Efficiency Versus Output Current

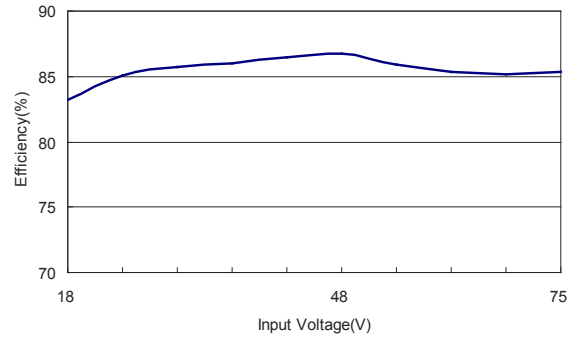

Efficiency Versus Input Voltage. Full Load

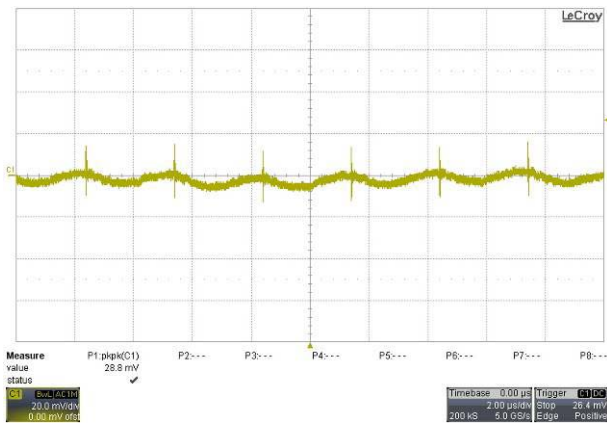

Typical Output Ripple and Noise.
 $V_{in} = V_{in nom}$; Full Load; T_A

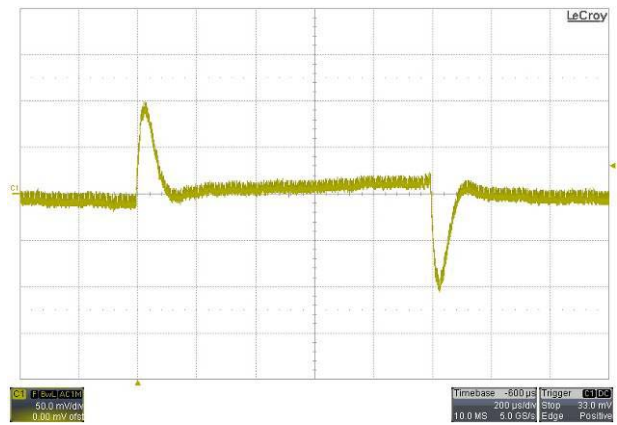

Transient Response to Dynamic Load Change from 100% to 75% of Full Load ; $V_{in} = V_{in nom}$

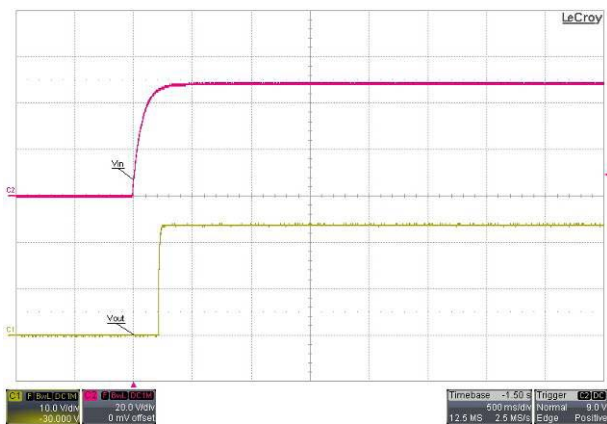

Typical Input Start-Up and Output Rise Characteristic
 $V_{in} = V_{in nom}$; Full Load

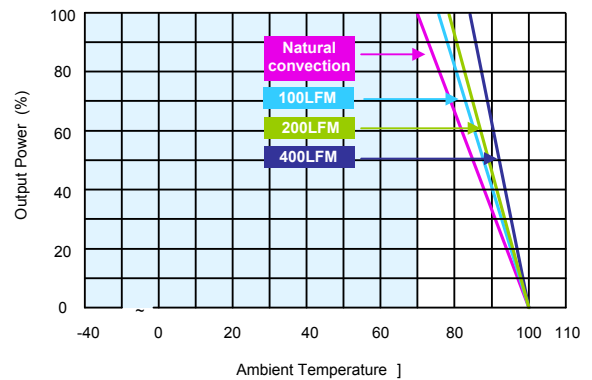

Derating Output Current Versus Ambient Temperature and Airflow
 $V_{in} = V_{in nom}$

Characteristic Curves

All test conditions are at 25°C The figures are identical for TEN 6-4815WIN (Continued)

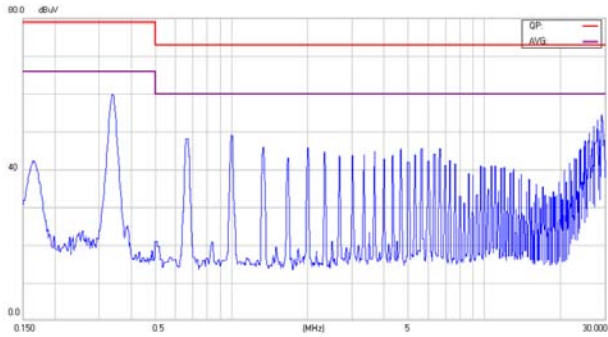

Conduction Emission of EN55022 Class A

$V_{in} = V_{in\ nom}$; Full Load

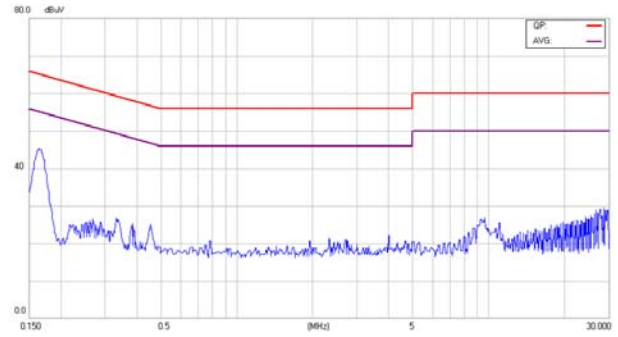

Conduction Emission of EN55022 Class B

$V_{in} = V_{in\ nom}$; Full Load

Characteristic Curves

All test conditions are at 25°C The figures are identical for TEN 6-4821WIN

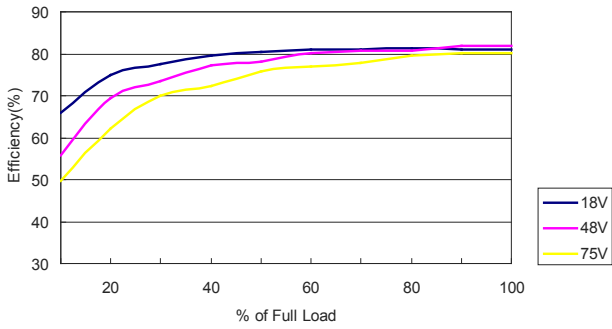

Efficiency Versus Output Current

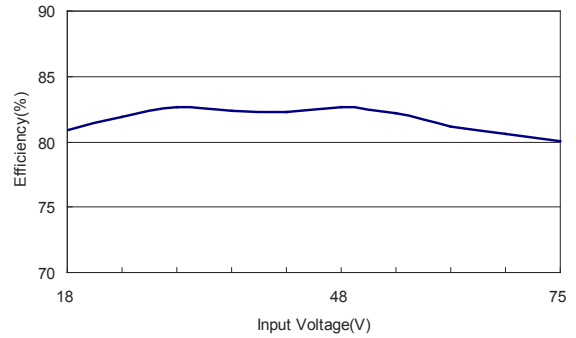

Efficiency Versus Input Voltage. Full Load

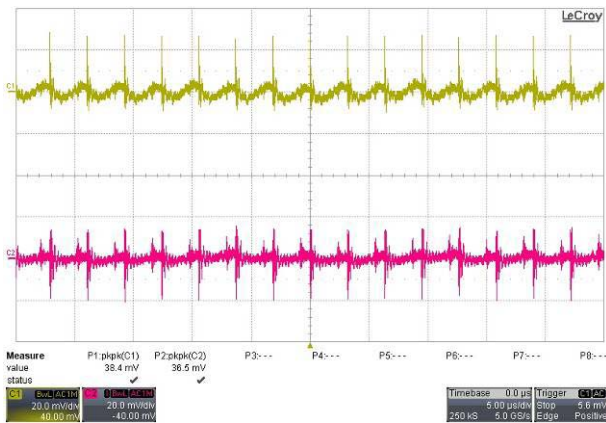

Typical Output Ripple and Noise.
 $V_{in} = V_{in\ nom}$; Full Load; T_A

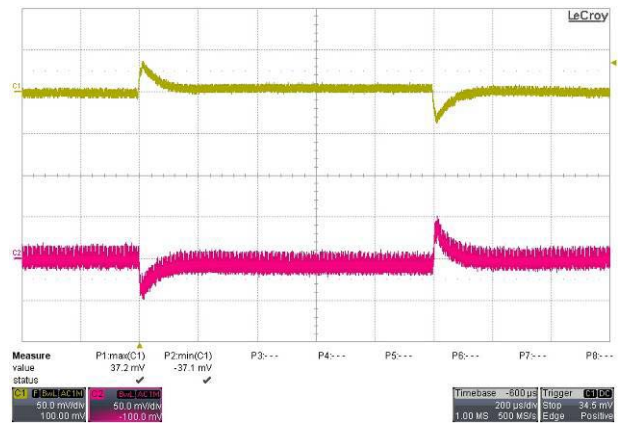

Transient Response to Dynamic Load Change from 100% to 75% of Full Load ; $V_{in} = V_{in\ nom}$

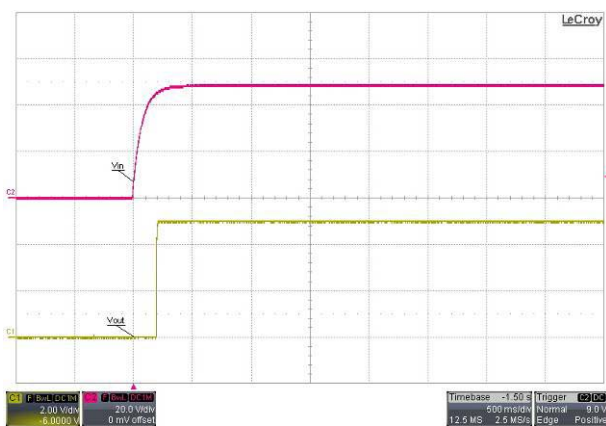

Typical Input Start-Up and Output Rise Characteristic
 $V_{in} = V_{in\ nom}$; Full Load

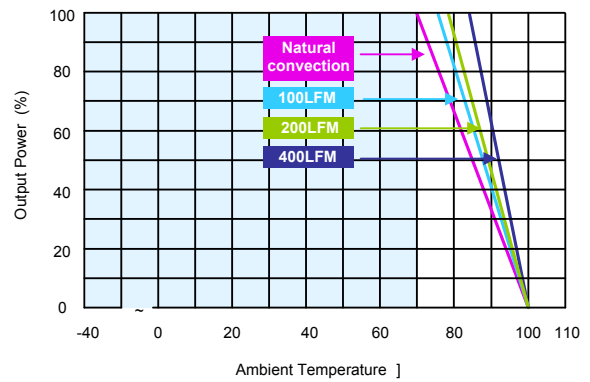

Derating Output Current Versus Ambient Temperature and Airflow
 $V_{in} = V_{in\ nom}$

Characteristic Curves

All test conditions are at 25°C The figures are identical for TEN 6-4821WIN (Continued)

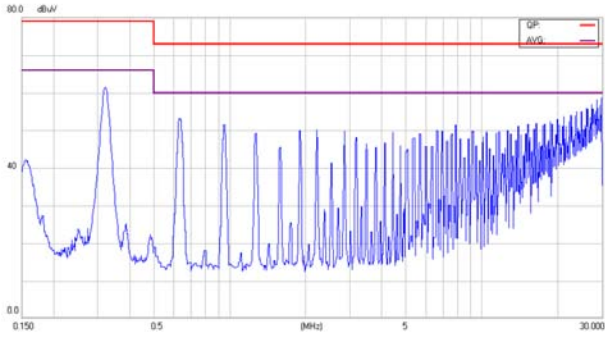

Conduction Emission of EN55022 Class A

$V_{in} = V_{in\ nom}$; Full Load

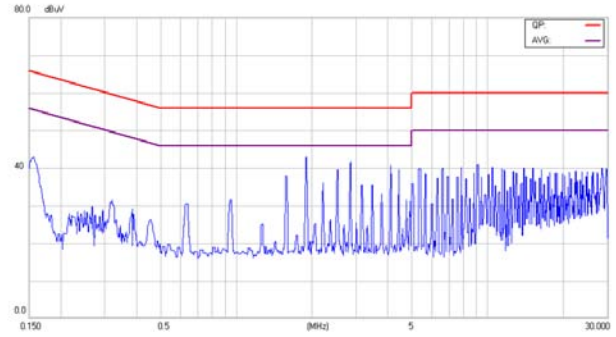

Conduction Emission of EN55022 Class B

$V_{in} = V_{in\ nom}$; Full Load

Characteristic Curves

All test conditions are at 25°C The figures are identical for TEN 6-4822WIN

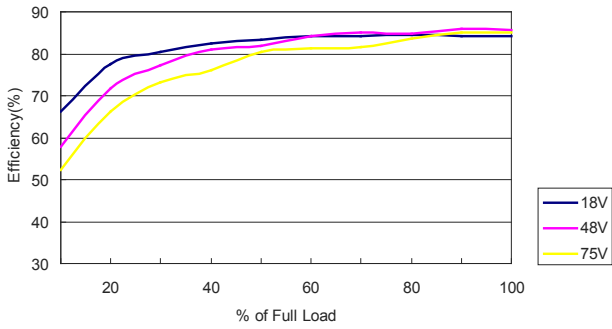

Efficiency Versus Output Current

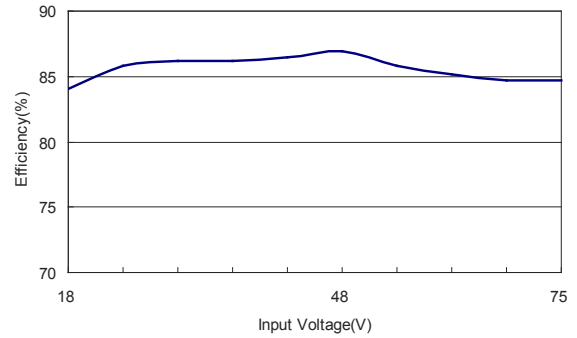

Efficiency Versus Input Voltage. Full Load

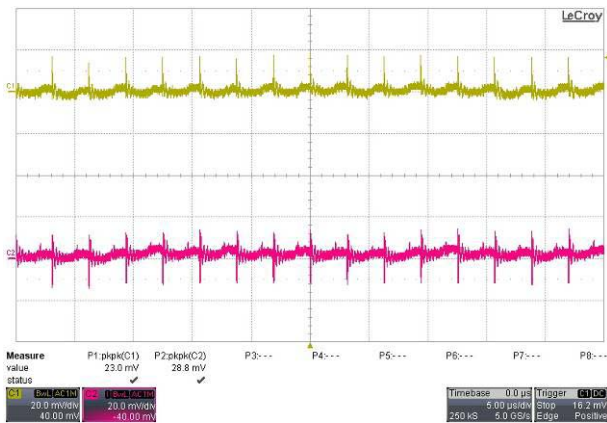

Typical Output Ripple and Noise.
 $V_{in} = V_{in nom}$; Full Load; T_A

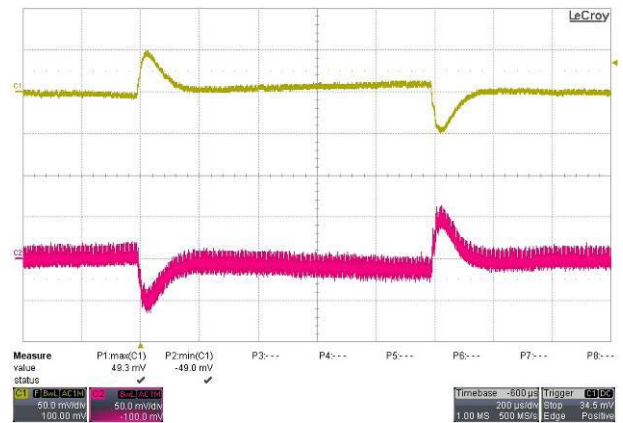

Transient Response to Dynamic Load Change from 100% to 75% of Full Load ; $V_{in} = V_{in nom}$

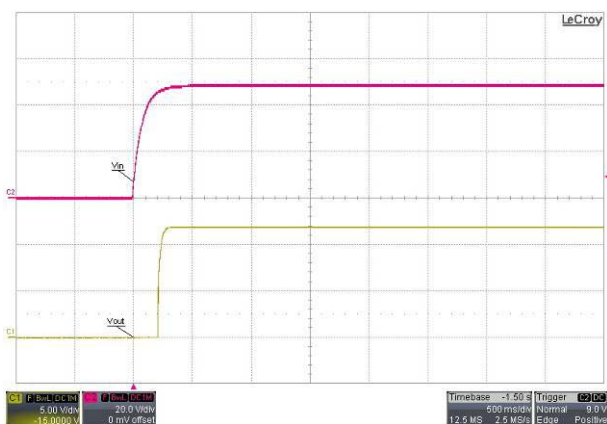

Typical Input Start-Up and Output Rise Characteristic
 $V_{in} = V_{in nom}$; Full Load

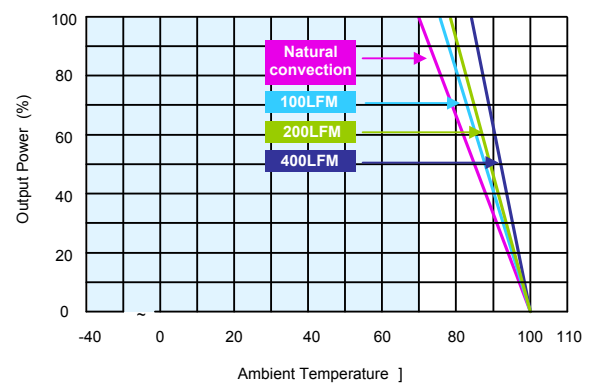

Derating Output Current Versus Ambient Temperature and Airflow
 $V_{in} = V_{in nom}$

Characteristic Curves

All test conditions are at 25°C The figures are identical for TEN 6-4822WIN (Continued)

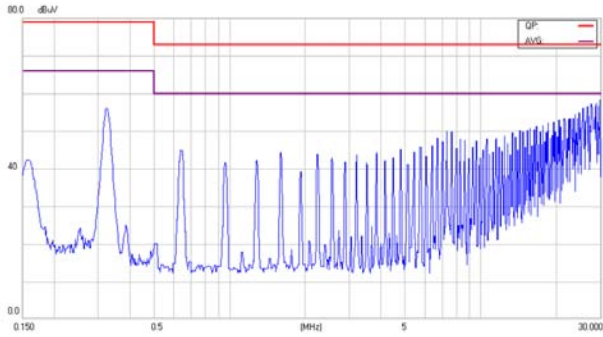

Conduction Emission of EN55022 Class A

$V_{in} = V_{in\ nom}$; Full Load

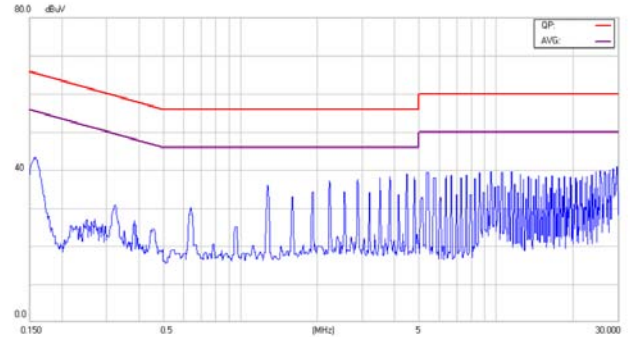

Conduction Emission of EN55022 Class B

$V_{in} = V_{in\ nom}$; Full Load

Characteristic Curves

All test conditions are at 25°C The figures are identical for TEN 6-4823WIN

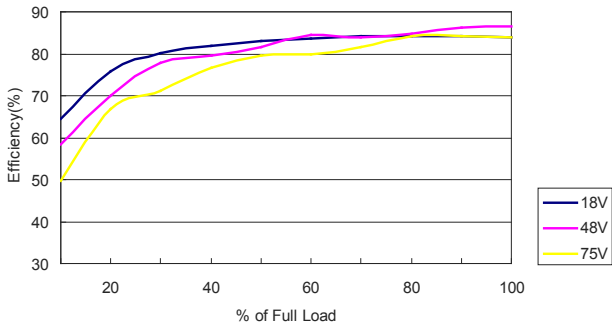

Efficiency Versus Output Current

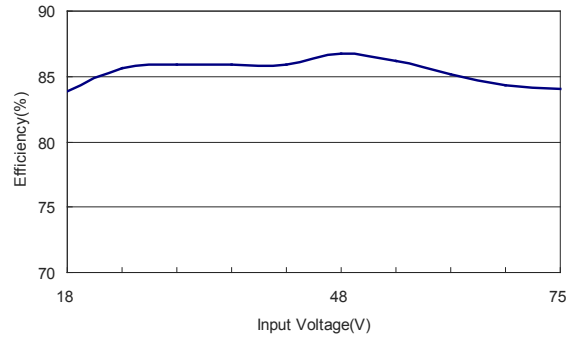

Efficiency Versus Input Voltage. Full Load

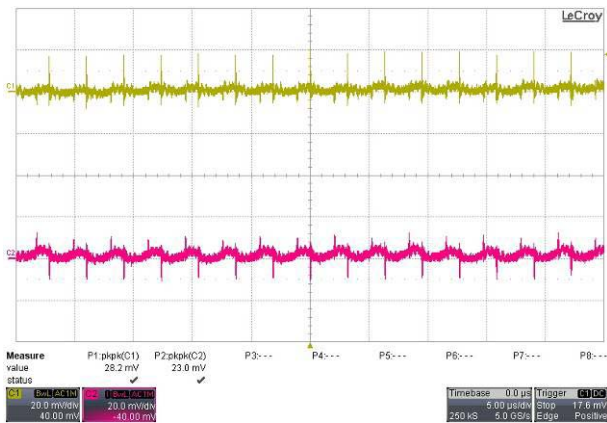

Typical Output Ripple and Noise.
 $V_{in} = V_{in\ nom}$; Full Load; T_A

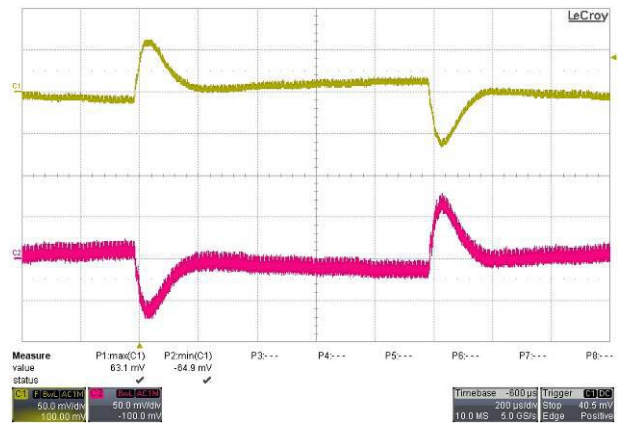

Transient Response to Dynamic Load Change from 100% to 75% of Full Load; $V_{in} = V_{in\ nom}$

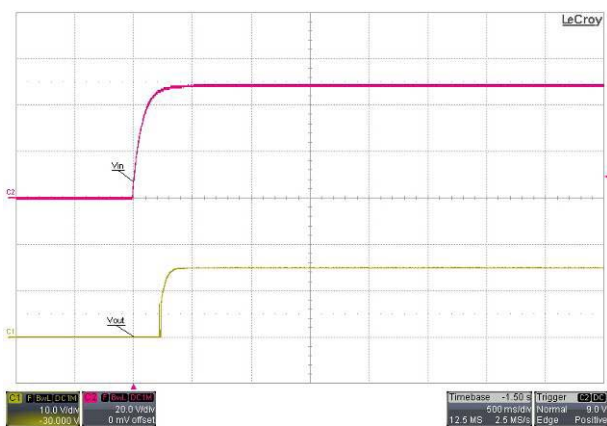

Typical Input Start-Up and Output Rise Characteristic
 $V_{in} = V_{in\ nom}$; Full Load

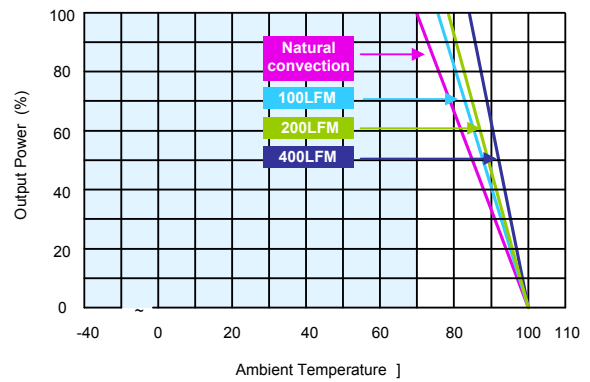

Derating Output Current Versus Ambient Temperature and Airflow
 $V_{in} = V_{in\ nom}$

Characteristic Curves

All test conditions are at 25°C The figures are identical for TEN 6-4823WIN (Continued)

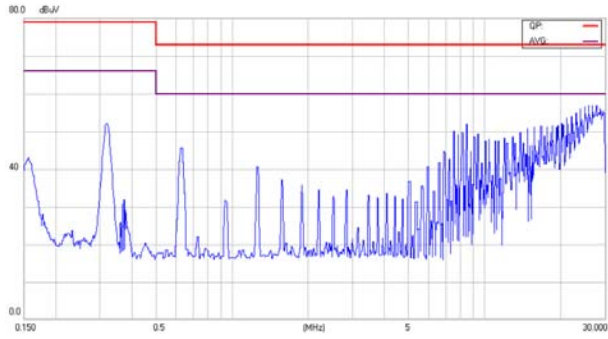

Conduction Emission of EN55022 Class A

$V_{in} = V_{in\ nom}$; Full Load

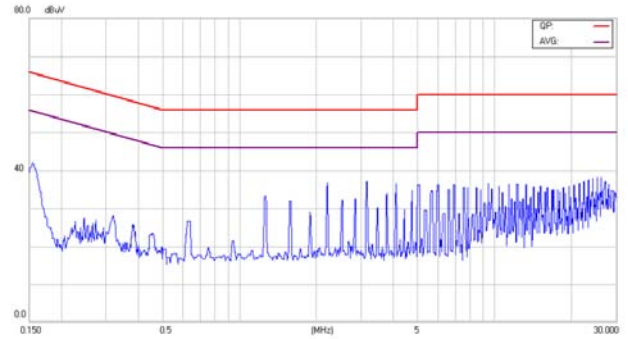

Conduction Emission of EN55022 Class B

$V_{in} = V_{in\ nom}$; Full Load

Testing Configurations

Input reflected-ripple current measurement test up

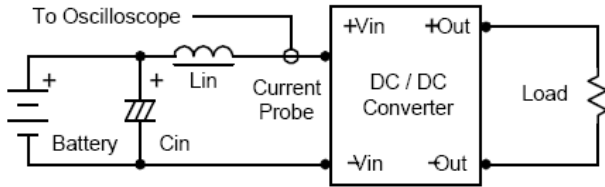

Component	Value	Reference
L	4.7μH	----
C	220μF (ESR<1.0Ω at 100KHz)	Aluminum Electrolytic Capacitor

Peak-to-peak output ripple & noise measurement test up

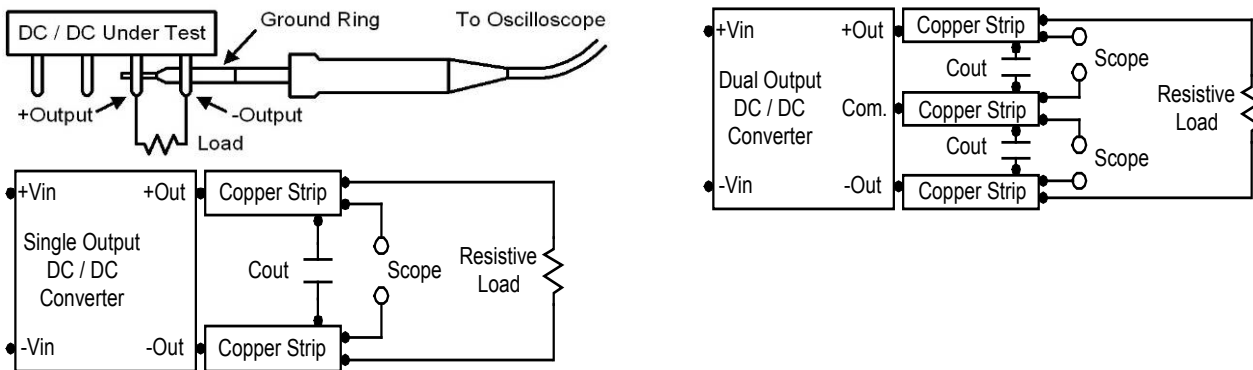

Output voltage and efficiency measurement test up

$$Efficiency = \left(\frac{V_{out} \times I_{out}}{V_{in} \times I_{in}} \right) \times 100\% = [\%]$$

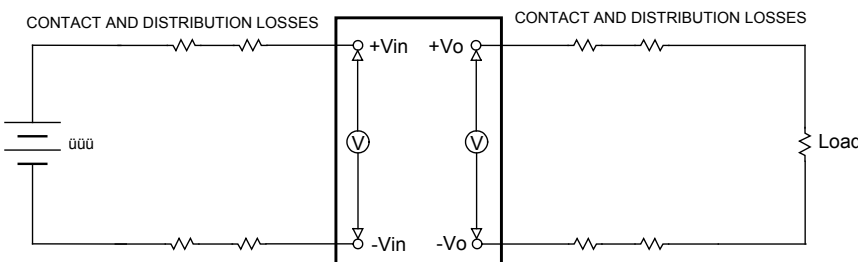

EMC considerations

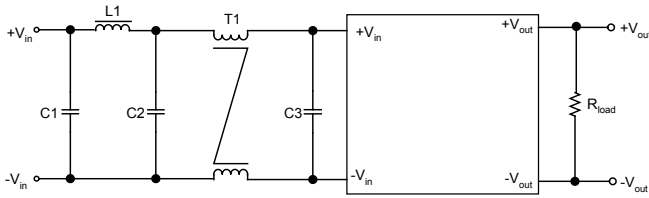

For TEN 6 Single Output

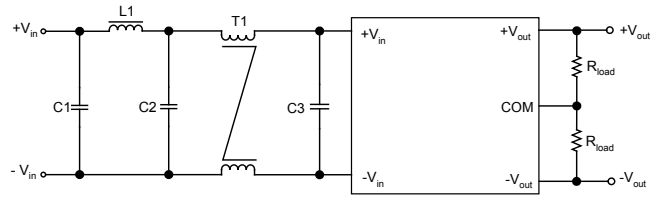

For TEN 6 Dual Output

Recommended circuit to comply EN55022 Class B Limits

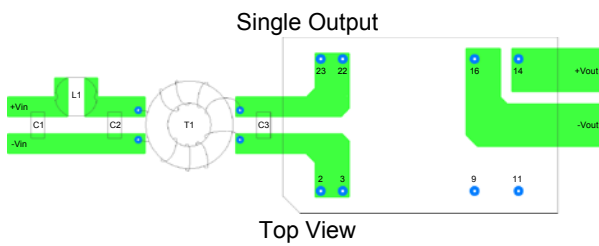

Top View

For TEN 6 Single Output

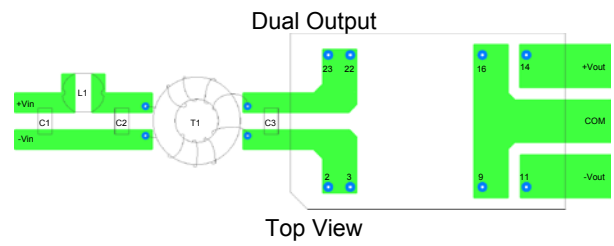

Top View

For TEN 6 Dual Output

Recommended PCB Layout with Input Filter

To: comply with EN55022 CLASS B following components are needed:

Model	Component	Value
TEN 6-24XXWIN	C1,C2,C3	4.7µF/50V 1206 X7R
	L1	4.7µH SCD0403T/1.7A
	T1	0.64mH; Common choke,core:T10*2.5*5 H5B2/HPN155φ0.37*16T
TEN 6-48XXWIN	C1,C2,C3	1µF/50V 1206 X7R
	L1	4.7µH SCD0403T/1.7A
	T1	0.81mH; Common choke,core:T10*2.5*5 H5B2/HPN155φ0.37*18T

Input Source Impedance

The power module should be connected to a low ac-impedance input source. Highly inductive source impedances can affect the stability of the power module.

In applications where power is supplied over long lines and output loading is high, it may be necessary to use a capacitor at the input to ensure startup.

Capacitor mounted close to the power module helps ensure stability of the unit, it is recommended to use a good quality low Equivalent Series Resistance ($ESR < 1.0 \Omega$ at 100 KHz) capacitor of a $4.7\mu F$ for the 24V input devices and a $2.2\mu F$ for the 48V devices.

Output Over Current Protection

To provide protection in a fault (output overload) condition, the unit is equipped with internal current limiting circuitry and can endure current limiting for an unlimited duration. At the point of current-limit inception, the unit shifts from voltage control to current control. The unit operates normally once the output current is brought back into its specified range.

Short Circuitry Protection

Continuous, hiccup and auto-recovery mode. During short circuit, converter still shut down, The average current during this condition will be very low and the device will be safe in this condition.

Mechanical Dimensions

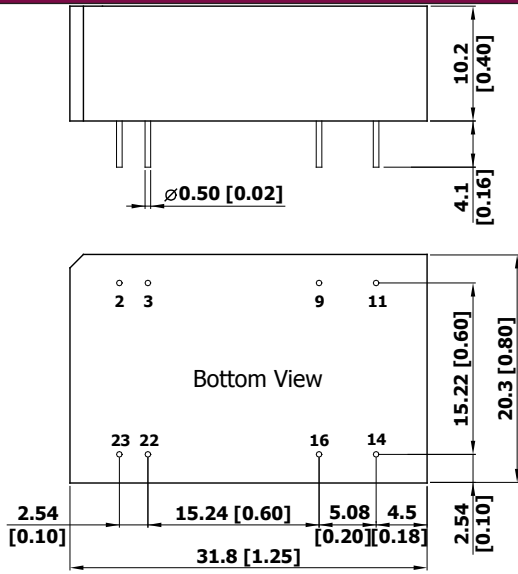

Pin Connections

Pin	Single Output	Dual Output
2	-Vin	-Vin
3	-Vin	-Vin
9	No Pin	Common
11	NC	-Vout
14	+Vout	+Vout
16	-Vout	Common
22	+Vin	+Vin
23	+Vin	+Vin

1. All dimensions in mm (inches)
Tolerance: X.X±0.25 (X.XX±0.01")
X.XX±0.13 (X.XXX±0.005")
2. Pin diameter <-> 0.5 ±0.05 (0.02±0.002)

Weight:12.7g

Recommended Pad Layout for Single & Dual Output Converter

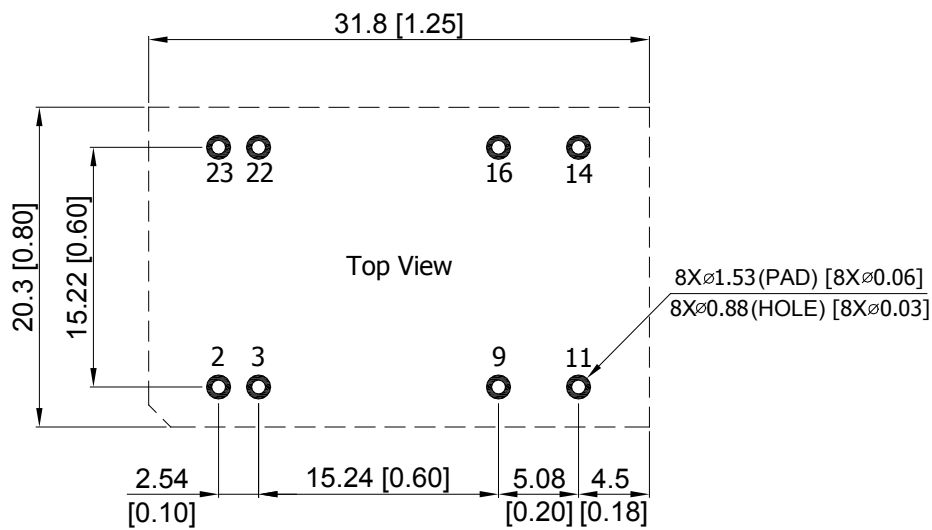

1. All dimensions in mm (inches)
Tolerance: x.x ±0.25mm (x.xx ±0.01")
x.xx ±0.13mm (x.xxx ±0.005")
2. Pin diameter <-> 0.5 ±0.05 (0.02±0.002")

Soldering and Reflow Considerations

Lead free wave solder profile for TEN 6WIN Series

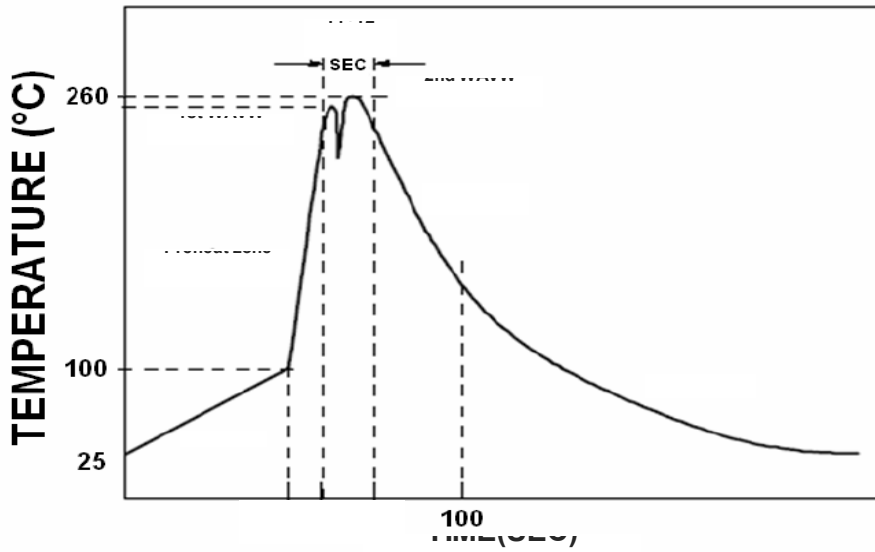

Packaging Information

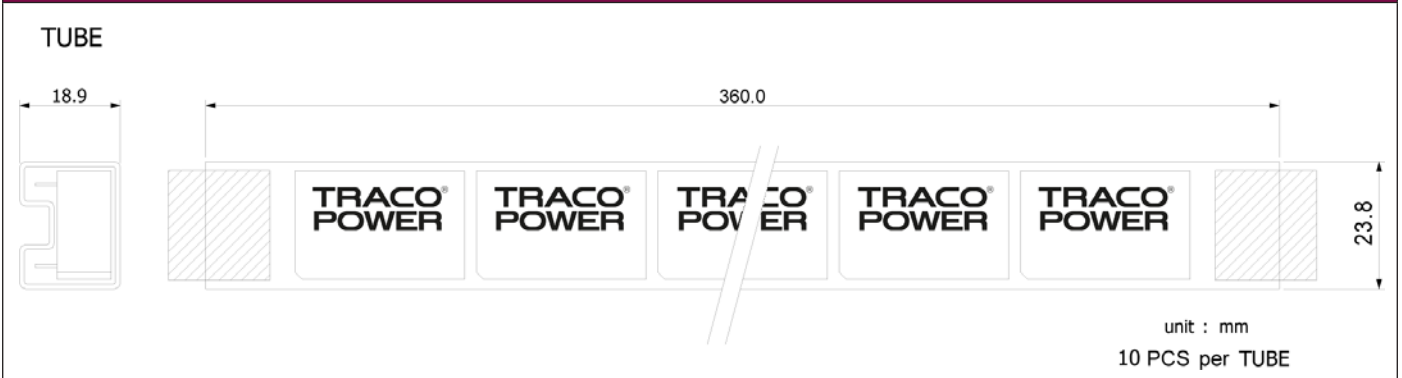

Part Number Structure

TEN 6 2415WIN

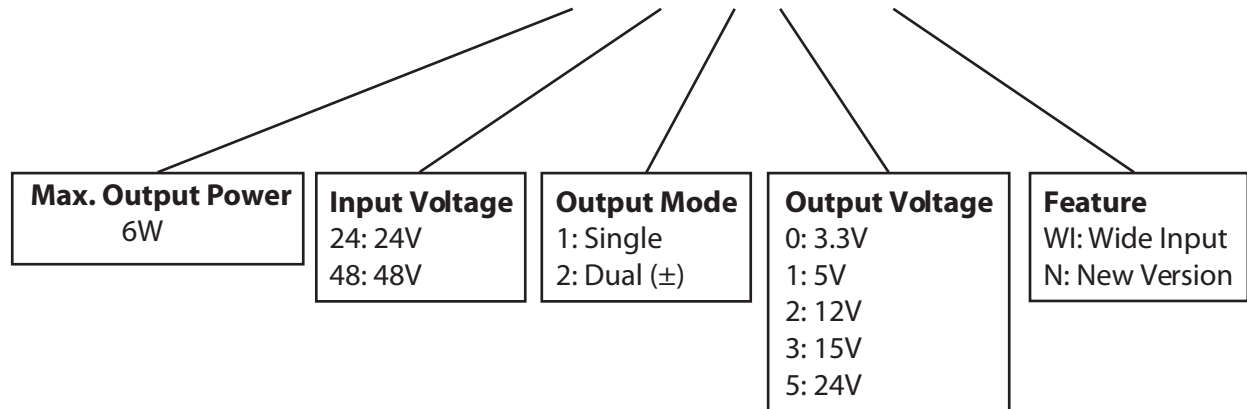

Model Number	Input Range (VDC)	Output Voltage (VDC)	Max. Output Current (mA)	Input Current at Full Load ⁽¹⁾ (mA)	Efficiency ⁽²⁾ (%)
TEN 6-2410WIN	9-36	3.3	1200	214	77
TEN 6-2411WIN	9-36	5	1200	313	80
TEN 6-2412WIN	9-36	12	500	298	84
TEN 6-2413WIN	9-36	15	400	298	84
TEN 6-2415WIN	9-36	24	250	298	84
TEN 6-2421WIN	9-36	± 5	± 500	260	80
TEN 6-2422WIN	9-36	± 12	± 250	298	84
TEN 6-2423WIN	9-36	± 15	± 200	298	84
TEN 6-4810WIN	18-75	3.3	1200	107	77
TEN 6-4811WIN	18-75	5	1200	156	80
TEN 6-4812WIN	18-75	12	500	149	84
TEN 6-4813WIN	18-75	15	400	149	84
TEN 6-4815WIN	18-75	24	250	149	84
TEN 6-4821WIN	18-75	± 5	± 500	130	80
TEN 6-4822WIN	18-75	± 12	± 250	149	84
TEN 6-4823WIN	18-75	± 15	± 200	149	84

Note 1. Maximum value at nominal input voltage and full load of standard type.

Note 2. Typical value at nominal input voltage and full load.

Safety and Installation Instruction

Fusing Consideration

Caution: This power module is not internally fused. An input line fuse must always be used.

This encapsulated power module can be used in a wide variety of applications, ranging from simple stand-alone operation to an integrated part of sophisticated power architecture. To maximum flexibility, internal fusing is not included; however, to achieve maximum safety and system protection, always use an input line fuse. The safety agencies require a normal-blow fuse in 24Vin, 48Vin with maximum rating of 1500mA, 800mA. Based on the information provided in this data sheet on Inrush energy and maximum dc input current; the same type of fuse with lower rating can be used. Refer to the fuse manufacturer's data for further information.

MTBF and Reliability

The MTBF of TEN 6WIN series of DC/DC converters has been calculated using MIL-HDBK 217F NOTICE2, Operating Ambient Temperature 25C, Ground Benign.

Unit	Model	MTBF
Hours	TEN 6-2410WIN	1,019,056
	TEN 6-2411WIN	1,037,344
	TEN 6-2412WIN	1,057,641
	TEN 6-2413WIN	988,142
	TEN 6-2415WIN	1,104,606
	TEN 6-2421WIN	1,031,034
	TEN 6-2422WIN	1,076,774
	TEN 6-2423WIN	1,073,307
	TEN 6-4810WIN	917,684
	TEN 6-4811WIN	1,004,117
	TEN 6-4812WIN	1,089,443
	TEN 6-4813WIN	1,149,161
	TEN 6-4815WIN	1,107,910
	TEN 6-4821WIN	996,810
	TEN 6-4822WIN	1,055,632
TEN 6-4823WIN	1,104,606	

Specifications can be changed without notice

Features

- ◆ Wide 4:1 input voltage range
- ◆ High efficiency
- ◆ Operating temperature range
-40°C to +85°C
- ◆ No minimum load required
- ◆ Models with 1'500 VDC and 3'000 VDC
I/O isolation (functional insulation)
- ◆ Input filter meets EN 55022, class A
- ◆ Overload protection
- ◆ DIP-24 plastic package
- ◆ Industry standard pinout
- ◆ 3-year product warranty

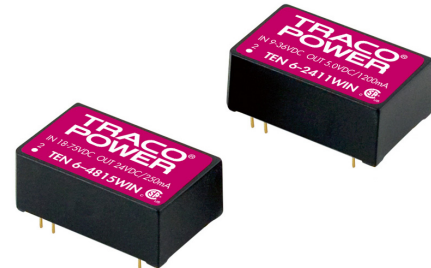

The TEN-6WIN series is designed for an optimized cost/performance ratio of DC/DC converters with output power of 6 Watt.

General features like no minimum load requirement, overload protection, internal filter for EN55022 class A and high efficiency make these converters easy to design in. With the popular DIP-24 standard package they are also a drop in replacement for many cost critical applications.

Models

Order code		Input voltage range	Output voltage	Output current max.	Efficiency typ.
1'500 VDC isolation	3'000 VDC isolation				
TEN 6-2410WIN	TEN 6-2410WIN-HI	9 – 36 VDC (24 VDC nominal)	3.3 VDC	1200 mA	77 %
TEN 6-2411WIN	TEN 6-2411WIN-HI		5 VDC	1200 mA	80 %
TEN 6-2412WIN	TEN 6-2412WIN-HI		12 VDC	500 mA	84 %
TEN 6-2413WIN	TEN 6-2413WIN-HI		15 VDC	400 mA	84 %
TEN 6-2415WIN	TEN 6-2415WIN-HI		24 VDC	250 mA	84 %
TEN 6-2421WIN	TEN 6-2421WIN-HI		±5 VDC	±500 mA	80 %
TEN 6-2422WIN	TEN 6-2422WIN-HI		±12 VDC	±250 mA	84 %
TEN 6-2423WIN	TEN 6-2423WIN-HI		±15 VDC	±200 mA	84 %
TEN 6-4810WIN	TEN 6-4810WIN-HI	18 – 75 VDC (48 VDC nominal)	3.3 VDC	1200 mA	77 %
TEN 6-4811WIN	TEN 6-4811WIN-HI		5 VDC	1200 mA	80 %
TEN 6-4812WIN	TEN 6-4812WIN-HI		12 VDC	500 mA	84 %
TEN 6-4813WIN	TEN 6-4813WIN-HI		15 VDC	400 mA	84 %
TEN 6-4815WIN	TEN 6-4815WIN-HI		24 VDC	250 mA	84 %
TEN 6-4821WIN	TEN 6-4821WIN-HI		± 5 VDC	±500 mA	80 %
TEN 6-4822WIN	TEN 6-4822WIN-HI		±12 VDC	±250 mA	84 %
TEN 6-4823WIN	TEN 6-4823WIN-HI		±15 VDC	±200 mA	84 %

Input Specifications

Input current at no load	24 Vin models: 20 mA typ. 48 Vin models: 10 mA typ.
Input current at full load	24 Vin, 3.3VDC models: 215 mA typ. 24 Vin other models: 300 mA typ. 48 Vin, 3.3VDC models: 110 mA typ. 48 Vin other models: 150 mA typ.
Recommended input fuse (slow blow)	24 Vin models: 1500 mA 48 Vin models: 800 mA
Start-up voltage / under voltage shut down	24 Vin models: 9 VDC / 8.5 VDC (or lower) 48 Vin models: 18 VDC / 16 VDC (or lower)
Surge voltage (1 sec. max.)	24 Vin models: 50 V max. 48 Vin models: 100 V max.
Conducted noise	EN 55022 class A

Output Specifications

Voltage set accuracy	±2 %
Regulation	– Input variation Vin min. to Vin max. 0.5 % max. – Load variation 0 – 100 % single output models: 1.2 % max. dual output models balanced load: 1.2 % max. dual output models 50%/100% unbalanced load: 3.0 % max.
Minimum load	not required
Temperature coefficient	±0.02 %/K
Ripple and noise (20 MHz Bandwidth)	80 mVp-p max.
Dynamic load response (change from 75 % to 100 % load)	±3 % peak variation typ. 300 µS response time typ.
Current limitation	150 % of lout max. typ., constant power
Short circuit protection	continuous, automatic recovery
Capacitive load	3.3 & 5.0 VDC models: 470 µF max. 12 & 15 VDC models: 100 µF max. 24 VDC models: 47 µF max. dual output models: 100 µF max. (each output)

General Specifications

Temperature ranges	– Operating –40°C to +85°C – Case temperature +100°C max. – Storage –50°C to +125°C
Derating	3.3 & 5.0 VDC models: 2.5 %/K above +60°C other models: 3.3 %/K above +70°C
Humidity (non condensing)	95 % rel H max.
Reliability, calculated MTBF (MIL-HDBK-217F, at +25°C, ground benign)	>800'000 h
Isolation voltage (input/output, 60 sec., functional insulation)	standard models: 1'500 VDC models with suffix -H: 3'000 VDC
Isolation capacitance (input/output, 100 KHz, 1 V)	1000 pF typ.
Isolation resistance (input/output, 500 VDC)	>1'000 M Ohm
Switching frequency	330 kHz typ.

All specifications valid at nominal input voltage, full load and +25°C after warm-up time unless otherwise stated.

General Specifications

Safety standards		UL/cUL 60950-1, IEC/EN 60950-1
Safety approvals	<ul style="list-style-type: none"> - CSA certificate according UL 60950-1 - CB test certificate according IEC 60950-1 	www.tracopower.com/products/ten6win-csa.pdf www.tracopower.com/products/ten6win-cb.pdf
Environmental compliance	<ul style="list-style-type: none"> - Reach - RoHS 	www.tracopower.com/products/ten6win-reach.pdf RoHS directive 2011/65/EU

Physical Specifications

Casing material	non conductive plastic (UL 94V-0-rated)
Potting material	epoxy (XM-2109 & XY-2110, UL 94V-0-rated)
Weight	4.8 g (0.16 oz)
Soldering temperature (1.5mm from case for 10 sec.)	max. 260°C

Application note: www.tracopower.com/products/ten6win-application.pdf

Outline Dimensions

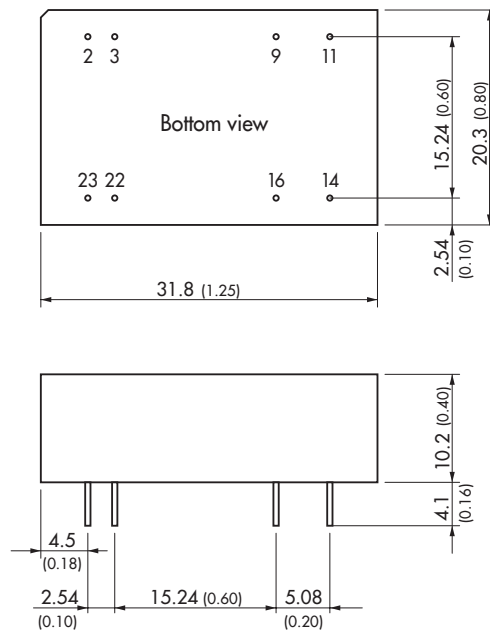

Pin-Out		
Pin	Single	Dual
2	-Vin (GND)	-Vin (GND)
3	-Vin (GND)	-Vin (GND)
9	No pin	Common
11	No function	-Vout
14	+Vout	+Vout
16	-Vout	Common
22	+Vin (Vcc)	+Vin (Vcc)
23	+Vin (Vcc)	+Vin (Vcc)

Dimensions in [mm], () = Inch
 Pin diameter $\varnothing 0.5 \pm 0.05$ (0.02 \pm 0.002)
 Tolerances ± 0.25 (± 0.01)
 Pin pitch tolerances ± 0.13 (± 0.0005)

Specifications can be changed without notice! Make sure you are using the latest documentation, downloadable at www.tracopower.com