

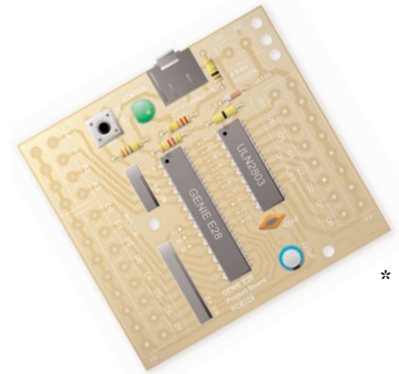

**Welcome to the GENIE ELITE range!**

The project board is ideal when you want to add intelligence to other design or electronics projects. Simply wire up your inputs and outputs and away you go!



Green status LED, controlled by output signal **ST**

Download socket (the cable plugs in here so that the GENIE microcontroller can talk to the computer)

Reset switch (starts any program running from the beginning again)

Battery connects here (red wire to '+V', black wire to '0V')

Analogue inputs **A0 to A3**

Digital inputs **D0 to D7**

GENIE E28 microcontroller (the smart bit!)

Low-power outputs signals (these are output signals **Q0 to Q7** before they are 'beefed-up' by the driver chip)

Driver chip (it contains 8 separate transistors that allow each output to control more powerful things)

**Battery power must be between 4.5 volts and 6 volts...  
...that's 3 or 4 AA-sized batteries!**

Medium-power outputs, controlled by signals **Q0 to Q7**

\* The PCB is only available as an artwork mask. It is on page 9 of this worksheet and within Circuit Wizard.

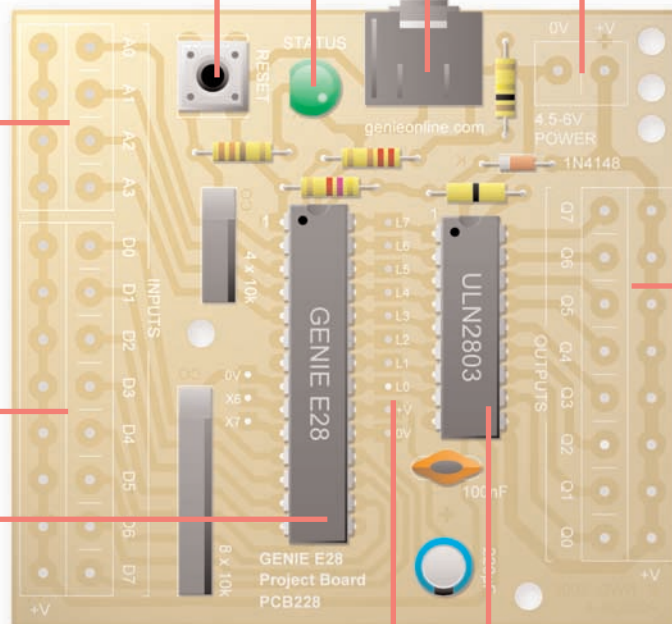



## Making the GENIE 2

Switch on the soldering iron. It will only take a few minutes for the iron to reach operating temperature. Once the soldering iron is hot, clean the soldering iron tip with a moist sponge.

Melt some solder at the chamfered end of the soldering iron tip. This is called 'tinning' and it will aid the flow of solder from the soldering iron to the copper track on the printed circuit board and component pins.

Fit each component onto the board. When fitting components such as resistors, you should use long-nosed pliers to bend the legs through 90 degrees. This will make them easier to fit.

Some of the components need to be fitted the correct way around:

- ◆ The GENIE microcontroller and the driver chip should both be positioned so that the notch points towards the download socket and the dot next to pin 1 is at the same corner as the '1' shown on the board.
- ◆ The green LED should be fitted so that the flat edge of the LED lines up with the flat edge shown on the board.
- ◆ The diode should be positioned so that the stripe on the diode matches the stripe on the board.
- ◆ When fitting the electrolytic capacitor, you need to ensure that the positive side of the capacitor (the side without the stripe) is nearest to the '+' sign on the board.
- ◆ The 4-way and 8-way in-line resistors should be fitted so that the dot on the component is at the top of the board (towards the edge on which the download socket sits).

To solder a pin, hold the soldering iron onto the board for a few seconds, then quickly touch the tip with a small amount of solder.

You should always remember to replace the soldering iron back into the stand after soldering and repeat cleaning the tip of the iron with the moist sponge before the start of each soldering operation.

Finally, cut off any excess wire or component legs for a tidy finish.

### Components List

This is what you will need:

Component	Quantity
GENIE E28 microcontroller	1
GENIE E28 project board (PCB228) *	1
ULN2803 driver	1
Download (3.5mm stereo) socket	1
28-pin DIL socket	1
18-pin DIL socket	1
Battery clip	1
3 or 4 x AA battery holder	1
1N4148 diode	1
6 x 6mm switch	1
Green LED	1
220uF electrolytic capacitor	1
100nF capacitor	1
4-way in-line 10k ohm resistor	1
8-way in-line 10k ohm resistor	1
0 ohm resistor (black, marked LK on the PCB)	1
330 ohm resistor (orange, orange, brown, gold)	1
4.7k ohm resistor (yellow, violet, red, gold)	1
22k ohm resistor (red, red, orange, gold)	1
100k ohm resistor (brown, black, yellow, gold)	1

\* The PCB is only available as an artwork mask. It is on page 9 of this worksheet and within Circuit Wizard.





## Telling the GENIE your wishes 3

For your project to work, you need to tell the GENIE microcontroller what it should do.

This involves writing a sequence of commands in a **flowchart**. Your flowchart is then sent down the cable and stored on the GENIE chip. By changing the flowchart, you can vary how the GENIE behaves.

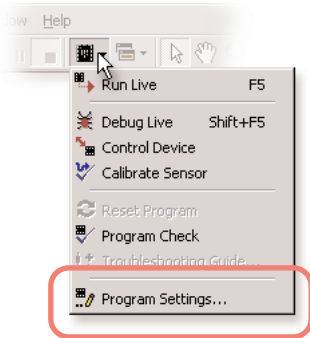

First of all, you need to tell GENIE which type of chip you are using. To do this, click on the **Microcontroller** button on the toolbar and choose **Program Settings**.

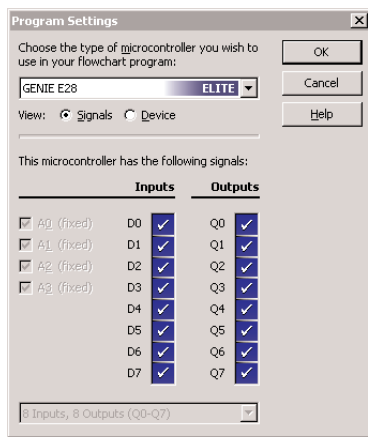

Select a **GENIE E28** chip.

The inputs and output signals for this type of microcontroller are fixed, so click on **OK** when you are ready to continue.



You can now decide which commands you want your GENIE to perform. To do this, drag commands from the **Gallery**.

See the next worksheet for flowchart ideas.

### Available Signals

These are the **input and output signals** available in your flowchart:

Input	Description
A0 to A3	Analogue
D0 to D7	Digital
Output	Description
Q0 to Q7	Medium-power





## Telling the GENIE your wishes 4

### Turning outputs on and off

You can use GENIE to turn outputs on and off.

- High** Use the **HIGH** command to turn a single output on.
- Low** Use the **LOW** command to turn a single output off.
- Outputs** Use the **OUTPUTS** command to control several outputs.

There are eight medium-power outputs on the project board (plus a green LED on output **ST**).

Double-clicking on an output command allows you to control these signals, for example:

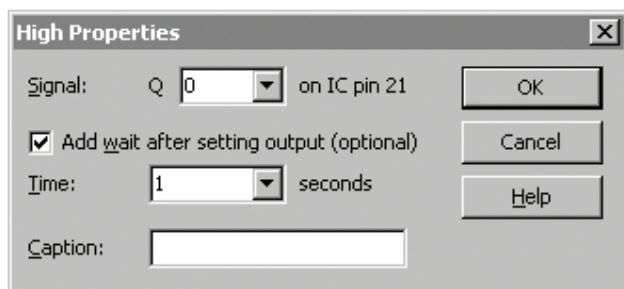

This will make the output connected to Q0 go high (if a bulb was connected, for example, the bulb would light up).

In addition to changing the output, you can also add a delay (GENIE programs run very quickly and without a wait, sometimes signals change too fast for you to see!).

The flowchart on the right uses the HIGH and LOW commands to make output Q0 flash on and off.

It loops back to make the flashing repeat.

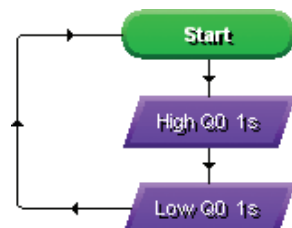

### Making sounds or playing tunes

GENIE microcontrollers can make sounds and also play musical tunes.

- Sound** Use the **SOUND** command to play a single note.
- Tune** Use the **TUNE** command to play a whole musical tune.

To make a sound, you should connect up a sounder or loudspeaker to an output (**Q0** to **Q7**) and then use the **SOUND** command as follows:

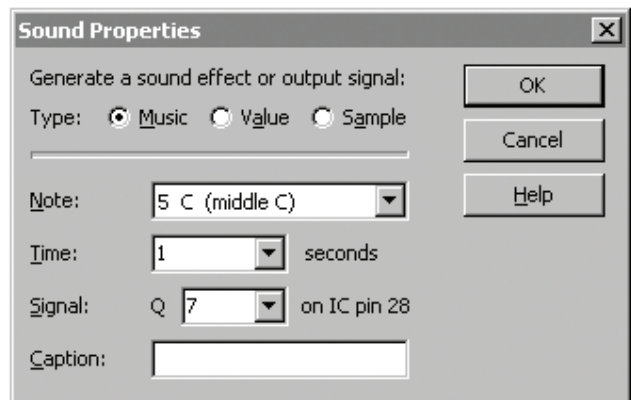

This would play the note middle C for one second.

By playing two different notes (one after the other, as shown on the right), you can create an alarm. In this flowchart, output Q0 is also made high and low (to flash a light for example).

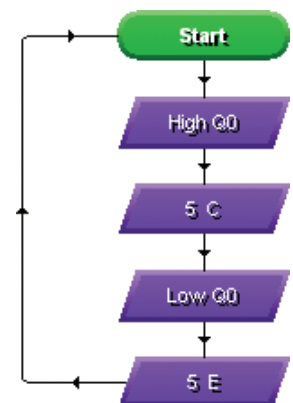

You can use the **TUNE** command to play a whole tune such as a mobile telephone ring tone (see the GENIE C08 jukebox kit to learn how you can play 2-channel stereo music).







## Telling the GENIE your wishes 5

### Responding to digital signals

Some types of signal, such as push switches, can only be either on or off. These are known as **digital** signals.



Use the **DIGITAL** command to respond to a digital signals.

The **DIGITAL** command allows you to make a decision based on whether a digital signal is either on (high) or off (low).

When a digital signal is on, it has the value '1' whereas when it is off, it has the value '0'.

Double-click on the command to select which digital inputs you wish to check. GENIE will follow the 'Y' (yes) path when the digital signal matches the chosen pattern, otherwise it will follow the 'N' (no) path.

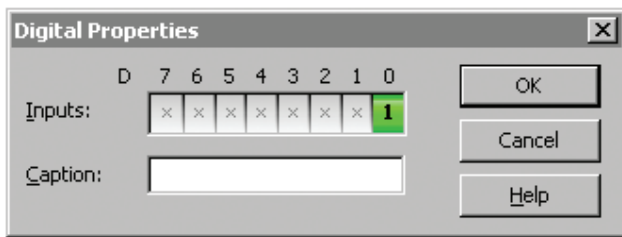

The above pattern will test if, for example, a push switch on digital input D0 is on (pressed). You can see below how to make output Q0 high whenever the switch is pressed:

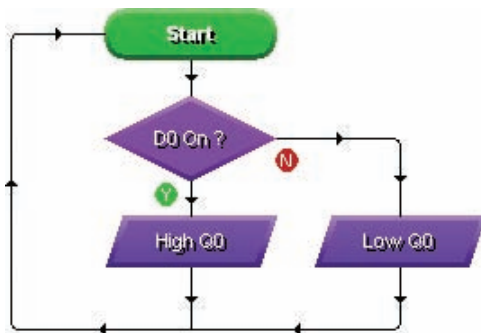

### Responding to analogue signals

Other types of signal, such as temperature or light, can be at a number of different levels. These are known as **analogue** signals.



Use the **ANALOGUE** command to respond to analogue signals.

The **ANALOGUE** command allows you to check if a signal lies within a given range.

With GENIE, analogue levels can vary between 0 (the lowest level) and 255 (the highest).

Double-click on the command to select a sensor to check and a range. GENIE will follow the 'Y' (yes) path when the signal is in range, otherwise it will follow the 'N' (no) path.

For example, to test if a light sensor on analogue signal A1 is between 0 and 100, you should enter the following:

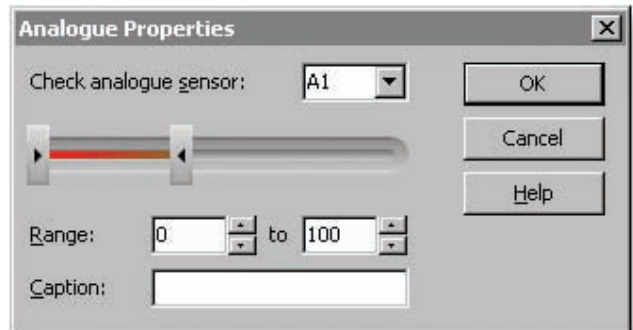

In a flowchart, this would look like:

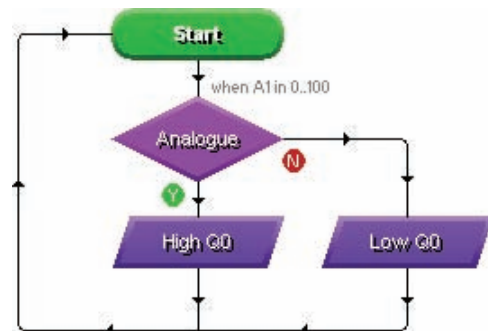



## Bringing the GENIE to life 6

Once you have written your flowchart program, you need to store it on the GENIE chip. Here's how you do it:

- 1 Wire-up the built GENIE circuit board and connect up a suitable battery power supply.
- 2 Plug the GENIE cable into the download socket on the GENIE circuit board.
- 3 Once done, the **Program** panel in **Circuit Wizard** or **GENIE Design Studio** will then show a 'Connected' message (see picture a).
- 4 Click on the **Run Live** option. Your flowchart will be transferred onto the GENIE chip—this is known as **downloading** (see picture b).

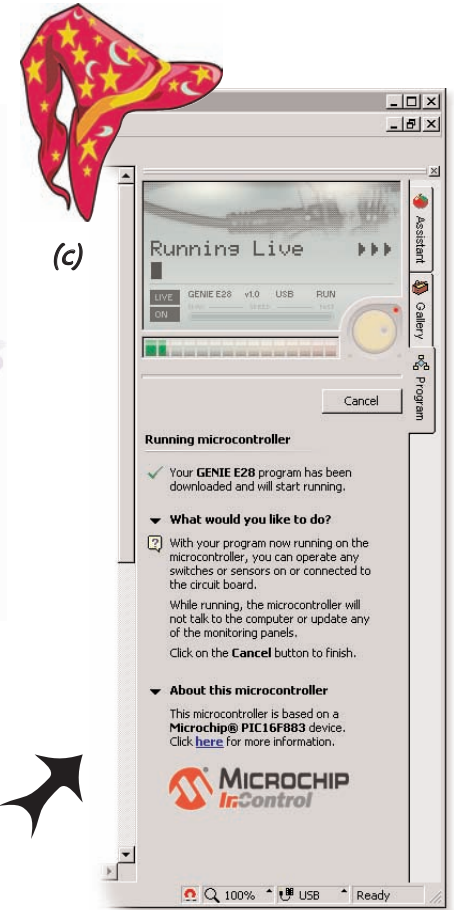
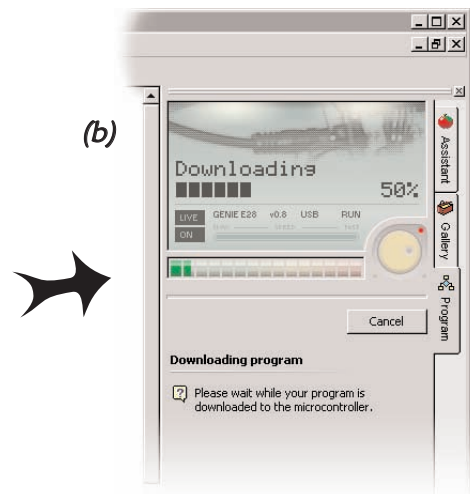
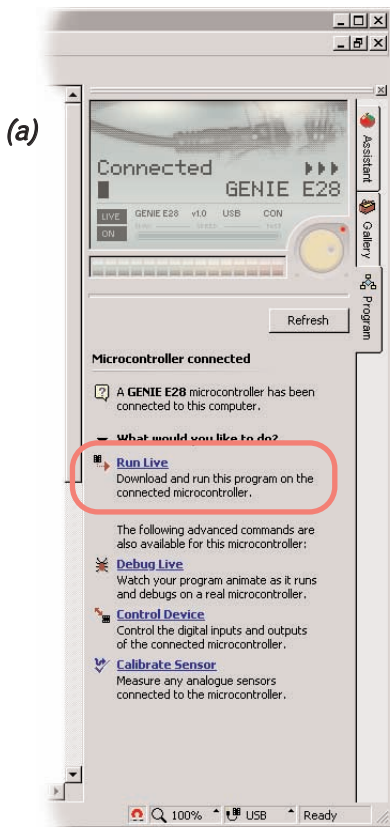

*The green status LED on the project board will flash as the download takes place. It tells you everything is OK!*

As soon as the program has been downloaded you will see the above screen (c) and GENIE will start running your flowchart.

Your GENIE project is now ready to go! You can disconnect the cable and use your GENIE board away from the computer.

**Finished!**





If you are unable to connect to a GENIE microcontroller or download a program, you should go through the following troubleshooting hints and tips.

### A Run the GENIE troubleshooting tool

The GENIE troubleshooter will automatically check your cable and software to ensure that the computer can access the GENIE cable.

To run the GENIE troubleshooter, choose **Troubleshoot GENIE...** from the **Help** menu of GENIE Design Studio 1.1 or Circuit Wizard 2.

If you have an earlier version of GENIE Design Studio or Circuit Wizard, you can download it from [www.genieonline.com/cable](http://www.genieonline.com/cable).

Step through the on-screen instructions.

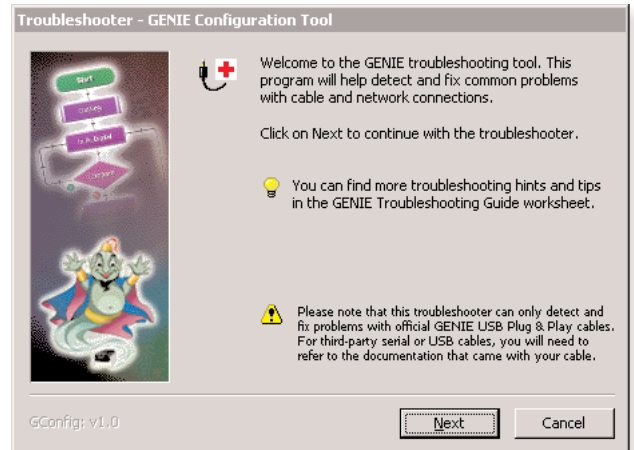

### B Step through the following checklist of common problems

#### Cable

- GENIE Design Studio and Circuit Wizard both check and report problems involving the cable that is connected. If given, follow through on the on-screen help and advice.
- Unplug the cable, wait a few seconds and then plug it back in. Windows can occasionally fail to detect that a cable has been inserted.

#### Power

- Check that the voltage of the battery is sufficient. For this board, the battery voltage should be in the range of 4.5 volts to 6 volts.
- Check the voltage level across the power connections (+V and 0V) on the board. This can identify if there is a problem with the battery clip or battery holder. Ensure that the wiring has not become loose and the batteries are properly seated in the holder.

#### Circuit

- Try plugging the cable into another GENIE board if you have one available. When powering up this circuit, the green STATUS LED should flash once (when properly connected it will flash repeatedly).
- Try with another GENIE microcontroller if possible.
- Visually inspect the board for bad solder joints or cases where soldering has incorrectly bridged pins together. Note that for the download socket, the two left-most pins should be connected together, as should the two right-most pins.

For more troubleshooting hints and tips, please read the separate **GENIE Troubleshooting Guide**.





More information **8**



The technical bit... it's only needed if you want to learn more!

This is the **circuit diagram**. It shows how all of the components in the circuit are connected. You can compare it to the layout of the components on the actual circuit board (shown below it).

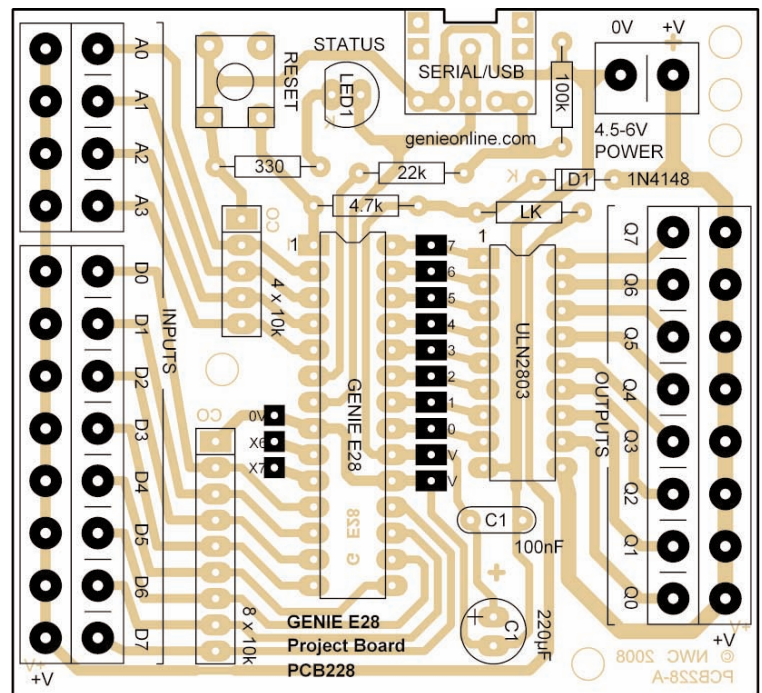
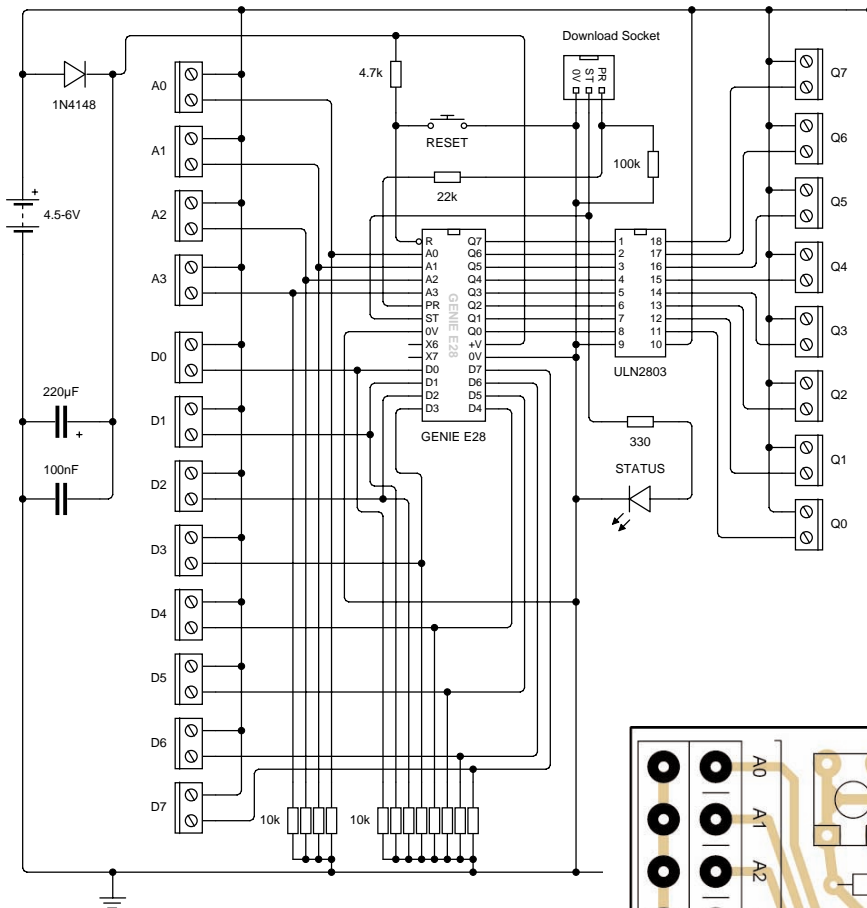





The GENIE E28 Project Board (PCB228) is not available in manufactured form; you should use the artwork masks below to build the board. The mask is also available within Circuit Wizard.

PCB artwork (viewed from component side):

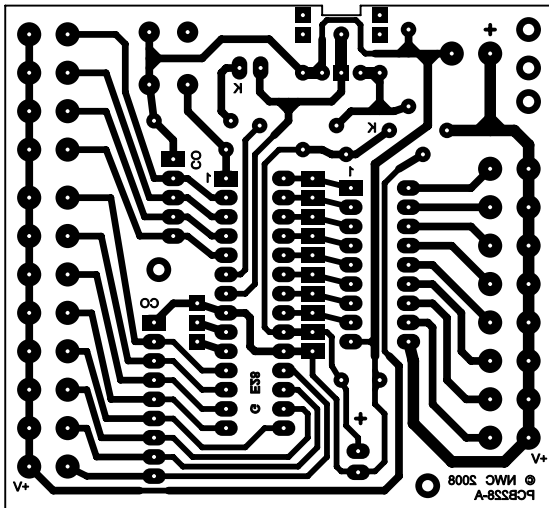

PCB artwork (viewed from copper side):

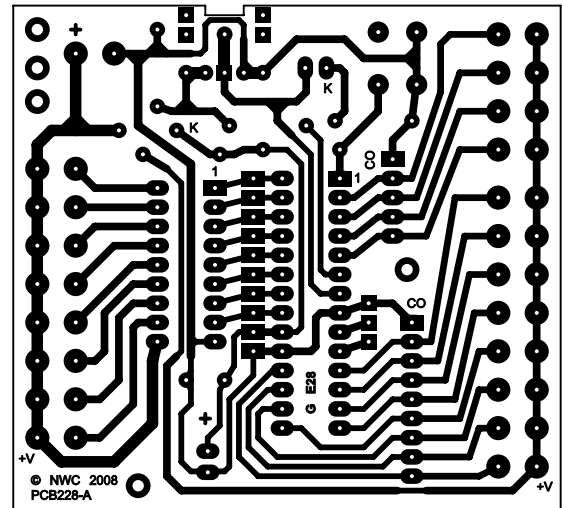

Silk screen (unpopulated) view:

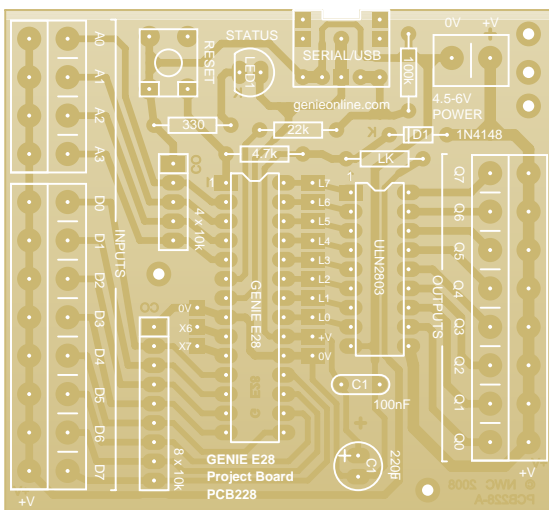

After populating with board with components:

