

**Symbol-Anzeige**  
**Einbau- Ø 10mm**  
**Plan-Kopf Gehäuse**  
**für Rückwandmontage**

**Spezifikation**

FUNKTIONS-ANZEIGE in bis zu 6 Leuchtfarben. Flache, oberflächenmatte Blendenköpfe mit sehr gutem Ein-/Aus-Kontrast.

Diese Serie steht im Niederspannungsbereich mit eingebauten superhellen LEDs zur Verfügung. Für Netzspannungsanwendungen wahlweise auch mit Glühlampen lieferbar. Schnellbefestigung durch Einrastmontage

Werkstoff: PC transparent in Leuchtfarbe

**Einbauöffnung**

Bohrung Ø 10,0+0,2mm

**Anschluss**

- Flachstecker 2,8x0,8mm (Messing blank)
- Litzenanschluss 0,5mm<sup>2</sup> in Standard- und Sonderlängen

**Optionen**

- Gehäuse in klar-transparent
- Sonderspannungen
- LED für 130/230 V

**Stromaufnahme**

- LED bei Nennspannung 6, 12 und 24 V ca. 12 mA
- LED bei Nennspannung 130/230 V AC ca. 2,5 mA
- Glühlampen 130/230 V AC ca. 1,5 mA

**LED indicator**  
**mounting- Ø 10mm**  
**Flat-head housing for**  
**rear panel mounting**

**Specification**

FUNCTION-INDICATOR in up to 6 different colours. Flat, dull surfaced lens heads with magnificent on/off contrast.

Available for low-voltage applications with super bright LEDs. Also available with neon lamps for use in mains voltage applications. Quick and economical snap-in mounting.

Material: PC transparent in emitting colour

**Mounting hole**

Borehole Ø of 10.0+0.2mm

**Connections**

- tab terminal 2.8x0.8mm (brass)
- stranded wires 0.5mm<sup>2</sup> in standard- or special lengths.

**Options**

- clear-transparent housing
- Special voltages
- LED for 130/230 V

**Power consumption**

- LEDs at rated voltages of 6, 12 or 24 V approx. 12 mA
- LEDs at rated voltages of 130/230 V AC about 2,5 mA
- for neon lamps 130/230 V AC approx. 1,5 mA

### Plan-Kopf Gehäuse

Der Frontbereich des Gehäuses entspricht üblichen 5mm Plan-Kopf LEDs. Speziell für den frontbündigen Einbau von der Rückseite geeignet. Der Gehäuse-Grundtyp ist auf 4mm starke Frontplatten abgestimmt. Für Frontplattenstärken von 2 und 3mm werden passende Distanzscheiben mitgeliefert.

### Werkstoff

PC transparent in Leuchtfarbe

### Anschluss

- Litzenanschluss durch Kombination mit LED-Element-Adapter-Serie AN

### Stromaufnahme

Siehe AN-LED-Element-Adapter

### Flat-head housing

The front look of the housing is similar to simple 5mm flat head LEDs. So the planer mounting from the backside is suitable to front side of panel. The basic version of housing is fitted to panels of 4mm thickness. Smaller thicknesses of 2 or 3 mm can be realized with suitable distance disks.

### Material

PC transparent in emitting colour

### Connection

- stranded wires in connection with LED-element adapter series AN

### Power consumption

See AN-LED-element adapter

<b>LED</b>		<i>Optische und Elektrische Daten</i> <i>Optical and electrical characteristics</i>					<i>Grenzdaten</i> <i>Absolut max. ratings</i>			
LED-Typ	Abmessung/Gehäuse Size / Package	Leuchtfarbe Emitting-Colour	Wellenlänge Wavelength	Flussspannung Forward Voltage	Lichtstärke Luminous Intensity	Abstrahlwinkel (Halbwinkel) Angle of half Emission	Durchlassstrom Forward Current	Sperrspannung Reverse Voltage	Verlustleistung Power Dissipation	Betriebstemperatur Operation Temperature
Zeichen / Sign Einheit / Unit Parameter		$\lambda_{Peak}$ nm	$U_F$ typ. V	$I_V$ typ. mcd	$\pm \phi$ °	$I_F$ mA	$U_R$ V	$P_V$ mW	$T_{OP}$ °C	
D5		Rot Red	625	2,0	50	25	30	5	105	-40/+85
		Gelb Yellow	590	2,1	30	25	30	5	105	-40/+85
		Grün Green	565	2,2	30	25	25	5	105	-40/+85

**SKG-H 10**

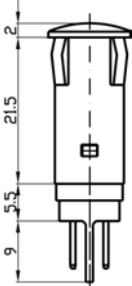

SKI 10

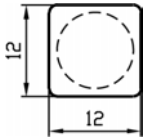

SKH 10

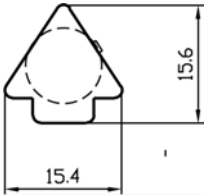

SKJ 10

**SKD 10**

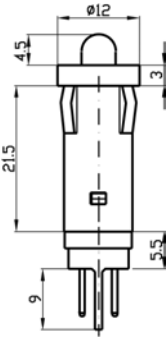



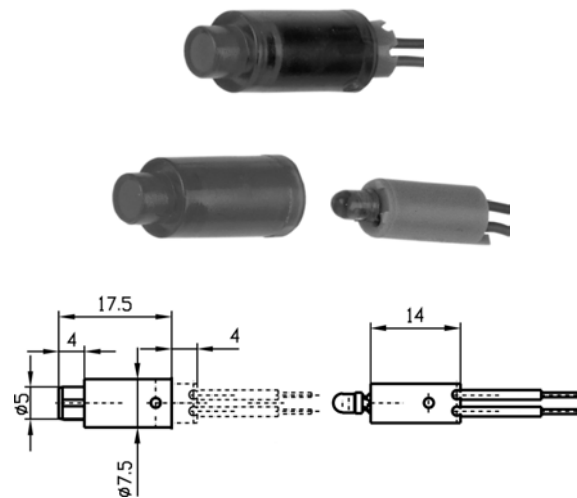



# SKN 07



## Liste der Artikel-Nummern

## List of Part-Numbers

Abbildung figure	Reflektor/Blende Reflector/Lens	LED Typ	Spannung voltage	Rot Red	Gelb Yellow	Grün Green	Ultragrün Ultragreen
	Blendenkopf Rund  round lens head	H5 U5	10 – 14 V	SKGH10022	SKGH10122	SKGH10222	
			20 – 28 V	SKGH10024	SKGH10124	SKGH10224	
			130 V AC	SKGU10027	SKGU10127		SKGU10727
			230 V AC	SKGU10028	SKGU10128		SKGU10728
	Blendenkopf Quadratisch  square lens head	H5	10 – 14 V	SKHH10022	SKHH10122	SKHH10222	
			20 – 28 V	SKHH10024	SKHH10124	SKHH10224	
			130 V AC				
			230 V AC				
	Blendenkopf Pfeil  arrow lens head	D5	10 – 14 V	SKIH10022	SKIH10122	SKIH10222	
			20 – 28 V	SKIH10024	SKIH10124	SKIH10224	
			130 V AC				
			230 V AC				
	Reflektor Schwarz  reflector black	D5	10 – 14 V	SKDD10022	SKDD10122	SKDD10222	
			20 – 28 V	SKDD10024	SKDD10124	SKDD10224	
			130 V AC				
			230 V AC				
	Leegehäuse  Front panel blind	-	Schwarz/Black	SKG 10 9			
	Plan-Kopf- Ø 5mm  Flat top Ø 5mm	-	Rot/Red	SKN 070			
			Gelb/Yellow	SKN 071			
			Grün/Green	SKN 072			
			Orange	SKN 073			
			Blau/Blue	SKN 074			
			Glasklar/Water-clear	SKN 075			

SiCo Artikel-Nr.	Conrad. Art. Nr.
SKIH 10024	150435