

BC846A,B BC847A,B,C BC848A,B,C

0.2 Watts NPN Plastic-Encapsulate Transistors

SOT-23



Features

- ✧ Ideally suited for automatic insertion
- ✧ Epitaxial planar die construction
- ✧ For switching, AF driver and amplifier applications
- ✧ Complementary NPN type available(BC856)
- ✧ Qualified to AEC-Q101 standards for high reliability

Mechanical Data

- ✧ Case: SOT-23, Molded plastic
- ✧ Case material: molded plastic. UL flammability classification rating 94V-0
- ✧ Moisture sensitivity: Level 1 per J-STD-020C
- ✧ Terminals: Solderable per MIL-STD-202, Method 208
- ✧ Lead free plating
- ✧ Marking & Polarity: See diagram
- ✧ Weight: 0.008 gram (approx.)

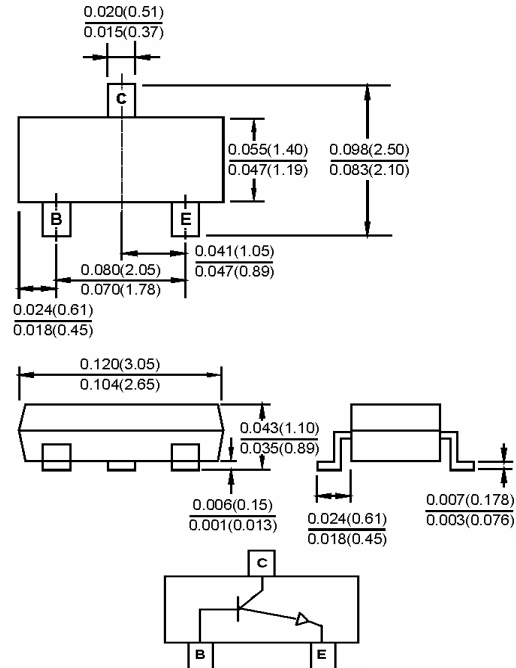

Dimensions in inches and (millimeters)

Maximum Ratings $T_A=25^\circ\text{C}$ unless otherwise specified

Type Number	Symbol	BC846	BC847	BC848	Units
Collector-base breakdown voltage $I_C=10\mu\text{A}, I_E=0$	V_{CBO}	80	50	30	V
Collector-emitter breakdown voltage $I_C=10\text{mA}, I_B=0$	V_{CEO}	65	45	30	V
Collector current	I_{CM}	0.1			A
Power dissipation ($T_{amb}=25^\circ\text{C}$) (Note 1)	P_{CM}	0.2			W
Emitter-base breakdown voltage $I_E=10\mu\text{A}, I_C=0$	V_{EBO}	6			V
Collector cut-off current	I_{CBO}	$V_{CB}=70\text{V}, I_E=0$	0.1	0.1	uA
		$V_{CB}=50\text{V}, I_E=0$	0.1		
		$V_{CB}=30\text{V}, I_E=0$		0.1	
Collector cut-off current	I_{CEO}	$V_{CE}=60\text{V}, I_B=0$	0.1	0.1	uA
		$V_{CE}=45\text{V}, I_B=0$			
		$V_{CE}=30\text{V}, I_B=0$	0.1		
Emitter cut-off current $V_{EB}=5\text{V}, I_C=0$	I_{EBO}	0.1			uA
Collector-emitter saturation voltage $I_C=100\text{mA}, I_B=5\text{mA}$	$V_{CE}(\text{sat})$	0.5			V
Base-emitter saturation voltage $I_C=100\text{mA}, I_B=5\text{mA}$	$V_{BE}(\text{sat})$	1.1			V
Base-emitter voltage	V_{BE}	$V_{CE}=5\text{V}, I_C=2\text{mA}$	700		mV
		$V_{CE}=5\text{V}, I_C=10\text{mA}$	770		
Transition frequency $V_{CE}=5\text{V}, I_C=10\text{mA}, f=100\text{MHz}$	f_T	100			MHz
Operating and Storage Temperature Range	T_J, T_{STG}	-55 to +150			$^\circ\text{C}$
Type Number	Symbol	Min	Max	Units	
DC current gain BC846A,847A,848A BC846B,847B,848B $V_{CE}=5\text{V}, I_C=2\text{mA}$ BC847C / BC848C	$H_{FE(1)}$	110	220		
		200	450		
		420	800		

DEVICE MARKING

BC846A=1A, BC846B=1B, BC847A=1E, BC847B=1F, BC847C=1G, BC848A=1J, BC848B=1K, BC848C=1L

Note 1: Transistor mounted on an FR4 Printed-circuit board.

RATINGS AND CHARACTERISTIC CURVES (BC846A, B ; BC847A, B, C ; BC848A, B, C)

FIG.1- NORMALIZED DC CURRENT GAIN

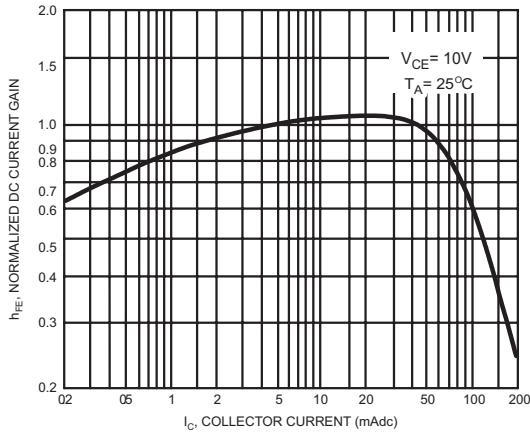

FIG.2- "SATURATION" AND "ON" VOLTAGES

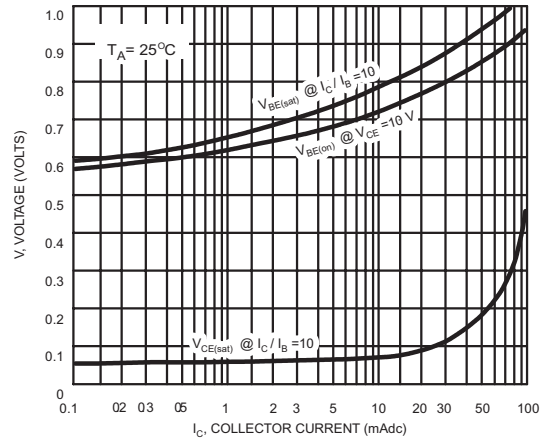

FIG.3- COLLECTOR SATURATION REGION

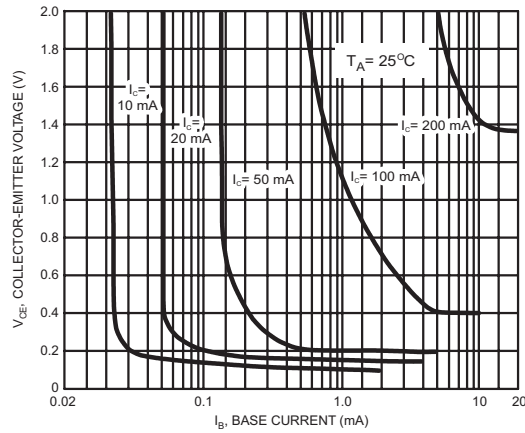

FIG.4- BASE-EMITTER TEMPERATURE COEFFICIENT

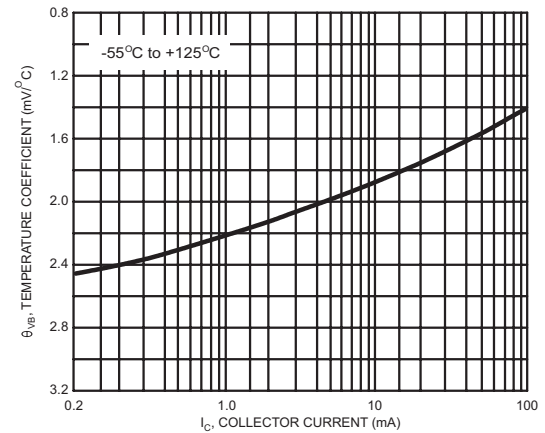

FIG.5- CAPACITANCES

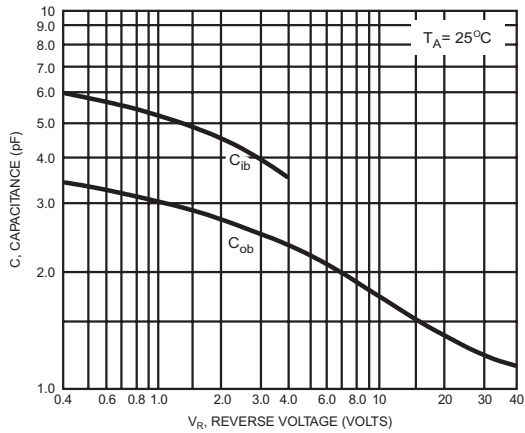
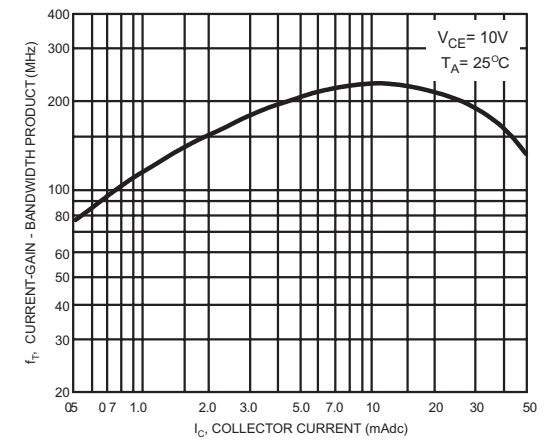

FIG.6- CURRENT-GAIN - BANDWIDTH PRODUCT



RATINGS AND CHARACTERISTIC CURVES (BC846A, B ; BC847A, B, C ; BC848A, B, C)

FIG.7- DC CURRENT GAIN

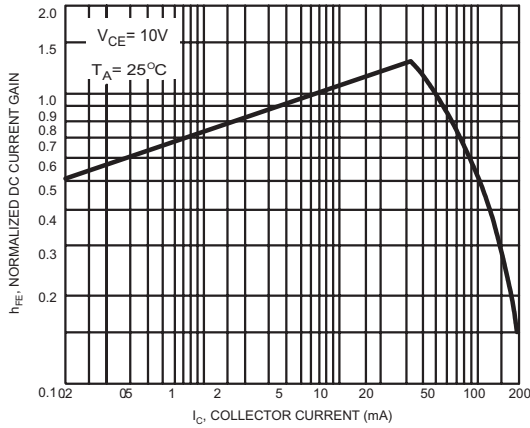

FIG.8- "ON" VOLTAGES

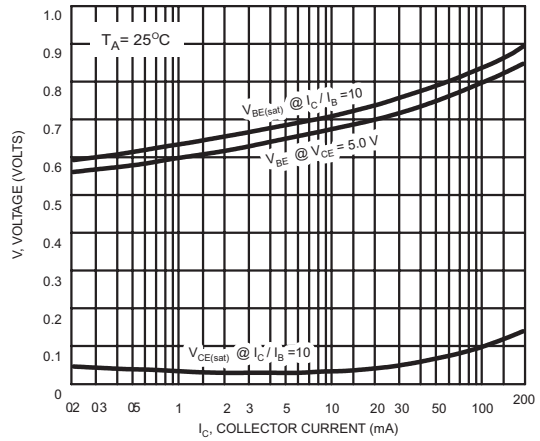

FIG.9- COLLECTOR SATURATION REGION

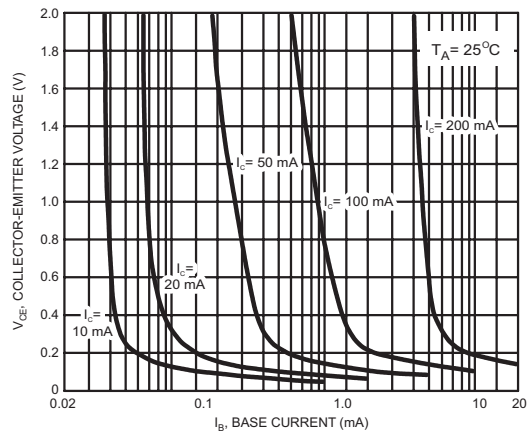

FIG.10- BASE-EMITTER TEMPERATURE COEFFICIENT

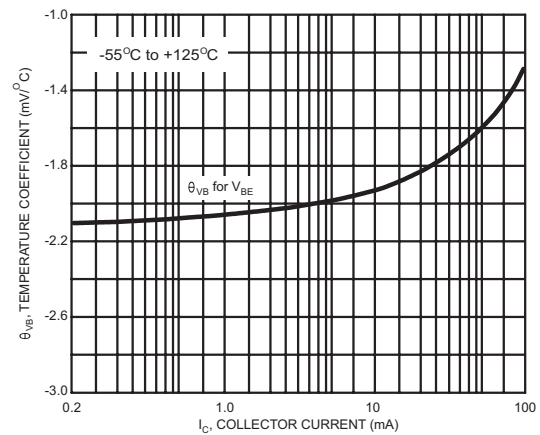

FIG.11- CAPACITANCES

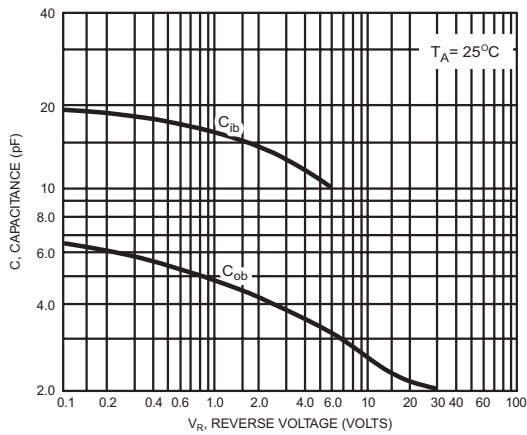

FIG.12- CURRENT-GAIN - BANDWIDTH PRODUCT

