

# Features

## Regulated Converters

- SMD Constant Current LED Driver
- Built-in Class A or Class B EMC Filter
- Wide Input and Output Voltage Range
- Digital PWM and Analogue Voltage Dimming
- Short Circuit and Overtemperature Protected
- Low Cost
- 96% Efficiency
- 5 Year Warranty

### Description

The RCD-24-xxx/PL series is a step-down constant current source designed for driving high power LEDs. The converter uses a pinless SMD open frame design to reduce cost and size. Output currents available are 300mA, 350mA, 500mA, 600mA and 700mA with either Class A (Suffix /A) or Class B (suffix /B) built-in EMC filtering. Despite its compact size, the RCD-PL series is fully featured with very high efficiency, wide input voltage range, high ambient operating temperature and two means of LED dimming: PWM/digital control and analogue voltage dimming. Both dimming controls are independent and can be combined. The driver is also designed to be as reliable as the LEDs it is driving, even at the full ambient operating temperature and is designed for strip lighting, wall washers and fluorescent tube replacement designs, where a low profile and narrow width are demanded.

### Selection Guide

Part Number	Input Range (VDC)	Output Current (mA)	Output Voltage (Vmin-Vmax)	Dimming Control	Mounting Style
RCD-24-0.30/PL*	4.5-36V	0-300	2-35	Digital + Analogue	Pinless SMD
RCD-24-0.35/PL*	4.5-36V	0-350	2-35	Digital + Analogue	Pinless SMD
RCD-24-0.50/PL*	4.5-36V	0-500	2-35	Digital + Analogue	Pinless SMD
RCD-24-0.60/PL*	4.5-36V	0-600	2-35	Digital + Analogue	Pinless SMD
RCD-24-0.70/PL*	4.5-36V	0-700	2-35	Digital + Analogue	Pinless SMD

\* /A is EMC Class A input Filter

Add -R for Tape and Reel Packaging.g. RCD-24-0.35/PL/B-R

\* /B for EMC Class B input Filter

### Specifications

( typical at 25°C, nominal input voltage, rated output current unless otherwise specified )

Input Voltage (absolute maximum)	40VDC max	
Recommended Input Voltage	6V min. / 24V typ. / 36VDC max	
Input Filter	Suffix /A Suffix /B	Capacitor Common Mode Choke + Pi Filter
Output Current Accuracy	Vin=24V	±2% typ, ±3% max
Internal Power Dissipation	Worst case load of 5 LEDs	800mW max
Output Current Stability	Vin=36V, Vout =1-9 LEDs	±1% max
Output Ripple and Noise (20MHz BW)	Vin=36V, Vout =1-9 LEDs	300mVp-p max
Temperature Coefficient	-40°C~+85°C ambient	±0.015%/°C max
Maximum Capacitive Load	100µF	
Operating Frequency	212kHz min/ 250kHz typ/ 280kHz max	
Efficiency at Full Load	96% typ	
Short Circuit Protection	Regulated at rated output current	
Operating Temperature Range	300/350mA	-40°C to +85°C
	500mA	-40°C to +80°C
	600/700mA	-40°C to +75°C
Storage Temperature Range	-55°C to +125°C	
Relative Humidity	5% to 95% RH, non-condensing	
Dimensions	31.0 x 11.4 x 6.6mm	
Weight	1.9g	
Packing Quantity	12 pcs per Tube / 400 pcs per Reel	
Reflow Soldering Profile	265°C/10 secs max.	
MTBF	25°C	>600 hours
(using MIL HDBK 217F)	75°C	>500 hours

continued on next page

# LIGHTLINE

## DC/DC-Converter

with 5 year Warranty



## Constant Current LED Driver



EN-60950-1 Certified

# RCD-24-PL

## Derating Graph

(Ambient Temperature)

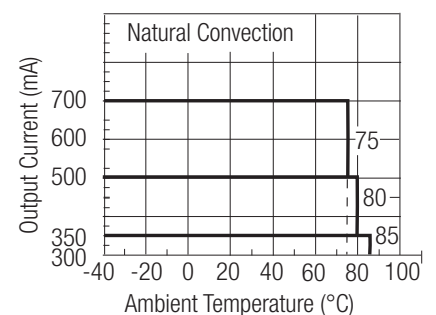

**Specifications -Continued**

**PWM Dimming and ON/OFF Control** (Leave open if not used)

Remote ON/OFF	DC/DC ON	Open or $0V < V_r < 0.6V$
Threshold Voltages	DC/DC OFF (Standby)	$0.6 < V_r < 2.9V$
	DC/DC OFF (Full Shutdown)	$2.9V < V_r < 6V$
Remote Pin Drive Current	$V_r = 5V$	1mA max
Quiescent Input Current in Shutdown Mode	$V_{in} = 36V$	200µA max
Recommended PWM Frequency (measured 10%~90% Dimming)	For Linear Operation	20 -200Hz
	Maximum Frequency	2000Hz

**Analogue Dimming Control** (leave open if not used)

Input Voltage Range		-0.3V - 15V
Control Voltage Range Limits (see Graph)	Full On	$0.13V \pm 50mV$
	Full Off	$4.5V \pm 200mV$
Analogue Pin Drive Current	$V_c = 5V$	0.2mA max.

**Environmental**

Conducted Emissions	(/A Suffix)	EN55022	Class A
	(/B Suffix)	EN55022	Class B
Radiated Emissions	(all series)	EN55022	Class B
ESD	(all series)	EN61000-4-2	Class A
Radiated Immunity	(all series)	EN61000-4-3	Class A
Fast Transient	(all series)	EN61000-4-4	Class A
Conducted Immunity	(all series)	EN61000-4-6	Class A

**Digital Dimming**

PWM Digital Control Signal

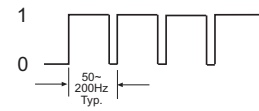

Output Current (LED appears dim)



PWM Digital Control Signal

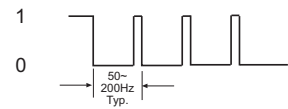

Output Current (LED appears bright)



**Analogue Dimming**

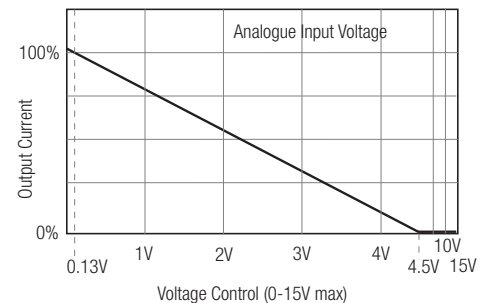

**Typical Characteristics**

$V_{in} = 24V, I_{out} = 300\sim 700mA$

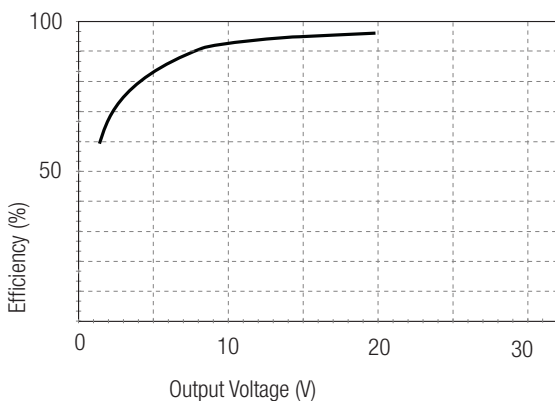

$V_{in} = 32V, I_{out} = 300\sim 700mA$

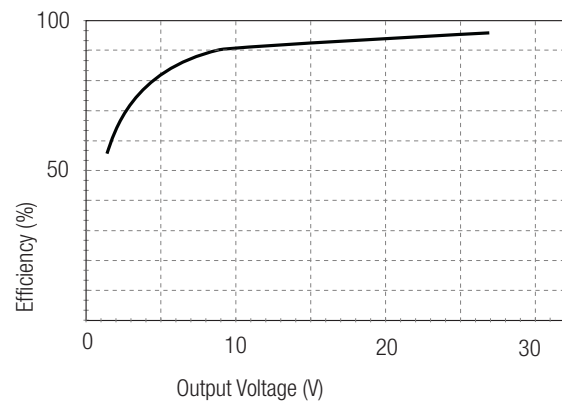

Package Style and Pinning

Class A Version

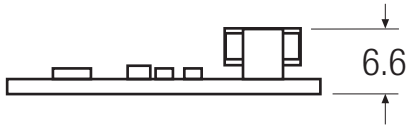

Class B Version

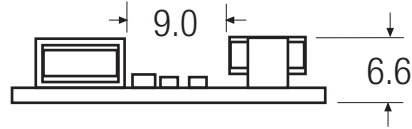

3rd angle projection

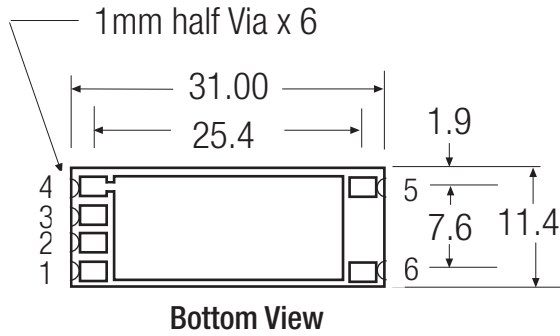

Bottom View

PCB Layout Top View

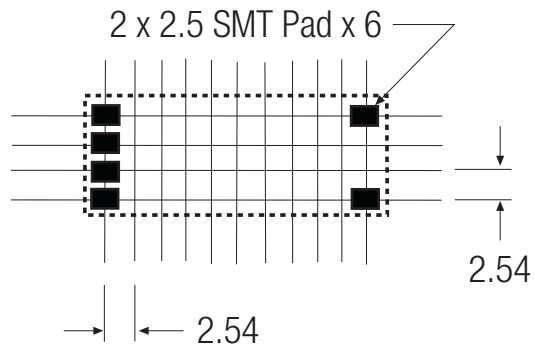

Pad Connections		RCD-24-PL Series
Pad #	Out	Comments
1	+Vin	DC Supply
2	Analogue Dimming	Leave open if not used
3	PWM/ON/OFF	Leave open if not used
4	GND	Do not connect to -Vout
5	-Vout	LED Cathode Connection
6	+Vout	LED Anode Connection

XX.X ± 0.5 mm  
XX.XX ± 0.25 mm