

International IOR Rectifier

10TQ... 10TQ...S

SCHOTTKY RECTIFIER

10 Amp

$$I_{F(AV)} = 10\text{Amp}$$

$$V_R = 35 - 45\text{V}$$

Major Ratings and Characteristics



Characteristics	Values	Units
$I_{F(AV)}$ Rectangular waveform	10	A
V_{RRM}	35 - 45	V
I_{FSM} @tp = 5 μ s sine	1050	A
V_F @10 Apk, $T_J = 125^\circ\text{C}$	0.49	V
T_J range	-55 to 175	$^\circ\text{C}$

Description/ Features

The 10TQ.. Schottky rectifier series has been optimized for low reverse leakage at high temperature. The proprietary barrier technology allows for reliable operation up to 175° C junction temperature. Typical applications are in switching power supplies, converters, free-wheeling diodes, and reverse battery protection.

- 175° C T_J operation
- High purity, high temperature epoxy encapsulation for enhanced mechanical strength and moisture resistance
- Low forward voltage drop
- High frequency operation
- Guard ring for enhanced ruggedness and long term reliability

Case Styles

10TQ...	10TQ... S
 <p>TO-220</p>	 <p>D²PAK</p>

Voltage Ratings

Part number	10TQ035	10TQ045
V_R Max. DC Reverse Voltage (V)	35	45
V_{RWM} Max. Working Peak Reverse Voltage (V)		

Absolute Maximum Ratings

Parameters	10TQ	Units	Conditions
$I_{F(AV)}$ Max. Average Forward Current * See Fig. 5	10	A	50% duty cycle @ $T_C = 151^\circ\text{C}$, rectangular wave form
I_{FSM} Max. Peak One Cycle Non-Repetitive Surge Current * See Fig. 7	1050	A	Following any rated load condition and with rated V_{RWM} applied
	280		
E_{AS} Non-Repetitive Avalanche Energy	13	mJ	$T_J = 25^\circ\text{C}$, $I_{AS} = 2\text{Amps}$, $L = 6.5\text{mH}$
I_{AR} Repetitive Avalanche Current	2	A	Current decaying linearly to zero in $1\mu\text{sec}$ Frequency limited by T_J max. $V_A = 1.5 \times V_R$ typical

Electrical Specifications

Parameters	10TQ	Units	Conditions
V_{FM} Max. Forward Voltage Drop (1) * See Fig. 1	0.57	V	@ 10A $T_J = 25^\circ\text{C}$
	0.67	V	@ 20A
	0.49	V	@ 10A $T_J = 125^\circ\text{C}$
	0.61	V	@ 20A
I_{RM} Max. Reverse Leakage Current (1) * See Fig. 2	2	mA	$T_J = 25^\circ\text{C}$
	15	mA	$T_J = 125^\circ\text{C}$ $V_R = \text{rated } V_R$
C_T Max. Junction Capacitance	900	pF	$V_R = 5V_{DC}$ (test signal range 100Khz to 1Mhz) 25°C
L_S Typical Series Inductance	8.0	nH	Measured lead to lead 5mm from package body
dv/dt Max. Voltage Rate of Change	10000	V/ μs	(Rated V_R)

(1) Pulse Width < 300 μs , Duty Cycle < 2%

Thermal-Mechanical Specifications

Parameters	10TQ	Units	Conditions
T_J Max. Junction Temperature Range	-55 to 175	$^\circ\text{C}$	
T_{stg} Max. Storage Temperature Range	-55 to 175	$^\circ\text{C}$	
R_{thJC} Max. Thermal Resistance Junction to Case	2.0	$^\circ\text{C/W}$	DC operation * See Fig. 4
R_{thCS} Typical Thermal Resistance, Case to Heatsink	0.50	$^\circ\text{C/W}$	Mounting surface, smooth and greased
wt Approximate Weight	2(0.07)	g(oz.)	
T Mounting Torque	Min. 6(5)	Kg-cm (lbf-in)	
	Max. 12(10)		
Marking Device	10TQ045	Case Style TO-220	
	10TQ045S	Case Style D ² Pak	

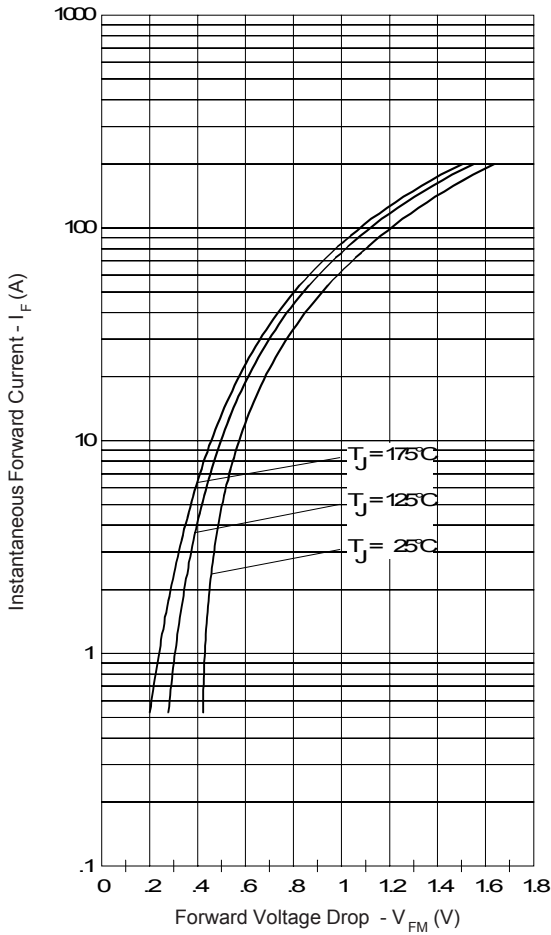

Fig. 1 - Maximum Forward Voltage Drop Characteristics

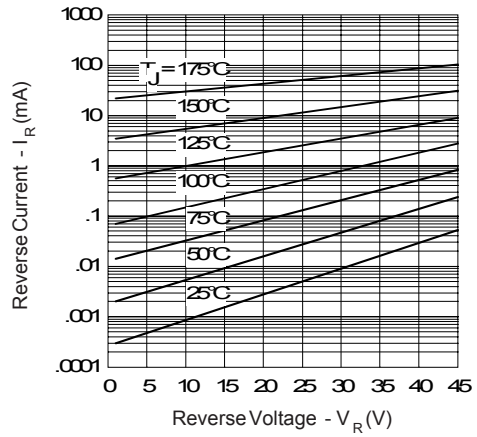

Fig. 2 - Typical Values of Reverse Current Vs. Reverse Voltage

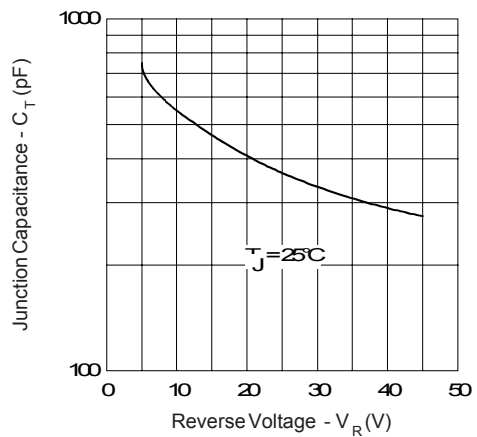

Fig. 3 - Typical Junction Capacitance Vs. Reverse Voltage

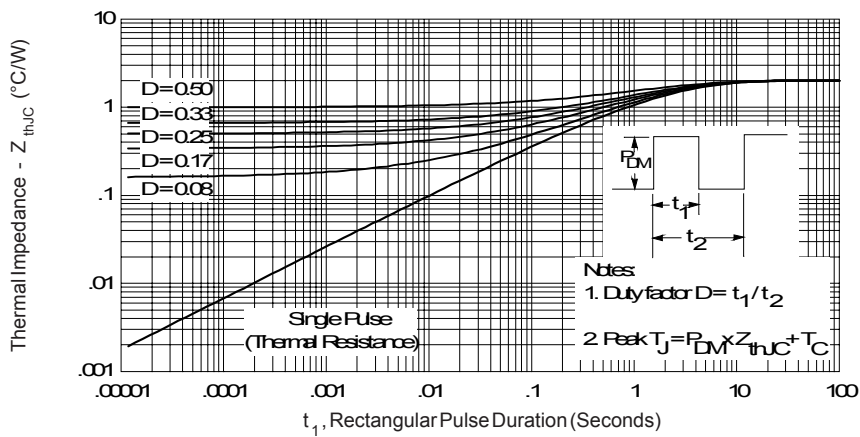

Fig. 4 - Maximum Thermal Impedance Z_{thJC} Characteristics

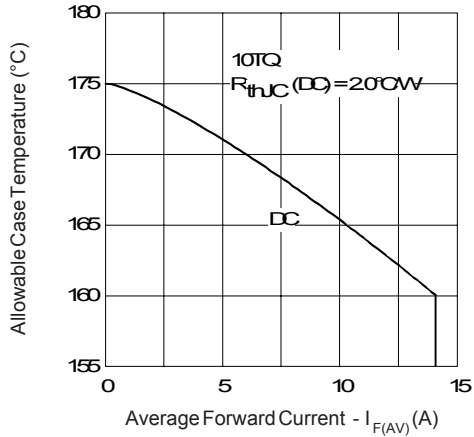

Fig. 5 - Maximum Allowable Case Temperature Vs. Average Forward Current

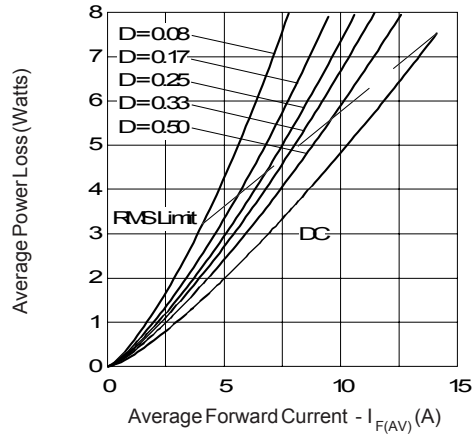

Fig. 6 - Forward Power Loss Characteristics

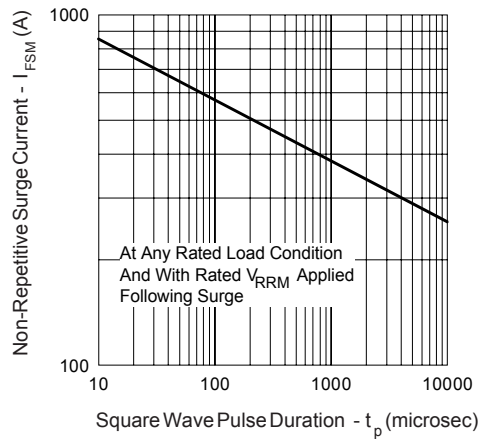

Fig. 7 - Maximum Non-Repetitive Surge Current

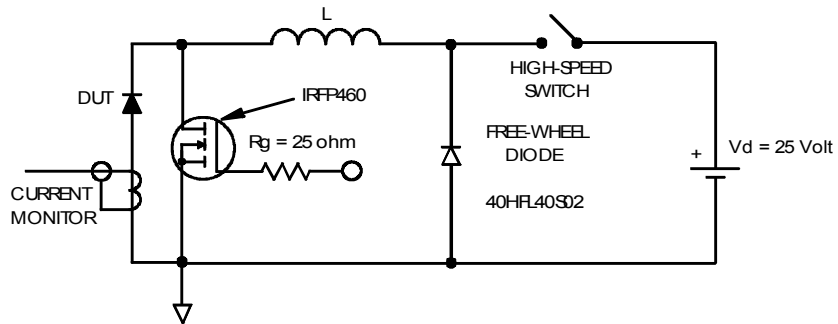
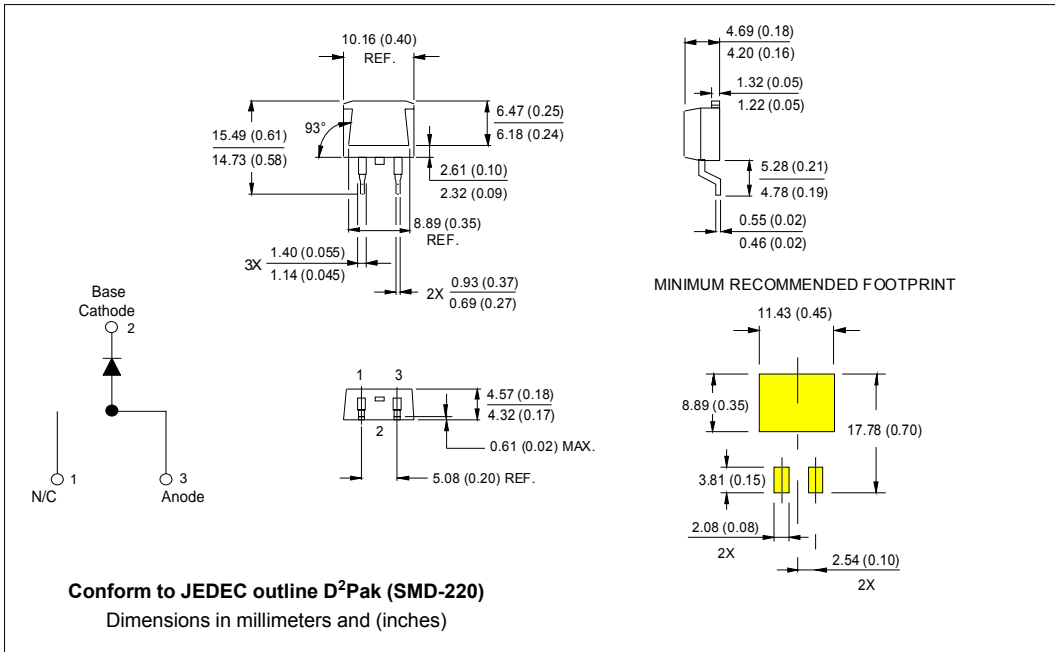
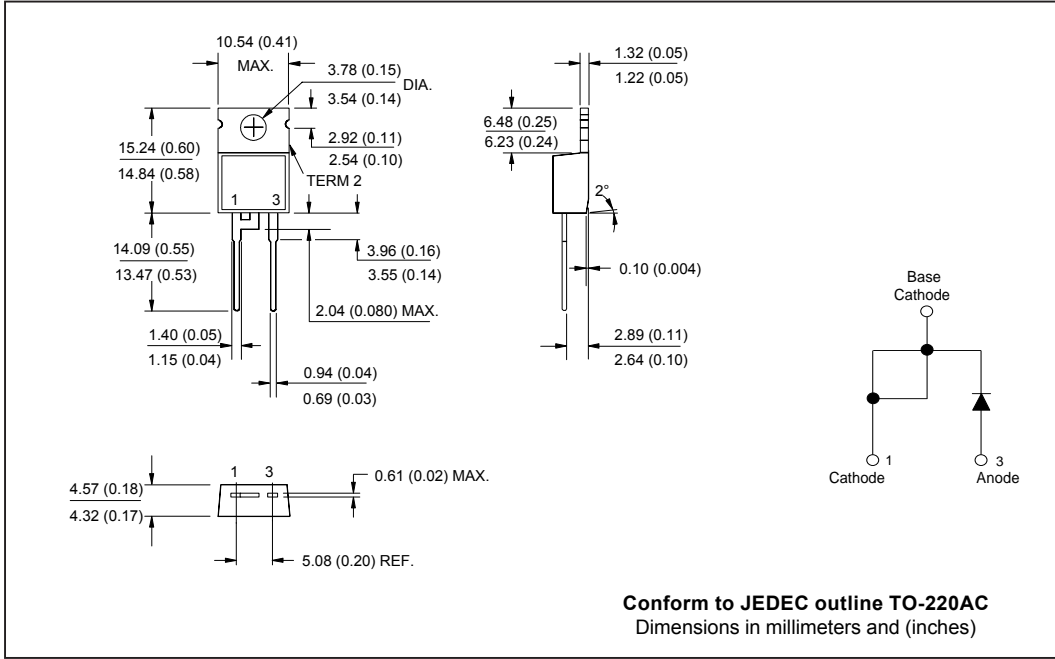
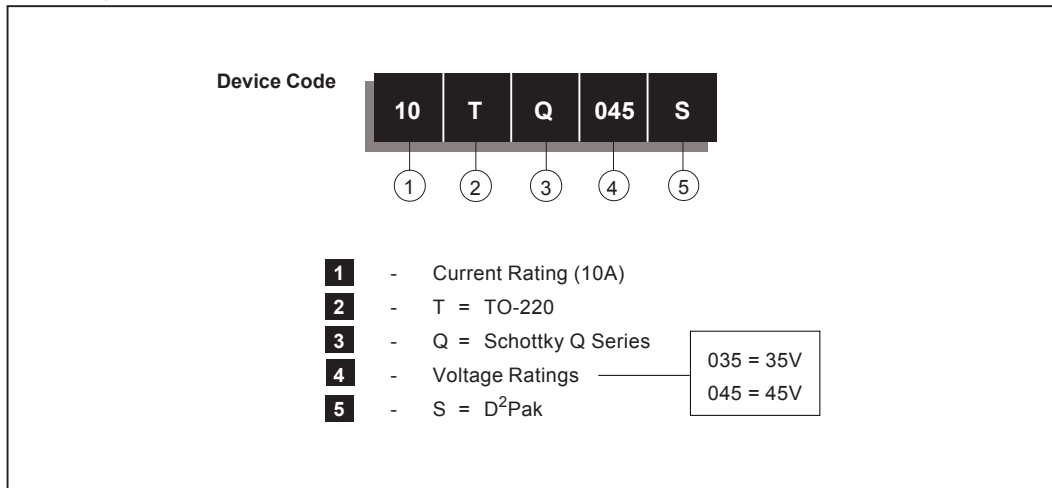

Fig. 8 - Unclamped Inductive Test Circuit

Outline Table



Ordering Information Table



Data and specifications subject to change without notice.
This product has been designed and qualified for Industrial Level.
Qualification Standards can be found on IR's Web site.