

# International IR Rectifier

## 20CTQ... 20CTQ...S 20CTQ... -1

SCHOTTKY RECTIFIER

20 Amp

$I_{F(AV)} = 20\text{Amp}$   
 $V_R = 35 \text{ to } 45\text{V}$

### Major Ratings and Characteristics

Characteristics	20CTQ	Units
$I_{F(AV)}$ Rectangular waveform	20	A
$V_{RRM}$ range	35 to 45	V
$I_{FSM}$ @ $t_p = 5 \mu\text{s}$ sine	1060	A
$V_F$ @ $10\text{Apk}$ , $T_J = 125^\circ\text{C}$ (per leg)	0.57	V
$T_J$ range	-55 to 175	$^\circ\text{C}$

### Description/Features

The 20CTQ center tap Schottky rectifier series has been optimized for low reverse leakage at high temperature. The proprietary barrier technology allows for reliable operation up to  $175^\circ\text{C}$  junction temperature. Typical applications are in switching power supplies, converters, free-wheeling diodes, and reverse battery protection.

- $175^\circ\text{C}$   $T_J$  operation
- Center tap TO-220 package
- Low forward voltage drop
- High purity, high temperature epoxy encapsulation for enhanced mechanical strength and moisture resistance
- High frequency operation
- Guard ring for enhanced ruggedness and long term reliability

### Case Styles

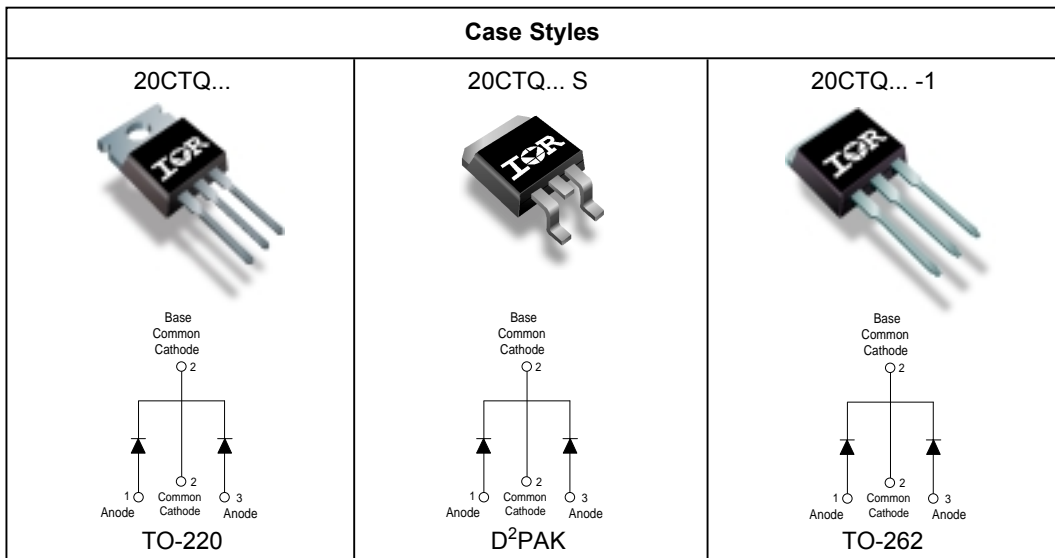

## Voltage Ratings

Part number	20CTQ035	20CTQ040	20CTQ045
$V_R$ Max. DC Reverse Voltage (V)	35	40	45
$V_{RWM}$ Max. Working Peak Reverse Voltage (V)			

## Absolute Maximum Ratings

Parameters	20CTQ	Units	Conditions
$I_{F(AV)}$ Max. Average Forward Current * See Fig. 5	20	A	50% duty cycle @ $T_C = 145^\circ\text{C}$ , rectangular wave form
$I_{FSM}$ Max. Peak One Cycle Non-Repetitive Surge Current (Per Leg) * See Fig. 7	1060	A	Following any rated load condition and with rated $V_{RRM}$ applied
	265		
$E_{AS}$ Non-Repetitive Avalanche Energy (Per Leg)	13	mJ	$T_J = 25^\circ\text{C}$ , $I_{AS} = 2.0$ Amps, $L = 6.5$ mH
$I_{AR}$ Repetitive Avalanche Current (Per Leg)	2.0	A	Current decaying linearly to zero in 1 $\mu\text{sec}$ Frequency limited by $T_J$ max. $V_A = 1.5 \times V_R$ typical

## Electrical Specifications

Parameters	20CTQ	Units	Conditions
$V_{FM}$ Max. Forward Voltage Drop (Per Leg) * See Fig. 1 (1)	0.64	V	@ 10A
	0.76	V	@ 20A
	0.57	V	@ 10A
	0.68	V	@ 20A
$I_{RM}$ Max. Reverse Leakage Current (Per Leg) * See Fig. 2 (1)	2	mA	$T_J = 25^\circ\text{C}$
	15	mA	$T_J = 125^\circ\text{C}$
$C_T$ Max. Junction Capacitance (Per Leg)	900	pF	$V_R = 5V_{DC}$ , (test signal range 100Khz to 1Mhz) $25^\circ\text{C}$
$L_S$ Typical Series Inductance (Per Leg)	8.0	nH	Measured lead to lead 5mm from package body
$dv/dt$ Max. Voltage Rate of Change (Rated $V_R$ )	10000	V/ $\mu\text{s}$	

(1) Pulse Width < 300 $\mu\text{s}$ , Duty Cycle <2%

## Thermal-Mechanical Specifications

Parameters	20CTQ	Units	Conditions
$T_J$ Max. Junction Temperature Range	-55 to 175	$^\circ\text{C}$	
$T_{stg}$ Max. Storage Temperature Range	-55 to 175	$^\circ\text{C}$	
$R_{thJC}$ Max. Thermal Resistance Junction to Case (Per Leg)	3.25	$^\circ\text{C}/\text{W}$	DC operation * See Fig. 4
$R_{thJC}$ Max. Thermal Resistance Junction to Case (Per Package)	1.63	$^\circ\text{C}/\text{W}$	DC operation
$R_{thCS}$ Typical Thermal Resistance, Case to Heatsink	0.50	$^\circ\text{C}/\text{W}$	Mounting surface, smooth and greased
wt Approximate Weight	2 (0.07)	g (oz.)	
T Mounting Torque	Min. 6 (5)	Kg-cm (lbf-in)	
	Max. 12 (10)		

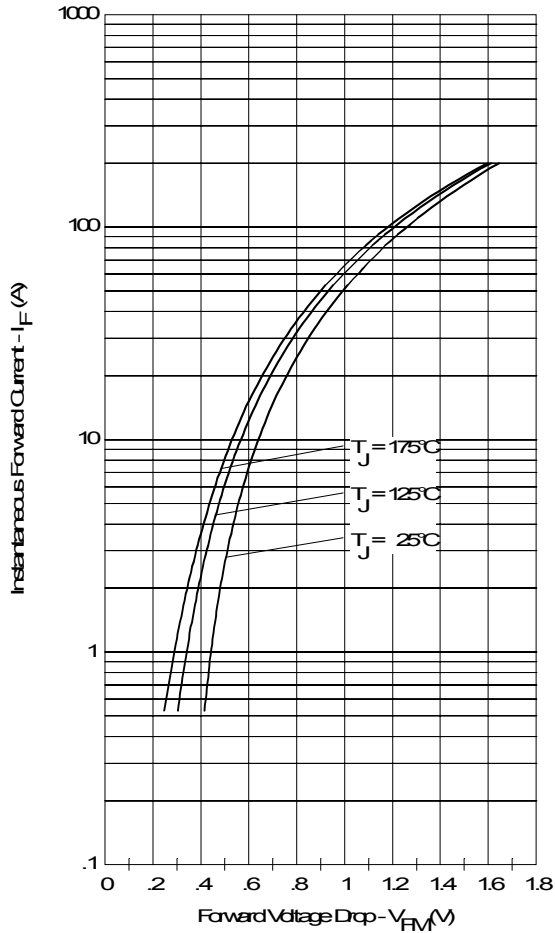

Fig. 1 - Max. Forward Voltage Drop Characteristics (Per Leg)

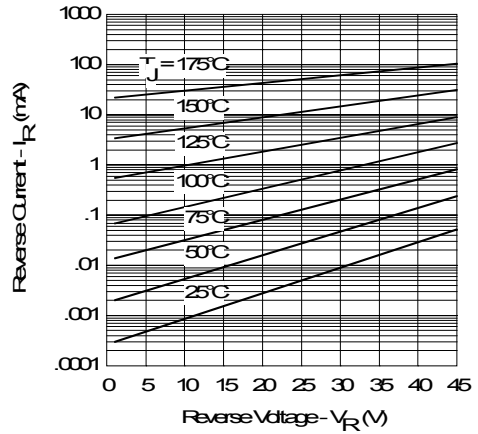

Fig. 2 - Typical Values Of Reverse Current Vs. Reverse Voltage (Per Leg)

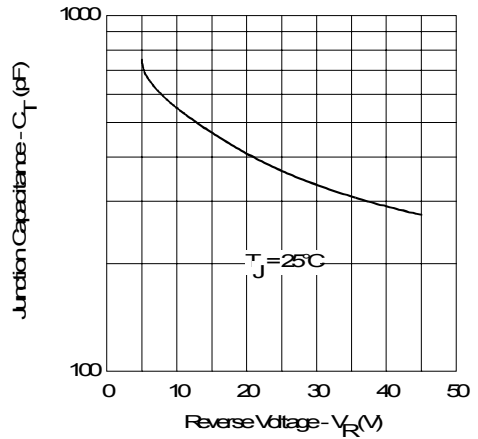

Fig. 3 - Typical Junction Capacitance Vs. Reverse Voltage (Per Leg)

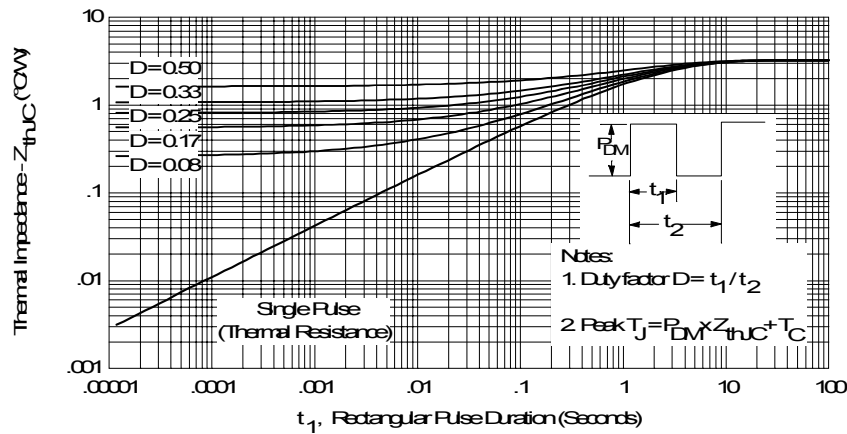

Fig. 4 - Max. Thermal Impedance  $Z_{thJC}$  Characteristics (Per Leg)

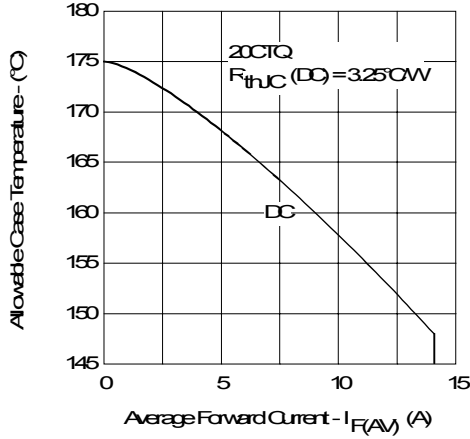

Fig. 5 - Max. Allowable Case Temperature Vs. Average Forward Current (Per Leg)

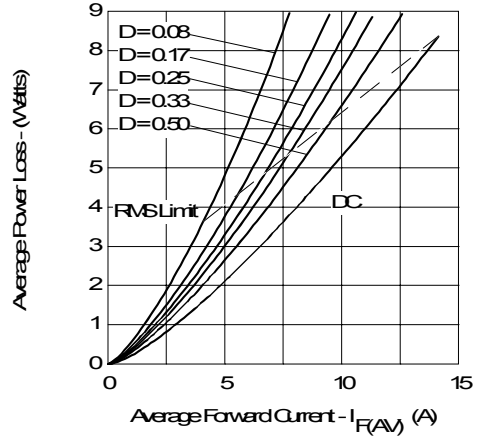

Fig. 6 - Forward Power Loss Characteristics (Per Leg)

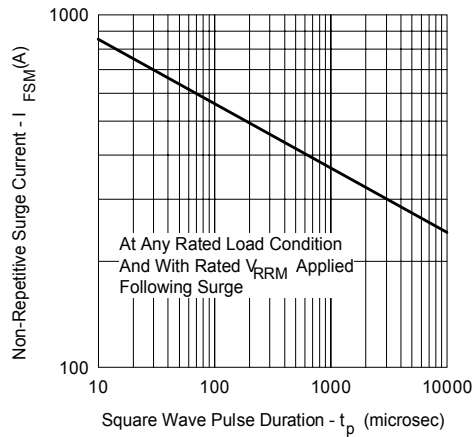

Fig. 7 - Max. Non-Repetitive Surge Current (Per Leg)

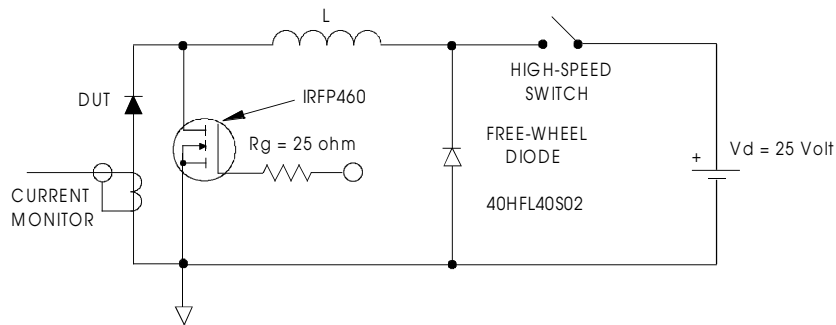
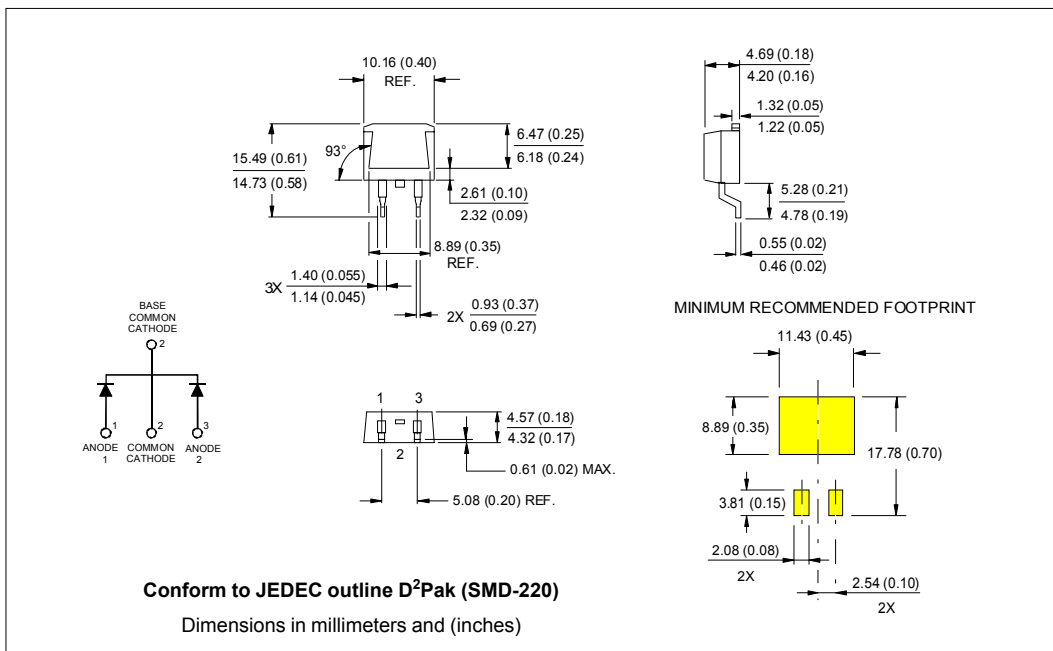
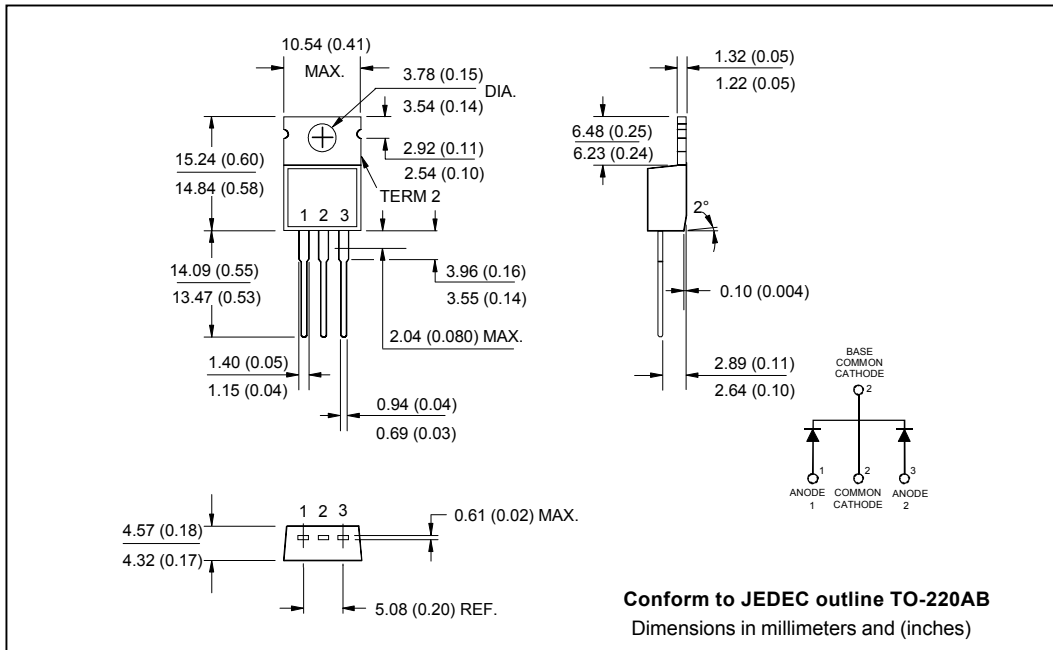
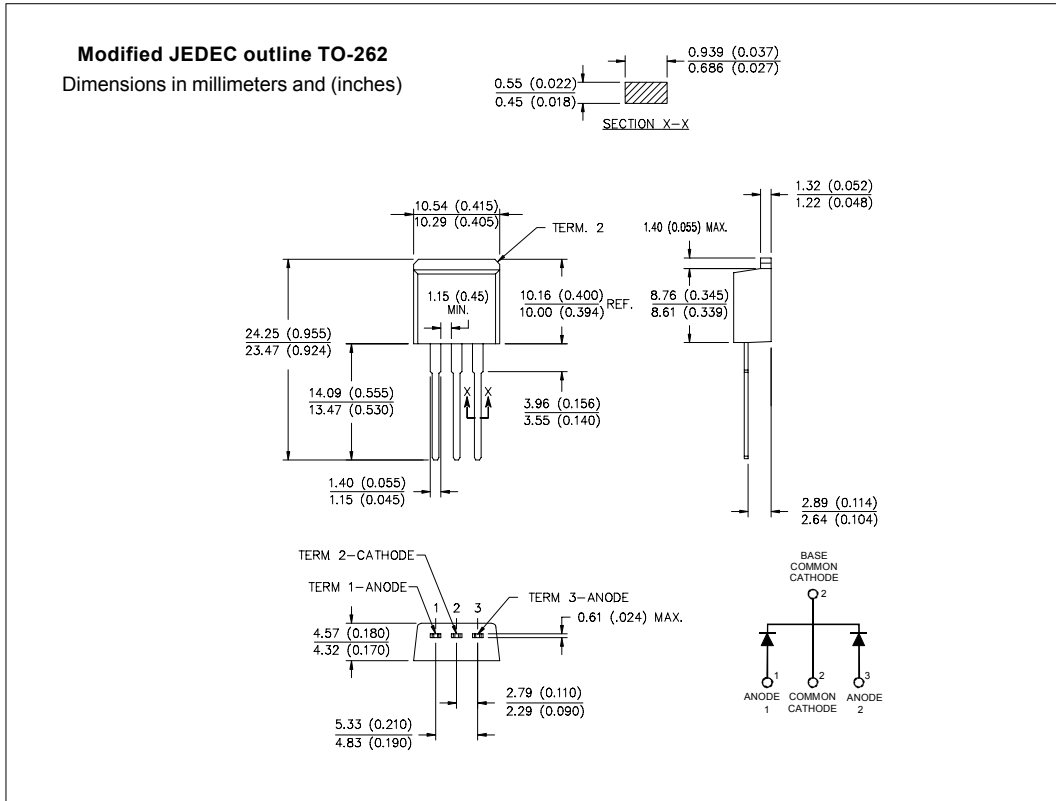

Fig. 8 - Unclamped Inductive Test Circuit

Outline Table



Outline Table



Marking Information

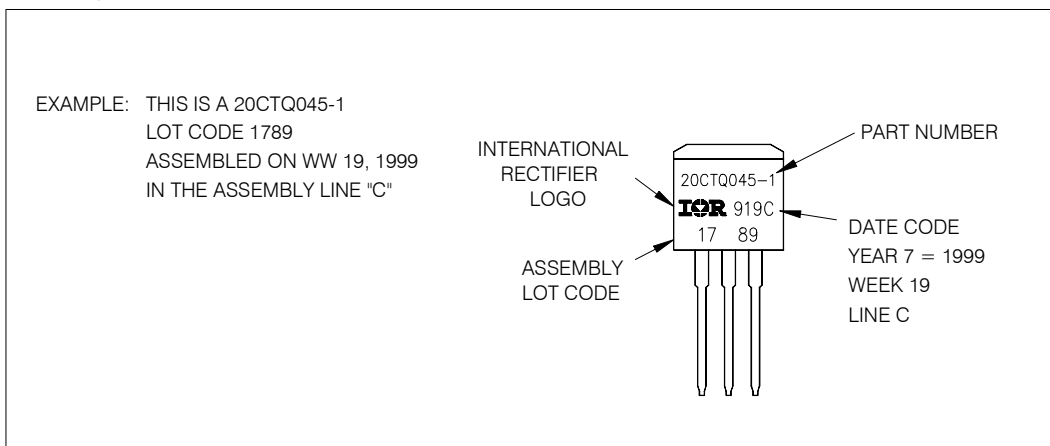

Tape & Reel Information

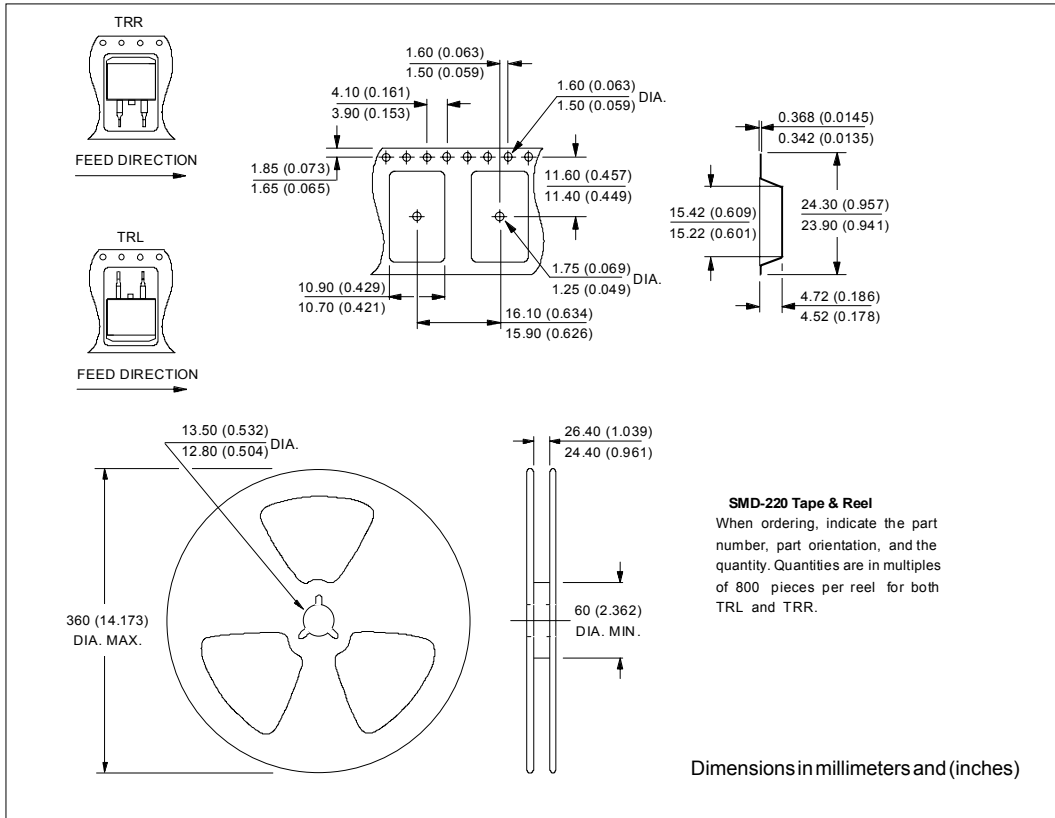

Ordering Information Table

Device Code					
<b>20</b>	<b>C</b>	<b>T</b>	<b>Q</b>	<b>045</b>	<b>-1</b>
①	②	③	④	⑤	⑥
<b>1</b>	- Essential Part Number				
<b>2</b>	- Common Cathode				
<b>3</b>	- T = TO-220				
<b>4</b>	- Q = Schottky Q Series				
<b>5</b>	- Voltage Rating				
<b>6</b>	- S = D <sup>2</sup> Pak				
	- -1 = TO-262				

035 = 35V
040 = 40V
045 = 45V

## 20CTQ... Series

Bulletin PD-20056 rev. A 12/01

International  
**IOR** Rectifier

---

Data and specifications subject to change without notice.  
This product has been designed and qualified for Industrial Level.  
Qualification Standards can be found on IR's Web site.

International  
**IOR** Rectifier

**IR WORLD HEADQUARTERS:** 233 Kansas St., El Segundo, California 90245, USA Tel: (310) 252-7105

TAC Fax: (310) 252-7309

Visit us at [www.irf.com](http://www.irf.com) for sales contact information. 12/01