



MBR15..CT
MBRB15..CT
MBR15..CT-1

SCHOTTKY RECTIFIER

15 Amp





Major Ratings and Characteristics

Characteristics	MBR15..CT	Units
$I_{F(AV)}$ Rectangular waveform	15	A
V_{RRM}	35/45	V
I_{FSM} @ tp = 5 μ s sine	690	A
V_F @ 7.5 Apk, $T_J = 125^\circ\text{C}$	0.57	V
T_J	-65 to 150	$^\circ\text{C}$

Description/ Features

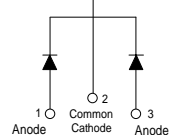
The MBR15..CT center tap Schottky rectifier has been optimized for low reverse leakage at high temperature. The proprietary barrier technology allows for reliable operation up to 150° C junction temperature. Typical applications are in switching power supplies, converters, free-wheeling diodes, and reverse battery protection.

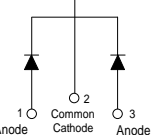
- 150° C T_J operation
- Center tap TO-220 package
- Low forward voltage drop
- High purity, high temperature epoxy encapsulation for enhanced mechanical strength and moisture resistance
- High frequency operation
- Guard ring for enhanced ruggedness and long term reliability

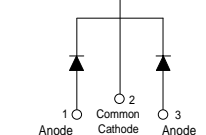
Case Styles		
<p>MBR15..CT</p>  <p>Base Common Cathode 2</p>  <p>1 Anode 2 Common Cathode 3 Anode</p> <p>TO-220</p>	<p>MBRB15..CT</p>  <p>Base Common Cathode 2</p>  <p>1 Anode 2 Common Cathode 3 Anode</p> <p>D²PAK</p>	<p>MBR15..CT-1</p>  <p>Base Common Cathode 2</p>  <p>1 Anode 2 Common Cathode 3 Anode</p> <p>TO-262</p>

Voltage Ratings

Parameters	MBR1535CT MBRB1535CT MBR1535CT-1	MBR1545CT MBRB1545CT MBR1545CT-1
V _R Max. DC Reverse Voltage (V)	35	45
V _{RWM} Max. Working Peak Reverse Voltage (V)		

Absolute Maximum Ratings

Parameters	Value	Units	Conditions
I _{F(AV)} Max. Aver. Forward Current (Per Leg) (Per Device)	7.5 15	A	@ T _C = 131 °C (Rated V _R)
I _{FSM} Max. Peak One Cycle Non Repetitive Surge	690 150	A	5µs Sine or 3µs Rect. pulse Surge applied at rated load condition halfwave single phase 60Hz Following any rated load condition and with rated V _{RRM} applied
E _{AS} Non-Repetitive Avalanche Energy	7	mJ	(Per Leg) T _J = 25 °C, I _{AS} = 2 Amps, L = 3.5 mH
I _{AR} Repetitive Avalanche Current (Per Leg)	2	A	Current decaying linearly to zero in 1 µsec Frequency limited by T _J max. V _A = 1.5 x V _R typical

Electrical Specifications

Parameters	Value	Units	Conditions
V _{FM} Max. Forward Voltage Drop (1)	0.84 0.57 0.72	V	@ 15A @ 7.5A @ 15A T _J = 25 °C T _J = 125 °C
I _{RM} Max. Instantaneous Reverse Current (1)	0.1 15	mA	T _J = 25 °C T _J = 125 °C Rated DC voltage
C _T Max. Junction Capacitance	400	pF	V _R = 5V _{DC} (test signal range 100Khz to 1Mhz) 25 °C
L _S Typical Series Inductance	8.0	nH	Measured from top of terminal to mounting plane
dv/dt Max. Voltage Rate of Change (Rated V _R)	10000	V/ µs	

(1) Pulse Width < 300µs, Duty Cycle <2%

Thermal-Mechanical Specifications

Parameters	Value	Units	Conditions
T _J Max. Junction Temperature Range	-65 to 150	°C	
T _{stg} Max. Storage Temperature Range	-65 to 175	°C	
R _{thJC} Max. Thermal Resistance Junction to Case (Per Leg)	3.0	°C/W	DC operation
R _{thCS} Typical Thermal Resistance, Case to Heatsink	0.50	°C/W	Mounting surface, smooth and greased
R _{thJA} Max. Thermal Resistance Junction	60	°C/W	DC operation
wt Approximate Weight	2 (0.07)	g (oz.)	
T Mounting Torque	Min. 6 (5) Max. 12 (10)	Kg-cm (lbf-in)	
Device Marking	MBR15..CT MBRB15..CT MBR15..CT-1		Case style TO-220 Case style D ² Pak Case style TO-262

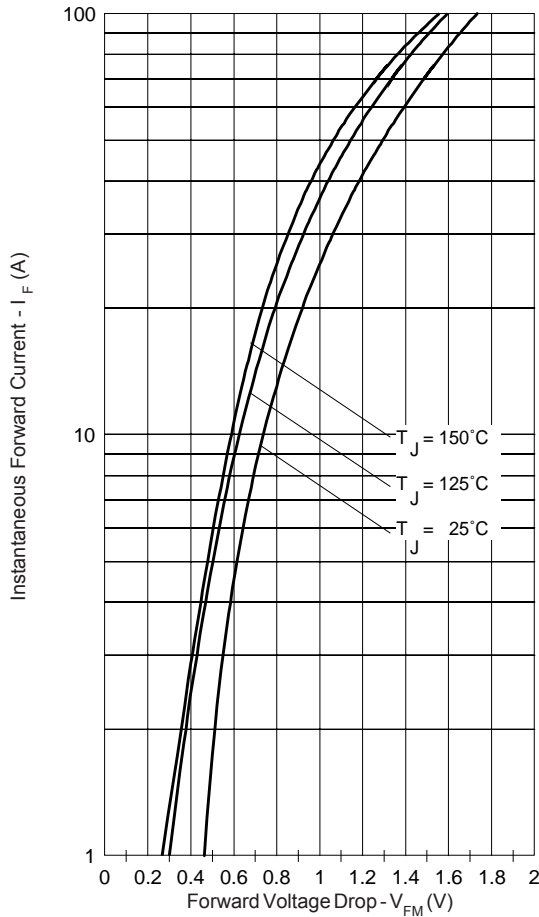

Fig. 1 - Max. Forward Voltage Drop Characteristics (Per Leg)

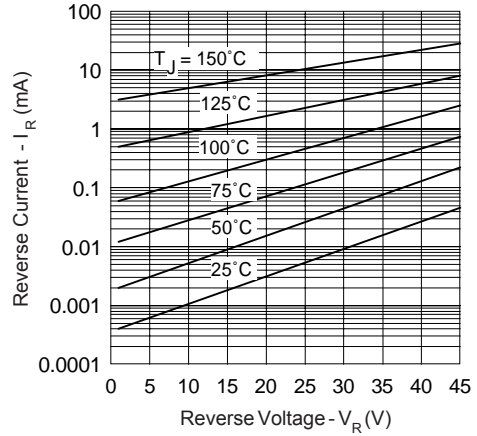

Fig. 2 - Typical Values Of Reverse Current Vs. Reverse Voltage (Per Leg)

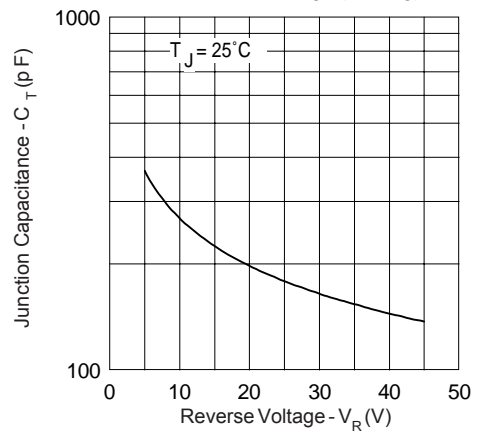

Fig. 3 - Typical Junction Capacitance Vs. Reverse Voltage (Per Leg)

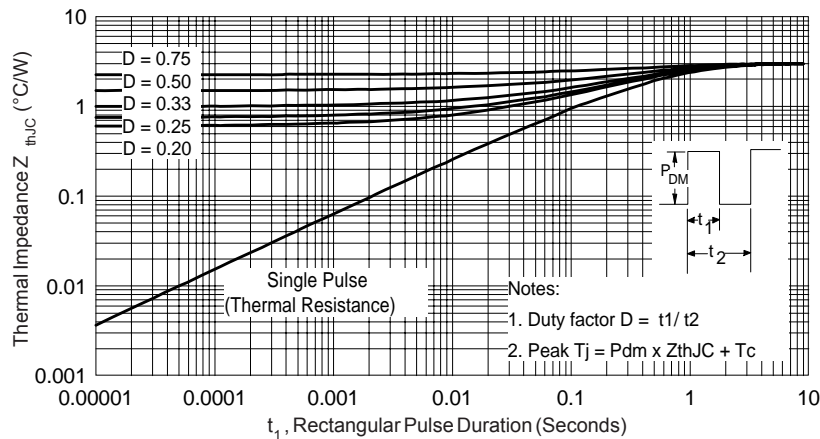

Fig. 4 - Max. Thermal Impedance Z_{thJC} Characteristics (Per Leg)

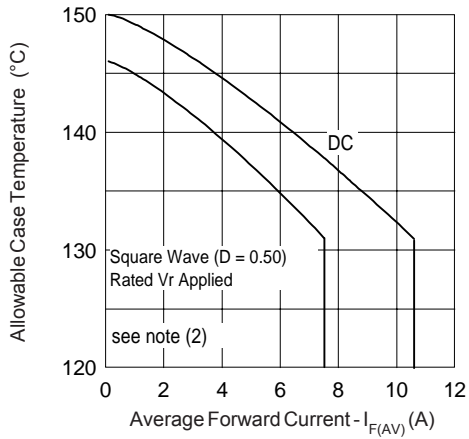

Fig. 5 - Max. Allowable Case Temperature Vs. Average Forward Current

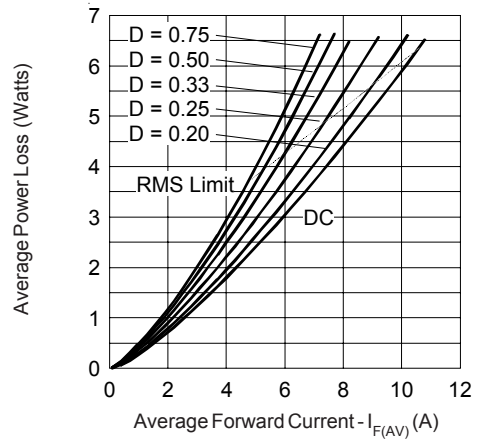

Fig. 6 - Forward Power Loss Characteristics

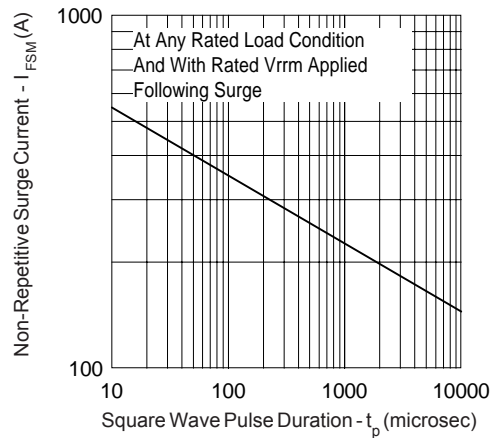
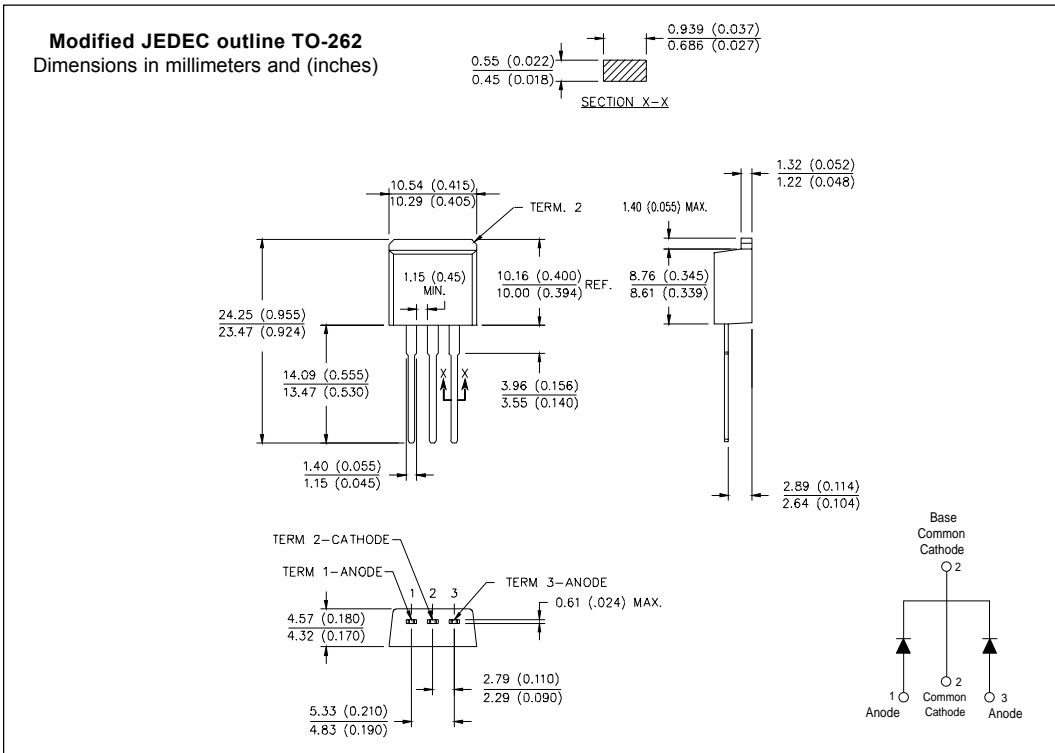
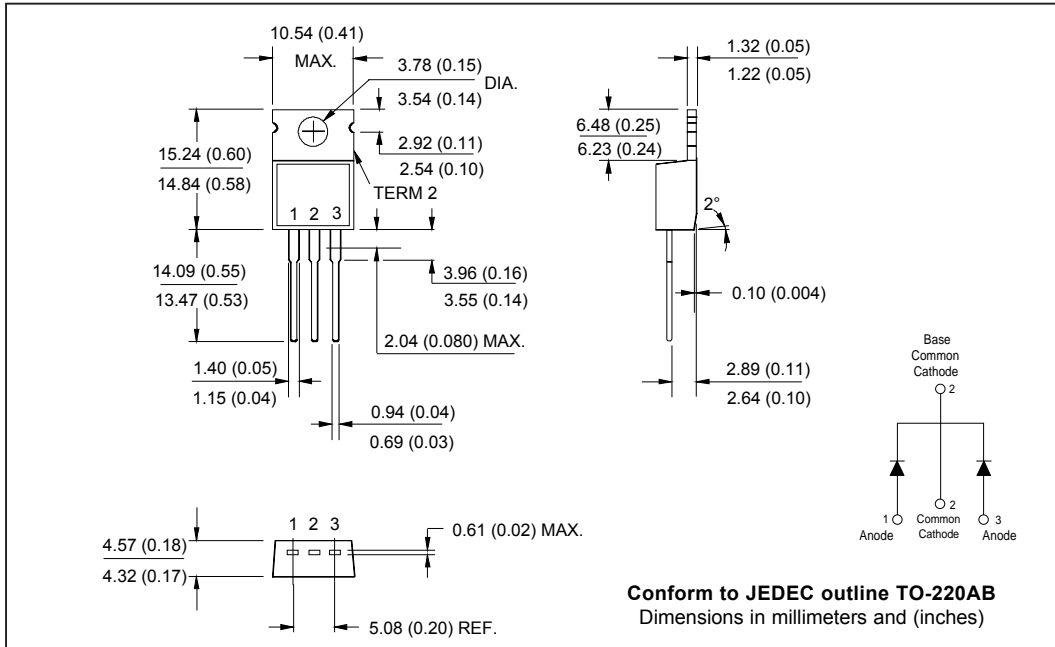

Fig. 7 - Max. Non-Repetitive Surge Current (Per Leg)

- (2) Formula used: $T_C = T_J - (Pd + Pd_{REV}) \times R_{thJC}$;
 $Pd = \text{Forward Power Loss} = I_{F(AV)} \times V_{FM} @ (I_{F(AV)}/D)$ (see Fig. 6);
 $Pd_{REV} = \text{Inverse Power Loss} = V_{R1} \times I_R (1 - D)$; $I_R @ V_{R1} = \text{rated } V_R$

Outline Table



Outline Table

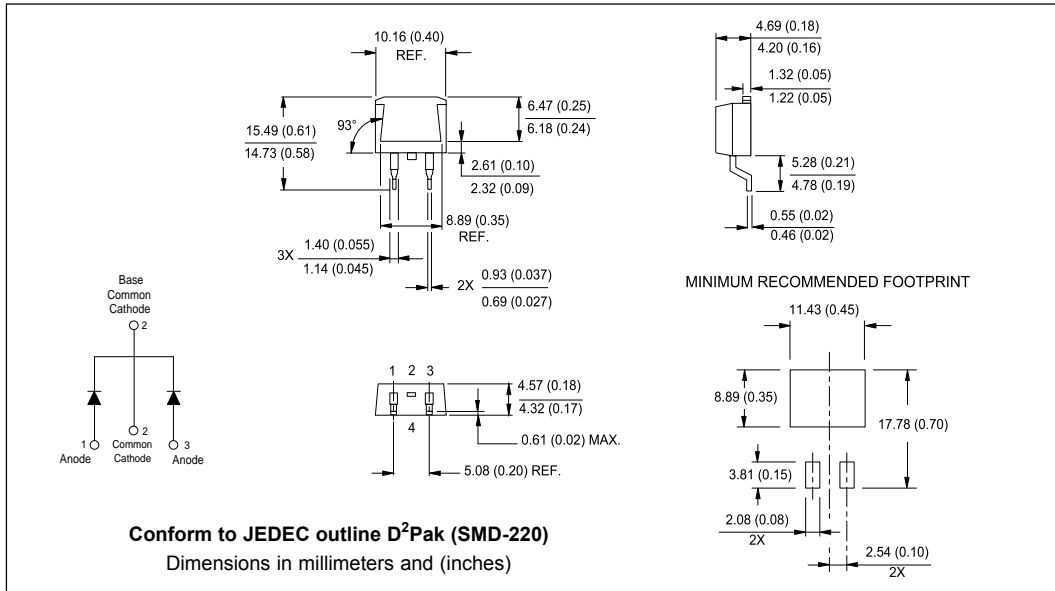

Tape & Reel Information

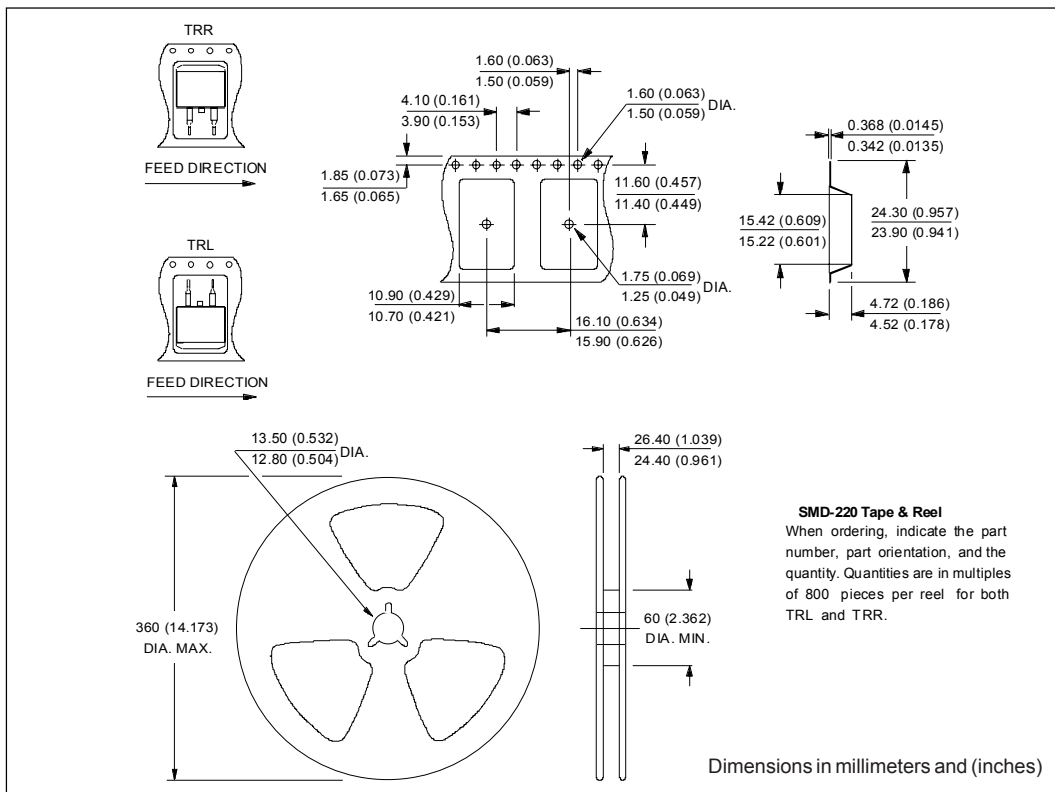

Part Marking Information

<p>EXAMPLE: THIS IS A MBR1545CT LOT CODE 1789 ASSEMBLED ON WW 19, 2000 IN THE ASSEMBLY LINE "C"</p>	<p>INTERNATIONAL RECTIFIER LOGO</p> <p>ASSEMBLY LOT CODE</p> <p>PART NUMBER</p> <p>DATE CODE</p> <p>YEAR 0 = 2000 WEEK 19 LINE C</p>
<p>TO-220</p>	
<p>EXAMPLE: THIS IS A MBRB1545CT LOT CODE 8024 ASSEMBLED ON WW 02, 2000 IN THE ASSEMBLY LINE "L"</p>	<p>INTERNATIONAL RECTIFIER LOGO</p> <p>ASSEMBLY LOT CODE</p> <p>PART NUMBER</p> <p>DATE CODE</p> <p>YEAR 0 = 2000 WEEK 02 LINE L</p>
<p>D²PAK</p>	
<p>EXAMPLE: THIS IS A MBR1545CT-1 LOT CODE 1789 ASSEMBLED ON WW 19, 1999 IN THE ASSEMBLY LINE "C"</p>	<p>INTERNATIONAL RECTIFIER LOGO</p> <p>ASSEMBLY LOT CODE</p> <p>PART NUMBER</p> <p>DATE CODE</p> <p>YEAR 9 = 1999 WEEK 19 LINE C</p>
<p>TO-262</p>	

```

MBR1545CT
*****
*      This model has been developed by      *
*      Wizard SPICE MODEL GENERATOR (1999) *
*      (International Rectifier Corporation) *
*      contains Proprietary Information     *
*****
* SPICE Model Diode is composed by a      *
* simple diode plus paralled VCG2T        *
*****
.SUBCKT MBR1545 ANO CAT
D1 ANO 1 DMOD (0.03191)
*Define diode model
.MODEL DMOD D(IS=9.72464638473799E-05A,N=1.30648926537753,BV=52V,
+ IBV=0.195508065728349A,RS= 0.000727548,CJO=1.94829876431799E-08,
+ VJ=2.27282978121533,XTI=2, EG=0.854458710837653)
*****
*Implementation of VCG2T
VX 1 2 DC 0V
R1 2 CAT TRES 1E-6
.MODEL TRES RES(R=1,TC1=27.6281424524011)
GP1 ANO CAT VALUE={-ABS(I(VX))*(EXP((( -5.219758E-03/27.62814)*(V(2,CAT)*1E6)/
(I(VX)+1E-6)-1))+1)*7.000165E-02*ABS(V(ANO,CAT))-1)}
*****
.ENDS MBR1545

Thermal Model Subcircuit
.SUBCKT MBR1545 5 1

CTHERM1      5      4      1.05E+00
CTHERM2      4      3      4.44E+00
CTHERM3      3      2      1.16E+01
CTHERM4      2      1      6.12E+01

RTHERM1      5      4      1.33E+00
RTHERM2      4      3      1.19E+00
RTHERM1      3      2      3.81E-01
RTHERM1      2      1      9.54E-02

.ENDS MBR1545
    
```

Ordering Information Table

Device Code															
	<table border="1" style="margin: auto;"> <tr> <td style="padding: 5px;">MBR</td> <td style="padding: 5px;">B</td> <td style="padding: 5px;">15</td> <td style="padding: 5px;">45</td> <td style="padding: 5px;">CT</td> <td style="padding: 5px;">-1</td> <td style="padding: 5px;">TRL</td> </tr> <tr> <td style="text-align: center;">①</td> <td style="text-align: center;">②</td> <td style="text-align: center;">③</td> <td style="text-align: center;">④</td> <td style="text-align: center;">⑤</td> <td style="text-align: center;">⑥</td> <td style="text-align: center;">⑦</td> </tr> </table>	MBR	B	15	45	CT	-1	TRL	①	②	③	④	⑤	⑥	⑦
MBR	B	15	45	CT	-1	TRL									
①	②	③	④	⑤	⑥	⑦									
1	- Essential Part Number														
2	- B = D ² Pak only														
3	- Current Rating (15 = 15A)														
4	- Voltage Rating														
5	- CT = Essential Part Number														
6	- "-1" = TO-262 only														
7	- <ul style="list-style-type: none"> • none = Tube (50 pieces) • TRL = Tape & Reel (Left Oriented - for D²Pak only) • TRR = Tape & Reel (Right Oriented - for D²Pak only) 														

35	= 35V
45	= 45V

Data and specifications subject to change without notice.
 This product has been designed and qualified for Industrial Level.
 Qualification Standards can be found on IR's Web site.