

GP Batteries

Data Sheet

Rechargeable Nickel Metal Hydride Battery

Model: GP270AAHC

Revision History

Revision	Date	Initiator	Change description
04	2014-5-26	YQ Chen	New format

Prepared by	Checked by	Approver
RD Engineer	RD Manager	SM
YQ Chen	Jackie Yu	Vivian Fong
Date: 2014-5-26	Date: 2014-5-26	Date: 2014-5-26

GPI International Limited

Gold Peak Building, 8/F, 30 Kwai Wing Road,
Kwai Chung, New Territories, Hong Kong.

Tel: (852) 2484 3333 Fax: (852) 24805912

Email: gpii@goldpeak.com

Website: <http://www.gpbatteries.com>

Type	: Rechargeable Nickel Metal Hydride Cylindrical Cell
Nominal Dimension (with Sleeve)	: $\Phi = 14.5\text{mm}$ H = 50.5mm
Applications	: Recommended discharge current 260 to 7800mA
Nominal Voltage	: 1.2V
Capacity	: Nominal: 2600mAh Minimum: 2600mAh Typical: 2600mAh When discharged at 520mA to 1.0V at 20°C
Charging Condition	: 260mA for 16 hrs at 20°C
Charging Retention	: 70% of nominal capacity after cell storage at 20°C for 6months, 50% of nominal capacity after cell storage at 20°C for 1year When discharged at 520mA to 1.0V at 20°C
Fast Charge	: 1300mA to 2600mA (0.5 to 1C) charge termination control recommended control parameters: - ΔV : 0-5mV DT/dt : 0.8°C/min (0.5 to 0.9C) 0.8 - 1°C/min (1C) TCO : 45 - 50°C Timer : 100% nominal input (for ref. only)
Service Life	: ~300 cycles (IEC standard)
Continuous Overcharge	: 260mA maximum current for 1 year. No conspicuous deformation and/or leakage
Weight	: 31.0g
Internal Resistance	: Average 20m Ω upon fully charged (Max.28m Ω) at 1000Hz
Max. Charging Voltage	: 1.5V at 260mA charging
Ambient Temperature Range	: Standard Charge : 0 to 45°C Fast Charging : 10 to 45°C Discharge : -20 to 50°C Storage : -20 to 35°C

Model No.: **GP270AAHC**

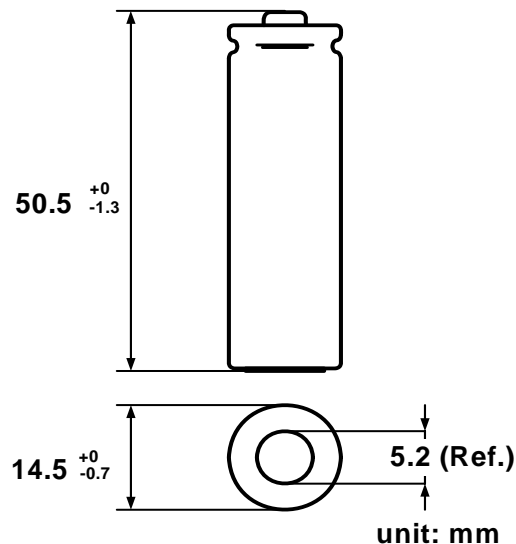

Low Rate Discharge

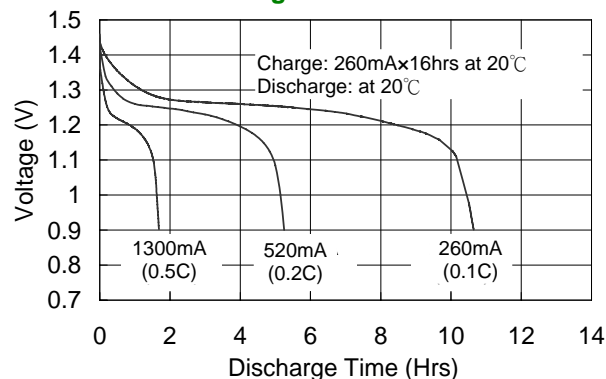

Fast Charge (Charge Control Required)

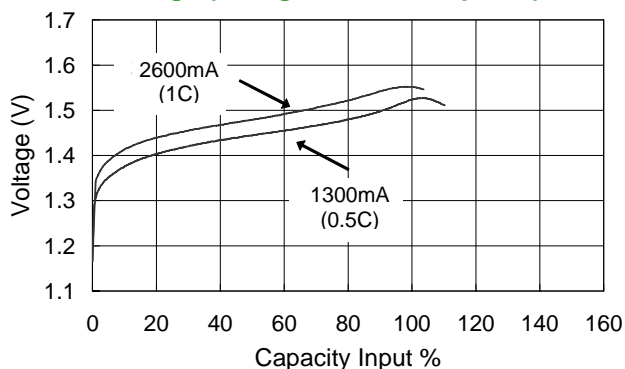

High Rate Discharge

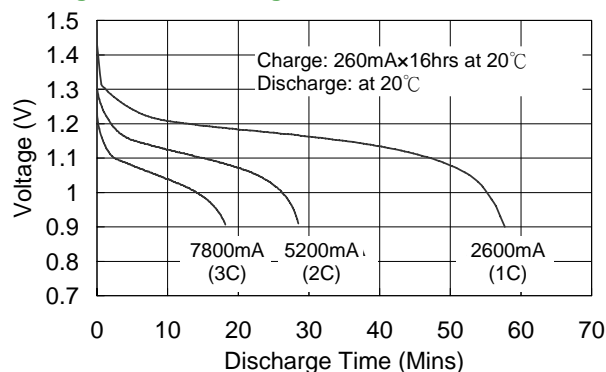

The information (subject to change without prior notice) contained in this document is for reference only and should not be used as a basis for product guarantee or warranty. For applications other than those described here, please consult your nearest GP Sales and Marketing Office or Distributors.