

# SIEMENS

## SIRIUS

Sanftstarter 3RW40

Soft starter 3RW40

Démarrreur progressif 3RW40

Arrancador suave 3RW40

Avviatore dolce 3RW40

Chave de partida suave 3RW40

Yumuşak yol verici 3RW40

Устройство плавного пуска 3RW40

软启动器 3RW40

3RW40 2

3RW40 3

3RW40 4



EN/IEC 60947-4-2

<b>DE</b>	<b>Sanftstarter 3RW40</b> Betriebsanleitung — Bestell-Nr.: 3ZX1012-0RW40-2DA1 Grafiken	Seite 2 - 4 29 - 32
Sicherheits- und Inbetriebnahmehinweise für explosionsgefährdete Bereiche — Bestell-Nr.: 3ZX1012-0RW40-1CA1		
<b>EN</b>	<b>Soft starter 3RW40</b> Operating instructions — Order No.: 3ZX1012-0RW40-2DA1 Graphics	Page 5 - 7 29 - 32
Safety and commissioning instructions for hazardous areas — Order No.: 3ZX1012-0RW40-1CA1		
<b>FR</b>	<b>Démarrreur progressif 3RW40</b> Instructions de service — N° de référence : 3ZX1012-0RW40-2DA1 Graphiques	Page 8 - 10 29 - 32
Consignes de sécurité et de mise en service pour les zones explosibles — N° de référence : 3ZX1012-0RW40-1CA1		
<b>ES</b>	<b>Arrancador suave 3RW40</b> Instructivo — Referencia: 3ZX1012-0RW40-2DA1 Gráficos	Página 11 - 13 29 - 32
Instrucciones de seguridad y puesta en servicio en entornos con peligro de explosión — Referencia: 3ZX1012-0RW40-1CA1		
<b>IT</b>	<b>Avviatore dolce 3RW40</b> Istruzioni operative — N° di ordinaz.: 3ZX1012-0RW40-2DA1 Grafiche	Pagina 14 - 16 29 - 32
Indicazioni di sicurezza e per la messa in servizio in aree con pericolo d'esplosione — N° di ordinaz.: 3ZX1012-0RW40-1CA1		
<b>PT</b>	<b>Chave de partida suave 3RW40</b> Instruções de Serviço — N° de enc.: 3ZX1012-0RW40-2DA1 Gráficos	Página 17 - 19 29 - 32
Indicações de segurança e de colocação em funcionamento para áreas apresentando risco de explosão — N° de enc.: 3ZX1012-0RW40-1CA1		
<b>TR</b>	<b>Yumuşak yol verici 3RW40</b> İşletme kılavuzu — Sipariş no.: 3ZX1012-0RW40-2DA1 Grafikler	Sayfa 20 - 22 29 - 32
Patlama tehlikesi altında bulunan bölgeler için emniyet ve hizmete alma bilgileri — Sipariş no.: 3ZX1012-0RW40-1CA1		
<b>PY</b>	<b>Устройство плавного пуска 3RW40</b> Инструкция по эксплуатации — № заказа: 3ZX1012-0RW40-2DA1 Графики	Страница 23 - 25 29 - 32
Указания по технике безопасности и вводу в эксплуатацию во взрывоопасных зонах — № заказа: 3ZX1012-0RW40-1CA1		
<b>中文</b>	<b>软启动器 3RW40</b> 操作规程 - 订货号: 3ZX1012-0RW40-2DA1 图表	第 26 - 28 和 29 - 32 页
用于受爆炸威胁区域的安全及首次启动运行说明 — 订购编号: 3ZX1012-0RW40-1CA1		



[www.siemens.com/lowvoltage/manuals](http://www.siemens.com/lowvoltage/manuals)

**SIRIUS-Systemhandbuch / SIRIUS system manual** : <http://www.siemens.de/sirius-systemhandbuch>

**Technical Assistance:** Telephone: +49 (0) 911-895-5900 (8° - 17° CET) Fax: +49 (0) 911-895-5907  
E-mail: [technical-assistance@siemens.com](mailto:technical-assistance@siemens.com)  
Internet: [www.siemens.de/lowvoltage/technical-assistance](http://www.siemens.de/lowvoltage/technical-assistance)

**Technical Support:** Telephone: +49 (0) 180 50 50 222

Vor der Installation, dem Betrieb oder der Wartung des Geräts muss diese Anleitung gelesen und verstanden werden.

**⚠ GEFAHR**

**Gefährliche Spannung. Lebensgefahr oder schwere Verletzungsgefahr.**  
Vor Beginn der Arbeiten Anlage und Gerät spannungsfrei schalten.

**VORSICHT**

Eine sichere Gerätefunktion ist nur mit zertifizierten Komponenten gewährleistet!

**⚠ GEFAHR**

**Gefährliche Spannung. Lebensgefahr oder schwere Verletzungsgefahr.**  
Um elektrischen Stromschlag oder Verbrennungen zu vermeiden, dürfen die Klemmen des Motorsteuergeräts nicht berührt werden, wenn das Gerät mit Spannung versorgt wird. An den Ausgangsklemmen steht auch im AUS-Zustand des Motorsteuergeräts Spannung an.

**VORSICHT**

**Einbauabstände in Einzelaufstellung (Dicht-an-dicht-Aufstellung siehe Sanftstarter-Handbuch)**

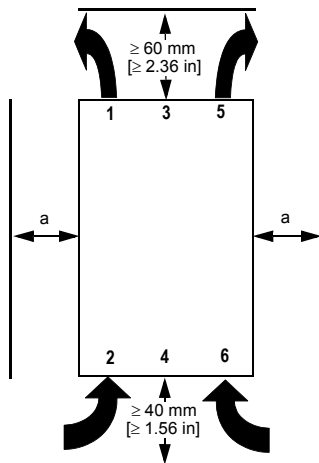

a) 3RW40 2: 15 mm [0.59 in]  
3RW40 3; 3RW40 4: 30 mm [1.18 in]

**ACHTUNG**

Beachten Sie beim Einbau des Geräts die angegebenen Abstände, damit genügend Luft für Kühlung zirkulieren kann. Das Gerät wird von unten nach oben belüftet.

**VORSICHT**

**Gefahr von Sachschäden.**  
Achten Sie darauf, dass keine Flüssigkeit, kein Staub oder leitender Gegenstand in den Sanftstarter gelangt.

**Motorstromeinstellwerte**

Zulässige Motorstromeinstellwerte in Abhängigkeit von der CLASS-Einstellung bei 40° C Umgebungstemperatur

	$I_e$ [A]	$I_{min}$ [A]	$I_{max}$ [A] CLASS 10	$I_{max}$ [A] CLASS 15	$I_{max}$ [A] CLASS 20
3RW40 24-...	12,5	5	12,5	11	10
3RW40 26-...	25,3	10,3	25,3	23	21
3RW40 27-...	32,2	17,2	32,2	30	27
3RW40 28-...	38	23	38	34	31
3RW40 36-...	45	22,5	45	42	38
3RW40 37-...	63	25,5	63	50	46
3RW40 38-...	72	34,5	72	56	50
3RW40 46-...	80	42,5	80	70	64
3RW40 47-...	106	46	106	84	77

**Programmieren des ON/RUN Ausgangs 13/14 (Werkseinstellung: ON) (Grafikteil, Bild 3)**

- 1. Programmierung starten:** (Beim Gerät 3RW40 2 die Abdeckung wie in Bild 2 gezeigt entfernen.) Die Taste "RESET MODE" (2) länger als 2 s drücken, bis die LED "DEVICE" (5) grün flimmert. Die Taste "RESET MODE" (2) gedrückt halten und zusätzlich die Taste "RESET/TEST" (1) länger als 1 s drücken, bis die LED "DEVICE" (5) am Gerät rot leuchtet.
- 2. Modus anzeigen:** LED "STATE/BYPASSED/FAILURE" (6) blinkt grün: ON-Modus. LED "STATE/BYPASSED/FAILURE" (6) flimmert grün: RUN-Modus.
- 3. Modus wechseln:** Taste "RESET MODE" (2) drücken.
- 4. Programmierung beenden und Einstellungen speichern:** Taste "RESET/TEST" (1) länger als 1 s drücken, bis die LED "DEVICE" (5) grün leuchtet.

# Schnellinbetriebnahmeanleitung

## Thermistoranschluss (nur 3RW40.-TB0.)

- Anschluss Thermoclick gemäß Bild 6.3 (Drahtbrücke entfernen)
- Anschluss PTC Typ A gemäß Bild 6.4 (Drahtbrücke entfernen)

### VORSICHT

#### Gefahr von Sachschäden.

Anschluss an nicht belegte Klemmen ist unzulässig.

Einstellungsvorschlag	Anlauf Parameter			Auslauf Parameter
Applikation	Startspannung %	Anlaufzeit s	Strombegrenzungswert	Auslaufzeit s
Förderband	70	10	5 x I <sub>e</sub>	5
Rollenförderer	60	10	5 x I <sub>e</sub>	5
Kompressor	50	10	4 x I <sub>e</sub>	0
kleiner Ventilator	40	10	4 x I <sub>e</sub>	0
Pumpe	40	10	4 x I <sub>e</sub>	10
Hydraulikpumpe	40	10	4 x I <sub>e</sub>	0
Rührwerk	40	20	4 x I <sub>e</sub>	0
Fräsmaschine	40	20	4 x I <sub>e</sub>	0

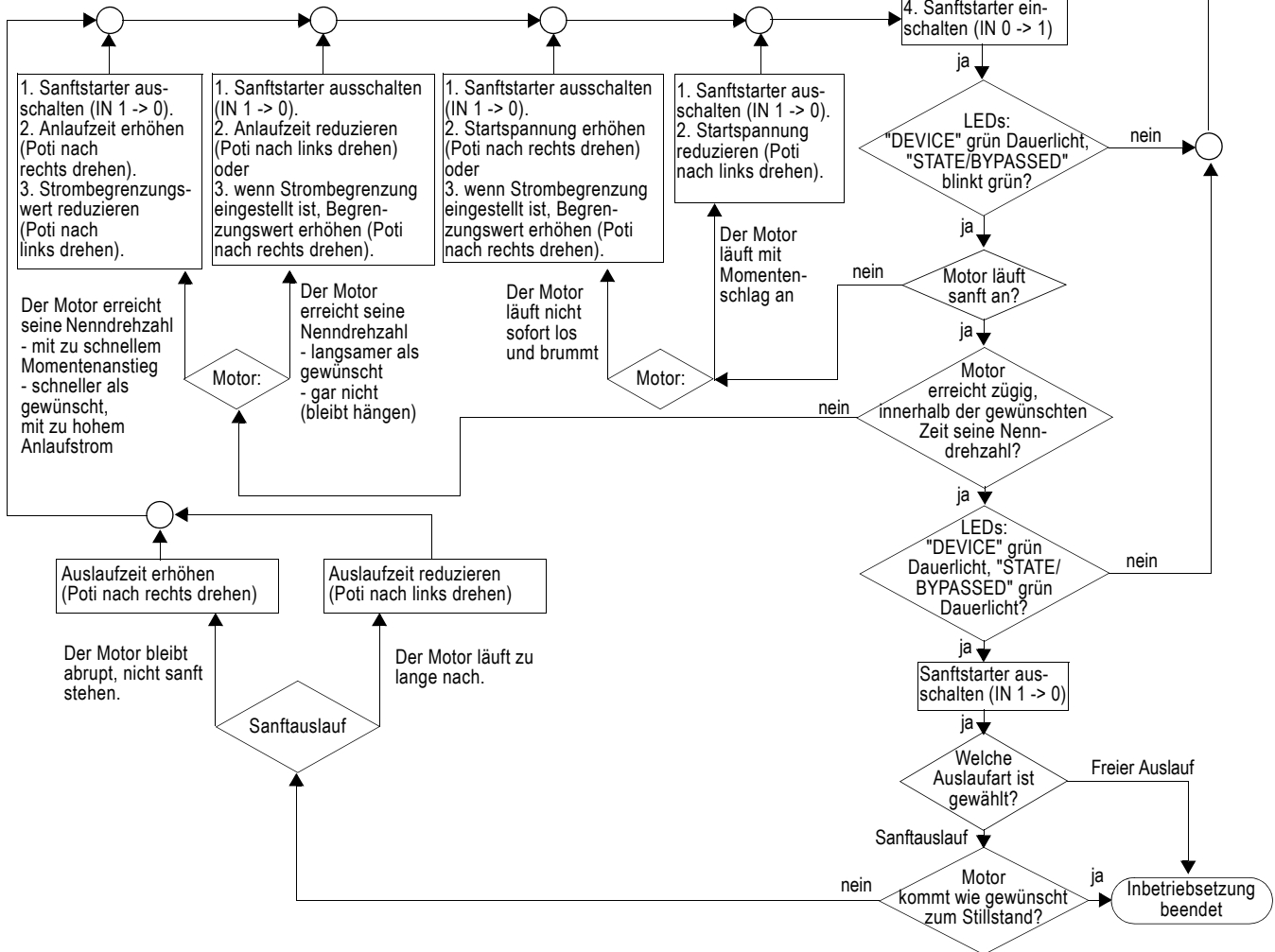
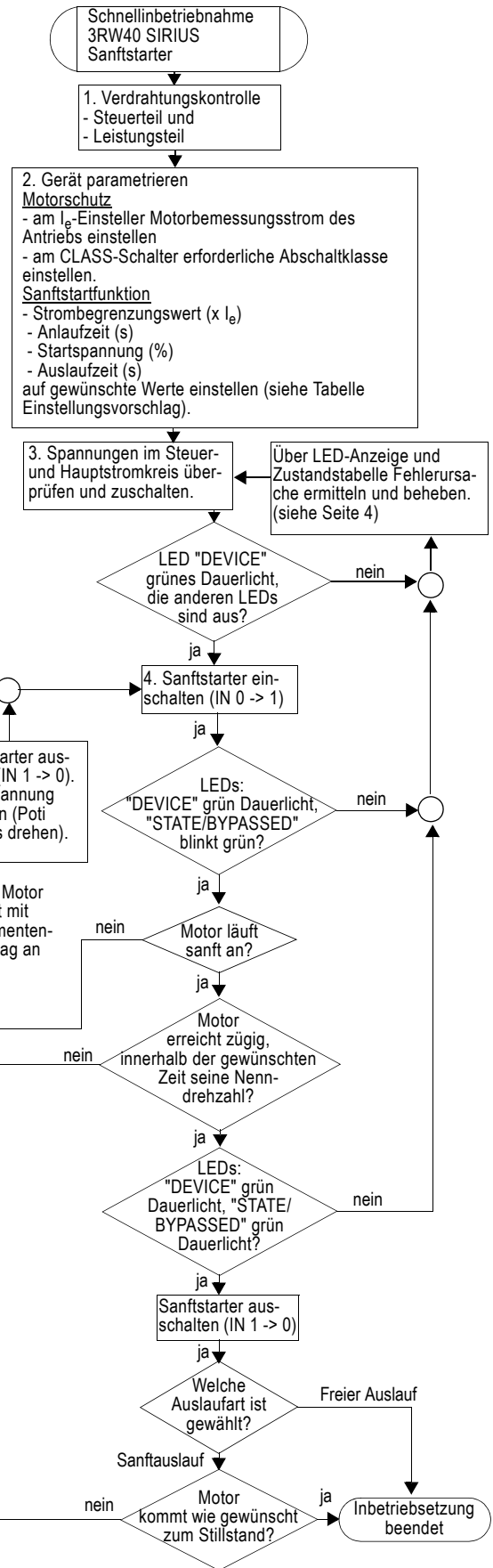

## Anzeigenübersicht

		LED-Anzeigen 3RW40				Hilfskontakte					
		Sanftstarter		Motorschutz		13 14 (ON)		13 14 (RUN)		24 23 (BYPASSED)	
3RW40		DEVICE (rd/gn/ylw)	STATE / BYPASSED / FAILURE (gn/rd)	OVERLOAD (rd)	RESET MODE (ylw/gn)						
U <sub>s</sub> = 0		●	●	●	●						
Betriebszustand	IN										
Aus	0	gn	●	●	●						
Anlauf	1	gn	gn	●	●						
Bypassed	1	gn	gn	●	●						
Auslauf	0	gn	gn	●	●						
<b>Warnung</b>											
I <sub>e</sub> /Class-Einstellung unzulässig		gn	gn  gn		●						
Start gesperrt, Gerät zu warm		ylw	●	●	●						
<b>Fehler</b>											
Versorgungsspannung Elektronik unzulässig		●	rd	●	●						
unzulässige I <sub>e</sub> /Class-Einstellung und IN (0 -> 1)		gn	rd		●						
Motorschutzabschaltung Überlastrelais / Thermistor		gn	●		●						
Thermistormotorschutz Drahtbruch / Kurzschluss		gn	●		●						
Thermische Überlastung Gerät		ylw	rd	●	●						
- fehlende Lastspannung - Phasenausfall, fehlende Last		gn	rd	●	●						
Gerätefehler		rd	rd	●	●						
<b>Testfunktion</b>											
1) TEST t > 5 s drücken		gn	●	rd	●						
<b>RESET MODE (Drücken zum Wechseln)</b>											
Manual Reset		●	●	●	●						
Auto Reset		●	●	●	ylw						
Remote Reset siehe Bild 6.2		●	●	●	gn						

Anzeige der LEDs							1) Test Motorschutzabschaltung
				gn = grün	ylw = gelb	rd = rot	
aus	ein	blinkend	flimmernd				

### ⚠️ WARNUNG



#### Automatischer Wiederanlauf.

**Kann zu Tod, schwerer Körperverletzung oder Sachbeschädigung führen.**

Der automatische Rücksetzmodus (RESET MODE) darf nicht in Anwendungen verwendet werden, in denen der unerwartete Neustart des Motors nach Ablauf der Wiederbereitschaftszeit zu Personen- oder Sachschäden führen kann.

Der Startbefehl (z. B. durch die SPS) muss vor einem Resetbefehl zurückgesetzt werden, da bei anstehendem Startbefehl nach dem Resetbefehl automatisch ein erneuter, selbsttätiger Wiederanlauf erfolgt. Dies gilt insbesondere bei Motorschutzauslösung. Aus Sicherheitsgründen wird empfohlen, den Sammelfehlerausgang (Klemmen 95 und 96) in die Steuerung einzubinden.

Read and understand these instructions before installing, operating, or maintaining the equipment.

**⚠ DANGER**

**Hazardous voltage.**  
**Will cause death or serious injury.**  
 Turn off and lock out all power supplying this device before working on this device.

**CAUTION**

Reliable functioning of the equipment is only ensured with certified components.

**⚠ DANGER**

**Hazardous voltage.**  
**Will cause death or serious injury.**  
 The terminals of the motor control device must not be touched when it is connected to a voltage in order to prevent electrical shocks or burning. The output terminals of the motor control device are connected to a voltage even when it is in the OFF state.

### Stand-alone installation spacings (see soft starter manual for side-by-side installation)

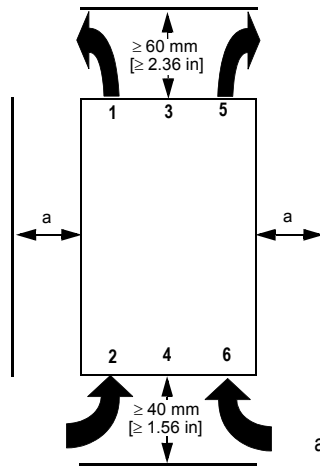

#### NOTICE

Please adhere to the specified spacings when installing the device so that sufficient air can circulate for ventilation. The unit is ventilated from bottom to top.

#### CAUTION

**Risk of damage to property.**  
 Ensure that no liquids, dust or conductive parts enter the soft starter.

#### NOTE

**Surrounding air temperature** - A rating assigned to open type equipment that refers to the maximum ambient temperature of air immediately surrounding the equipment inside of the ultimate enclosure.

- a) 3RW40 2: 15 mm [0.59 in]  
 3RW40 3; 3RW40 4: 30 mm [1.18 in]

### Setpoint values for motor current

Permitted setpoint values for the motor current, dependent on the CLASS setting at 40 °C surrounding air temperature

	$I_e$ [A]	$I_{min}$ [A]	$I_{max}$ [A] CLASS 10	$I_{max}$ [A] CLASS 15	$I_{max}$ [A] CLASS 20
3RW40 24-...	12.5	5	12.5	11	10
3RW40 26-...	25.3	10.3	25.3	23	21
3RW40 27-...	32.2	17.2	32.2	30	27
3RW40 28-...	38	23	38	34	31
3RW40 36-...	45	22.5	45	42	38
3RW40 37-...	63	25.5	63	50	46
3RW40 38-...	72	34.5	72	56	50
3RW40 46-...	80	42.5	80	70	64
3RW40 47-...	106	46	106	84	77

### Programming the ON/RUN output 13/14 (factory setting: ON) (Fig. 3 in graphics section)

- Start programming mode:** (For the 3RW40 2 device, remove the cover as shown in Figure 2.) Press and hold the "RESET MODE" button (2) for longer than 2 seconds until the LED "DEVICE" (5) flickers green. While pushing the "RESET MODE" button (2), press the "RESET/TEST" button (1) for longer than 1 second until the LED "DEVICE" (5) on the device lights up red.
- Display mode:** LED "STATE/BYPASSED/FAILURE" (6) flashes green: ON mode. LED "STATE/BYPASSED/FAILURE" (6) flickers green: RUN mode.
- Change mode:** Press the "RESET MODE" (2) button.
- Exit programming mode and save settings:** Press and hold the "RESET/TEST" button (1) for longer than 1 second until the LED "DEVICE" (5) lights up green.

# Quick commissioning instructions

## Thermistor connection (3RW40.-TB0. only)

- Thermoclick connection according to Fig. 6.3 (remove jumper)
- PTC connection type A according to Fig. 6.4 (remove jumper)

English

**CAUTION**  
**Risk of damage to property.**  
 Connection to an unassigned terminal is not permitted.

Suggested setting	Startup parameters			Stopping parameters
Application	Start voltage %	Startup time s	Current limit value	Stopping time s
Conveyor belt	70	10	5 x I <sub>e</sub>	5
Roller conveyor	60	10	5 x I <sub>e</sub>	5
Compressor	50	10	4 x I <sub>e</sub>	0
Small fan	40	10	4 x I <sub>e</sub>	0
Pumps	40	10	4 x I <sub>e</sub>	10
Hydraulic pump	40	10	4 x I <sub>e</sub>	0
Stirrers	40	20	4 x I <sub>e</sub>	0
Milling machines	40	20	4 x I <sub>e</sub>	0

Quick commissioning of the 3RW40 SIRIUS soft starter

1. Wiring control  
 - Control part and  
 - Performance part

2. Configure device  
Motor protection  
 - Set the rated motor current of the device using the I<sub>e</sub> controller  
 - Set the required tripping class with the CLASS switch.  
Set the soft start function  
 - Current limit value (x I<sub>e</sub>)  
 - Startup time (s)  
 - Start voltage (%)  
 - Stopping time (s)  
 to the desired value (see table for suggested settings).

3. Check and connect the voltages in the control and main circuits.  
 Determine and rectify the cause of the fault using the LED display and the status table (see Page 7).

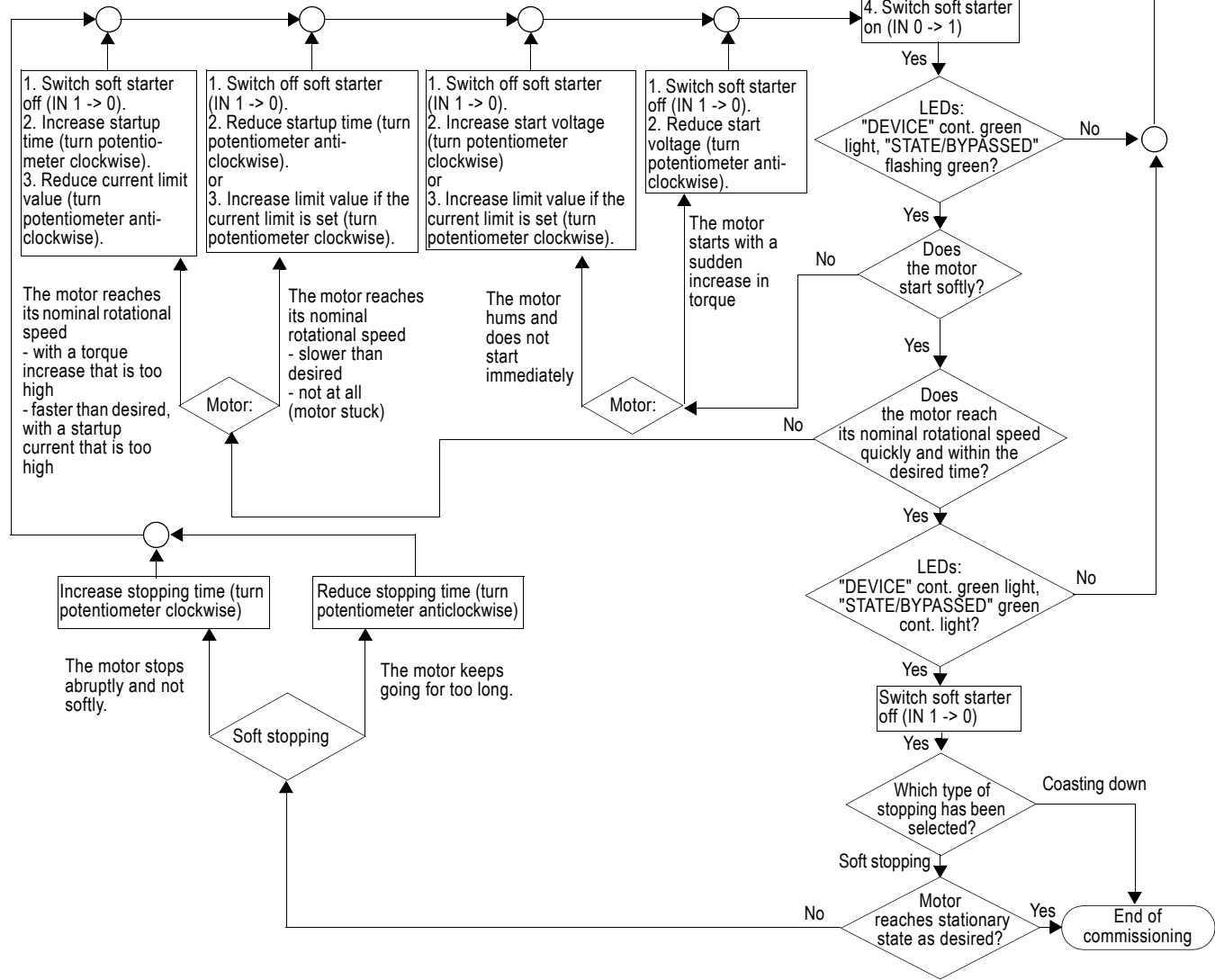

# Display overview

		LED displays on 3RW40				Auxiliary contacts			
		Soft starter		Motor protection					
3RW40		DEVICE (rd/gn/ylw)	STATE / BYPASSED / FAILURE (gn/rd)	OVERLOAD (rd)	RESET MODE (ylw/gn)	13 14 (ON)	13 14 (RUN)	24 23 (BYPASSED)	96 95 98 FAILURE / OVERLOAD
$U_s = 0$		●	●	●	●				
Operating state	IN								
OFF	0	gn	●	●	●				
Start-up	1	gn	gn	●	●				
Bypassed	1	gn	gn	●	●				
Run-out	0	gn	gn	●	●				
Warning									
$I_e$ / class setting invalid		gn	gn  gn		●				
Start-up locked, device too warm		ylw	●	●	●				
Error									
Supply voltage electronics invalid		●	rd	●	●				
Invalid $I_e$ / class setting and IN (0 -> 1)		gn	rd		●				
Motor protection switch-off Overload relay / thermistor		gn	●		●				
Thermistor motor protection Wire break / short circuit		gn	●		●				
Thermal overload device		ylw	rd	●	●				
- Missing load voltage - Phase failure, no load		gn	rd	●	●				
Device fault		rd	rd	●	●				
Test function									
1) Press TEST for $t > 5$ s		gn	●		●				
RESET MODE (press to change)									
Manual Reset		●	●	●	●				
Auto Reset		●	●	●	ylw				
Remote Reset see Fig. 6.2		●	●	●	gn				
LED display									
				gn = green	ylw = yellow	rd = red	1) Motor protection shutdown test		
OFF	ON	flashing	flickering						

**⚠ WARNING**

**Automatic restart.**  
**May result in death, serious injury or damage to property.**  
 The automatic reset mode (RESET MODE) must not be used in applications where an unexpected restart of the motor after the recovery time has elapsed may lead to personal injury or damage to property.  
 The start command (e.g. by the PLC) must be reset before a reset command, since an automatic restart is executed when a start command is pending after the reset command. This especially applies to motor protection tripping. For safety reasons it is recommended to integrate the group fault output (terminals 95 and 96) into the control.

Ne pas installer, utiliser ou intervenir sur cet équipement avant d'avoir lu et assimilé les présentes instructions et notamment les conseils de sécurité et mises en garde qui y figurent.

**⚠ DANGER**

**Tension dangereuse.  
Danger de mort ou risque de blessures graves.**  
Mettre hors tension avant d'intervenir sur l'appareil.

**PRUDENCE**

La sécurité de fonctionnement de l'appareil n'est garantie qu'avec des composants certifiés.

**⚠ DANGER**

**Tension dangereuse.  
Danger de mort ou risque de blessures graves.**  
Il est interdit de toucher les bornes du bloc de commande du moteur lorsque l'appareil est sous tension pour éviter les chocs électriques ou les brûlures. Une tension est présente aux bornes de sortie même à l'ARRET du bloc de commande du moteur.

**Distances de montage pour installation séparée (installation juxtaposée, voir le manuel Démarrateurs progressifs)**

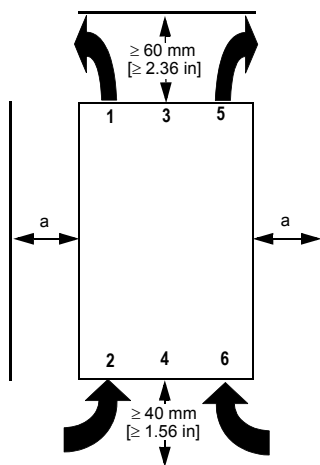

**IMPORTANT**

Veuillez respecter au montage de l'appareil les distances indiquées pour assurer une circulation suffisante de l'air de refroidissement. L'appareil est ventilé du bas vers le haut.

**PRUDENCE**

**Risque de dommages matériels.**  
Veillez à ce que ni liquide, ni poussière ou objet conducteur ne puisse pénétrer dans le démarreur progressif.

a) 3RW40 2 : 15 mm [0.59 in]  
3RW40 3 ; 3RW40 4 : 30 mm [1.18 in]

**Valeurs de réglage du courant du moteur**

Valeurs de réglage du courant du moteur admissible en fonction du CLASS à une température ambiante de 40° C

	$I_e$ [A]	$I_{min}$ [A]	$I_{max}$ [A] CLASS 10	$I_{max}$ [A] CLASS 15	$I_{max}$ [A] CLASS 20
3RW40 24-...	12,5	5	12,5	11	10
3RW40 26-...	25,3	10,3	25,3	23	21
3RW40 27-...	32,2	17,2	32,2	30	27
3RW40 28-...	38	23	38	34	31
3RW40 36-...	45	22,5	45	42	38
3RW40 37-...	63	25,5	63	50	46
3RW40 38-...	72	34,5	72	56	50
3RW40 46-...	80	42,5	80	70	64
3RW40 47-...	106	46	106	84	77

**Programmation de la sortie ON/RUN 13/14 (réglage standard : ON) (partie graphique, figure 3)**

- Lancement de la programmation :** (retirez tout d'abord le couvercle de l'appareil 3RW40 2 comme le montre la figure 2.) Appuyez sur la touche "RESET MODE" (2) pendant plus de 2 secondes jusqu'à ce que la LED verte "DEVICE" (5) scintille. Maintenez la touche "RESET MODE" (2) appuyée et pressez la touche "RESET/TEST" (1) pendant plus d'1 s, jusqu'à ce que la LED rouge "DEVICE" (5) scintille sur l'appareil.
- Affichage du mode :** la LED verte "STATE/BYPASSED/FAILURE" (6) clignote : mode ON. La LED verte "STATE/BYPASSED/FAILURE" (6) scintille : mode RUN.
- Changement de mode :** appuyez sur la touche "RESET MODE" (2).
- Fin de la programmation et enregistrement des réglages :** appuyez sur la touche "RESET/TEST" (1) pendant plus d'1 seconde jusqu'à ce que la LED verte "DEVICE" (5) s'allume.

Français



# Instructions de mise en service rapide

## Raccordement de thermistance (uniquement 3RW40.-TB0.)

- Raccordement du thermoclick selon la figure 6.3 (retirer les ponts à fil)
- Raccordement PTC type A selon la figure 6.4 (retirer les ponts à fil)

### PRUDENCE

**Risque de dommages matériels.**  
Un raccordement aux bornes libres est inadmissible.

Proposition de réglage	Paramètres de démarrage			Paramètres de ralentissement
	Tension démarrage %	Temps dém. s	Val. limitation courant	Temps ralent. s
Application				
Convoyeur	70	10	5 x I <sub>e</sub>	5
Convoyeur à rouleaux	60	10	5 x I <sub>e</sub>	5
Compresseur	50	10	4 x I <sub>e</sub>	0
Petit ventilateur	40	10	4 x I <sub>e</sub>	0
Pompe	40	10	4 x I <sub>e</sub>	10
Pompe hydraulique	40	10	4 x I <sub>e</sub>	0
Malaxeur	40	20	4 x I <sub>e</sub>	0
Fraiseuse	40	20	4 x I <sub>e</sub>	0

Mise en service rapide  
3RW40 SIRIUS  
démarrreur progressif

1. Contrôle du câblage  
- bloc de commande et  
- bloc de puissance

2. Paramétrage de l'appareil  
**Protection moteur**  
- sur régleur I<sub>e</sub> régler le courant assigné du moteur  
- régler la classe de coupure nécessaire sur le commutateur CLASS.  
**Fonction démarreur progressif**  
- valeur limitation de courant (x I<sub>e</sub>)  
- temps démarrage (s)  
- tension de démarrage (%)  
- temps de ralentissement (s)  
à régler sur les valeurs souhaitées (voir le tableau Proposition de réglage).

3. Contrôler et mettre en circuit les tensions dans le circuit principal et de commande.  
Déterminer et supprimer l'origine du défaut via l'affichage LED et la table des états. (voir Page 10)

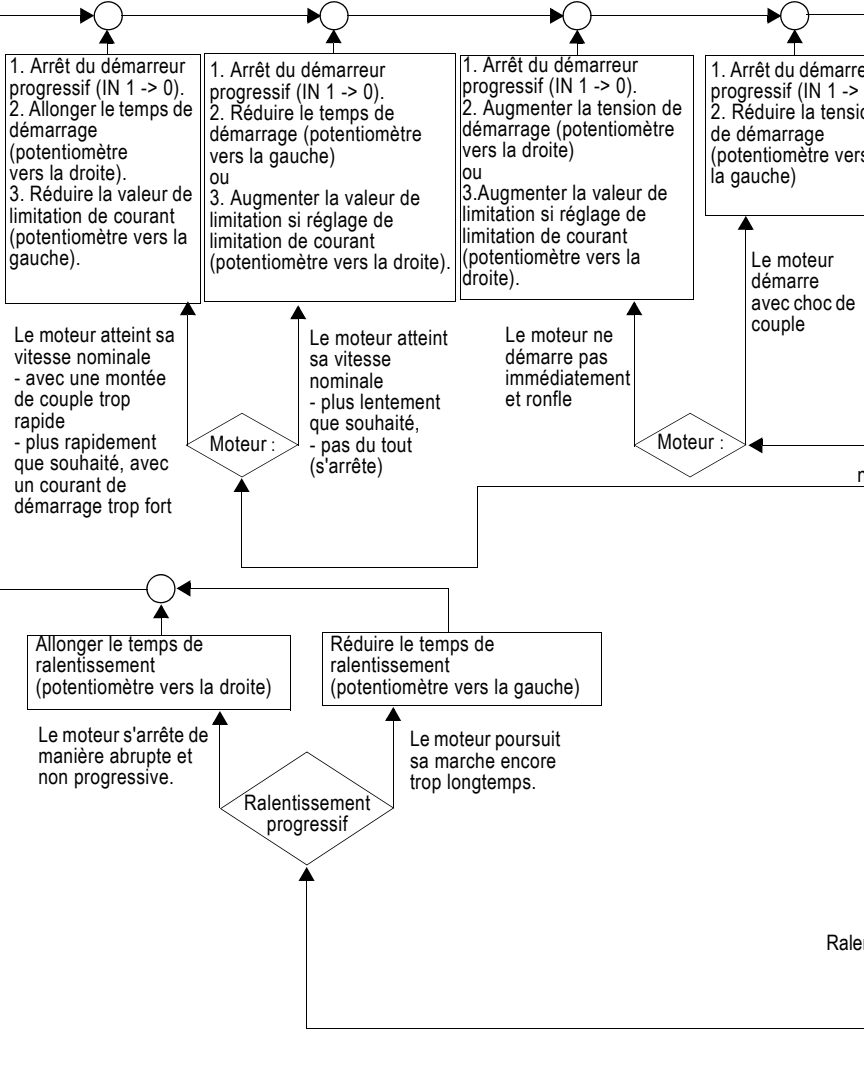
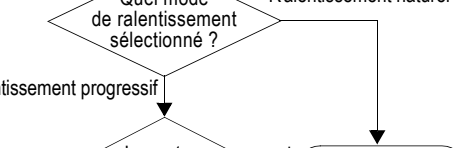
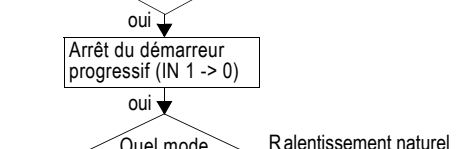
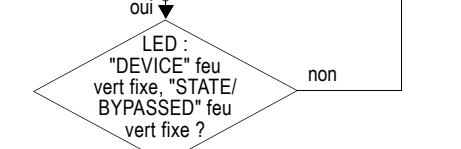
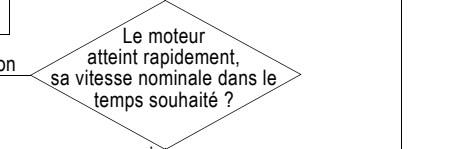
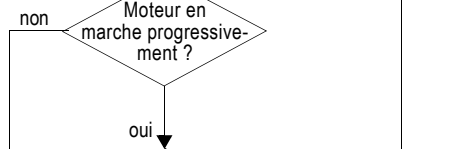
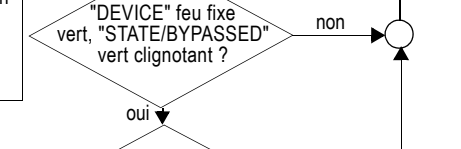
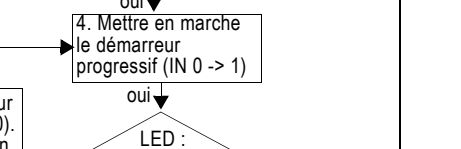
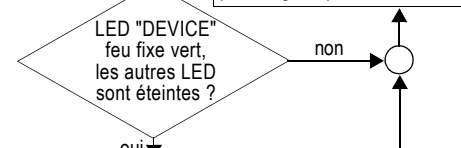

Français

# Vue d'ensemble des affichages

		LED de signalisation 3RW40				Contacts auxiliaires			
		Démarreur progressif		Protection moteur					
3RW40		DEVICÉ (rd/gn/ylw)	STATE / BYPASSED / FAILURE (gn/rd))	OVERLOAD (rd)	RESET MODE (ylw/gn)	13 14 (ON)	13 14 (RUN)	24 23 (BYPASSED)	96 95 98 FAILURE / OVERLOAD
U <sub>c</sub> = 0		●	●	●	●				
Etat de fonctionnement	IN								
Arrêté	0		●	●	●				
Démarrage	1			●	●				
Bypassed	1			●	●				
Ralentissement	0			●	●				
Alarme									
Réglage I <sub>e</sub> /Class incorrect					●				
Démarrage bloqué, appareil trop chaud			●	●	●				
Défauts									
Tension d'alimentation de l'électronique incorrecte		●		●	●				
Réglage I <sub>e</sub> /Class incorrect et IN (0 -> 1)					●				
Coupure du moteur par protection Relais de surcharge / thermistance			●		●				
Protection des moteurs par thermistance Rupture de câble / court-circuit			●		●				
Surcharge thermique appareil				●	●				
- manque de tension de charge - coupure de phase, charge non raccordée				●	●				
Défaut sur l'appareil				●	●				
Fonction de test									
1) Appuyer sur TEST t > 5 s			●		●				
RESET MODE (appuyer pour changer)									
Reset manuel		●	●	●	●				
Reset automatique		●	●	●					
Reset à distance voir la figure 6.2		●	●	●					

Affichage des LED				gn	ylw	rd	1) Test Coupure protection moteur
				= verte	= jaune	= rouge	
éteinte	allumée	clignotante	scintillante				

## ⚠ ATTENTION



### Redémarrage automatique.

#### Peut causer la mort, des lésions graves ou des dommages matériels.

Le réarmement automatique (RESET MODE) ne peut être utilisé dans des applications où le redémarrage inattendu du moteur après le temps de récupération peut provoquer des lésions ou des dommages matériels importants. L'ordre de marche (de l'API par ex.) doit être annulé avant de donner l'ordre de réarmement ; en effet, la présence de l'ordre de marche à la suite du réarmement donne lieu à un redémarrage automatique. Ceci vaut tout particulièrement pour le déclenchement de protection du moteur. Pour des raisons de sécurité, il est recommandé d'intégrer la sortie de signalisation de défauts groupés (bornes 95 et 96) à la commande.

Leer y comprender este instructivo antes de la instalación, operación o mantenimiento del equipo.

	<p><b>PELIGRO</b></p> <p>Tensión peligrosa. Puede causar la muerte o lesiones graves. Desconectar la alimentación eléctrica antes de trabajar en el equipo.</p>	<p><b>PRECAUCIÓN</b></p> <p>El funcionamiento seguro del aparato sólo está garantizado con componentes certificados.</p>
--	---	--

	<p><b>PELIGRO</b></p> <p>Tensión peligrosa. Puede causar la muerte o lesiones graves. Para evitar todo riesgo de electrocución o de quemaduras, no tocar los bornes de la unidad de control del motor mientras estén bajo tensión. Los bornes de salida están bajo tensión aunque la unidad de control del motor esté desconectada.</p>
--	---

**Distancias de montaje para instalación simple (para instalación junto a otros aparatos, ver manual arrancadores suaves)**

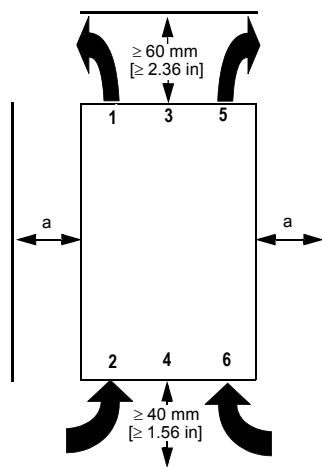

a) 3RW40 2: 15 mm [0.59 in]  
3RW40 3; 3RW40 4: 30 mm [1.18 in]

**ATENCIÓN**

Al instalar el equipo, obsérvese las distancias mínimas indicadas para garantizar la circulación del aire necesario para la refrigeración. La ventilación del equipo se realiza desde abajo hacia arriba.

**PRECAUCIÓN**

**¡Peligro de daños materiales!**  
Preste atención de que no pueda ingresar líquido, polvo o algún objeto conductor al interno del arrancador suave.

**Valores de ajuste de la corriente del motor**

Valores de ajuste admisibles de la corriente del motor en función del tipo CLASS a temperaturas ambiente de 40° C

	$I_e$ [A]	$I_{min}$ [A]	$I_{max}$ [A] CLASS 10	$I_{max}$ [A] CLASS 15	$I_{max}$ [A] CLASS 20
3RW40 24-...	12,5	5	12,5	11	10
3RW40 26-...	25,3	10,3	25,3	23	21
3RW40 27-...	32,2	17,2	32,2	30	27
3RW40 28-...	38	23	38	34	31
3RW40 36-...	45	22,5	45	42	38
3RW40 37-...	63	25,5	63	50	46
3RW40 38-...	72	34,5	72	56	50
3RW40 46-...	80	42,5	80	70	64
3RW40 47-...	106	46	106	84	77

**Programación de la salida ON/RUN 13/14 (ajuste de fábrica: ON) (parte de gráficas, figura 3)**

- Iniciar programación:** (Al usar el equipo 3RW40 2, retire primero la tapa como demostrado en la figura 2.) Mantenga pulsada la tecla " RESET MODE" (2) durante más de 2 s, hasta que el LED "DEVICE" (5) parpadee en verde. Mantenga pulsada la tecla "RESET MODE" (2), pulsando al mismo tiempo la tecla "RESET/TEST" (1) durante más de 1 s, hasta que el LED "DEVICE" (5) del equipo se ilumine rojo.
- Indicar modo:** el LED "STATE/BYPASSED/FAILURE" (6) destella verde: modo ON. El LED "STATE/BYPASSED/FAILURE" (6) parpadea en verde: modo RUN.
- Cambiar modo:** pulse la tecla "RESET MODE" (2).
- Terminar programación y guardar ajustes:** mantenga pulsada la tecla " RESET/TEST" (1) durante más de 1 s, hasta que el LED "DEVICE" (5) se ilumine verde.

# Instrucciones para la puesta en servicio rápida

## Entrada de termistor (sólo 3RW40.-TB0.)

- Conexión Thermoclick según figura 6.3 (quitar ligadura de alambre)
- Conexión PTC de tipo A según figura 6.4 (quitar ligadura de alambre)

### PRECAUCIÓN

**¡Peligro de daños materiales!**

No está admitida la conexión con bornes no ocupados.

Parámetros recomendados	Parámetros de arranque			Parámetros de parada
Aplicación	Tensión de arranque %	Tiempo de arranque s	Valor límite de corriente	Tiempo de parada s
Cinta transportadora	70	10	$5 \times I_e$	5
Transportador a rodillos	60	10	$5 \times I_e$	5
Compresor	50	10	$4 \times I_e$	0
Ventilador pequeño	40	10	$4 \times I_e$	0
Bomba	40	10	$4 \times I_e$	10
Bomba hidráulica	40	10	$4 \times I_e$	0
Mezcladora	40	20	$4 \times I_e$	0
Máquina fresadora	40	20	$4 \times I_e$	0

Puesta en servicio rápida  
3RW40 SIRIUS  
Arrancador suave

1. Control del cableado  
- parte de control y  
- parte de potencia

2. Parametrizar el equipo  
Protección del motor  
- ajustar la corriente nominal del motor mediante el ajustador  $I_e$   
- seleccionar la clase de disparo mediante el selector CLASS  
Función de arranque suave  
- Valor límite de corriente ( $\times I_e$ )  
- Tiempo de arranque (s)  
- Tensión de arranque (%)  
- Tiempo de parada (s)  
ajustar los valores deseados (ver tabla Parámetros recomendados).

3. Controlar y aplicar tensiones en el circuito de mando y en el circuito principal.

Determinar y eliminar la causa del fallo mediante el indicador LED y la tabla de estado. (ver Página 13)

LED "DEVICE" luz verde permanente, ¿están apagados los demás LEDs?

4. Activar el arrancador suave (IN 0 -> 1)

LEDs: "DEVICE" luz verde permanente, "STATE/BYPASSED" ¿destella en verde?

¿arranca el motor suavemente?

¿El motor alcanza rápidamente, dentro del tiempo deseado, su velocidad nominal?

LEDs: ¿"DEVICE" luz verde permanente, "STATE/BYPASSED" luz verde permanente?

Desactivar el arrancador suave (IN 1 -> 0)

¿Cuál es el tipo de deceleración seleccionado?

¿Para el motor como deseado?

Puesta en servicio finalizada

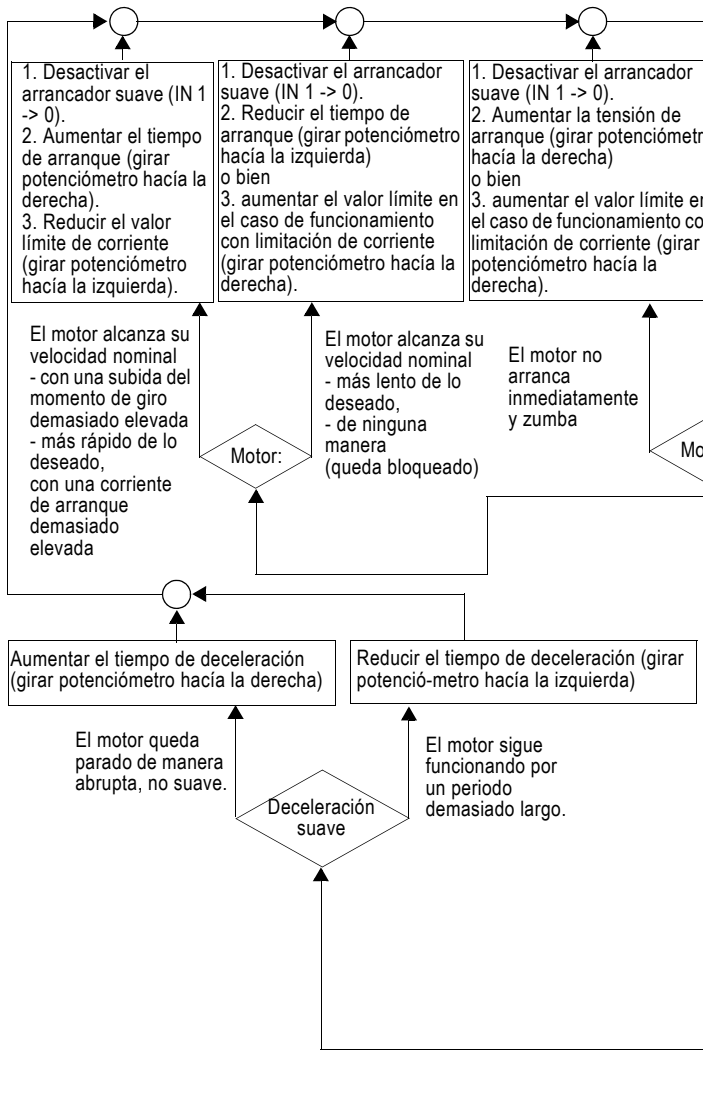

## Resumen de las indicaciones

		Indicadores LED 3RW40				Contactos auxiliares			
		Arrancador suave		Protección del motor					
3RW40		DEVICE (rd/gn/yw)	STATE / BYPASSED / FAILURE (gn/rd)	OVERLOAD (rd)	RESET MODE (ylw/gn)	13 14 (ON)	13 14 (RUN)	24 23 (BYPASSED)	96 95 98 FAILURE / OVERLOAD
$U_s = 0$		●	●	●	●				
Estado operativo	IN								
Desconectado	0	gn	●	●	●				
Arranque	1	gn	gn	●	●				
Bypassed	1	gn	gn	●	●				
Deceleración	0	gn	gn	●	●				
Alarma									
Ajuste $I_e$ /Class inadmisibles		gn	gn  gn		●				
Arranque bloqueado, sobrecalentamiento del equipo		ylw	●	●	●				
Fallo									
Tensión de alimentación de la electrónica inadmisibles		●	rd	●	●				
Ajuste $I_e$ /Class inadmisibles e IN (0 -> 1)		gn	rd		●				
Desconexión protección del motor Relé de sobrecarga / termistor		gn	●		●				
Protección del motor del termistor Rotura de cable / cortocircuito		gn	●		●				
Sobrecarga térmica del equipo		ylw	rd	●	●				
- Falta tensión de carga - Corte de fase, falta carga		gn	rd	●	●				
Fallo del equipo		rd	rd	●	●				
Función de prueba									
<sup>1)</sup> Pulsar TEST t > 5 s		gn	●	rd	●				
RESET MODE (pulsar para cambiar)									
Reset manual		●	●	●	●				
Reset automático		●	●	●	ylw				
Reset remoto ver figura 6.2		●	●	●	gn				

Indicación de los LEDs							<sup>1)</sup> Test desconexión protección motor
				gn = verde	ylw = amarillo	rd = rojo	
Apagado	Encendido	Intermitente	Centelleante				

### ⚠ ADVERTENCIA



#### Rearranque automático.

**Puede causar la muerte, lesiones graves o daños materiales.**

No está permitido utilizar el modo automático de Reset (RESET MODE) en aplicaciones en las cuales el rearmado imprevisto después del tiempo de recuperación pueda provocar lesiones físicas o daños materiales. La orden de marcha (p. ej. por medio de la PLC) deberá anularse antes de una orden de rearme; en efecto, la presencia de la orden de marcha después de la orden de rearme provoca un rearmado automático. Esto es especialmente válido para el disparo de protección del motor. Por razones de seguridad se recomienda integrar la salida de señalización de fallo agrupado (bornes 95 y 96) en la unidad de control.

Leggere con attenzione queste istruzioni prima di installare, utilizzare o eseguire manutenzione su questa apparecchiatura.

**PERICOLO**

**Tensione pericolosa. Può provocare morte o lesioni gravi.**  
Scollegare l'alimentazione prima di eseguire interventi sull'apparecchiatura.

**CAUTELA**

Il funzionamento sicuro dell'apparecchiatura è garantito soltanto con componenti certificati.

**PERICOLO**

**Tensione pericolosa. Può provocare morte o lesioni gravi.**  
Per evitare folgorazioni o ustioni, i morsetti dell'avviatore non devono essere toccati quando l'apparecchiatura è sotto tensione. I morsetti di uscita sono sotto tensione anche quando l'avviatore è disinserito.

**Distanze di montaggio nell'installazione singola (per l'installazione compatta vedi manuale avviatore dolce)**

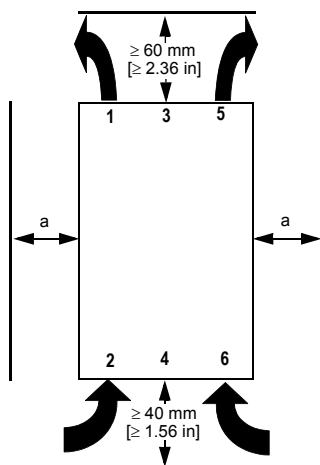

**ATTENZIONE**

Durante il montaggio osservare le distanze indicate per consentire una circolazione sufficiente di aria di raffreddamento. L'apparecchio viene ventilato dal basso verso l'alto.

**CAUTELA**

**Pericolo di danni alle cose.**  
Evitare che liquidi, polvere o altri conduttori finiscano nell'avviatore dolce.

a) 3RW40 2: 15 mm [0.59 in]  
3RW40 3; 3RW40 4: 30 mm [1.18 in]

**Valori di impostazione della corrente motore**

Valori di impostazione della corrente motore a seconda del tipo di CLASS a 40° C temperatura ambiente

	$I_e$ [A]	$I_{min}$ [A]	$I_{max}$ [A] CLASS 10	$I_{max}$ [A] CLASS 15	$I_{max}$ [A] CLASS 20
3RW40 24-...	12,5	5	12,5	11	10
3RW40 26-...	25,3	10,3	25,3	23	21
3RW40 27-...	32,2	17,2	32,2	30	27
3RW40 28-...	38	23	38	34	31
3RW40 36-...	45	22,5	45	42	38
3RW40 37-...	63	25,5	63	50	46
3RW40 38-...	72	34,5	72	56	50
3RW40 46-...	80	42,5	80	70	64
3RW40 47-...	106	46	106	84	77

**Programmazione dell'uscita ON/RUN 13/14 (impostazione di fabbrica: ON) (grafiche, figura 3)**

- Avvio della programmazione:** (nell'apparecchio 3RW40 2, rimuovere prima la copertura come indicato nella Figura 2.) Tenere premuto il tasto "RESET MODE" (2) per più di 2 secondi. Il LED "DEVICE" (5) verde sfarfalla. Tenere premuto il tasto "RESET MODE" (2) e premere allo stesso tempo il tasto "RESET/TEST" (1) per più di 1 secondo. Il LED "DEVICE" (5) rosso dell'apparecchio si illumina.
- Indicazione del modo:** il LED "STATE/BYPASSED/FAILURE" (6) lampeggia verde: modo ON. Il LED "STATE/BYPASSED/FAILURE" (6) sfarfalla verde: modo RUN.
- Cambio del modo:** premere il tasto "RESET MODE" (2).
- Fine della programmazione e salvataggio delle impostazioni:** tenere premuto il tasto "RESET/TEST" (1) per più di 1 secondo. Il LED "DEVICE" (5) verde illumina.

Italiano

# Istruzioni per messa in servizio rapida

## Collegamento termistore (solo 3RW40.-TB0.)

- Collegamento Thermoclick secondo Figura 6.3 (rimuovere ponte di filo)
- Collegamento PTC tipo A secondo Figura 6.4 (rimuovere ponte di filo)

### CAUTELA

**Pericolo di danni alle cose.**  
Non è ammesso il collegamento a morsetti non assegnati.

Consiglio di installazione	Avvio parametri			Arresto parametri
Applicazione	Tensione di avviamento %	Tempo di avviamento s	Valore di limitazione di corrente	Tempo di arresto s
Nastro trasportatore	70	10	$5 \times I_e$	5
Trasportatore a rulli	60	10	$5 \times I_e$	5
Compressore	50	10	$4 \times I_e$	0
Piccolo ventilatore	40	10	$4 \times I_e$	0
Pompa	40	10	$4 \times I_e$	10
Pompa idraulica	40	10	$4 \times I_e$	0
Mescolatore	40	20	$4 \times I_e$	0
Fresatrice	40	20	$4 \times I_e$	0

Messa in servizio rapida  
3RW40 SIRIUS  
Avviatore dolce

1. Controllo del cablaggio
  - Elemento di comando e
  - Elemento di potenza

2. Parametrizzazione dell'apparecchio
    - Protezione motore**
      - impostare al regolatore  $I_e$  la corrente nominale del motore dell'azionamento
      - impostare all'interruttore CLASS la classe di intervento necessaria.
    - Funzione di avvio dolce**
      - Valore di limitazione della corrente ( $\times I_e$ )
      - Tempo di avvio (s)
      - Tensione d'avvio (%)
      - Tempo di arresto (s)
- impostare sui valori desiderati (vedi tabella consigli di installazione).

3. Verificare e inserire le tensioni nel circuito di controllo e in quello principale.
  - Individuare e risolvere la causa dell'errore tramite indicatore LED e diagramma di stato (vedi Pagina 16.)

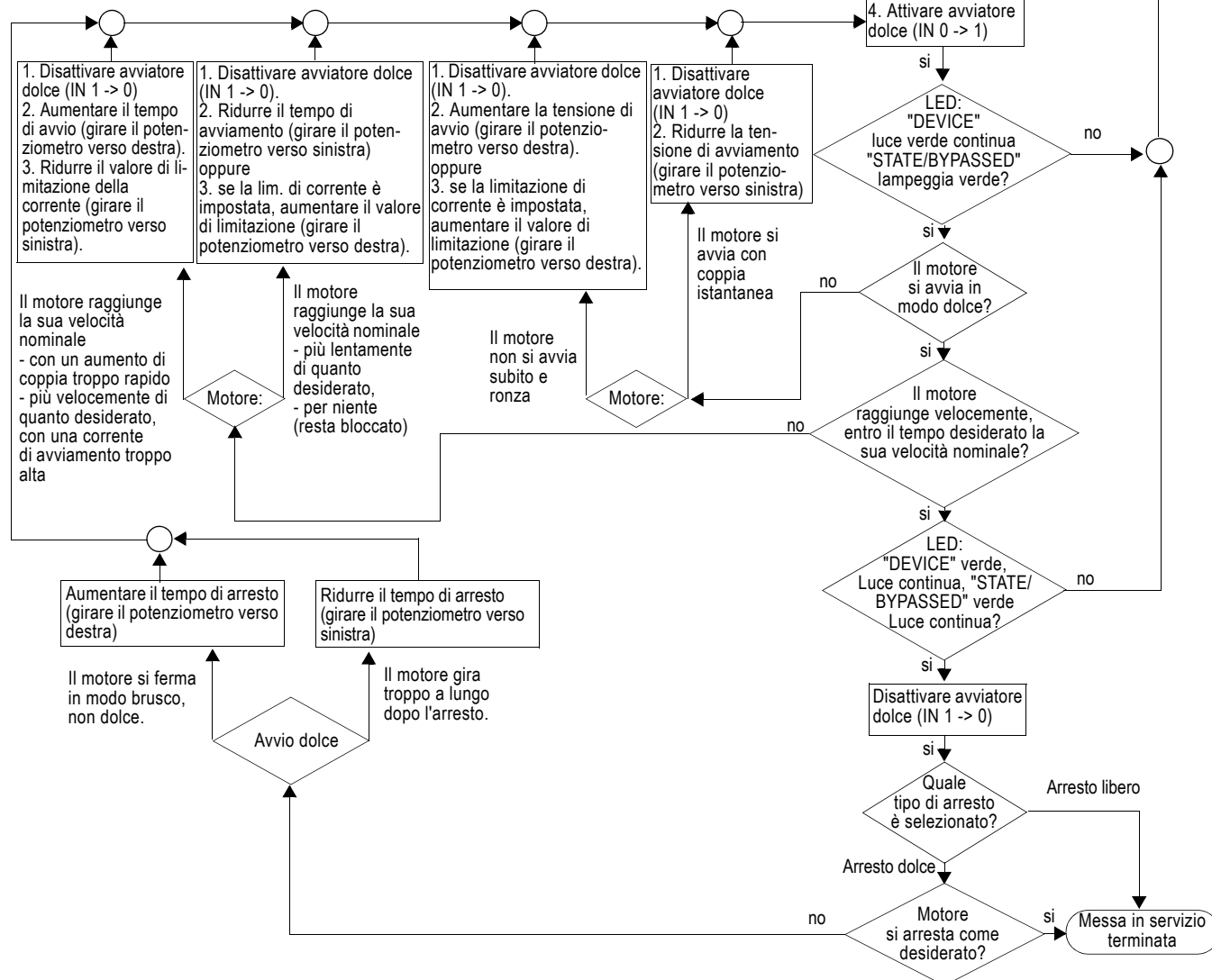

Italiano

## Elenco delle visualizzazioni

		LED di segnalazione 3RW40				Contatti ausiliari			
		Avviatore dolce		Protezione motore					
3RW40		DEVICE (rd/gn/ylw)	STATE / BYPASSED / FAILURE (gn/rd)	OVERLOAD (rd)	RESET MODE (ylw/gn)	13 14 (ON)	13 14 (RUN)	24 23 (BYPASSED)	96 95 98 FAILURE / OVERLOAD
U <sub>s</sub> = 0		●	●	●	●				
Stato operativo	IN								
OFF	0	gn	●	●	●				
Avviamento	1	gn	gn	●	●				
Bypassed	1	gn	gn	●	●				
Decelerazione	0	gn	gn	●	●				
Allarme									
Impostazione I <sub>e</sub> /Class non ammessa		gn	gn	gn	●				
Avvio bloccato, apparecchiatura troppo calda		ylw	●	●	●				
Errore									
Tensione di alimentazione dell'elettronica non ammessa		●	rd	●	●				
Impostazione I <sub>e</sub> /Class non ammessa e IN (0 -> 1)		gn	rd		●				
Disinserzione protezione motore Relè di sovraccarico / termistore		gn	●		●				
Protezione motore a termistore Rottura del cavo / Cortocircuito		gn	●		●				
Sovraccarico termico apparecchiatura		ylw	rd	●	●				
- Tensione di carico assente - Caduta di fase, carico mancante		gn	rd	●	●				
Guasto dell'apparecchio		rd	rd	●	●				
Funzione test									
1) Premere TEST t > 5 s		gn	●	rd	●				
RESET MODE (premere per cambiare)									
Reset manuale		●	●	●	●				
Reset automatico		●	●	●	ylw				
Reset remoto vedi Figura 6.2		●	●	●	gn				

Indicazione dei LED							1) Test della disinserzione di protezione motore
				gn =	ylw =	rd =	
OFF	ON	lampeggiante	sfarfallante	verde	giallo	rosso	

### ⚠ AVVERTENZA



#### Riavvio automatico.

**Può causare morte, gravi danni alle persone o danni alle cose.**

Il modo di reset automatico (RESET MODE) non deve essere utilizzato in applicazioni nelle quali il riavvio inaspettato del motore dopo la scadenza del tempo di riattivazione può causare danni alle persone o alle cose.

Il comando di avvio (ad es. tramite il PLC) deve essere ripristinato prima di un comando di reset, dato che, in caso di comando d'avviamento imminente, dopo il comando di reset si verifica un ulteriore riavvio automatico. Ciò vale in particolar modo per lo sgancio di protezione motore. Per motivi di sicurezza si consiglia di includere l'uscita errore complessivo (morsetti 95 e 96) nel controllore.



Ler e compreender estas instruções antes da instalação, operação ou manutenção do equipamento.

**PERIGO**



**Tensão perigosa.**  
Perigo de morte ou ferimentos graves.  
Desligue a corrente antes de trabalhar no equipamento.

**CUIDADO**

O funcionamento seguro do aparelho apenas pode ser garantido se forem utilizados componentes certificados.

**PERIGO**



**Tensão perigosa.**  
Perigo de morte ou ferimentos graves.  
Para evitar choque elétrico ou queimaduras, não podem ser tocados os bornes do aparelho de comando do motor quando este estiver sob tensão. Os bornes de saída também estão sob tensão quando o aparelho de comando do motor estiver desligado.

**CUIDADO**

O funcionamento seguro do aparelho apenas pode ser garantido se forem utilizados componentes certificados.

**Distâncias na montagem individual (montagem junto a outros aparelhos, veja o manual do softstarter)**

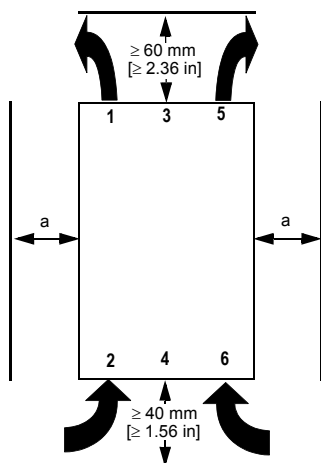

**ATENÇÃO**

Considere as distâncias indicadas na montagem do aparelho para que possa circular suficiente ar para a refrigeração. O aparelho é ventilado de baixo para cima.

**CUIDADO**

**Risco de danos materiais.**  
Tomar o devido cuidado para que não penetre nenhum líquido, pó ou objeto condutivo na chave de partida suave.

a) 3RW40 2: 15 mm [0.59 in]  
3RW40 3; 3RW40 4: 30 mm [1.18 in]

**Valores de ajuste da corrente do motor**

Valores de ajuste da corrente do motor permitidos dependendo do ajuste da CLASS em temperatura ambiente de 40°C

	$I_e$ [A]	$I_{min}$ [A]	$I_{máx}$ [A] CLASS 10	$I_{máx}$ [A] CLASS 15	$I_{máx}$ [A] CLASS 20
3RW40 24-...	12,5	5	12,5	11	10
3RW40 26-...	25,3	10,3	25,3	23	21
3RW40 27-...	32,2	17,2	32,2	30	27
3RW40 28-...	38	23	38	34	31
3RW40 36-...	45	22,5	45	42	38
3RW40 37-...	63	25,5	63	50	46
3RW40 38-...	72	34,5	72	56	50
3RW40 46-...	80	42,5	80	70	64
3RW40 47-...	106	46	106	84	77

**Programação da saída 13/14 ON/RUN (Ajuste feito na fábrica: ON) (parte do gráfico, figura 3)**

- Iniciar a programação:** (retirar a tampa do equipamento 3RW40 2, conforme mostrado na figura 2.) Pressionar a tecla "RESET MODE" (2) por mais de 2 s, até que o LED "DEVICE" (5) cintile em verde. Manter a tecla "RESET MODE" (2) pressionada e, simultaneamente, pressionar a tecla "RESET/TEST" (1) por mais de 1 s, até que o LED "DEVICE" (5) acenda em vermelho no equipamento.
- Exibir o modo:** o LED "STATE/BYPASSED/FAILURE" (6) pisca em verde: modo ON. LED "STATE/BYPASSED/FAILURE" (6) cintila em verde: modo RUN.
- Mudar o modo:** pressionar a tecla "RESET MODE" (2).
- Finalizar a programação e salvar os ajustes:** pressionar a tecla "RESET/TEST" (1) por mais de 1 s, até que o LED "DEVICE" (5) acenda em verde.

# Instrução para a colocação em funcionamento rápida

## Conexão do termistor (somente 3RW40.-TB0.)

- Conexão termoclick conforme figura 6.3 (retirar fio de ponte)
- Conexão PTC tipo A conforme figura 6.4 (retirar fio de ponte)

### CUIDADO

#### Risco de danos materiais.

Não é permitida a conexão a bornes não ocupados.

Sugestão de ajuste	Parâmetros de partida			Parâmetros de parada
	Tensão inicial %	Tempo de partida s	Valor limitador de corrente	Tempo de parada s
Aplicação				
Correia transportadora	70	10	5 x I <sub>e</sub>	5
Transportador de rolos	60	10	5 x I <sub>e</sub>	5
Compressor	50	10	4 x I <sub>e</sub>	0
Ventilador pequeno	40	10	4 x I <sub>e</sub>	0
Bomba	40	10	4 x I <sub>e</sub>	10
Bomba hidráulica	40	10	4 x I <sub>e</sub>	0
Agitador	40	20	4 x I <sub>e</sub>	0
Fresadora	40	20	4 x I <sub>e</sub>	0

Colocação em funcionamento rápida da chave de partida suave 3RW40 SIRIUS

1. Controle da fiação  
- parte de comando e  
- parte de potência

2. Parametrizar o aparelho  
**Proteção do motor**  
- ajustar a corrente nominal de motor do acionamento no ajustador I<sub>e</sub>  
- ajustar a classe de desligamento necessária no interruptor CLASS.  
**Função da chave de partida suave**  
- Valor limitador de corrente (x I<sub>e</sub>)  
- Tempo de partida (s)  
- Tensão inicial (%)  
- Tempo de parada (s)  
ajustar os valores desejados (veja a tabela Sugestão de ajuste).

3. Verificar e conectar as tensões no circuito de corrente de comando e principal. Apurar e eliminar a causa da falha através da indicação LED e tabela de estado. (veja Página 19)

LED "DEVICE" luz contínua verde, os outros LEDs estão desligados?

4. Ligar a chave de partida suave (IN 0 -> 1)

LEDs: "DEVICE" luz contínua verde, "STATE/BYPASSED" pisca em verde?

O motor parte suavemente?

Motor alcança rapidamente sua velocidade de rotação nominal dentro do tempo desejado?

LEDs: "DEVICE" luz contínua verde, "STATE/BYPASSED" luz contínua verde?

Desligar a chave de partida suave (IN 1 -> 0)

Qual foi o tipo de parada selecionado?

Parada suave

Motor alcança a parada desejada?

Colocação em funcionamento finalizada

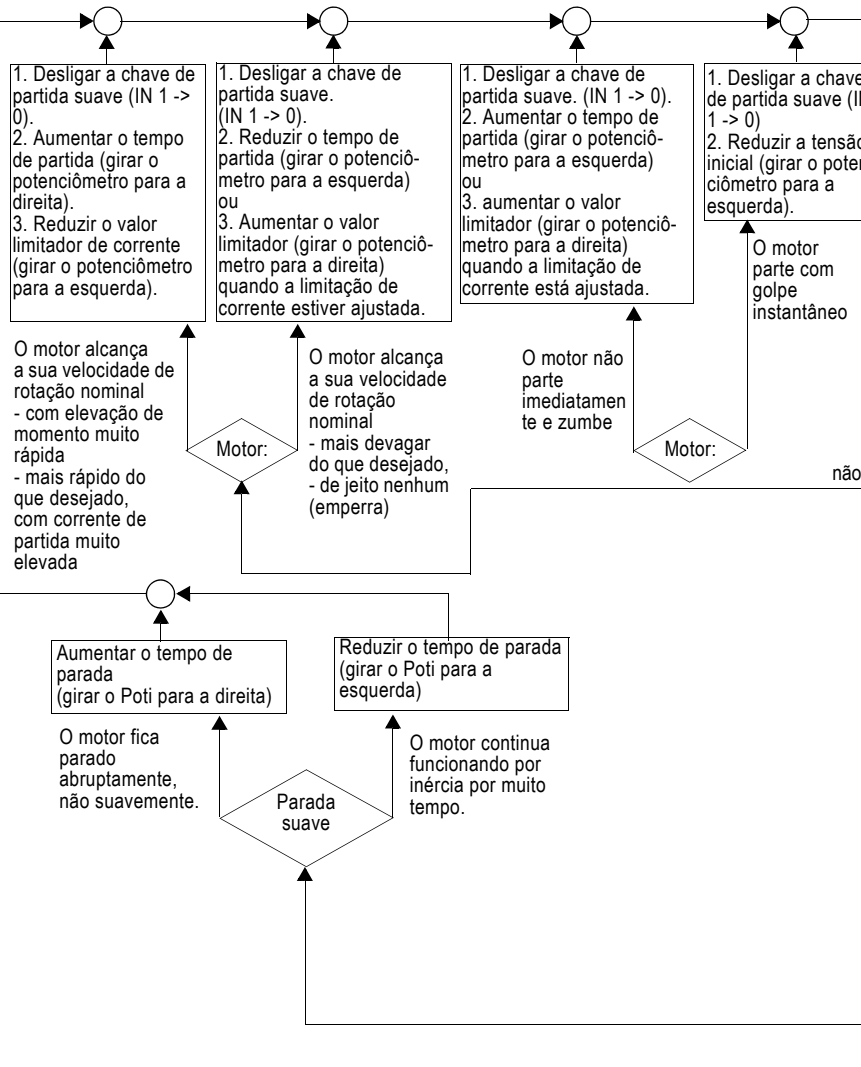

Português

## Sinóptico de indicações

		Indicadores LED 3RW40				Contatos auxiliares			
		Chave de partida suave		Proteção do motor					
3RW40		DEVICE (rd/gn/ylw)	STATE / BYPASSED / FAILURE (gn/rd))	OVERLOAD (rd)	RESET MODE (ylw/gn)	13 14 (ON)	13 14 (RUN)	24 23 (BYPASSED)	96 95 98 FAILURE / OVERLOAD
U <sub>s</sub> = 0		●	●	●	●				
Estado operacional	IN								
Desligado	0	gn	●	●	●				
Partida	1	gn	gn	●	●				
Bypassed	1	gn	gn	●	●				
Parada por inércia	0	gn	gn	●	●				
Advertência									
Ajuste I <sub>e</sub> /class não permissível		gn	gn		●				
Partida bloqueada, equip. muito quente		ylw	●	●	●				
Falha									
Tensão de alimentação do sistema eletrônico não permissível		●	rd	●	●				
Ajuste I <sub>e</sub> /Class não permissível e IN (0 -> 1)		gn	rd		●				
Desativação de proteção do motor Relé de sobrecarga / termistor		gn	●		●				
Proteção do motor por termistor Ruptura do fio / curto-circuito		gn	●		●				
Sobrecarga térmica do equipamento		ylw	rd	●	●				
- Falta tensão de carga - Falha de fase, falta de carga		gn	rd	●	●				
Falha do equipamento		rd	rd	●	●				
Função de teste									
<sup>1)</sup> Pressionar TEST t > 5 s		gn	●	rd	●				
RESET MODE (pressionar para mudar)									
Reset manual		●	●	●	●				
Reset automático		●	●	●	ylw				
Reset remoto veja figura 6.2		●	●	●	gn				
Indicação dos LEDs									
				gn =	ylw =	rd =	<sup>1)</sup> Teste da desativação de proteção do motor		
Desligado	Ligado	Piscando	Cintilante	verde	amarelo	vermelho			

### ⚠ AVISO



#### Reativação automática.

**Pode provocar morte, graves lesões corporais ou graves danos materiais.**

O modo de reset automático não deve ser usado em aplicações, nas quais uma reativação inesperada do motor possa causar ferimentos e danos materiais.

O comando de partida (p. ex. PLC) deve ser reposicionado antes de um comando de reset, uma vez que com um comando de partida em andamento, após o comando de reset, ocorre automaticamente uma nova reativação. Isto vale em especial no disparo da proteção do motor. Por motivos de segurança recomenda-se incluir a saída de falha coletiva (bornes 95 e 96) no comando.

Cihazın kurulumundan, çalıştırılmasından veya bakıma tabi tutulmasından önce, bu kılavuz okunmuş ve anlaşılmış olmalıdır.

	<p><b>⚠ TEHLİKE</b></p> <p><b>Tehlikeli gerilim.</b>  <b>Ölüm tehlikesi veya ağır yaralanma tehlikesi.</b>          Çalışmalara başlamadan önce, sistemin ve cihazın gerilim beslemesini kapatınız.</p>	<p><b>ÖNEMLİ DİKKAT</b></p> <p>Cihazın güvenli çalışması ancak sertifikalı bileşenler kullanılması halinde garanti edilebilir.</p>
	<p><b>⚠ TEHLİKE</b></p> <p><b>Tehlikeli gerilim.</b>  <b>Ölüm tehlikesi veya ağır yaralanma tehlikesi.</b>          Cihaz gerilim beslemesi altında iken, elektrik çarpmasından veya yanıklardan sakınmak için, motor kontrol cihazının kışaklarıyla temas edilmemelidir. Motor kontrol cihazı KAPALI halde iken de çıkış kışaklarında gerilim mevcuttur.</p>	

### Tek tek kurulumda montaj mesafeleri (Sıkı kurulum bkz. Yumuşak yol verici kullanım kılavuzu)

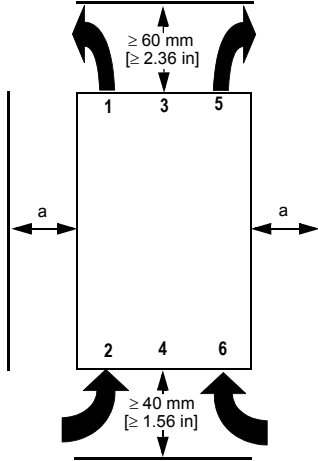

a) 3RW40 2: 15 mm [0.59 in]  
 3RW40 3; 3RW40 4: 30 mm [1.18 in]

### DİKKAT

Soğutma için yeterli derecede hava sirkülasyonunun sağlanması amacıyla cihazı monte ederken belirtilen mesafelere riayet ediniz. Cihaz, aşağıdan yukarıya doğru havalandırılmaktadır.

### ÖNEMLİ DİKKAT

**Maddi hasar tehlikesi.**  
 Yumuşak yol vericiye sıvı, toz veya herhangi bir cisim kaçmamasına dikkat ediniz.

### Motor akımı ayar değerleri

CLASS ayarına bağlı olarak izin verilen motor akımı ayar değerleri 40° C ortam ısısında

	$I_e$ [A]	$I_{asg}$ [A]	$I_{azm}$ [A] CLASS 10	$I_{azm}$ [A] CLASS 15	$I_{azm}$ [A] CLASS 20
3RW40 24-...	12,5	5	12,5	11	10
3RW40 26-...	25,3	10,3	25,3	23	21
3RW40 27-...	32,2	17,2	32,2	30	27
3RW40 28-...	38	23	38	34	31
3RW40 36-...	45	22,5	45	42	38
3RW40 37-...	63	25,5	63	50	46
3RW40 38-...	72	34,5	72	56	50
3RW40 46-...	80	42,5	80	70	64
3RW40 47-...	106	46	106	84	77

### 13/14 ON/RUN çıkışının programlanması (Fabrika ayarı: ON) (Grafik bölümü, Resim 3)

- Programlamayı başlatınız:** (3RW40 2 cihazında kapağı Resim 2'de gösterildiği şekilde çıkarınız.) "RESET MODE" (2) tuşuna LED "DEVICE" (5) yeşil renkte titrek yanana kadar 2 saniyeden uzun süre basınız. "RESET MODE" (2) tuşunu basılı tutunuz ve aynı zamanda cihazdaki LED "DEVICE" (5) kırmızı yanana kadar "RESET/TEST" (1) tuşuna 1 saniyeden daha uzun süreyle basınız.
- Modun gösterilmesi:** LED "STATE/BYPASSED/FAILURE" (6) yeşil yanıp söner: ON Modu. LED "STATE/BYPASSED/FAILURE" (6) yeşil renkte titrek yanar: RUN Modu.
- Modun değiştirilmesi:** "RESET MODE" (2) tuşuna basınız.
- Programlamanın bitirilmesi ve ayarların hafızaya alınması:** "RESET/TEST" (1) tuşuna LED "DEVICE" (5) yeşil yanana kadar 1 saniyeden uzun süre basınız.



## Gösterge tablosu

		LED göstergeleri 3RW40				Yardımcı kontaklar			
		Yumuşak yol verici		Motor koruma		13 14 (ON)		24 23 (BYPASSED)	
3RW40		DEVICE (rd/gn/ylw)	STATE / BYPASSED / FAILURE (gn/rd)	OVERLOAD (rd)	RESET MODE (ylw/gn)	13 14 (ON)	13 14 (RUN)	24 23 (BYPASSED)	96 95 98 FAILURE / OVERLOAD
$U_s = 0$		●	●	●	●				
İşletme durumu	IN								
Kapalı	0		●	●	●				
Yol verme	1			●	●				
Bypassed	1			●	●				
Durma	0			●	●				
Uyarı									
$I_g$ /Class ayarı kabul edilmiyor					●				
Start bloke edildi, cihaz çok sıcak			●	●	●				
Arıza									
Tedarik gerilimi Elektronik kabul edilmiyor		●		●	●				
Kabul edilmeyen $I_g$ /Class ayarı ve IN (0 -> 1)					●				
Motor koruma kapaması Aşırı yük rölesi / Termistör			●		●				
Termistör motor koruması Tel kırılması / Kısa devre			●		●				
Cihazda termik aşırı yük				●	●				
- Yük gerilimi yok - Faz kesilmesi, eksik yük				●	●				
Cihaz hatası				●	●				
Test fonksiyonu									
<sup>1)</sup> TEST t > 5 sn basınız			●		●				
RESET MODE (Değiştirmek için basılır)									
Manüel reset		●	●	●	●				
Otomatik reset		●	●	●					
Uzaktan reset Resim 6.2		●	●	●					

LED göstergeleri				gn	ylw	rd	1) Test Motor koruma kapaması
				= yeşil	= sarı	= kırmızı	
kapalı	açık	yanıp söner	titrer				

### UYARI



#### Otomatik olarak yeniden çalışma.

#### Ölüme, ağır yaralanmalara veya maddi hasara yol açabilir.

Otomatik sıfırlama modu (RESET MODE), motorun yeniden işleme hazır duruma gelme süresinin bitiminden sonra beklenmedik biçimde yeniden start almasının, yaralanma ya da maddi hasara yol açabileceği durumlarda kullanılmaz.

Start komutu (örn. SPS ile) reset komutundan önce verilmelidir, çünkü reset komutundan sonra verilecek bir start komutunda otomatik olarak yeniden ve kendiliğinden bir start alma durumu ortaya çıkar. Bu özellik de motor koruma tertibatının salıverilmesi için geçerlidir. Emniyet nedeniyle toplu hata çıkışının (95 ve 96 kısaçları) kumandaya bağlanması tavsiye edilir.

Перед установкой, вводом в эксплуатацию или обслуживанием устройства необходимо прочесть и понять данное руководство.

**ОПАСНО**

**Опасное напряжение. Опасность для жизни или возможность тяжелых травм.**  
Перед началом работ отключить подачу питания к установке и к устройству.

**ОСТОРОЖНО**

Безопасность работы устройства гарантировано только при использовании сертифицированных компонентов.

**ОПАСНО**

**Опасное напряжение. Опасность для жизни или риск получения травм.**  
Во избежание получения электрического удара или сильного ожога нельзя прикасаться к клеммам устройства управления двигателем, когда устройство находится под напряжением. На выходных клеммах имеется напряжение, даже если устройство управления двигателем находится в выключенном состоянии.

**ОСТОРОЖНО**

**Монтажное расстояние (расположение плотно друг к другу см. системное руководство для устройства плавного пуска)**

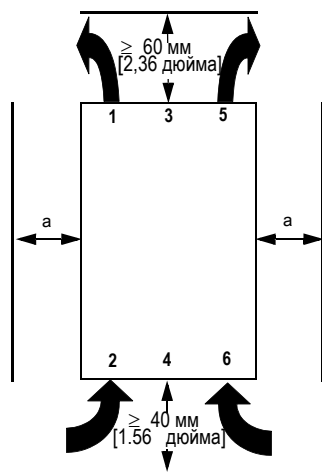

**ВНИМАНИЕ**

Учитывайте при монтаже устройства указанные расстояния, для обеспечения возможности циркулирования достаточного количества воздуха, необходимого для охлаждения. Охлаждающий воздух в устройстве движется снизу вверх.

**ОСТОРОЖНО**

**Опасность материального ущерба.**  
Следите, чтобы в устройство плавного пуска не попадали жидкость, пыль или проводящий предмет.

а) 3RW40 2: 15 мм [0,59 дюйма]  
3RW40 3; 3RW40 4: 30 мм [1,18 дюйма]

**Установленные значения тока двигателя**

Допустимые установленные значения токов двигателя в зависимости от настройки CLASS при температуре окружающей среды 40° C

	$I_e$ [A]	$I_{мин}$ [A]	$I_{макс}$ [A] CLASS 10	$I_{макс}$ [A] CLASS 15	$I_{макс}$ [A] CLASS 20
3RW40 24-...	12,5	5	12,5	11	10
3RW40 26-...	25,3	10,3	25,3	23	21
3RW40 27-...	32,2	17,2	32,2	30	27
3RW40 28-...	38	23	38	34	31
3RW40 36-...	45	22,5	45	42	38
3RW40 37-...	63	25,5	63	50	46
3RW40 38-...	72	34,5	72	56	50
3RW40 46-...	80	42,5	80	70	64
3RW40 47-...	106	46	106	84	77

**Программирование выхода ON/RUN, клеммы 13/14 (заводская настройка: ON) (графическая часть, рис. 3)**

- Начать программирование:** (В устройстве 3RW40 2 снять крышку, как это показано на рис. 2). Держите кнопку "RESET MODE" ("СБРОС РЕЖИМА") (2) нажатой дольше 2 секунд до тех пор, пока светодиод "DEVICE" ("УСТРОЙСТВО") (5) не начнёт мерцать зеленым светом. Держите кнопку "RESET MODE" (2) нажатой и одновременно нажмите кнопку "RESET/TEST" ("СБРОС/ТЕСТ") (1) дольше 1 с, пока светодиод "DEVICE" (5) на устройстве не начнёт светиться красным светом.
- Показать режим:** Светодиод "STATE/BYPASSED/FAILURE" ("СОСТОЯНИЕ/БАЙПАС/ОШИБКА") (6) мигает зеленым светом: Режим ON. Светодиод "STATE/BYPASSED/FAILURE" (6) мигает зеленым светом: Режим RUN (РАБОТА).
- Поменять режим:** Нажать кнопку "RESET MODE" ("СБРОС РЕЖИМА") (2)
- Завершить программирование и сохранить настройки:** Держите кнопку "RESET/TEST" ("СБРОС/ТЕСТ") (1) дольше 1 с до тех пор, пока светодиод "DEVICE" (5) не начнёт светиться зеленым светом.

# Руководство для быстрого запуска в эксплуатацию

## Подключение термистора (только для 3RW40.-TB0.)

- Подключение Thermoslicк в соответствии с рис. 6.3 (удалить проволочную перемычку)
- Подключение термистора PTC типа А в соответствии с рис. 6.4 (удалить проволочную перемычку)

### ОСТОРОЖНО

**Опасность материального ущерба.**  
Подключение к свободным клеммам не допустимо.

Предложение по настройке	Параметры пуска			Параметры выбега
Применение	Начальное напряжение %	Время пуска, с	Параметр ограничения тока	Время выбега, с
Ленточный конвейер	70	10	$5 \times I_e$	5
Роликовый конвейер	60	10	$5 \times I_e$	5
Компрессор	50	10	$4 \times I_e$	0
Мал. вентилятор	40	10	$4 \times I_e$	0
Насос	40	10	$4 \times I_e$	10
Гидравлический насос	40	10	$4 \times I_e$	0
Мешалка	40	20	$4 \times I_e$	0
Фрезерный станок	40	20	$4 \times I_e$	0

Быстрый запуск в эксплуатацию  
3RW40 SIRIUS  
Устройство плавного пуска

1. Проверка проводных соединений  
- управляющей части и  
- силовой части

2. Параметрирование устройства  
**Защита двигателя**  
- настроить на задатчике  $I_e$  номинальный ток привода  
- переключателем CLASS настроить требуемый класс отключения.  
**Функция плавного пуска**  
- параметр ограничения тока ( $x I_e$ )  
- время пуска (с)  
- начальное напряжение (%)  
- время выбега (с)  
настроить на желаемые значения (см. таблицу предложение по настройке)

3. Проверить напряжения в управляющем и силовом токовом контуре и включить.

По показаниям светодиодов и таблице состояний необходимо определить причину ошибки и устранить её. (см. Страница 25)

Светодиод "DEVICE" непрерывный зеленый свет, другие светодиоды выключены?

да  
нет

4. Включить устройство плавного пуска (IN 0 -> 1)

Светодиоды: "DEVICE" непрерывный зеленый свет, "STATE/BYPASSED" мигает зеленым светом?

да  
нет

Двигатель запускается плавно?

да  
нет

Быстро ли достигается в течение желаемого времени ном. частота вращ. двигателя?

да  
нет

Светодиоды: "DEVICE" непрерывный зеленый свет, "STATE/BYPASSED" непрерывный зеленый свет?

да  
нет

Выключить устройство плавного пуска (IN 1 -> 0).

Какой тип выбега выбран?

Свободный выбег  
Плавный выбег

Двигатель останавливается как запланировано?

да  
нет

Ввод в экспл-ию завершен



Русский



## Обзор индикации

		Светодиодная индикация 3RW40				Вспомогательные контакты			
		УПП		Защита двигателя					
3RW40		DEVICE (rd/gn/ylw)	STATE / BYPASSED / FAILURE (gn/rd)	(ПЕРЕГРУЗ KA)/ OVERLOAD (rd)	RESET MODE (ylw/gn)	13 14 (ON)	13 14 (RUN)	24 23 (BYPASSED)	96 95 98 FAILURE / OVERLOAD
U <sub>s</sub> = 0		●	●	●	●				
Рабочее состояние	IN								
Выкл	0		●	●	●				
Пуск	1			●	●				
Байпасный режим	1			●	●				
Выбег	0			●	●				
Предупреждение									
Настройка I <sub>e</sub> /Class недопустима					●				
Пуск заблокир., устройство слишком горячее			●	●	●				
Ошибка									
Недопустим. напряжение питания электроники		●		●	●				
Недопустимая настройка I <sub>e</sub> /Class и IN (0 -> 1)					●				
Отключение защиты двигателя Реле перегрузки / термистор			●		●				
Термисторная защита двигателя Обрыв кабеля / короткое замыкание			●		●				
Устройство - термическая перегрузка				●	●				
- отсутствие напряжения нагрузки - выпадение фазы, отсутствует нагрузка				●	●				
Неисправность устройства				●	●				
Тестовая функция									
1) TEST t > 5 с (нажать)			●		●				
RESET MODE (нажать для смены режима)									
Ручной сброс		●	●	●	●				
Автоматический сброс		●	●	●					
Дистанционный сброс см. рис. 6.2		●	●	●					
Показания светодиодов									
				gn =	ylw =	rd =	1) Тест отключения защиты двигателя		
выкл	вкл	мигающий	мерцающий	зеленый	желтый	красный			

### ⚠ ПРЕДУПРЕЖДЕНИЕ





#### Автоматический повторный запуск.

#### Опасность летального исхода, тяжелых травм или повреждения имущества.

Не используйте режим автоматического сброса в тех ситуациях, когда неожиданный пуск двигателя по истечении времени восстановления готовности представляет опасность для персонала и имущества. Отмена команды пуска (например, с помощью контроллера) должна происходить до подачи команды на сброс, т.к. при неснятой команде пуска после выполнения команды на сброс происходит автоматический повторный пуск. Это особенно важно при срабатывании автомата защиты двигателя. Из соображений безопасности рекомендуется соединить выход "общей ошибки" (клеммы 95 и 96) с системой управления.

安装、使用和维护本设备前必须先阅读并理解本说明。

	<b>⚠ 危险</b>	<b>小心</b>
	<p><b>危险电压</b> <b>致命或重伤危险。</b> 操作设备时必须确保切断电源。</p>	

	<b>⚠ 危险</b>
	<p><b>危险电压。</b> <b>致命或重伤危险。</b> 为了避免受到电击或烧伤，机器有电压时，不允许触摸电机控制设备的接线端。电机控制器在关机状态时，输出接线端处也有电压。</p>

**单个启动器的安装间距（多个启动器安装布局参见软启动器系统手册）**

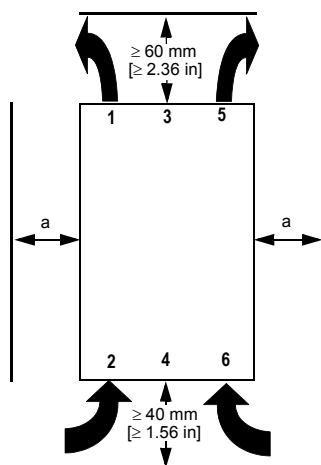

<b>注意</b>
<p>在安装此机器时，一定要注意规定的间距，以此保证足够的冷却空气流通。此机器是自下而上通风的。</p>

<b>小心</b>
<p><b>设备损坏危险。</b> 一定要注意不要有液体、灰尘或导电物体进入软启动器内部。</p>

a) 3RW40 2: 15 mm [0.59 in]  
3RW40 3; 3RW40 4: 30 mm [1.18 in]

**电机电流设定值**

当环境温度为摄氏 40° 时，依照 CLASS- 设置而确定的电机电流允许值

	$I_e$ [A]	$I_{min}$ [A]	$I_{max}$ [A] CLASS 10	$I_{max}$ [A] CLASS 15	$I_{max}$ [A] CLASS 20
3RW40 24-...	12,5	5	12,5	11	10
3RW40 26-...	25,3	10,3	25,3	23	21
3RW40 27-...	32,2	17,2	32,2	30	27
3RW40 28-...	38	23	38	34	31
3RW40 36-...	45	22,5	45	42	38
3RW40 37-...	63	25,5	63	50	46
3RW40 38-...	72	34,5	72	56	50
3RW40 46-...	80	42,5	80	70	64
3RW40 47-...	106	46	106	84	77

**ON/RUN 输出端连接 13/14 的编程（出厂设置：ON）（图表部分，图 3）**

- 启动编程：**（如图 2 所示取下设备 3RW40 2 的盖板。）按住按键 "RESET MODE" (2) 2 秒钟以上，直到 LED 显示灯 "DEVICE" (5) 发出快速颤动的绿光。按住按键 "RESET MODE"(2) 且同时按住按键 "RESET/TEST" (1) 1 秒钟以上，直到 设备上的 LED 显示灯 "DEVICE" (5) 发红光。
- 显示模式：** LED 显示灯 "STATE/BYPASSED/FAILURE" (6) 闪烁绿光：ON 模式。LED 显示灯 "STATE/BYPASSED/FAILURE"(6) 发出快速颤动的绿光：RUN 模式
- 切换模式：** 操作按键 "RESET MODE" (2)。
- 结束编程并保存设置：** 按住按键 "RESET/TEST" (1) 1 秒钟以上，直到 LED "DEVICE" (5) 发绿光 。

# 快捷式首次启动运行指南

## 热敏电阻连接（只用于 3RW40.-TB0.）

- 按照图表 6.3 连接 ThermoClick（去掉线桥）。
- 按照图表 6.4 连接 PTC 型号 A（去掉线桥）。

### 小心

**物品损坏危险。**  
不允许连接到未被占用的接线端上。

参考设置	启动参数		减速停止参数
应用领域	启动电压 %	启动时间 s	减速停止时间 s
传送带	70	10	5
滚子传送带	60	10	5
压缩机	50	10	0
小风扇	40	10	0
泵	40	10	10
液压泵	40	10	0
搅动装置	40	20	0
铣床	40	20	0

## 快捷式首次启动运行 3RW40 SIRIUS 软启动器

1. 布线检查  
- 控制部分与  
- 功能部分

2. 给设备设定参数  
**电机保护**  
- 在  $I_e$ - 设置器上设置驱动装置的电机额定电流  
- 在 CLASS- 开关上设定所需的断路级别。  
**软启动功能**  
- 电流界限值 ( $\times I_e$ )  
- 启动时间 (s)  
- 启动电压 (%)  
- 减速停止时间 (s)  
设定所需值（参见参考设置表）

3. 检查并接通控制电路与主电路的电压。

通过 LED- 显示器和状态表来查找故障原因并排除故障。（见 28 页）

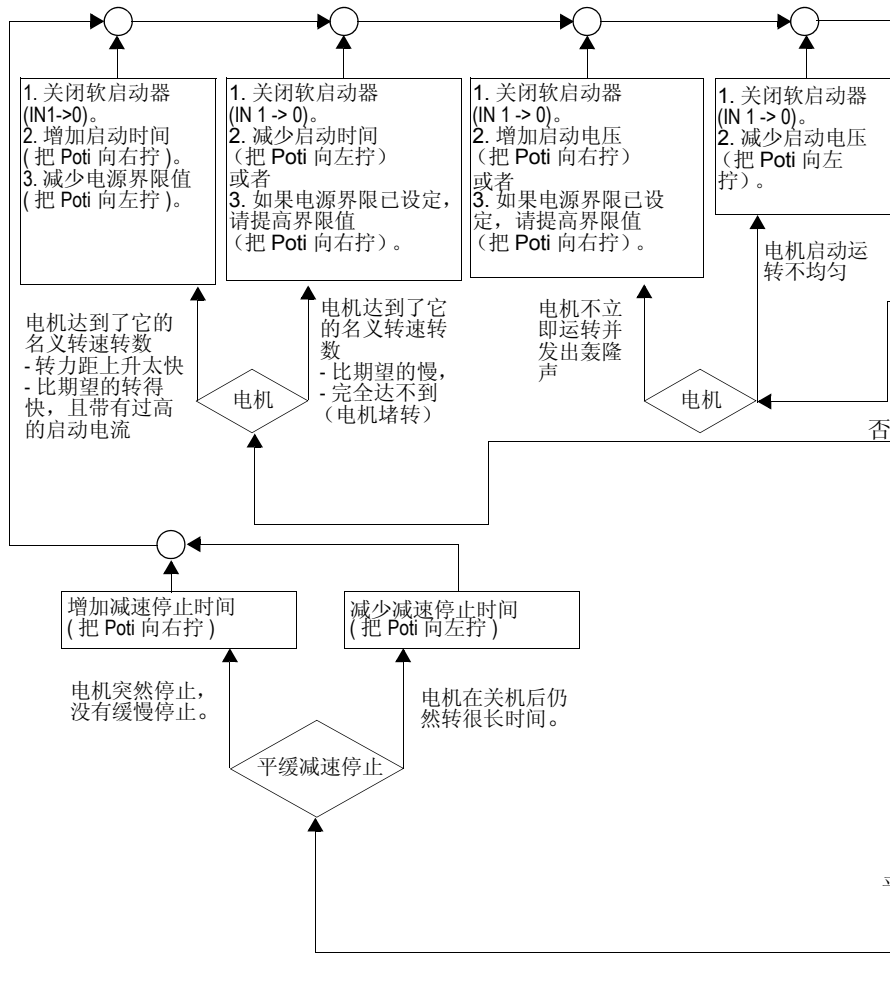
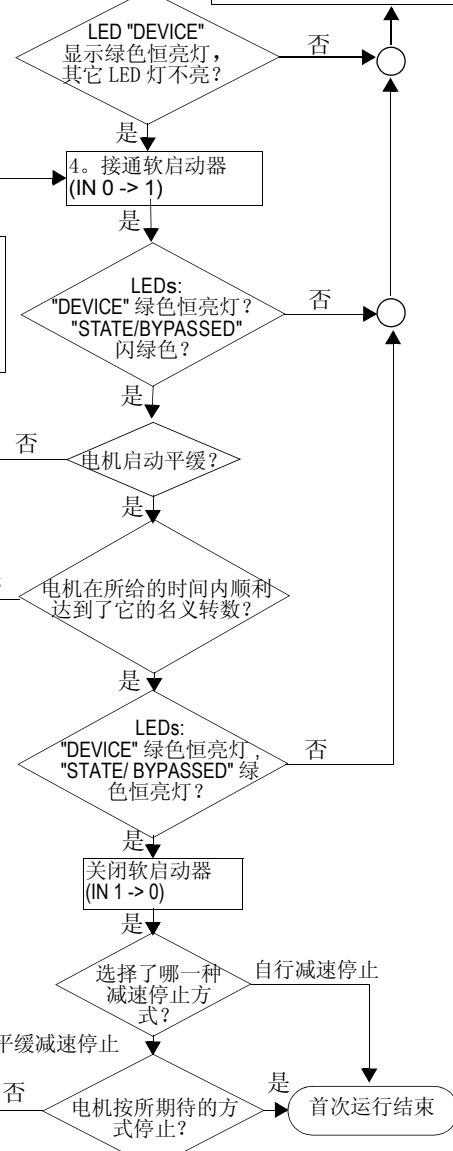

中文

# 显示器显示概览

		LED- 显示 3RW40				辅助触点			
		软启动器		电机保护					
3RW40		DEVICE (rd/gn/ylw)	STATE / BYPASSED / FAILURE (gn/rd)	OVERLOAD (rd)	RESET MODE (ylw/gn)	13 14 (ON)	13 14 (RUN)	24 23 (BYPASSED)	96 95 98 FAILURE / OVERLOAD
U <sub>s</sub> = 0		●	●	●	●				
运行状态	IN								
关	0	gn	●	●	●				
启动	1	gn	gn	●	●				
旁通	1	gn	gn	●	●				
减速停止	0	gn	gn	●	●				
警告									
不允许的 I <sub>e</sub> /Class- 设置		gn	gn  gn		●				
设备过热，禁止启动		ylw	●	●	●				
故障									
电子设备不允许的馈电电压		●	rd	●	●				
不允许的 I <sub>e</sub> /Class- 设置和 IN (0 -> 1)		gn	rd		●				
电机保护断路 过载继电器 / 热敏电阻		gn	●		●				
热敏电阻电机保护 电线破损 / 短路		gn	●		●				
设备过热		ylw	rd	●	●				
- 无负载电压 - 相位缺失，无负载		gn	rd	●	●				
设备故障		rd	rd	●	●				
测试键 TEST 的功能									
1) 按 TEST 键 5 秒以上		gn	●	rd	●				
RESET MODE 复位模式 (按此键切换)									
Manual Reset 手动复位		●	●	●	●				
Auto Reset 自动复位		●	●	●	ylw				
Remote Reset 远程复位 见图 6.2		●	●	●	gn				
LED 灯显示									
				gn =	ylw =	rd =	1) 测试电机保护断路		
不亮	亮	闪烁	快速颤动	绿	黄	红			

## 警告



### 自动重新启动

可能导致人员死亡、重伤或设备损坏。

如果电机在重启待机时间过后因无法预料的自行重新启动而有可能导致人员伤亡或物品损坏时，则不允许使用自动复位模式 (RESET MODE)。

必须在发出复位命令之前撤回启动命令 (如通过 SPS)，因为在有启动命令的情况下，设备会在复位命令后自行重新再启动。特别是在发生电机保护脱钩的情况时。出于安全考虑，建议把总故障输出端 (接线端 95 和 96) 连接到控制上去。

1.

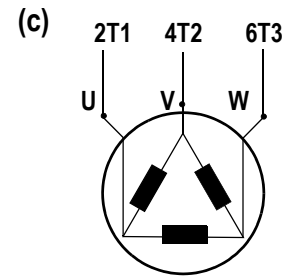
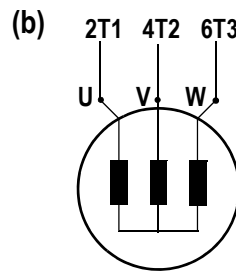
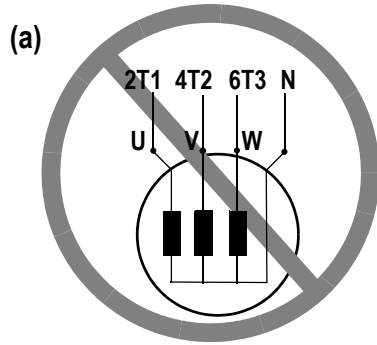

2.

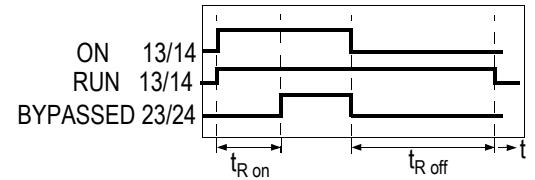
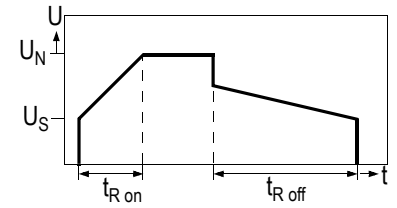
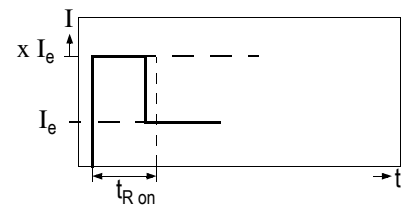
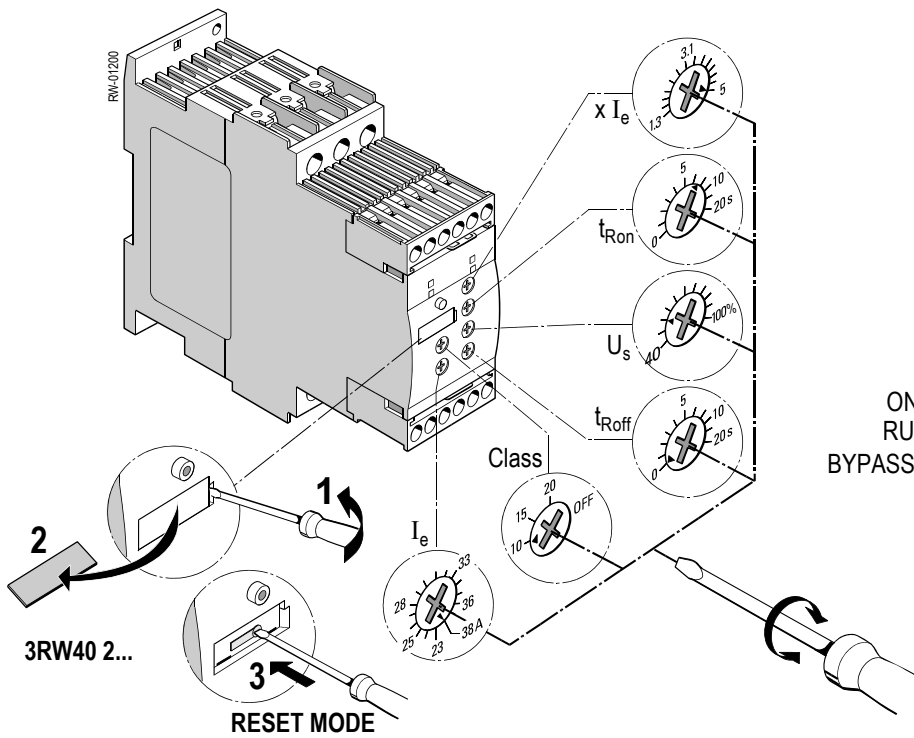

3.

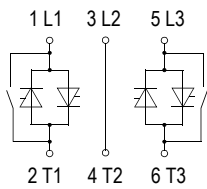

U<sub>s</sub>: 3RW40...-B0.: ≈ 24 V ± 20 %  
 3RW40...-B1.: ≈ 110...230 V -15 % / +10 %

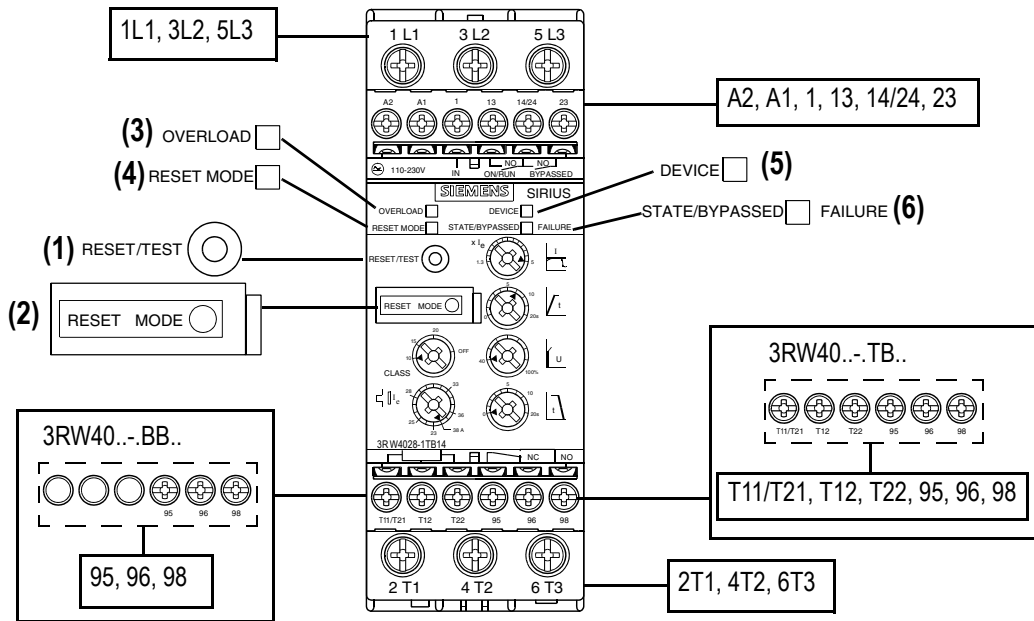

4.

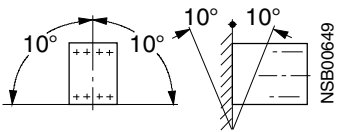

5.

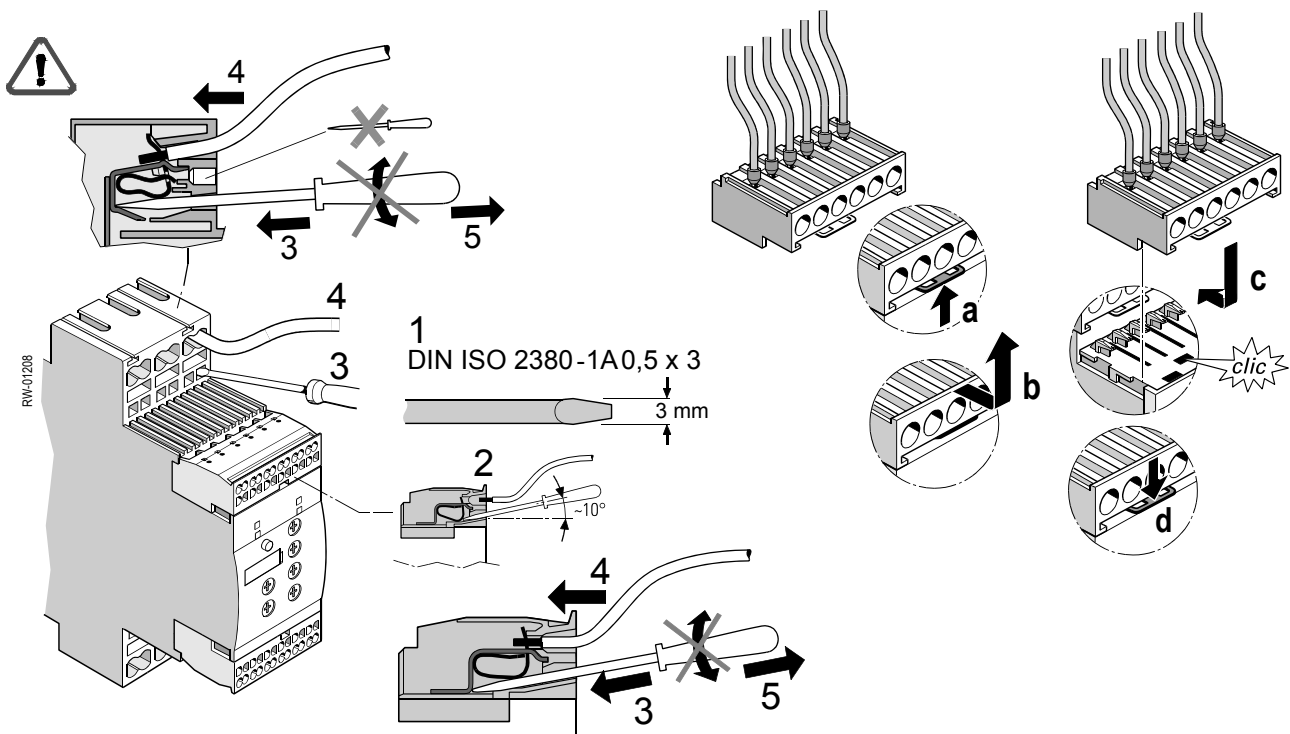

## 6.

### 6.1

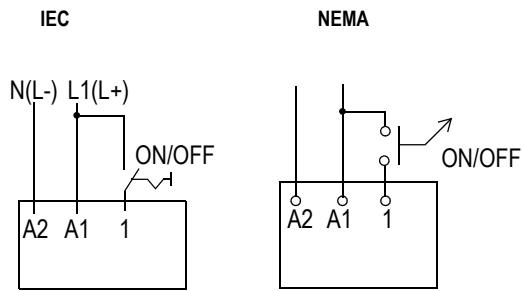

### 6.3

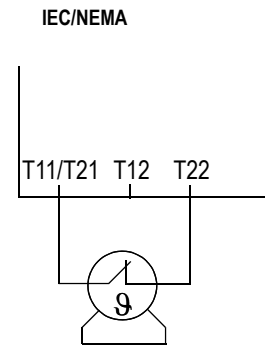

### 6.5

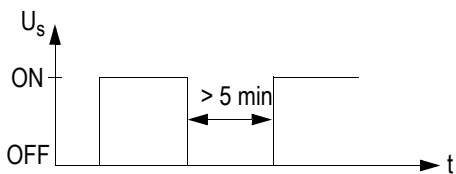
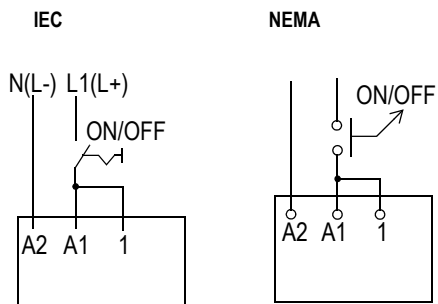

### 6.2

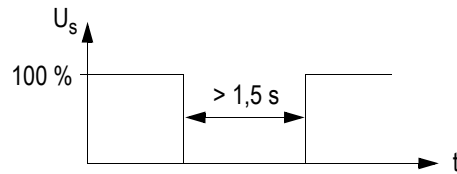
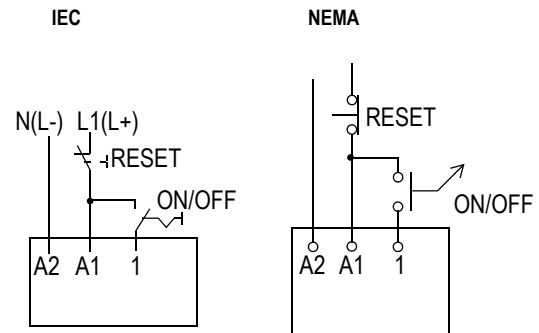

### 6.4

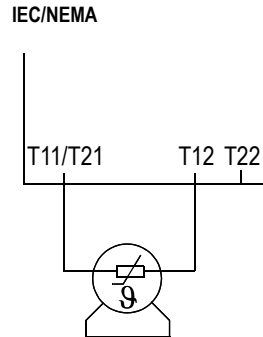

### 6.6

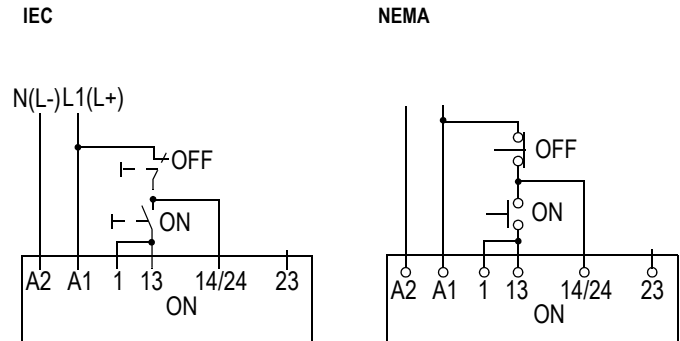

### 6.7 IEC

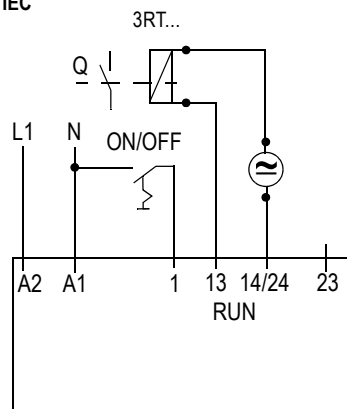

### NEMA

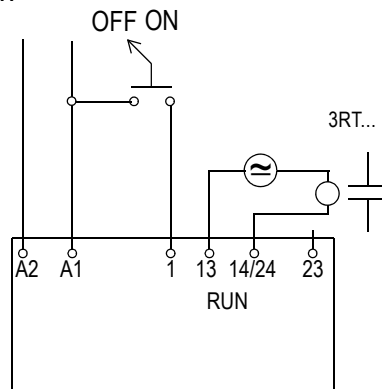

7.

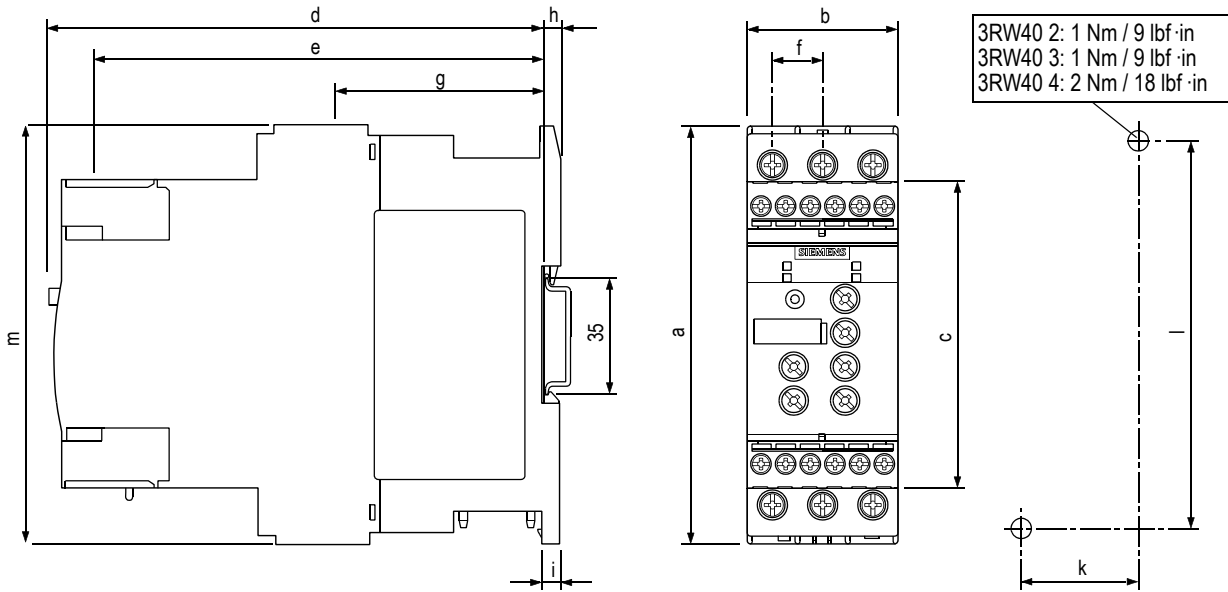

	a	b	c	d	e	f	g	h	i	k	l	m
<b>3RW40 2.-1....</b>	125 (4.92)	45 (1.8)	92 (3.62)	149 (5.90)	126 (5.00)	14,4 (0.57)	63 (2.48)	5 (0.2)	6,5 (0.26)	35 (1.38)	115 (4.53)	125 (4.92)
<b>3RW40 2.-2....</b>	125 (4.92)	45 (1.8)	92 (3.62)	149 (5.90)	144 (5.67)	14,4 (0.57)	90,5 (3.56)	5 (0.2)	6,5 (0.26)	35 (1.38)	115 (4.53)	150 (5.90)
<b>3RW40 3</b>	160 (6.3)	55 (2.18)	110 (4.33)	165 (6.49)	140 (5.51)	18 (0.71)	63 (2.48)	5 (0.2)	6,5 (0.26)	30 (1.18)	150 (5.91)	144 (5.67)
<b>3RW40 4</b>	170 (6.7)	70 (2.76)	110 (4.33)	183 (7.20)	158 (6.22)	22,5 (0.89)	85 (3.35)	5 (0.2)	10 (0.4)	60 (2.36)	160 (6.3)	160 (6.3)

mm (inch)