

SIRIUS

Sanftstarter 3RW30

Soft starter 3RW30

Démarreur progressif 3RW30

Arrancador suave 3RW30

Avviatore dolce 3RW30

Chave de partida suave 3RW30

Yumuşak yol verici 3RW30

Прибор для плавного запуска 3RW30

软启动器 3RW30

3RW301

3RW302

3RW303

3RW304



EN/IEC 60947-4-2

DE	Sanftstarter 3RW30 Betriebsanleitung — Bestell-Nr.: 3ZX1012-0RW30-2DA1 Grafiken	Seite 2 - 3 20 - 22
EN	Soft starter 3RW30 Operating Instructions — Order No.: 3ZX1012-0RW30-2DA1 Graphics	Page 4 - 5 20 - 22
FR	Démarreur progressif 3RW30 Instructions de service — N° de référence : 3ZX1012-0RW30-2DA1 Graphiques	Page 6 - 7 20 - 22
ES	Arrancador suave 3RW30 Instructivo — Referencia: 3ZX1012-0RW30-2DA1 Gráficos	Página 8 - 9 20 - 22
IT	Avviatore dolce 3RW30 Istruzioni operative — N° di ordinaz.: 3ZX1012-0RW30-2DA1 Grafiche	Pagina 10 - 11 20 - 22
PT	Chave de partida suave 3RW30 Instruções de Serviço — N° de enc.: 3ZX1012-0RW30-2DA1 Gráficos	Página 12 - 13 20 - 22
TR	Yumuşak yol verici 3RW30 İşletme kılavuzu — Sipariş no.: 3ZX1012-0RW30-2DA1 grafikler	Sayfa 14 - 15 20 - 22
PY	Прибор для плавного запуска 3RW30 Инструкция по эксплуатации — № для заказа: 3ZX1012-0RW30-2DA1 графики	Страница 16 - 17 20 - 22
中文	软启动器 3RW30 操作规程 - 订货号: 3ZX1012-0RW30-2DA1 图表	第 18 - 19 和 20 - 22 页

Technical Assistance: Telephone: +49 (0) 911-895-5900 (8°° - 17°° CET)
Fax: +49 (0) 911-895-5907
E-mail: technical-assistance@siemens.com
Internet: www.siemens.com/industrial-controls/technical-assistance

SIEMENS AG
Technical Assistance
Würzburger Str. 121
D-90766 Fürth

Vor der Installation, dem Betrieb oder der Wartung des Geräts muss diese Anleitung gelesen und verstanden werden.

⚠ GEFAHR

Gefährliche Spannung. Lebensgefahr oder schwere Verletzungsgefahr.
Vor Beginn der Arbeiten Anlage und Gerät spannungsfrei schalten.

VORSICHT

Eine sichere Gerätefunktion ist nur mit zertifizierten Komponenten gewährleistet!

⚠ GEFAHR

Gefährliche Spannung. Lebensgefahr oder schwere Verletzungsgefahr.
Um elektrischen Stromschlag oder Verbrennungen zu vermeiden, dürfen die Klemmen des Motorsteuergeräts nicht berührt werden, wenn das Gerät mit Spannung versorgt wird. An den Ausgangsklemmen steht auch im AUS-Zustand des Motorsteuergeräts Spannung an.

Einbauabstände in Einzelaufstellung (Dicht-an-dicht-Aufstellung siehe Sanftstarter-Handbuch)

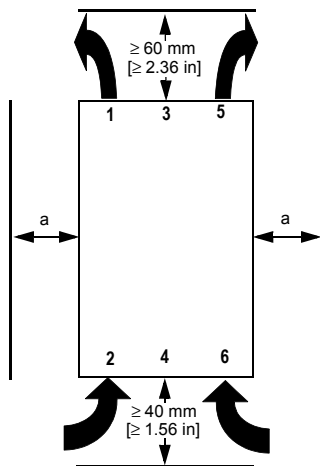

ACHTUNG

Beachten Sie beim Einbau des Geräts die angegebenen Abstände, damit genügend Luft für Kühlung zirkulieren kann. Das Gerät wird von unten nach oben belüftet.

VORSICHT

Gefahr von Sachschäden.
Achten Sie darauf, dass keine Flüssigkeit, kein Staub oder leitender Gegenstand in den Sanftstarter gelangt.

- a) 3RW301; 3RW302: 15 mm [0.59 in]
3RW303; 3RW304: 30 mm [1.18 in]

Anzeigenübersicht

		LED-Anzeigen 3RW30		Hilfskontakt
		Sanftstarter		
3RW30		DEVICE (rd / gn / ylw)	STATE / BYPASSED / FAILURE (gn / rd)	13 14 (ON)
$U_s = 0$		●	●	— / —
Betriebszustand	IN			
Aus	0	☀ gn	●	— / —
Anlauf	1	☀ gn	◐ gn	— / —
Bypassed	1	☀ gn	☀ gn	— / —
Fehler				
Versorgungsspannung Elektronik unzulässig		●	☀ rd	— / —
Bypass-Überlastung		☀ ylw	☀ rd	— / —
- fehlende Lastspannung - Phasenausfall, fehlende Last		☀ gn	☀ rd	— / —
Gerätefehler		☀ rd	☀ rd	— / —

Anzeige der LEDs					
●	☀	◐	gn	rd	ylw
			=	=	=
aus	ein	blinkend	grün	rot	gelb

HINWEIS

Dies ist ein Produkt für Umgebung A. In Haushaltsumgebung kann dieses Gerät unerwünschte Funkstörungen verursachen. In diesem Fall kann der Anwender verpflichtet sein, angemessene Maßnahmen durchzuführen.

Schnellinbetriebnahmeanleitung

VORSICHT

Gefahr von Sachschäden.

Anschluss an nicht belegte Klemmen ist unzulässig.

Anwendung	Anlauf Parameter	
	Startspannung %	Anlaufzeit s
Förderband	70	10
Rollenförderer	60	10
Kompressor	50	20
kleiner Ventilator	40	20
Pumpe	40	10
Hydraulikpumpe	40	10
Rührwerk	40	20

VORSICHT



Gefahr von Sachschäden.

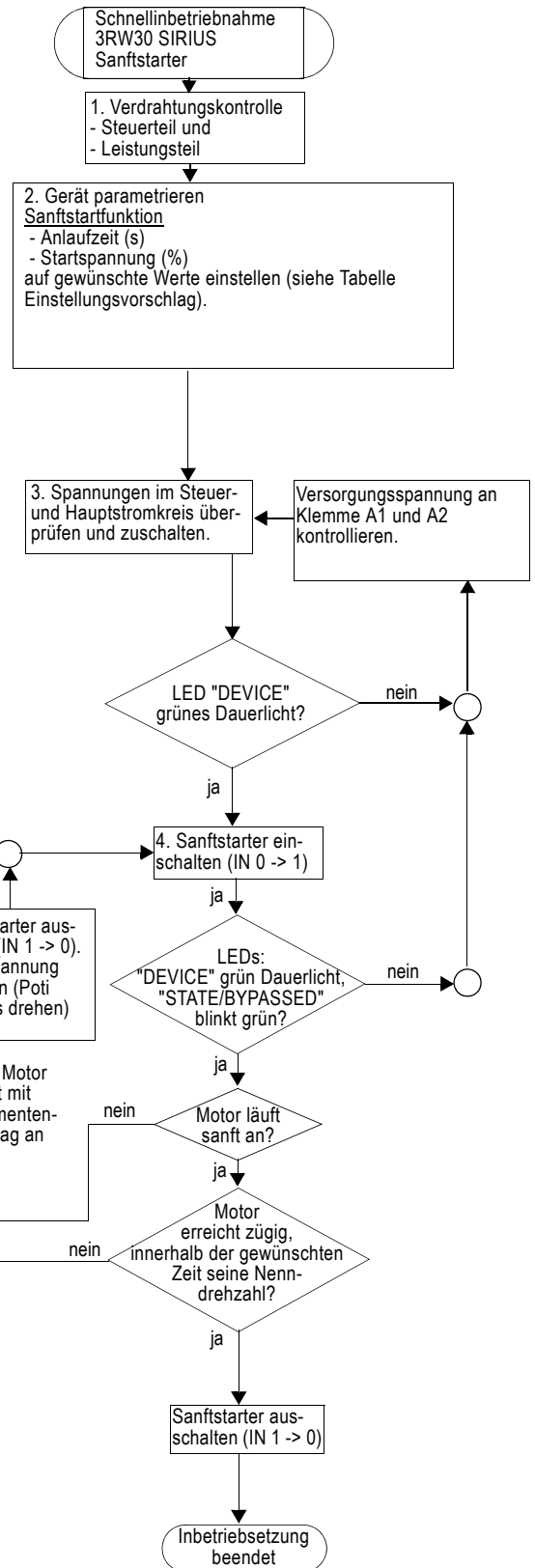

Beachten Sie die Schalthäufigkeit (siehe techn. Daten Katalog). Eine zu hohe Schalthäufigkeit kann den Sanftstarter beschädigen.



Read and understand these instructions before installing, operating, or maintaining the equipment.

English

 	⚠ DANGER	Hazardous voltage. Will cause death or serious injury. Turn off and lock out all power supplying this device before working on this device.	CAUTION
	Reliable functioning of the equipment is only ensured with certified components.		

 	⚠ DANGER	Hazardous voltage. Will cause death or serious injury. To avoid electrical shock or burn, do not touch soft starter terminals when voltage is applied to the soft starter. Output terminals will have voltage present even when soft starter is OFF.
--	-----------------	--

Stand-alone installation spacings (see soft starter manual for side-by-side installation)

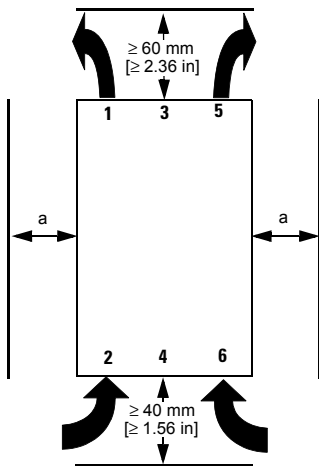

NOTICE

Leave sufficient free space to ensure that the air required for cooling purposes can circulate from the bottom to the top of the unit.

CAUTION

Risk of damage to property.
 Ensure that no liquids, dust or conductive parts enter the soft starter.

NOTE

Surrounding air temperature - A rating assigned to open type equipment that refers to the maximum ambient temperature of air immediately surrounding the equipment inside of the ultimate enclosure.

- a) 3RW301; 3RW302: 15 mm [0.59 in]
- 3RW303; 3RW304: 30 mm [1.18 in]

Display overview

		LED displays on 3RW30		Auxiliary contact
		Soft starter		
3RW30		DEVICE (rd / gn / ylw)	STATE / BYPASSED / FAILURE (gn / rd)	13 14 (ON)
$U_s = 0$		●	●	— / —
Operating state	IN			
OFF	0	☀ gn	●	— / —
Start-up	1	☀ gn	◐ gn	— / —
Bypassed	1	☀ gn	☀ gn	— / —
Error				
Supply voltage electronics invalid		●	☀ rd	— / —
Bypass overload		☀ ylw	☀ rd	— / —
- Missing supply voltage - Phase failure, no load		☀ gn	☀ rd	— / —
Device fault		☀ rd	☀ rd	— / —

LED display			gn	rd	ylw
●	☀	◐	=	=	=
OFF	ON	flashing	green	red	yellow

NOTE

This is a product for environment A. When used in a household setting, this device can cause unwanted radio interference. In this case the user may be required to carry out appropriate measures to avoid such radio interference.

Quick commissioning instructions

CAUTION

Risk of damage to property.
Connection to an unassigned terminal is not permitted.

Suggested setting	Startup parameters	
Application	Start voltage %	Starting time s
Conveyor belt	70	10
Roller conveyor	60	10
Compressor	50	20
Small fan	40	20
Pumps	40	10
Hydraulic pump	40	10
Stirrers	40	20

CAUTION

Risk of damage to property.
Please take the switching frequency into consideration (see techn. data catalog).
If the switching frequency is too high, it could damage the soft starter.

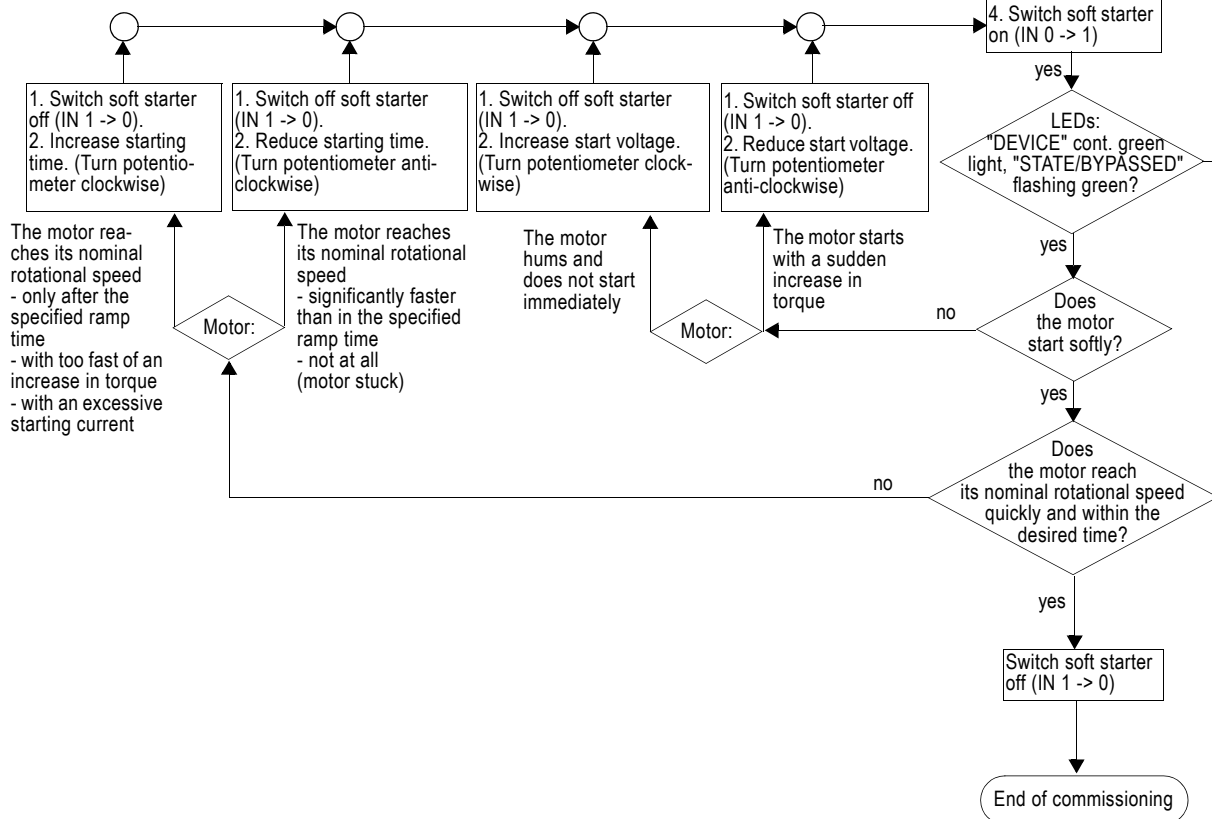

Ne pas installer, utiliser ou intervenir sur cet équipement avant d'avoir lu et assimilé les présentes instructions et notamment les conseils de sécurité et mises en garde qui y figurent.

⚠ DANGER

**Tension dangereuse.
Danger de mort ou risque de blessures graves.
Mettre hors tension avant d'intervenir sur l'appareil.**

PRUDENCE

Le fonctionnement sûr de l'appareil n'est garanti qu'avec des composants certifiés.

⚠ DANGER

**Tension dangereuse.
Danger de mort ou risque de blessures graves.**
Pour éviter tout risque d'électrocution ou de brûlures, ne pas toucher les bornes du démarreur lorsque celui-ci est sous tension. Les bornes de sortie sont sous tension même lorsque le démarreur est hors tension.

PRUDENCE

Le fonctionnement sûr de l'appareil n'est garanti qu'avec des composants certifiés.

**Distances de montage pour installation séparée
(installation juxtaposée, voir le manuel système Démarreurs progressifs)**

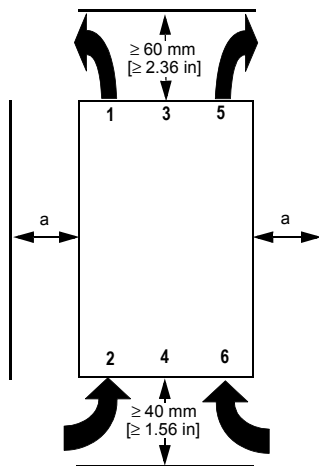

IMPORTANT

Respecter un espace libre suffisant pour assurer la circulation de l'air nécessaire au refroidissement, qui se fait par ventilation du bas vers le haut.

PRUDENCE

Risque de dommages matériels.
Veillez à ce que ni liquide, ni poussière ou objet conducteur ne puisse pénétrer dans le démarreur progressif.

a) 3RW301; 3RW302: 15 mm [0.59 in]
3RW303; 3RW304: 30 mm [1.18 in]

Vue d'ensemble des affichages

		LED de signalisation 3RW30		Contact auxiliaire
		Démarrateur progressif		
3RW30		DEVICE (rd / gn / ylw)	STATE / BYPASSED / FAILURE (gn / rd)	13 14 (ON)
$U_s = 0$		●	●	— / —
Etat de fonctionnement	IN			
Arrêté	0	☀ gn	●	— / —
Démarrage	1	☀ gn	◐ gn	— / —
Bypassed	1	☀ gn	☀ gn	— / —
Défauts				
Tension d'alimentation de l'électronique incorrecte		●	☀ rd	— / —
Surcharge bypass		☀ ylw	☀ rd	— / —
- tension de charge manque - coupure de phase, charge non raccordée		☀ gn	☀ rd	— / —
Défaut sur l'appareil		☀ rd	☀ rd	— / —

Affichage des LED					
●	☀	◐	gn	rd	ylw
			=	=	=
éteinte	allumée	clignotante	verte	rouge	jaune

NOTE

Ceci est un produit pour environnement A. Utilisé dans un cadre domestique, cet appareil peut causer des interférences radio indésirables. Dans ce cas, l'utilisateur peut être obligé de prendre les mesures nécessaires pour éviter de telles interférences.

Instructions de mise en service rapide

PRUDENCE

Risque de dommages matériels.

Un raccordement aux bornes libres est inadmissible.

Proposition de réglage	Paramètres de démarrage	
	Tension démarrage %	Temps démarrage s
Application		
Convoyeur	70	10
Convoyeur à rouleaux	60	10
Compresseur	50	20
Petit ventilateur	40	20
Pompe	40	10
Pompe hydraulique	40	10
Malaxeur	40	20

PRUDENCE

Risque de dommages matériels.

Veillez respecter la fréquence de manœuvres (voir les caractéristiques techniques dans le catalogue). Une fréquence de manœuvres trop élevée risque d'endommager le démarreur progressif.

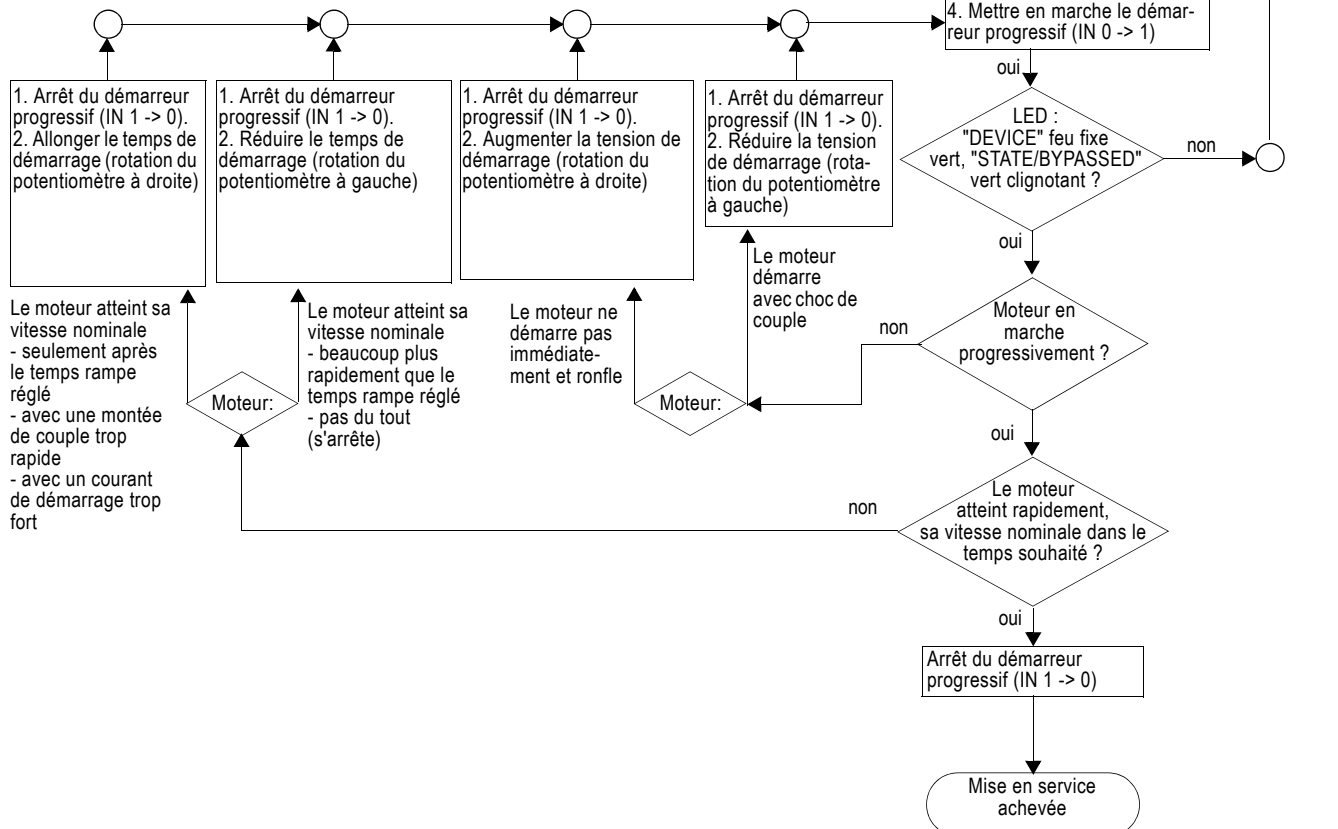

Leer y comprender este instructivo antes de la instalación, operación o mantenimiento del equipo.

⚠ PELIGRO

Tensión peligrosa. Puede causar la muerte o lesiones graves.
Desconectar la alimentación eléctrica antes de trabajar en el equipo.

PRECAUCIÓN

El funcionamiento seguro del aparato sólo está garantizado con componentes certificados.

⚠ PELIGRO

Tensión peligrosa. Puede causar la muerte o lesiones graves.
Para evitar todo riesgo de electrocución o de quemaduras, no tocar los bornes del arrancador mientras estén bajo tensión. Los bornes de salida están bajo tensión aunque el arrancador esté desconectado (OFF).

Distancias de montaje para instalación simple (para instalación junto a otros aparatos, ver manual Arrancadores suaves)

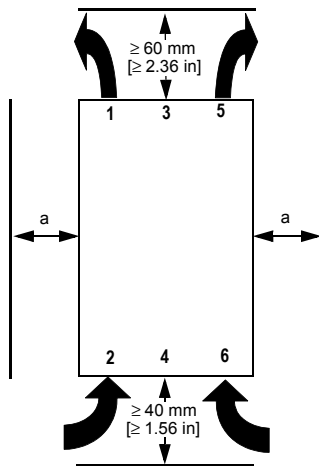

ATENCIÓN

Deje espacio libre suficiente para garantizar la circulación del aire necesario para el enfriamiento, que se realiza por ventilación de abajo hacia arriba.

PRECAUCIÓN

Peligro de daños materiales.
Preste atención de que no pueda ingresar líquido, polvo o algún objeto conductor al interno del arrancador suave.

- a) 3RW301; 3RW302: 15 mm [0.59 in]
3RW303; 3RW304: 30 mm [1.18 in]

Resumen de las indicaciones

	Indicadores LED 3RW30		Contacto auxiliar
	Arrancador suave		
3RW30	DEVICE (rd / gn / ylw)	STATE / BYPASSED / FAILURE (gn / rd)	13 14 (ON)
$U_s = 0$	●	●	
Estado operativo	IN		
Desconectado	0	☀ gn	
Arranque	1	☀ gn	
Bypassed	1	☀ gn	
Fallo			
Tensión de alimentación de la electrónica inadmisibles	●	☀ rd	
Sobrecarga de bypass	☀ ylw	☀ rd	
- Falta de tensión de red - Corte de fase, falta de carga	☀ gn	☀ rd	
Fallo del equipo	☀ rd	☀ rd	

Indicación de los LEDs					
●	☀	◐	gn	rd	ylw
			=	=	=
Apagado	Encendido	Intermitente	verde	rojo	amarillo

NOTA

Este es un producto para ambientes clase A. Usado en un entorno doméstico puede causar perturbaciones radioeléctricas indeseadas. En este caso, el usuario podrá verse obligado a tomar las medidas necesarias para evitar dichas perturbaciones.

Instrucciones para la puesta en servicio rápida

PRECAUCIÓN

Peligro de daños materiales.

No está admitida la conexión con bornes no ocupados.

Propuesta de ajuste	Parámetros de arranque	
Aplicación	Tensión inicial %	Tiempo de arranque s
Cinta transportadora	70	10
Transportador a rodillos	60	10
Compresor	50	20
Ventilador pequeño	40	20
Bomba	40	10
Bomba hidráulica	40	10
Mezcladora	40	20

PRECAUCIÓN

Peligro de daños materiales.

Tenga en cuenta la frecuencia de maniobras (ver catálogo Datos técnicos).

Una frecuencia de maniobras demasiado elevada puede dañar el arrancador suave.

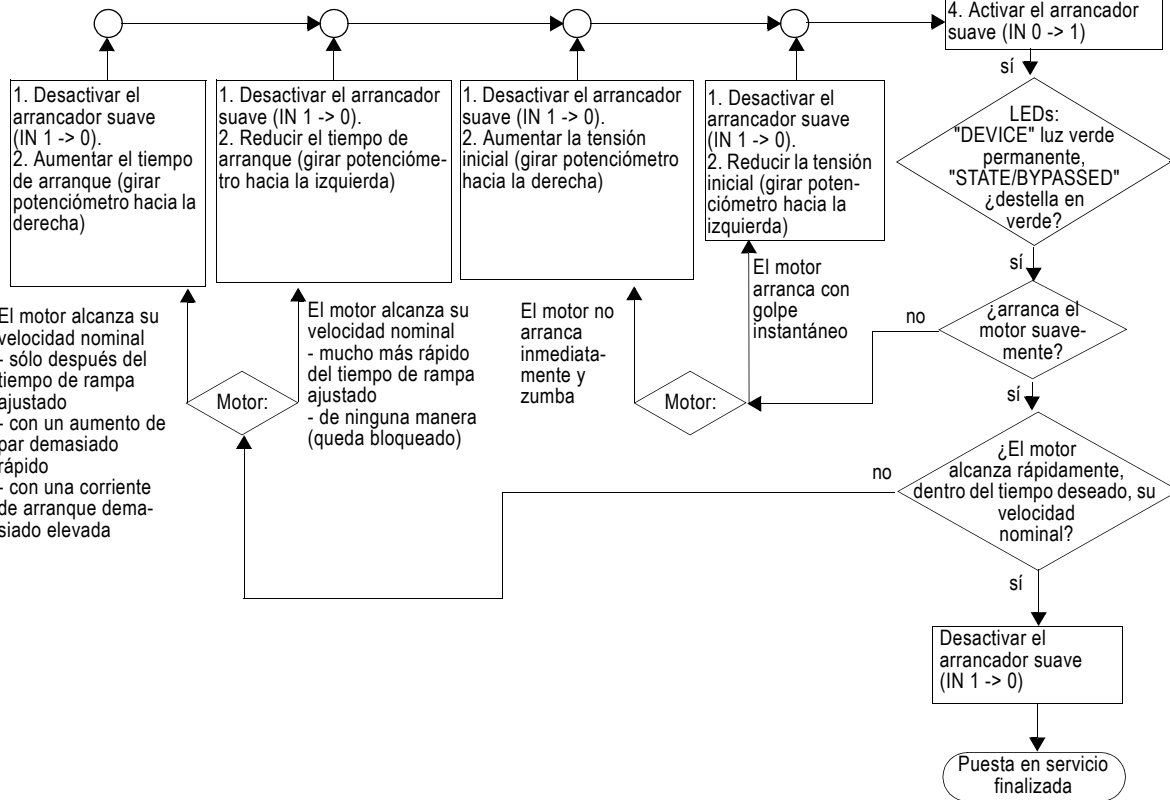

Leggere con attenzione queste istruzioni prima di installare, utilizzare o eseguire manutenzione su questa apparecchiatura.

⚠ PERICOLO

Tensione pericolosa. Può provocare morte o lesioni gravi.
Scollegare l'alimentazione prima di eseguire interventi sull'apparecchiatura.

CAUTELA

Il funzionamento sicuro dell'apparecchiatura è garantito soltanto con componenti certificati.

⚠ PERICOLO

Tensione pericolosa. Può provocare morte o lesioni gravi.
Per evitare pericoli di folgorazione o di ustione, non toccare i morsetti dell'avviatore quando l'apparecchiatura è sotto tensione. I morsetti d'uscita sono sotto tensione anche quando l'avviatore è disinserito.

CAUTELA

Il funzionamento sicuro dell'apparecchiatura è garantito soltanto con componenti certificati.

Distanze di montaggio nell'installazione singola (per l'installazione compatta vedi manuale Avviatore dolce)

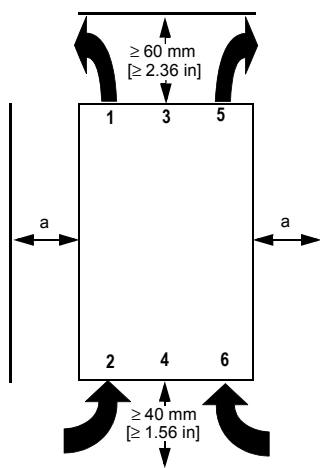

ATTENZIONE

Lasciare abbastanza spazio libero, per consentire una circolazione sufficiente di aria di raffreddamento. L'apparecchio viene ventilato dal basso verso l'alto.

CAUTELA

Pericolo di danni alle cose.
Evitare che liquidi, polvere o altri conduttori finiscano nell'avviatore dolce.

- a) 3RW301; 3RW302: 15 mm [0.59 in]
3RW303; 3RW304: 30 mm [1.18 in]

Elenco delle indicazioni

		LED di segnalazione 3RW30		Contatto ausiliare
		Avviatore dolce		
3RW30		DEVICE (rd / gn / ylw)	STATE / BYPASSED / FAILURE (gn / rd)	13 14 (ON)
U _s = 0		●	●	
Stato operativo	IN			
OFF	0	☀ gn	●	
Avviamento	1	☀ gn	◐ gn	
Bypassed	1	☀ gn	☀ gn	
Errore				
Tensione di alimentazione dell'elettronica non ammessa		●	☀ rd	
Sovraccarico di bypass		☀ ylw	☀ rd	
- Tensione di carico mancante - Caduta di fase, carico mancante		☀ gn	☀ rd	
Guasto dell'apparecchio		☀ rd	☀ rd	

Indicazione dei LED					
●	☀	◐	gn	rd	ylw
			=	=	=
OFF	ON	lampeggiante	verde	rosso	giallo

NOTA

Questo è un prodotto per ambiente A. In ambito domestico, questo dispositivo può provocare radiointerferenze indesiderate. In tal caso è possibile che l'utente sia tenuto ad adottare misure adeguate al fine di evitare tali interferenze.

Istruzioni per messa in servizio rapida

CAUTELA

Pericolo di danni alle cose.

Non è ammesso il collegamento a morsetti non assegnati.

Consiglio di installazione	Avviamento parametri	
Applicazione	Tensione di avviamento %	Tempo di avviamento s
Nastro trasportatore	70	10
Trasportatore a rulli	60	10
Compressore	50	20
Piccolo ventilatore	40	20
Pompa	40	10
Pompa idraulica	40	10
Mescolatore	40	20

CAUTELA

Pericolo di danni alle cose.

Fare attenzione alla frequenza di commutazione (vedere Catalogo Dati Tecnici).

Una frequenza di commutazione eccessiva può danneggiare l'avviatore dolce.

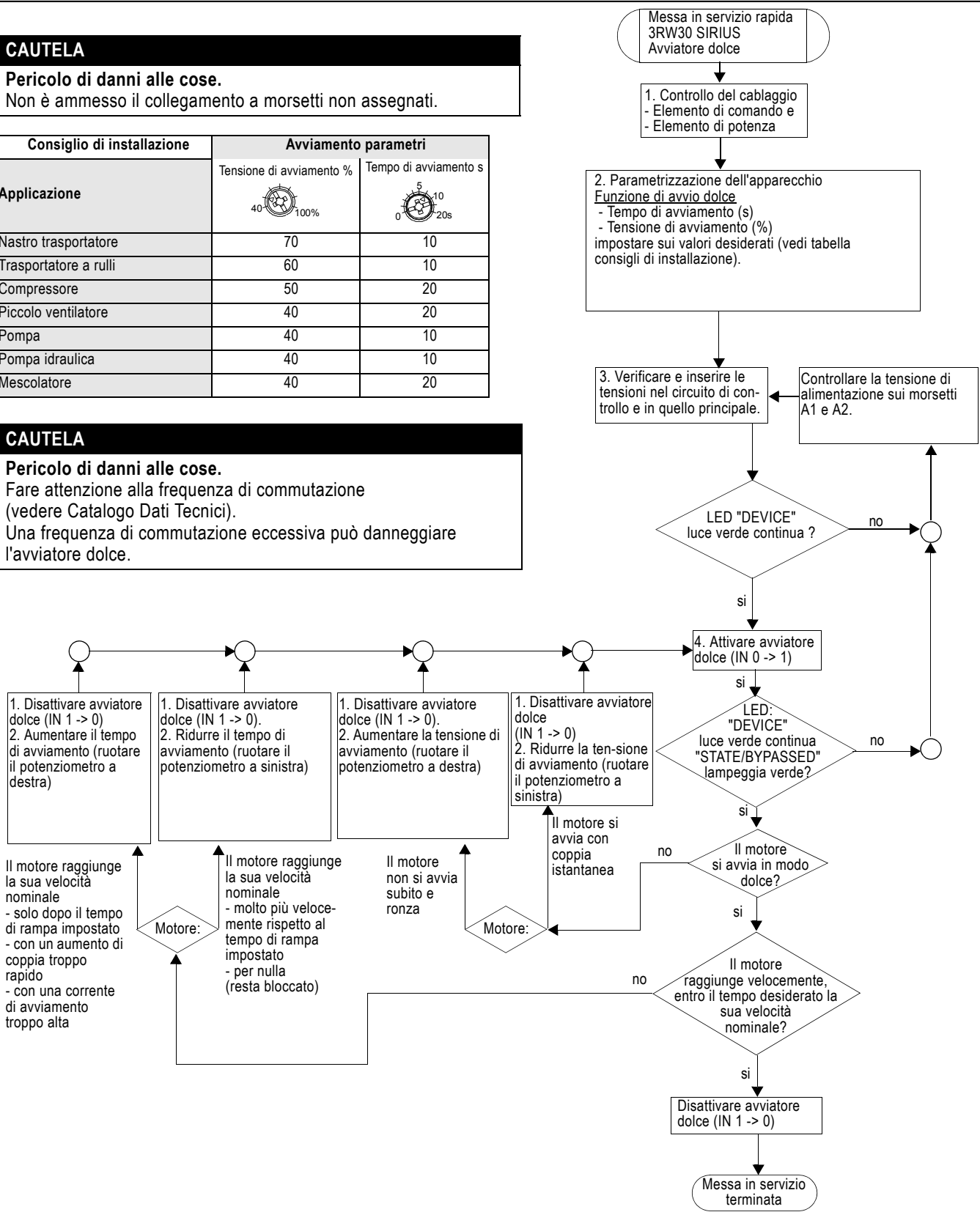

Italiano

Ler e compreender estas instruções antes da instalação, operação ou manutenção do equipamento.

	⚠ PERIGO	CUIDADO
	<p>Tensão perigosa. Perigo de morte ou ferimentos graves. Desligue a corrente antes de trabalhar no equipamento.</p>	<p>O funcionamento seguro do aparelho apenas pode ser garantido se forem utilizados componentes certificados.</p>

	⚠ PERIGO
	<p>Tensão perigosa. Perigo de morte ou de ferimentos graves. Para evitar qualquer risco de eletrocussão ou de queimaduras, não tocar nos bornes do softstarter enquanto este estiver sob tensão. Os bornes de saída estão sob tensão mesmo quando o softstarter está desligado (OFF).</p>

Distâncias na montagem individual (montagem junto a outros aparelhos, veja o manual do Chave de partida suave)

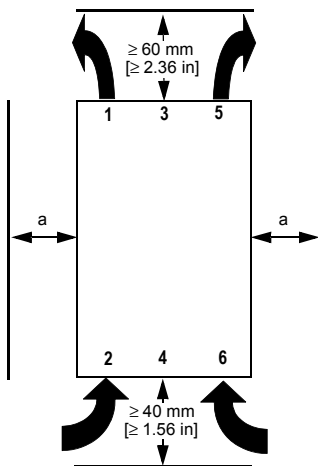

ATENÇÃO
<p>Deixe bastante espaço livre, para que possa circular ar suficiente para a refrigeração. O equipamento é ventilado de baixo para cima.</p>

CUIDADO
<p>Risco de danos materiais. Preste atenção de que não entre nenhum líquido, nenhuma poeira ou objeto condutivo dentro da chave de partida suave.</p>

- a) 3RW301; 3RW302: 15 mm [0.59 in]
3RW303; 3RW304: 30 mm [1.18 in]

Sinóptico de indicações

		Indicadores LED 3RW30		Contato auxiliar
		Chave de partida suave		
3RW30		DEVICE (rd / gn / ylw)	STATE / BYPASSED / FAILURE (gn / rd)	13 14 (ON)
$U_s = 0$		●	●	— / —
Estado operativo	IN			
Desligado	0	☀ gn	●	— / —
Partida	1	☀ gn	◐ gn	— / —
Bypassed	1	☀ gn	☀ gn	— / —
Erro				
Tensão de alimentação do sistema eletrônico não permissível		●	☀ rd	— / —
Sobrecarga do bypass		☀ ylw	☀ rd	— / —
- falta de tensão de carga - falha de fase, falta de carga		☀ gn	☀ rd	— / —
Erro de equipamento		☀ rd	☀ rd	— / —

Indicação dos LEDs					
●	☀	◐	gn	rd	ylw
=	=	=	=	=	=
Desligado	Ligado	Piscante	verde	vermelho	amarelo

OBSERVAÇÃO

Este é um produto para ambiente A. Em ambiente doméstico este equipamento pode causar radiointerferências indesejadas. Neste caso, o usuário pode ser obrigado a tomar as medidas cabíveis.

Instrução para a colocação em serviço rápida

CUIDADO

Risco de danos materiais.

Não é permitida a conexão a bornes não ocupados.

Proposta de ajuste	Parâmetros de partida	
	Tensão inicial %	Tempo de partida s
Aplicação		
Correia transportadora	70	10
Transportador de rolos	60	10
Compressor	50	20
Ventilador pequeno	40	20
Bomba	40	10
Bomba hidráulica	40	10
Agitador	40	20

CUIDADO



Risco de danos materiais.

Observe a frequência de operações (ver Catálogo de Dados técnicos).

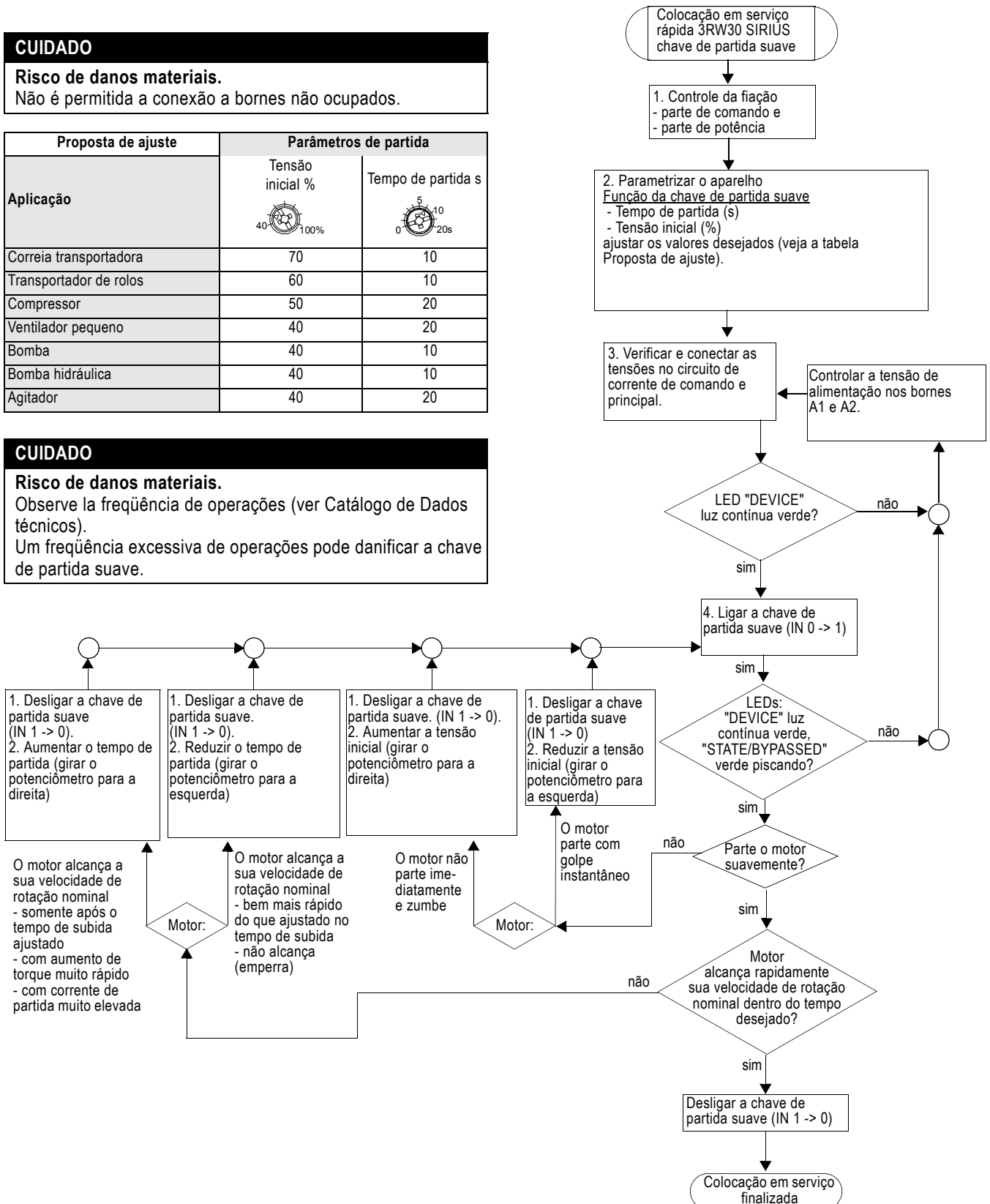
Um frequência excessiva de operações pode danificar a chave de partida suave.



Cihazın kurulumundan, çalıştırılmasından veya bakıma tabi tutulmasından önce, bu kılavuz okunmuş ve anlaşılmış olmalıdır.

 	⚠ TEHLİKE Tehlikeli gerilim. Ölüm tehlikesi veya ağır yaralanma tehlikesi. Çalışmalara başlamadan önce, sistemin ve cihazın gerilim beslemesini kapatınız.	ÖNEMLİ DİKKAT Cihazın güvenli çalışması ancak sertifikalı bileşenler kullanılması halinde garanti edilebilir.
	⚠ TEHLİKE Tehlikeli gerilim. Hayati tehlike veya ağır yaralanma tehlikesi. Cihaz gerilim beslemesi altında iken, elektrik çarpmasından veya yangınlardan sakınmak için, motor kontrol cihazının kışkırlarıyla temas edilmemelidir. Motor kontrol cihazı KAPALI halde iken de çıkış kışkırlarında gerilim mevcuttur.	

Tek tek kurulumda montaj mesafeleri (Sıkı kurulum bkz. Yumuşak yol verici kullanım kılavuzu)

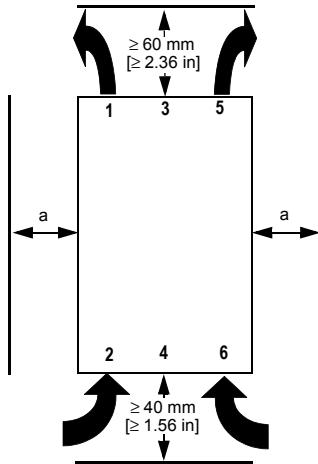

DİKKAT

Soğutma için yeterli derecede hava sirkülasyonunun sağlanması amacıyla cihazı monte ederken belirtilen mesafelere riayet ediniz. Cihaz, aşağıdan yukarıya doğru havalandırılmaktadır.









ÖNEMLİ DİKKAT

Maddi hasar tehlikesi.

Yumuşak yol vericiye sıvı, toz veya herhangi bir cisim kaçmamasına dikkat ediniz.

- a) 3RW301; 3RW302: 15 mm [0.59 in]
 3RW303; 3RW304: 30 mm [1.18 in]

Gösterge tablosu

		LED göstergeleri 3RW30		Yardımcı kontak
		Yumuşak yol verici		
3RW30		DEVICE (rd / gn / ylw)	STATE / BYPASSED / FAILURE (gn / rd)	13 14 (ON)
$U_s = 0$		●	●	
İşletme durumu	İN			
Kapalı	0	☀ gn	●	
Yol verme	1	☀ gn	◐ gn	
Bypassed	1	☀ gn	☀ gn	
Arıza				
Tedarik gerilimi Elektronik kabul edilmiyor		●	☀ rd	
Bypass aşırı yüklenme		☀ ylw	☀ rd	
- Yük gerilimi yok - Faz kesilmesi, eksik yük		☀ gn	☀ rd	
Cihaz hatası		☀ rd	☀ rd	

LED göstergeleri					
●	☀	◐	gn	rd	ylw
			=	=	=
kapalı	açık	yanıp söner	yeşil	kırmızı	sarı

BILGI

Bu, A ortamı için bir üründür. Ev ortamında kullanılması halinde bu cihaz, istenmeyen parazitlere yol açabilir. Bu durumda kullanıcı uygun önlemler almaya mecbur bırakılabilir.

Hızlıca ilk çalıştırma talimatı

ÖNEMLİ DİKKAT

Maddi hasar tehlikesi.

Boştaki kısaçılara bağlantı yasaktır.

İşlem	Yol verme (Start) parametresi		
	Ayar önerisi	Start gerilimi %	Yol verme süresi sn
Sevk şeridi		70	10
Döner sevk tertibatı		60	10
Kompresör		50	20
Küçük vantilatör		40	20
Pompa		40	10
Hidrolik pompa		40	10
Karıştırma tertibatı		40	20

ÖNEMLİ DİKKAT

Maddi hasar tehlikesi.

Devre sıklığına dikkat ediniz (Bkz. Katalog, Teknik veriler).
Çokyüksek devre sıklığı, yumuşak yol vericiye hasar verir.

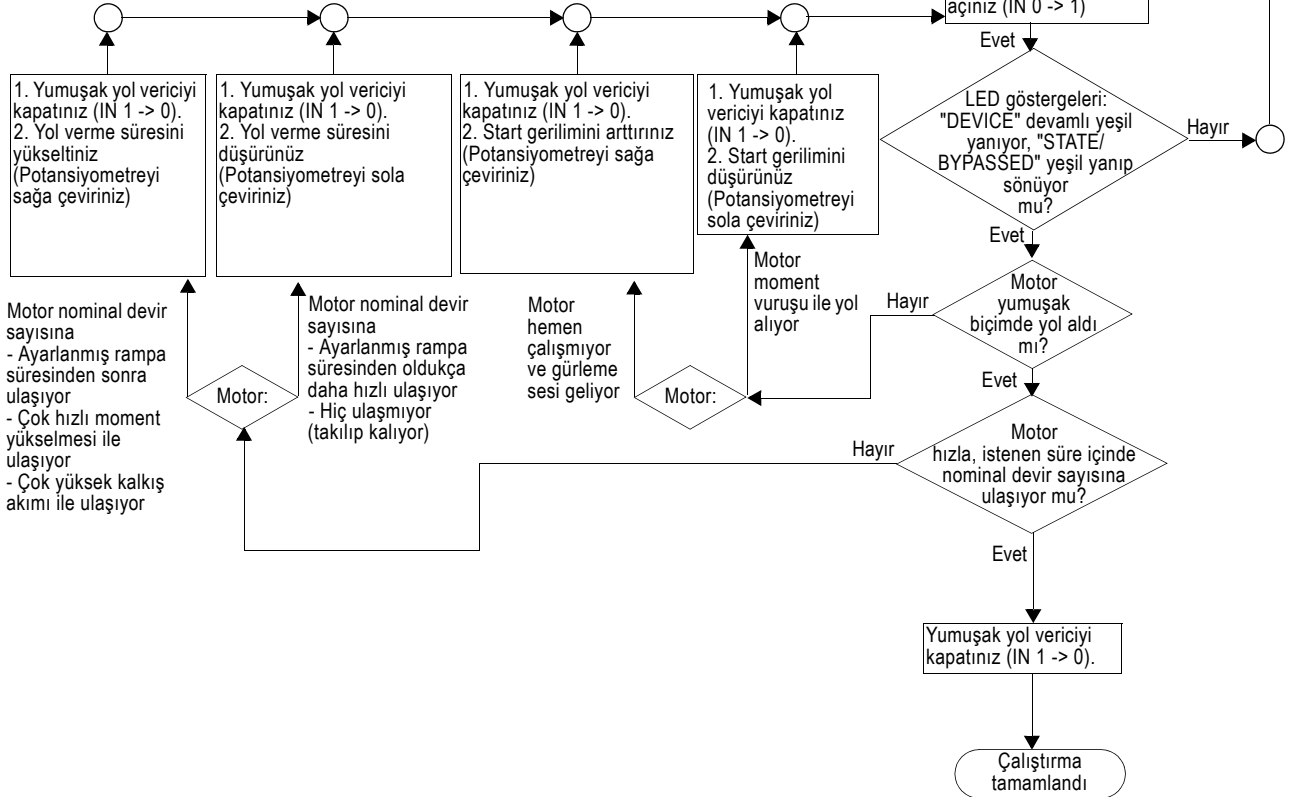

Перед установкой, вводом в эксплуатацию или обслуживанием устройства необходимо прочесть и понять данное руководство.

ОПАСНО

Опасное напряжение. Опасность для жизни или возможность тяжелых травм.
Перед началом работ отключить подачу питания к установке и к устройству.

ОСТОРОЖНО

Безопасность работы устройства гарантировано только при использовании сертифицированных компонентов.

ОПАСНО

Опасное напряжение. Опасность для жизни или опасность получения тяжелых травм.
Во избежание получения электрического удара или сильного ожога нельзя прикасаться к клеммам устройства управления двигателем, когда прибор находится под напряжением. На выходных клеммах имеется напряжение, даже если устройство управления двигателем находится в выключенном состоянии.

Расстояния при встраивании (расположение плотно друг к другу см. в руководстве пользователя к прибору для плавного запуска)

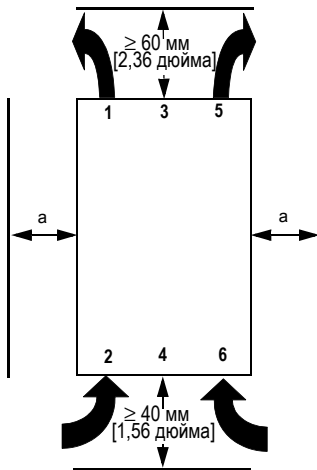

ВНИМАНИЕ

Учтите при встраивании прибора указанные расстояния, чтобы для его охлаждения было достаточно циркулирующего воздуха. Прибор вентилируется снизу вверх.

ОСТОРОЖНО

Опасность повреждения материальных ценностей.
Следите за тем, чтобы в прибор для плавного запуска двигателей не попадали жидкость, пыль или проводящие предметы.

- a) 3RW301; 3RW302: 15 мм [0.59 дюйма]
3RW303; 3RW304: 30 мм [1.18 дюйма]

Обзор индикаторов

		Светодиодная индикация 3RW30		Вспомогательный контакт
		Прибор для плавного запуска двигателей		
3RW30		DEVICE (rd / gn / ylw)	STATE / BYPASSED / FAILURE (gn / rd)	13 14 (ON)
$U_s = 0$		●	●	— / —
Рабочее состояние	IN			
Выкл	0	☀ gn	●	— / —
Запуск	1	☀ gn	◐ gn	— / —
Bypassed	1	☀ gn	☀ gn	— / —
Неисправность				
Недопустимое напряжение питания электроники		●	☀ rd	— / —
Перегрузка байпаса		☀ ylw	☀ rd	— / —
- отсутствует напряжение нагрузки - выпадение фазы, отсутствует нагрузка		☀ gn	☀ rd	— / —
Неисправность прибора		☀ rd	☀ rd	— / —

Показания светодиодов					
●	☀	◐	gn	rd	ylw
			=	=	=
выкл	вкл	мигающий	зеленый	красный	желтый

Русский

Указание

Данный продукт рассчитан на использование в условиях окружающей среды А. В домашних условиях использование данного прибора может привести к нежелательным радиопомехам. В данном случае пользователь может быть обязан принять соответствующие меры.

Руководство для быстрого запуска в эксплуатацию

ОСТОРОЖНО

Опасность повреждения материальных ценностей.
Подключение к свободным клеммам не допустимо.

Предложение по настройке	Параметры запуска	
	Стартовое напряжение %	Время запуска, с
Применение		
Ленточный конвейер	70	10
Роликовый транспортер	60	10
Компрессор	50	20
Небольшой вентилятор	40	20
Насос	40	10
Гидравлический насос	40	10
Мешалка	40	20

ОСТОРОЖНО

Опасность повреждения материальных ценностей.
Необходимо учитывать частоту включений (смотри технические данные в каталоге). Слишком высокая частота включений может привести к повреждениям прибора для плавного запуска.

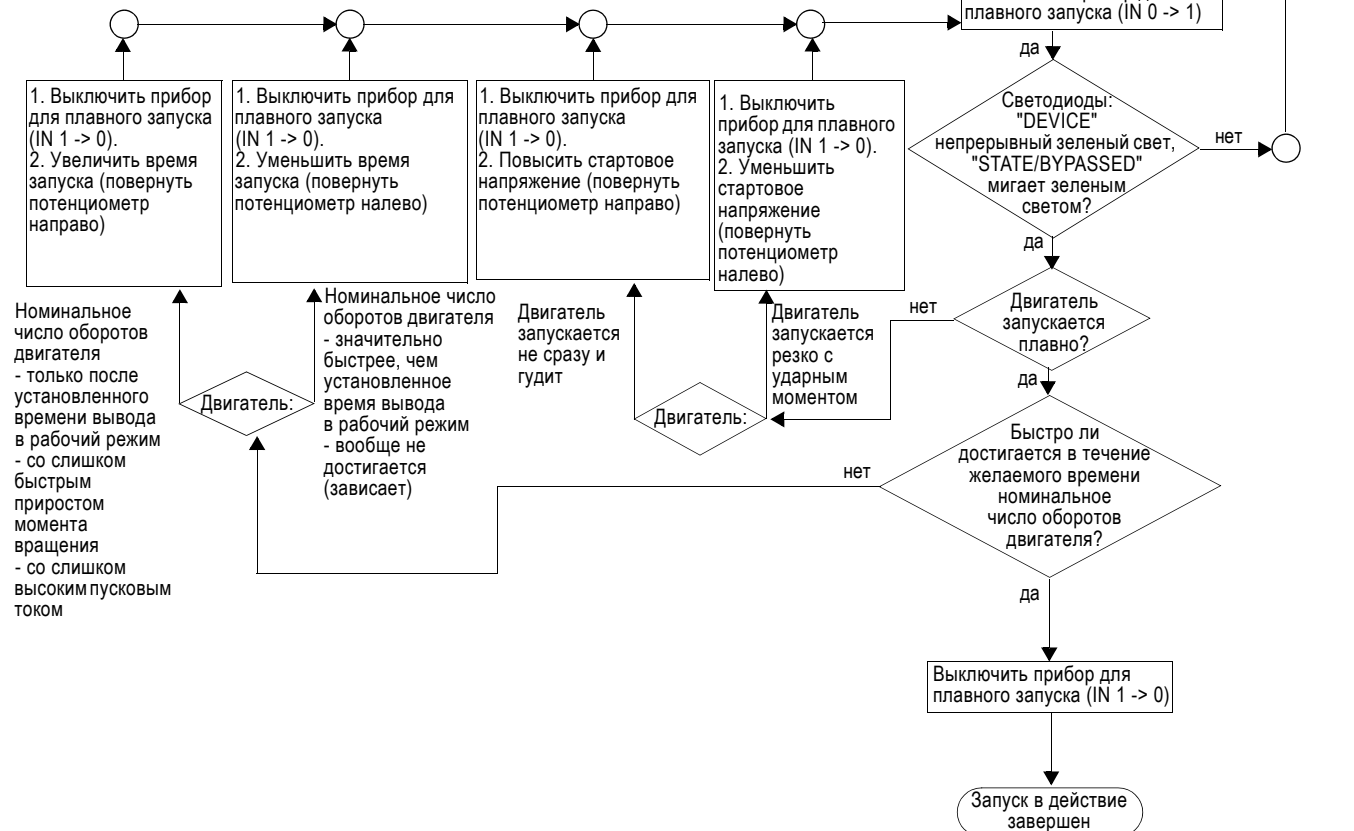

安装、使用和维修本设备前必须先阅读并理解本说明。

⚠ 危险



危险电压。
可能导致生命危险或重伤危险。
操作设备时必须确保切断电源。

小心

只有使用经过认证的部件才能保证设备的正常运转。

⚠ 危险



危险电压。可能导致生命危险或重伤危险。
为了避免受到电击或烧伤，机器有电压时，不去触摸电机控制器的接线端。电机控制器在关机状态时，输出接线端处也有电压。

单个启动器的安装间距（多个启动器安装布局参见软启动器手册）

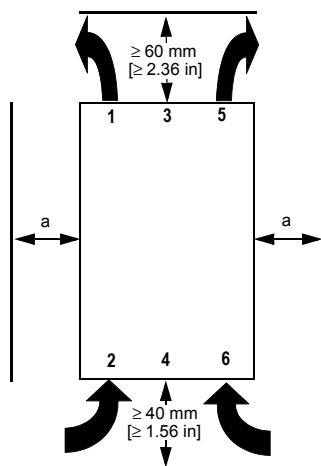

注意

在安装此机器时，一定要注意规定的间距，以此保证足够的冷却空气流通。此机器是从下往上通风的。

小心

设备损坏危险。
一定要注意不要有液体、灰尘或导电物体进入软启动器里面。

a) 3RW301; 3RW302: 15 mm [0.59 in]
3RW303; 3RW304: 30 mm [1.18 in]

显示器及按钮一览

		LED- 显示 3RW30		辅助开关
		软启动器		
3RW30		DEVICE (rd / gn / ylw)	STATE / BYPASSED / FAILURE (gn / rd)	13 14 (ON)
U _s = 0		●	●	— / —
运转状态	开			
关	0	☀ gn	●	— / —
启动	1	☀ gn	◐ gn	— / —
旁通	1	☀ gn	☀ gn	— / —
故障				
电子部件禁止用供电电压		●	☀ rd	— / —
旁通过负荷		☀ ylw	☀ rd	— / —
- 缺少负载电压 - 断相, 缺负荷		☀ gn	☀ rd	— / —
设备故障		☀ rd	☀ rd	— / —

LED 灯显示			gn	rd	ylw
●	☀	◐	=	=	=
关	开	闪烁	绿色	红色	黄色

提示

这是一款适合于环境 A 的产品。在家用环境下，此设备可引起所不希望的无线电干扰。在出现这种情况时，用户可能需要担负起实行相应措施的责任。

快捷式首次启用规程

小心

物品损坏危险。
不允许连接到用不上的接线端上。

参考设定	启动参数	
使用目的	启动电压 %	启动时间 s
传送带	70	10
滚子传送带	60	10
压缩机	50	20
小风扇	40	20
泵	40	10
液压泵	40	10
搅动装置	40	20

小心

物品损坏危险。
请注意开关操作频率度（参见技术参数目录）。
过高的开关操作频率会损坏软启动器。

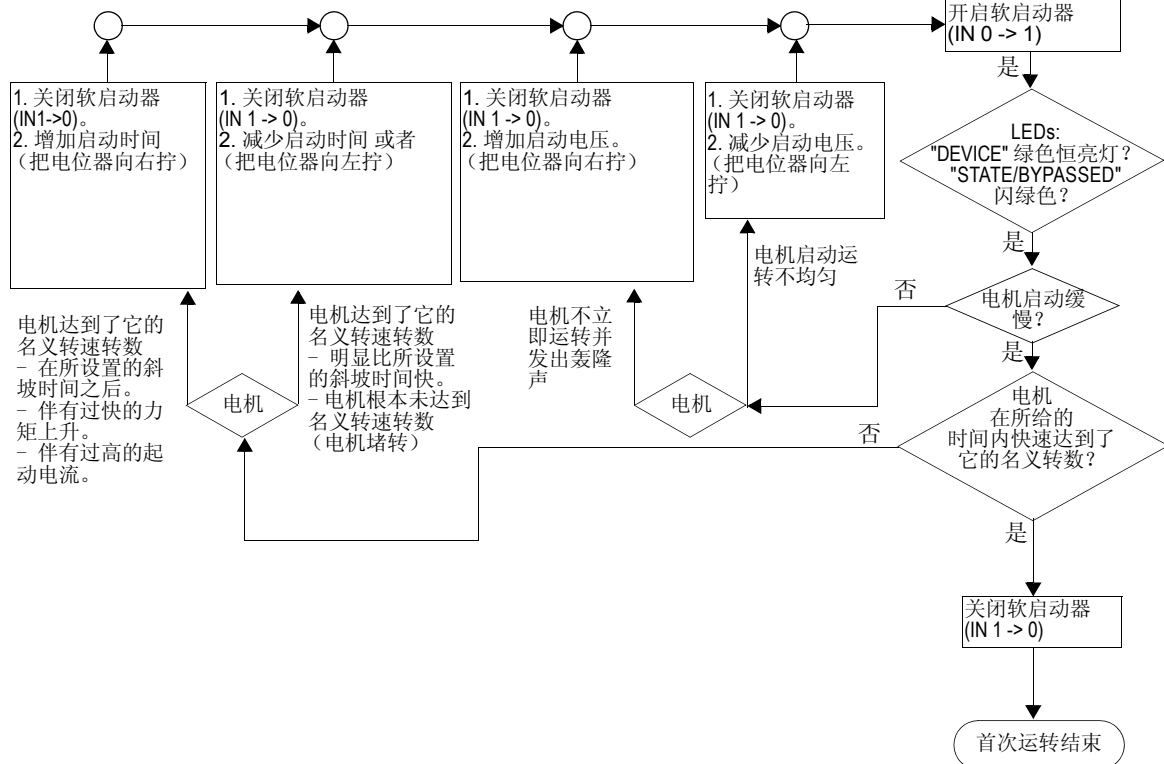

1.

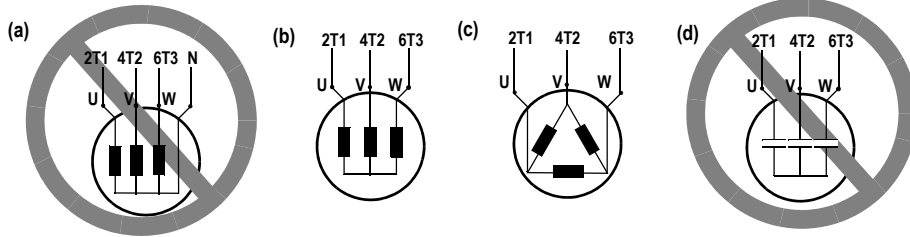

IEC

NEMA

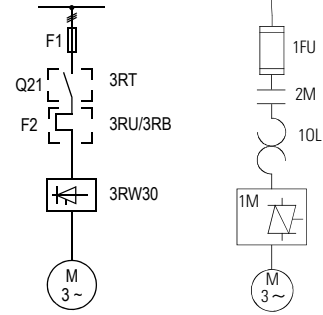

2.

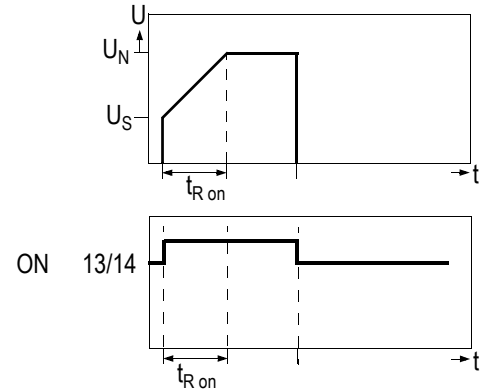
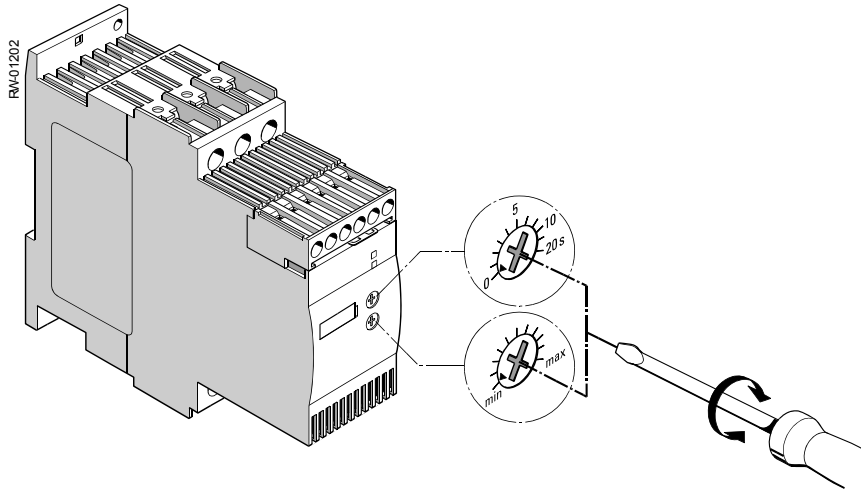

3.

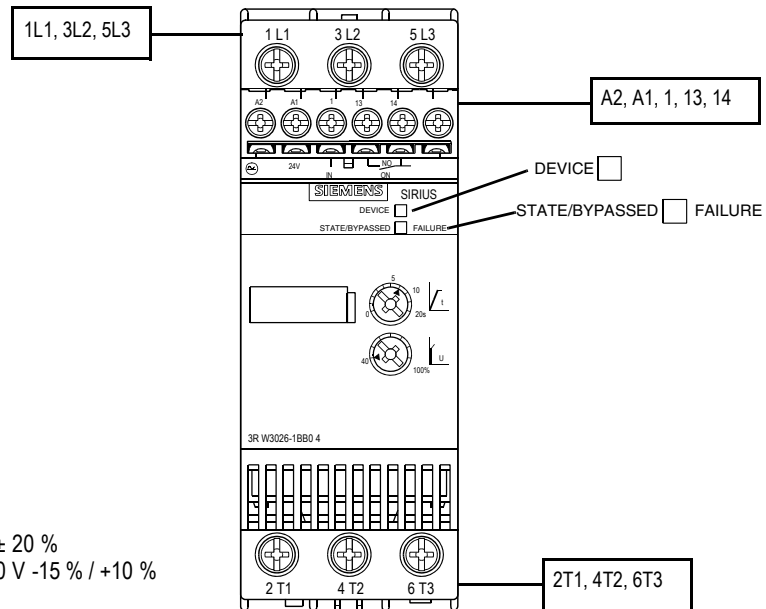
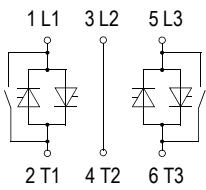

U_S : 3RW30...-BB04: $\approx 24 \text{ V} \pm 20 \%$
 3RW30...-BB14: $\approx 110 \dots 230 \text{ V} -15 \% / +10 \%$

4.

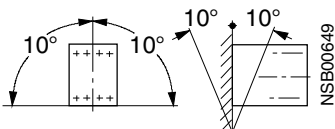

5.

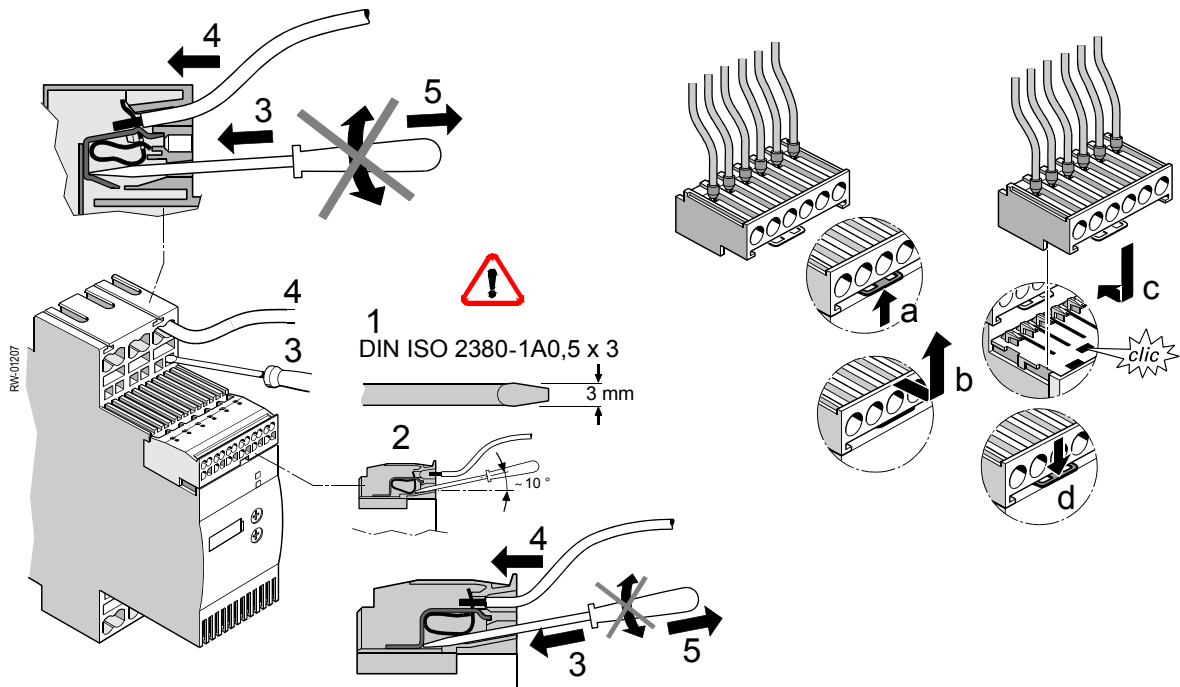

6.

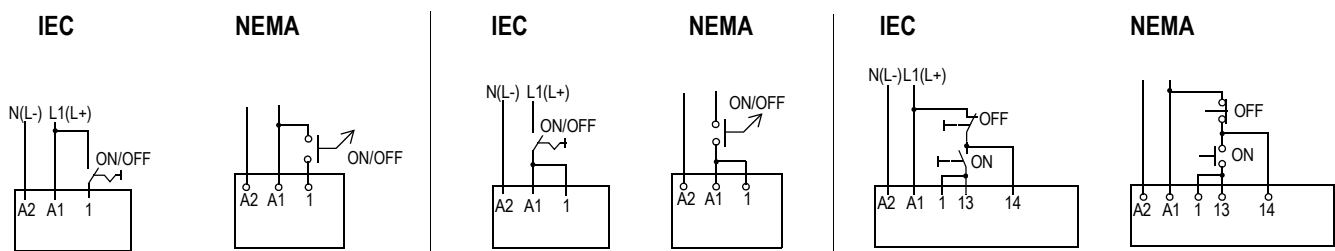

7.

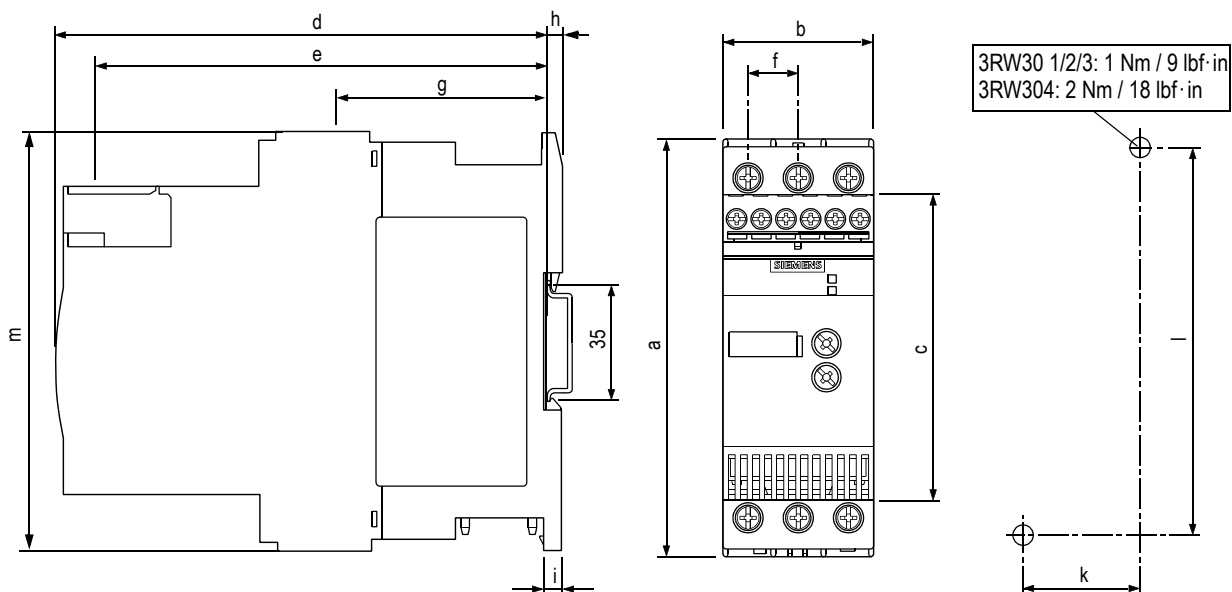

	a	b	c	d	e	f	g	h	i	k	l	m
3RW301-1....	95 (3.74)	45 (1.77)	62 (2.44)	146 (5.75)	126 (4.96)	14,4 (0.57)	63 (2.48)	5 (0.20)	6,5 (0.26)	35 (1.38)	85 (3.35)	95 (3.74)
3RW301-2....	95 (3.74)	45 (1.77)	62 (2.44)	146 (5.75)	144 (5.67)	14,4 (0.57)	84,3 (3.32)	5 (0.20)	6,5 (0.26)	35 (1.38)	85 (3.35)	117,2 (4.61)
3RW302	125 (4.92)	45 (1.77)	92 (3.62)	146 (5.75)	126 (4.96)	14,4 (0.57)	63 (2.48)	5 (0.20)	6,5 (0.26)	35 (1.38)	115 (4.53)	125 (4.92)
3RW302-2....	125 (4.92)	45 (1.77)	92 (3.62)	146 (5.75)	144 (5.67)	14,4 (0.57)	90,5 (3.56)	5 (0.20)	6,5 (0.26)	35 (1.38)	115 (4.53)	150 (5.90)
3RW303	160 (6.30)	55 (2.17)	110 (4.33)	163 (6.42)	140 (5.51)	18 (0.71)	63 (2.48)	5 (0.20)	6,5 (0.26)	30 (1.18)	150 (5.91)	144 (5.67)
3RW304	170 (6.69)	70 (2.76)	110 (4.33)	181 (7.13)	158 (6.22)	22,5 (0.89)	85 (3.35)	5 (0.20)	10 (0.39)	60 (2.36)	160 (6.3)	160 (6.3)

mm (inch)

8.

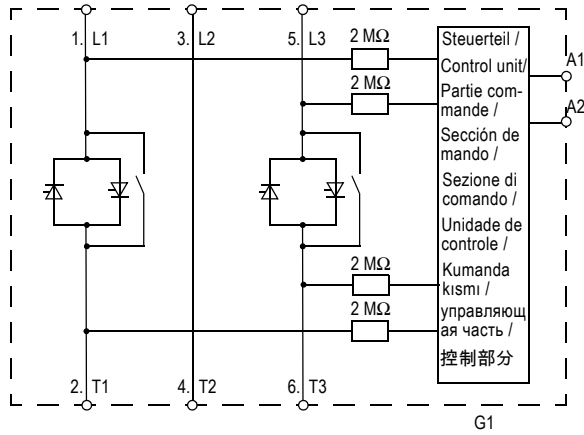

DE	Last- und Steuerstromkreis sind nicht galvanisch getrennt. Es besteht eine hochohmige Verbindung.
EN	Load current circuit and control current circuit are not galvanically isolated. A high-ohmic connection is present.
FR	Les circuits de charge et de commande ne sont pas séparés galvaniquement. Il existe un raccordement à haute impédance.
ES	Los circuitos de carga y de mando no tienen aislamiento galvánico. Está presente una conexión de alta impedancia.
IT	Circuito di carico e di comando non separati galvanicamente. È presente un collegamento ad alta resistenza.
PT	Os circuitos de corrente de carga e de comando não estão separados galvanicamente. Existe uma conexão de alta impedância.
TR	Yük ve kontrol devreleri galvanik olarak ayrılmış değildir. Yüksek ohmik bağlantı mevcuttur.
PY	Цели тока нагрузки и управления гальванически не разомкнуты. Существует высокоомное соединение.
中文	负载电路和控制电路间没有被绝缘隔离。它们之间存在着高欧姆值的连接。