

Specifications

Pitch:	5.0mm
Type:	Rising Clamp
Poles:	2 to 12
Rated Voltage:	See Table
Rated Current:	See Table
Operational Temperature:	-40°C to +105°C
Withstand Voltage:	2000V AC for 60s
Insulation Resistance:	500MΩ at 500V DC
Wire Range:	See Table
Wire Stripping Length:	5-6mm ± 0.5mm
Screw Size:	M3
Max. Torque Value:	0.5Nm
Wave Soldering:	260°C for 5s
Hand Soldering:	350°C for 10s

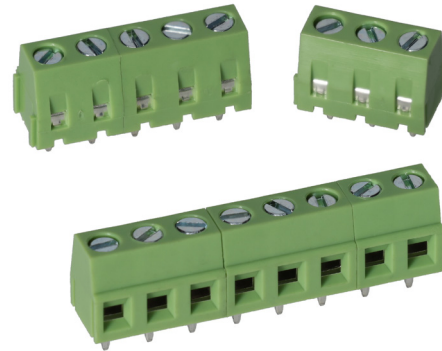

Order Code	Poles	Order Code	Poles
21-1833	2	21-1838	8
21-1834	3	21-1807	9
21-1835	4	21-1839	10
21-1836	5	21-1808	11
21-1837	6	21-1840	12
21-1806	7		

Colour and Materials

Housing Colour:	Green
Housing Material:	PA66
Flame Retardancy:	UL94-V0
Screw:	Zinc-plated steel (A3)
Wire Cage:	Nickel-plated brass
Pin Header:	Tin-plated brass

Standard	Rated Voltage	Rated Current	Wire Range
UL	300V	12A	26-14AWG (0.14-2.5mm ²)
IEC	250V	15A	1.5mm ²

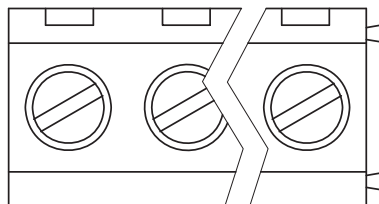
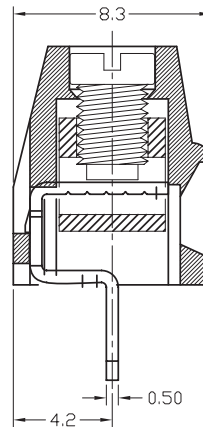
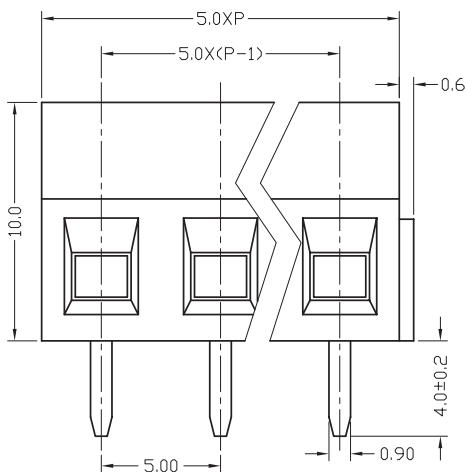

Measurements are in mm unless stated otherwise.

