

Sample set - SAMPLE DMC 0,5/ 7-G1-2,54 THR - 1859547

Please be informed that the data shown in this PDF Document is generated from our Online Catalog. Please find the complete data in the user's documentation. Our General Terms of Use for Downloads are valid (<http://phoenixcontact.com/download>)

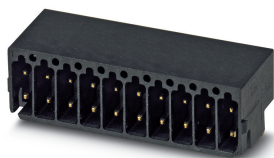

The figure shows a 10-pos. version with 20 contacts

PCB header, nominal cross section: 0.5 mm², color: black, nominal current: 6 A, rated voltage (III/2): 160 V, contact surface: Gold, type of contact: Male connector, Number of potentials: 14, Number of rows: 2, Number of positions per row: 7, number of connections: 14, product range: DMC 0,5/...-G1-THR, pitch: 2.54 mm, mounting: THR soldering, solder pin [P]: 2 mm, plug-in system: MICRO COMBICON - DFMC 0,5, Locking: without, type of packaging: packed in cardboard

Your advantages

- Gold-plated contacts ensure transfer quality remains stable over the long term
- Designed for integration into the SMT soldering process
- Conductor connection on several levels enables higher contact density
- Small component size for applications where space is at a premium
- Supplied in tape-on-reel packing according to IEC 60286-3 for automated mounting

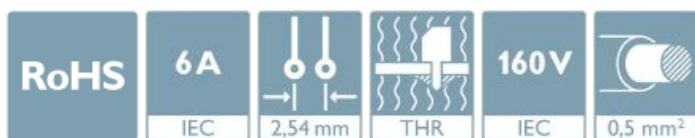

Key Commercial Data

Packing unit	5 pc
Minimum order quantity	5 pc
GTIN	
GTIN	4055626111940
Weight per Piece (excluding packing)	2.500 g
Custom tariff number	85366990
Country of origin	Poland
Sales Key	AAADGB

Technical data

Item properties

Brief article description	Feed-through header
Plug-in system	MICRO COMBICON - DFMC 0,5
Type of contact	Male connector
Range of articles	DMC 0,5/...-G1-THR
Pitch	2.54 mm

Sample set - SAMPLE DMC 0,5/ 7-G1-2,54 THR - 1859547

Technical data

Item properties

Number of positions	7
Mounting type	THR soldering
Locking	without
Number of levels	2
Number of connections	14
Number of potentials	14
Pin connector pattern alignment	Standard

Electrical parameters

Nominal current	6 A
Nom. voltage	160 V
Rated voltage (III/3)	32 V
Rated voltage (III/2)	160 V
Rated voltage (II/2)	160 V
Rated surge voltage (III/3)	2.5 kV
Rated surge voltage (III/2)	2.5 kV
Rated surge voltage (II/2)	2.5 kV

Material data - contact

Note	WEEE/RoHS-compliant, free of whiskers according to IEC 60068-2-82/ JEDEC JESD 201
Contact material	Cu alloy
Surface characteristics	Completely gold-plated
Metal surface contact area (top layer)	Gold (0.25 Au)
Metal surface contact area (middle layer)	Nickel (2 - 4 µm Ni)
Metal surface soldering area (top layer)	Gold (0.25 Au)
Metal surface soldering area (middle layer)	Nickel (2 - 4 µm Ni)

Material data - housing

Housing color	black (9005)
Insulating material	LCP
Insulating material group	IIIa
CTI according to IEC 60112	175
Flammability rating according to UL 94	V0

Dimensions for the product

Caption	Schematische Abbildung - weitere Details siehe Produktfamilienzeichnung im Download Center
Length [l]	9.64 mm
Width [w]	18.28 mm
Height [h]	7.39 mm
Pitch	2.54 mm
Solder pin [P]	2 mm
Pin spacing	2.54 mm

Sample set - SAMPLE DMC 0,5/ 7-G1-2,54 THR - 1859547

Technical data

Dimensions for the product

Pin dimensions	0.64 x 0.64 mm
----------------	----------------

Dimensions for PCB design

Hole diameter	1.2 mm
Pin spacing	2.54 mm

Packaging information

Type of packaging	packed in cardboard
Pieces per package	5
Denomination packing units	Pcs.

Processing notes

Process	Reflow/wave soldering
Specification	Following IPC/JEDEC J-STD-020D.1:2008-03
	Following IEC 61760-1:2006-04
	Following IEC 60068-2-58:2005-02
Moisture Sensitive Level	MSL 1
Classification temperature T _c	260 °C
Solder cycles in the reflow	3

Ambient conditions

Ambient temperature (storage/transport)	-40 °C ... 70 °C
Ambient temperature (assembly)	-5 °C ... 100 °C
Ambient temperature (operation)	-40 °C ... 100 °C (dependent on the derating curve)

Air clearances and creepage distances

Clearances and creepage distances	IEC 60664-1:2007-04
Specification	IEC 60664-1:2007-04
Minimum clearance - inhomogeneous field (III/3)	1.5 mm
Minimum clearance - inhomogeneous field (III/2)	1.5 mm
Minimum clearance - inhomogeneous field (II/2)	1.5 mm
Minimum creepage distance value (III/3)	1.3 mm
Minimum creepage distance value (III/2)	1.6 mm
Minimum creepage distance value (II/2)	1.6 mm

Mechanical tests (A)

Test specification	IEC 61984
Insertion strength per pos. approx.	2 N
Withdraw strength per pos. approx.	1 N
Polarization when inserted requirement >20 N	Test passed
Contact holder in insert requirements >20 N	Test passed

Durability tests (B)

Specification	IEC 60512-9-1:2010-03
Contact resistance R ₁	2.7 mΩ

Sample set - SAMPLE DMC 0,5/ 7-G1-2,54 THR - 1859547

Technical data

Durability tests (B)

Insertion/withdrawal cycles	100
Contact resistance R ₂	2.9 mΩ
Contact resistance R ₂ 2nd level	3.1 mΩ
Impulse withstand voltage at sea level	2.95 kV

Thermal tests (C)

Specification	IEC 60512-5-1:2002-02
Number of positions	16
Upper limiting temperature requirements <100 °C	Test passed

Climatic tests (D)

Specification	DIN 50018:2013-05
Cold stress	-40 °C/2 h
Thermal stress	100 °C/168 h
Corrosive stress	1.0 dm ³ SO ₂ on 300 dm ³ /40 °C/3 cycles
Impulse withstand voltage at sea level	2.95 kV
Power-frequency withstand voltage	1.39 kV

Environmental and durability tests (E)

Specification	IEC 61984:2008-10
Result, degree of protection, IP code	Finger safety with IP20 test finger

Vibration test

Specification	IEC 60068-2-6:2007-12
Frequency	10 - 500 - 10 Hz
Sweep speed	1 octave/min
Amplitude	0.35 mm (10 - 60.1 Hz)
Acceleration	5g (60.1 - 500 Hz)
Test duration per axis	2 h

Standards and Regulations

Connection in acc. with standard	EN-VDE
Flammability rating according to UL 94	V0

Environmental Product Compliance

China RoHS	Environmentally friendly use period: unlimited = EFUP-e
	No hazardous substances above threshold values

Drawings

Sample set - SAMPLE DMC 0,5/ 7-G1-2,54 THR - 1859547

Drilling diagram

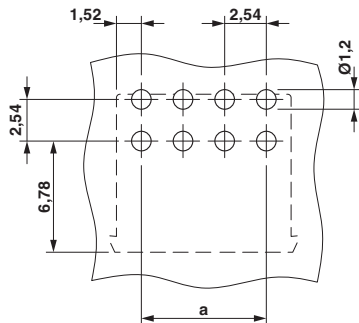

Diagram

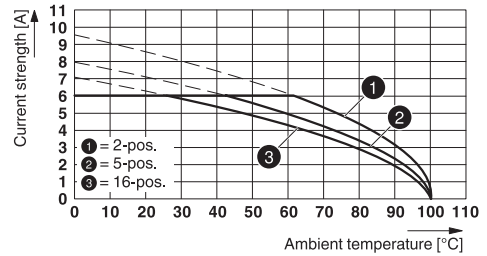

Type: DFMC 0,5/...-ST-2,54 with DMC 0,5/...-G1-2,54 P...THR R...

Diagram

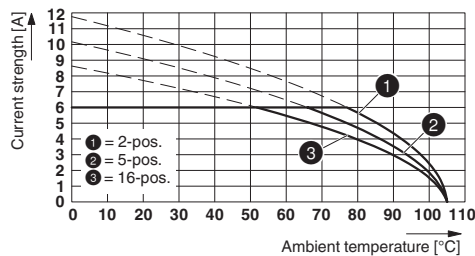

Type: DMCC 0,5/...-ST-2,54 with DMC 0,5/...-G1-2,54 P...THR R...

Diagram

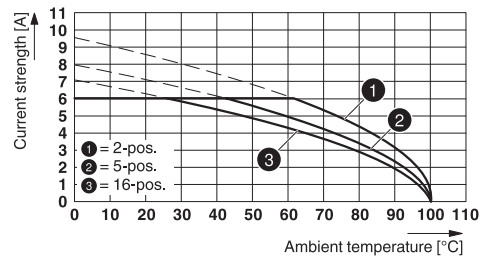

Type: DFMC 0,5/...-ST-2,54-RF with DMC 1,5/...-G1-2,54 P...THR R...

Dimensional drawing

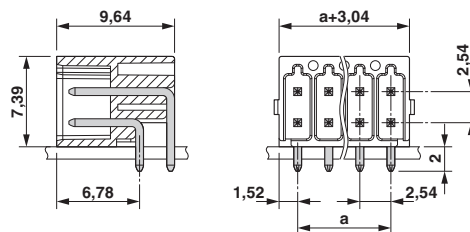

Classifications

eCl@ss

eCl@ss 10.0.1	27440402
eCl@ss 11.0	27460201
eCl@ss 4.0	27260700
eCl@ss 4.1	27260700
eCl@ss 5.0	27260700
eCl@ss 5.1	27260700
eCl@ss 6.0	27260700
eCl@ss 7.0	27440402
eCl@ss 9.0	27440402

Sample set - SAMPLE DMC 0,5/ 7-G1-2,54 THR - 1859547

Classifications

ETIM

ETIM 6.0	EC002637
ETIM 7.0	EC002637

UNSPSC

UNSPSC 13.2	39121409
UNSPSC 18.0	39121409
UNSPSC 19.0	39121409
UNSPSC 20.0	39121409
UNSPSC 21.0	39121409

Approvals

Approvals

Approvals

EAC

Ex Approvals

Approval details

EAC		B.01687
-----	--	---------

Accessories

Accessories

Labeled terminal marker

Marker card - SK 2,54/2,8:FORTL.ZAHLEN - 0804853



Marker card, Card, white, labeled, horizontal: consecutive numbers 1 ... 10, 11 ... 20, etc. up to 91 ... 99, mounting type: adhesive, for terminal block width: 2.54 mm, lettering field size: 2.54 x 2.8 mm

Additional products

Sample set - SAMPLE DMC 0,5/ 7-G1-2,54 THR - 1859547

Accessories

Printed-circuit board connector - DFMC 0,5/ 7-ST-2,54 - 1844620



Plug, nominal current: 6 A, rated voltage (III/2): 160 V, number of positions: 7 with 14 contacts, pitch: 2.54 mm, connection method: spring connection, color: black, contact surface: gold