

Data sheet | Item number: 288-601

Lateral cover; Size 1; small; 6.35 mm thick

[www.wago.com/288-601](http://www.wago.com/288-601)

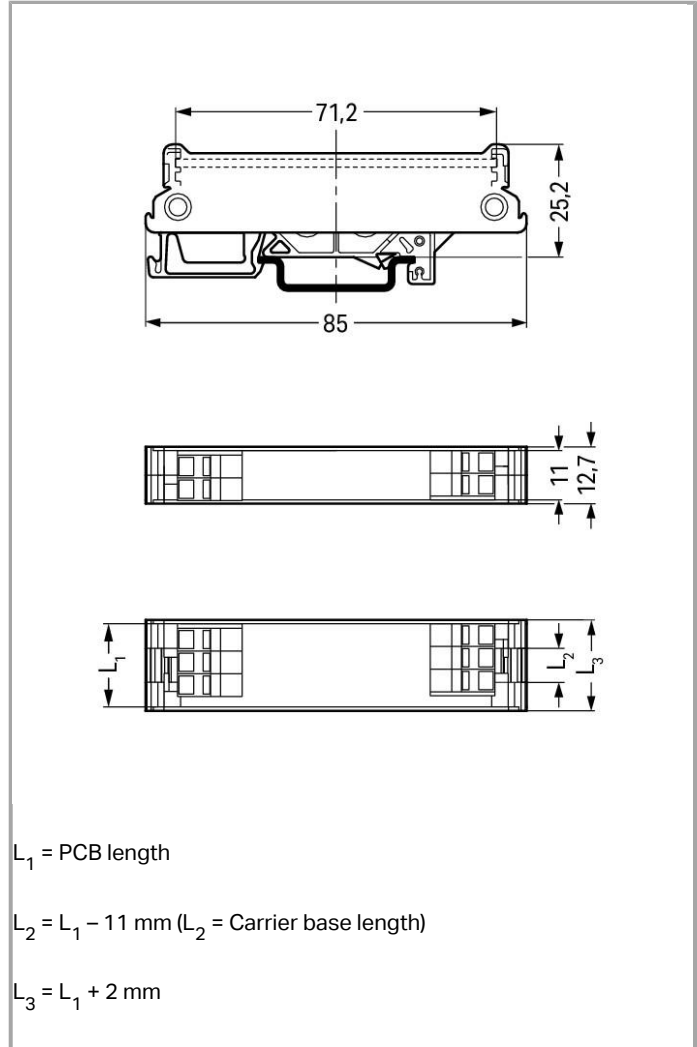

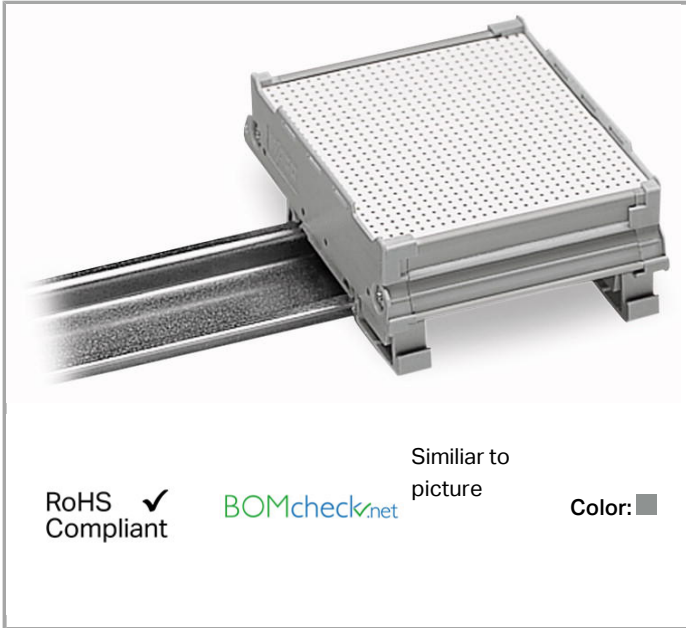
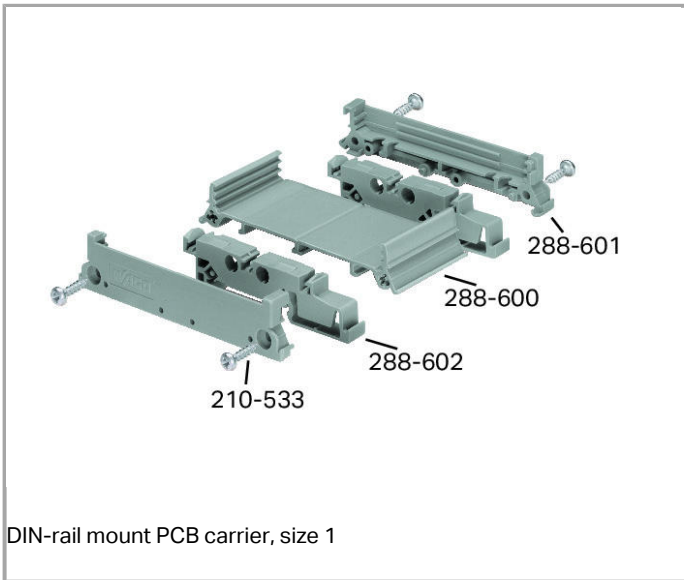

### Item description

DIN-rail mount PCB carrier, size 1 – lateral cover, size 1; small; 6.35 mm thick

### Data

#### Geometrical Data

Width	6.35 mm / 0.25 inch
Depth	85 mm / 3.346 inch

#### Mechanical data

Type of mounting	DIN-35 rail
------------------	-------------

#### Material Data

Color	gray
Fire load	0.102 MJ
Weight	3.28 g

Subject to changes.