

Printview: 4-conductor chassis-mount terminal strip; for mounting via M3 screw and nut or self-tapping screw 2.9 mm Ø from top; plain; without ground contact; 3-pole - Item No.: 862-503



4-conductor chassis-mount terminal strip; for mounting via M3 screw and nut or self-tapping screw 2.9 mm Ø from top; plain; without ground contact; 3-pole

Item No.: 862-503



4-conductor chassis-mount terminal strip; for mounting via M3 screw and nut or self-tapping screw 2.9 mm Ø from top; plain; without ground contact; 3-pole

Marking

RoHS ✓
Compliant

Business data

Supplier	WAGO
Item no.	862-503
GTIN / EAN	4044918509008
Content	1

Notes

Technical data

Miscellaneous

Rated voltage (III / 3) [V]	500 [V]
Rated impulse voltage (III / 3) [kV]	6 [kV]
Rated current [A]	32 [A]
Legend (ratings)	(III / 3) Overvoltage category III / Pollution degree 3
Type of wiring	Side-entry wiring

Printview: 4-conductor chassis-mount terminal strip; for mounting via M3 screw and nut or self-tapping screw 2.9 mm Ø from top; plain; without ground contact; 3-pole - Item No.: 862-503

Technical data	
<i>No. of poles</i>	3
<i>Total number of connection points</i>	12
<i>Total number of potentials</i>	3
<i>Connection technology</i>	Push-in CAGE CLAMP®
<i>Actuation type</i>	Operating tool
<i>Connectable conductor materials</i>	Copper
<i>Solid conductor</i>	0.5 ... 4 mm ² / 20 ... 12 AWG
<i>Solid conductor, push-in termination</i>	0.5 ... 4 mm ² / 20 ... 12 AWG
<i>Stranded conductor</i>	0.5 ... 4 mm ² / 20 ... 12 AWG
<i>Fine-stranded conductor</i>	0.5 ... 4 mm ² / 20 ... 12 AWG
<i>Fine-stranded conductor with ferrule with plastic collar</i>	0.5 ... 2.5 mm ² / 20 ... 12 AWG
<i>Fine-stranded conductor with ferrule, push-in termination, f</i>	0.5 mm ² / 20 AWG
<i>Strip length</i>	10 ... 11 mm / 0.39 ... 0.43 Inch
<i>Pin spacing</i>	12 mm / 0.472 in
<i>Width</i>	36 mm / 1.417 Inch
<i>Height from the surface</i>	22.3 mm / 0.878 Inch
<i>Depth</i>	35 mm / 1.378 Inch
<i>Mounting type</i>	Screw mounting
<i>Marking</i>	without marking
<i>Color</i>	black
<i>Fire load [MJ]</i>	0.383 [MJ]
<i>Weight [g]</i>	20.488 [g]
<i>Pin spacing up to [in]</i>	0.472 [in]
<i>Pin spacing up to [mm]</i>	12 [mm]
<i>Pin spacing from [in]</i>	0.472 [in]
<i>Pin spacing from [mm]</i>	12 [mm]
<i>Main product function</i>	Chassis-mount terminal strip
<i>Product type</i>	Field-wiring terminal blocks

Printview: 4-conductor chassis-mount terminal strip; for mounting via M3 screw and nut or self-tapping screw 2.9 mm Ø from top; plain; without ground contact; 3-pole - Item No.: 862-503

Images & drawings



Printview: 4-conductor chassis-mount terminal strip; for mounting via M3 screw and nut or self-tapping screw 2.9 mm Ø from top; plain; without ground contact; 3-pole - Item No.: 862-503

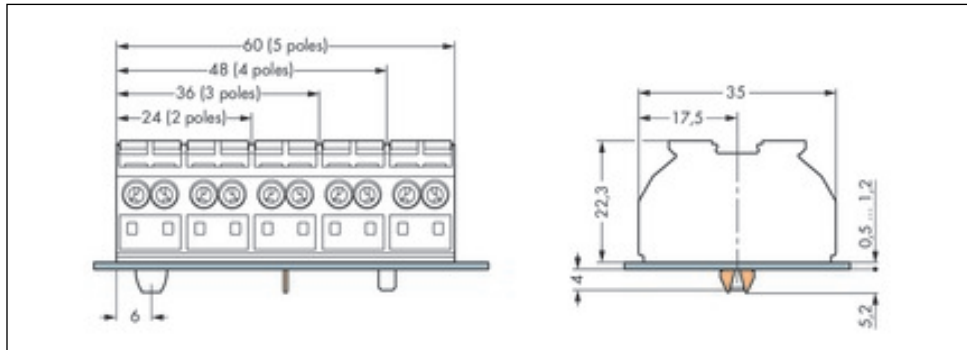

Address

WAGO Kontakttechnik GmbH & Co. KG

Hansastr. 27

32423 Minden

Telefon: 0571/887-0

Fax: 0571/887-169

<http://www.wago.com>

© WAGO Kontakttechnik GmbH & Co. KG

Technische Änderungen und Irrtümer vorbehalten.