

承認書
APPROVED DATA

客戶
CUSTOMERS

RAPID ELECTRONICS LTD

品名

DESCRIPTION: AC SOCKET

力瑋料號

INALWAYS P/N: 0717-1S-PQ12N-A (of 0717-1S Series)

客戶料號

CUSTOMER P/N: 23-3211

日期

DATE 2013 年 6 月 7 日

承認印 APPROVED BY



TITLE : AC INLET 3P WITH FUSEHOLDER

Part No. : 0717-1S Series

TABLE OF CONTENTS

1. Scope 應用範圍
2. Electrical Rating 額定電流/電壓
3. Materials and Construction 材質與結構
 - 3.1 Materials 材質
 - 3.2 Construction 結構
 - 3.3 Operating Temperature 工作溫度
 - 3.4 Performance and Procedures 性能及程序
4. Test Requirement and Procedures 測試條件及程序
5. Test Sequences 測試順序
6. Certified Safety 認證安規

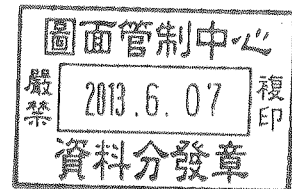

DOCUMENT NO.	REV	DESCRIPTION	APPROVED BY	CHECKED BY	WRITTEN BY	DATE (yyyy/mm/dd)	SHT NO.
E717-2003	A	NEW RELEASE				2012/03/15	1 OF 6



1. Scope 應用範圍

This specification applies to AC Inlet 3P with Fuseholder for case mount of the following rated for Cold condition, for class I equipment only, in accordance of IEC 60320-1, EN 60320-1, IEC 60127-6, EN 60127-6, UL 498 and CSA C22.2. The pins temperature should not exceed to 70 °C.

本規範適用於冷狀態一級設備之3P插座，依照 IEC 60320-1、EN 60320-1、IEC 60127-6、EN 60127-6、UL 498 及 CSA C22.2等規範，插座內插梢之溫度不可超過 70 °C。

2. Electrical Rating 額定電流/電壓

North America 北美： 10 A 250 V ~

Europe 歐洲： 10 A 250 V ~

3. Materials and Construction 材質與結構

3.1 Materials 材質

Frame： Thermoplastic, PC, UL 94V-0 架構:熱塑性塑膠, 聚碳酸酯

Pin & Terminals： Copper alloy, Tin plated 插梢 & 端子：黃銅，鍍錫

3.2 Construction 結構

See the figure. 見附圖

3.3 Operating Temperature 工作溫度

- 25 °C to + 70 °C

3.4 Performance and Procedures 性能及程序

Socket shall be designed to meet the electrical, mechanical and environmental performance requirements specified in 4.

插座設計應滿足電氣、機械及環境測試性能需求，詳細規格說明於 4. 節。

TITLE		AC INLET 3P WITH FUSEHOLDER		
DOCUMENT NO.	REV	DESCRIPTION	DATE (yyyy/mm/dd)	SHEET NO.
E717-2003	A	SEE SHEET 1	2012/03/15	2 OF 6



4. Test Requirement and Procedures 測試條件及程序

Electrical Requirements 電氣特性要求		
Item	Requirement	Test Methods
Insulation Resistance 絕緣阻抗	100 M Ω min. 100 M Ω 以上。	500 VDC applied for one minute between adjacent terminals and between adjacent terminals and housing. 測試電壓500 VDC、測試時間1分鐘，在端子與端子間及端子與本體間。 IEC 60320-1, Section 15 IEC 60127-6, Section 11
Electric Strength 耐電壓強度	No Breakdown. 無任何損壞。	A) 2,000 VAC being applied between all terminals for one minute. 在所有端子與端子之間施加 2,000 VAC 測試 1分鐘。 B) 4,000 VAC being applied between all terminals and frame for one minute. 在端子與塑膠本體之間施加 4,000 VAC 測試 1分鐘。 IEC 60320-1, Section 15
Contact Resistance 接觸阻抗	(A) <u>For Socket only</u> 30 m Ω max. 30 m Ω 以內。 (B) <u>For Fuseholder only</u> 10 m Ω max. 10 m Ω 以內。	Mate connectors, apply maximum voltage of 5 V and a current of 100 mA. 將連接器匹配後，以測試電壓最大5 V，電流最大100 mA。 IEC 60127-6
Temperature Rise 溫昇測試	85°C max. 溫度85°C 以下。	A sustained dissipation 1.6 W /10A is passed through the specimen, measure 3 successive readings, at least 10 min apart, unit temperature stability. 樣品持續施加1.6W/10A電流，在溫度穩定後量測3次數值，中間最少間隔10分鐘。 IEC 60127-6, SECTION 13

TITLE	AC INLET 3P WITH FUSEHOLDER			
DOCUMENT NO.	REV	DESCRIPTION	DATE (yyyy/mm/dd)	SHEET NO.
E717-2003	A	SEE SHEET 1	2012/03/15	3 OF 6



4. Test Requirement and Procedures 測試條件及程序

Mechanical Requirements 機械特性要求		
Item	Requirement	Test Methods
Pull Force of Terminal 端子推出力	No movement exceeding 2.5 mm. 移動 2.5 mm 以下。	The specimen shall be heated to temperature of 70 °C for 1 hour. Then a static load of 60 N is applied to the pins for one minute. 加熱樣品至 70 °C 維持 1 小時，然後施加 60 牛頓於插梢持續 1 分鐘。 IEC 60320-1, Section 13
Ball-Pressure Test 球壓測試	Measure the diameter of the impression shall not exceed 2 mm. 壓痕直徑最大 2 mm。	The specimen shall be stored at a temperature of 125 ± 2 °C, a steel ball of 5 mm diameter is pressed against the surface of the specimen with a force of 20 N for 1 hour. 產品放在 125 ± 2 °C 的加熱室內，用一直徑 5 mm 的鐵球、作用力 20 N，對產品表面施壓 1 小時。 IEC 60320-1, Section 24
Push-out test 面板推出測試 <i>(For Panel Only)</i>	Specimen cannot be push out from the panel. 樣品不會被推出面板。	The specimen shall be mounted on a panel, then apply a static load of 90N from the back of the specimen for one minute. 樣品固定在面板上，然後施加 90N 於樣品背部持續 1 分鐘。

TITLE	AC INLET 3P WITH FUSEHOLDER			
DOCUMENT NO.	REV	DESCRIPTION	DATE (yyyy/mm/dd)	SHEET NO.
E717-2003	A	SEE SHEET 1	2012/03/15	4 OF 6



4. Test Requirement and Procedures 測試條件及程序

Environment Requirements 環境要求		
Item	Requirement	Test Methods
Moisture Resistance 防潮	No damage. 無任何損傷。	For socket only. Expose the specimens to 40±2 °C, 91 ~ 95 % R.H. for 168 hours. 樣品放在溫度40±2 °C、相對溼度91~95%之測試槽內168小時。 IEC 60320-1, Section 14
		For Fuseholder only. Expose the specimens to 40±2 °C, 91 ~ 95 % R.H. for 48 hours. 樣品放在溫度40±2 °C、相對溼度91~95%之測試槽內48小時。 IEC 60127-6, Section 11
Resistance to Heat 耐熱性	No damage. 無任何損傷。	The specimen shall be stored at a temperature of 100 ± 2 °C for 1 hour. 樣品放在100 ± 2 °C的測試槽內1小時。 IEC 60320-1, Section 24
Solderability 焊錫性	Solder coverage more than 90 %. 端子需披覆錫 90 % 以上。	Manual Soldering 烙鐵焊接 Soldering temperature 380 ± 5 °C, duration 2~3 sec. 烙鐵溫度 380 ± 5 °C，焊接 2~3秒。 IEC 60068-2
Resistance to Solder Heat 抗焊錫熱	No damage. 無任何損傷。	Manual Soldering 烙鐵焊接 Soldering temperature 400 ± 5 °C, duration 5 ± 1 sec. 烙鐵溫度 400 ± 5 °C，焊接 5 ± 1 秒。 IEC 60068-2

TITLE	AC INLET 3P WITH FUSEHOLDER			
DOCUMENT NO.	REV	DESCRIPTION	DATE (yyyy/mm/dd)	SHEET NO.
E717-2003	A	SEE SHEET 1	2012/03/15	5 OF 6



5. Test Sequences 測試順序

The test sequences are defined as following. 測試順序如下：

Test Description	Test Group					
	Socket				Fuseholder	
	1	2	3	Supplemental Test	1	2
Insulation Resistance 絕緣阻抗		2			2	
Electric Strength 耐電壓強度		3			3	
Contact Resistance 接觸阻抗		4				1
Temperature Rise 溫昇測試						2
Pull Force of Terminal 端子推出力	1					
Ball-Pressure Test 球壓測試			2			
Push-Out test 面板推出測試	2					
Moisture Resistance 防潮		1			1	
Resistance to Heat 耐熱性			1			
Solderability 焊錫性				1		
Resistance to Solder Heat 抗焊錫熱	3					
Sample Size for Each Group	3	3	3	3	3	3

6. Certified safety 認證安規

UL / CUL / VDE / ENEC / CCC

TITLE	AC INLET 3P WITH FUSEHOLDER			
DOCUMENT NO.	REV	DESCRIPTION	DATE (yyyy/mm/dd)	SHEET NO.
E717-2003	A	SEE SHEET 1	2012/03/15	6 OF 6

客戶用圖

SPECIFICATION

- A: MATERIAL:
 1. HOUSING: PC, UL 94V-0
 2. TERMINAL: COPPER ALLOY, TIN PLATED
- B: CHARACTERISTICS:
 1. RATING: 10A 250V~ NORTH AMERICA
 10A 250V~ EUROPE
 2. INSULATION RESISTANCE: 100MΩ MIN, AT 500V DC
 3. ELECTRIC STRENGTH: AC 2000V FOR ONE MINUTE
 4. FUSE: Ø5X20mm
- C: APPROVALS:
 UL, CUL, VDE, ENEC, & CCC
- D: DIAGRAM:

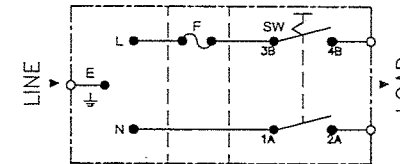

E: ORDERING INFORMATION:

P/N	PANEL THICKNESS	SWITCH'S TERMINAL
0717-1S-PQ08N-A	0.8 mm	
0717-1S-PQ10N-A	1.0 mm	
0717-1S-PQ12N-A	1.2 mm	
0717-1S-PQ14N-A	1.4 mm	

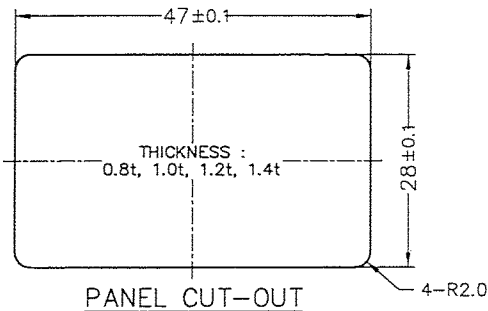
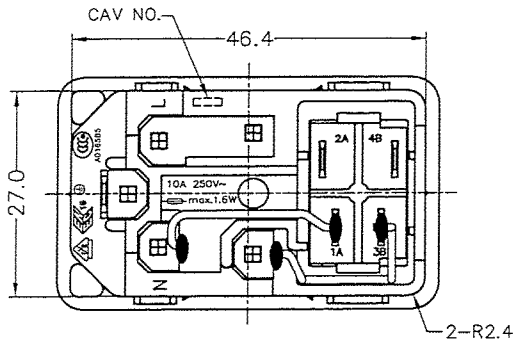
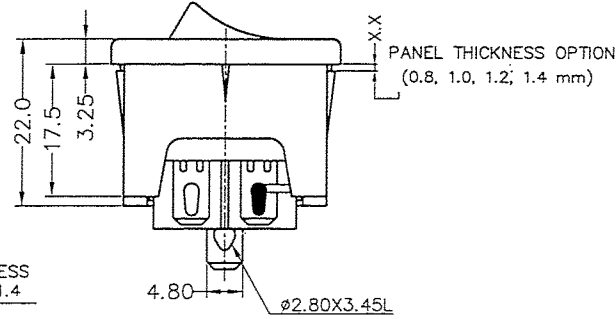
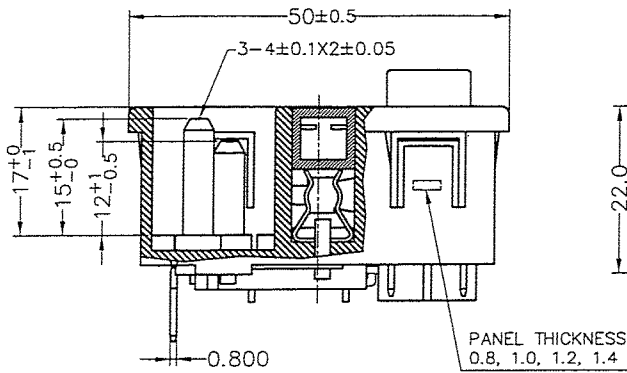
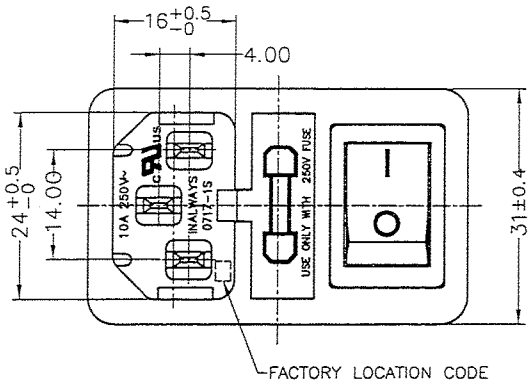

圖面管制中心

嚴禁 2013.6.07 複印

力瑋出圖章

發圖者: 李孟琦

REV	DATE	DOCUMENT	DESCRIPTION
J			
I			
H			
G	2012.11.27	DGR12027	CHANGE SAFETY MARK
F	2008.03.07	DGR08012	MARK CHANGE

力瑋實業股份有限公司
INALWAYS CORPORATION

TOLERANCE UNLESS OTHERWISE MARKED
 DIMENSION: ANGULAR: ±3°
 .000 : ±0.1
 .00 : ±0.2
 .0 : ±0.3

A 4 UNIT SCALE SHEET
 mm 1 : 1 1 of 1

PART NO.: 0717-1S-PQXXN-A		NAME: AC INLET 3P WITH SWITCH & FUSE HOLDER (SNAP-IN)	
MATERIAL: SEE ABOVE		SPEC.: IEC 60320-1, C14 IEC 60127-6	
APPROVED	CHECKED	DESIGNER	NOTE:
		天	
		2012-11-27	DOC.# S717-0027



AYVZZ.E122965 Attachment Plugs with Overload Protection - Component

[Page Bottom](#)

Attachment Plugs with Overload Protection - Component

[See General Information for Attachment Plugs with Overload Protection - Component](#)

INALWAYS CORP

E122965

7TH FL 105 WUGUNG RD
WUGU INDUSTRIAL DISTRICT
WUGU SHIANG
TAIPEI HSIEN, 24890 TAIWAN

Power inlets, Cat. Nos. 0713, 0717, 0717-1.

Cat Nos. 0725, 0725-1, 0726, 0726-1.

Appliance inlets, Cat. No. 0717-2 followed by P, C or F, followed by S, LS, Q or W, followed by two digits.

0717-1 Series: Models 0717-1-PS, 0717-1-PLS, 0717-1-PQ, 0717-1-PW may be followed by three alphanumeric digits; 0717-1S Series: Models 0717-1S-PS, 0717-1S-PLS, 0717-1S-PQ, 0717-1S-PW may be followed by three alphanumeric digits.

Appliance inlets with overcurrent protector, 0717-2S Series: Model 0717-2S followed by C or P, followed by Q or S.

Marking: Company name and catalog or model designation on device or carton.

[Last Updated](#) on 2008-06-18

[Questions?](#)

[Print this page](#)

[Notice of Disclaimer](#)

[Page Top](#)

[Copyright](#) ♦ [2011 Underwriters Laboratories Inc.®](#)

The appearance of a company's name or product in this database does not in itself assure that products so identified have been manufactured under UL's Follow-Up Service. Only those products bearing the UL Mark should be considered to be Listed and covered under UL's Follow-Up Service. Always look for the Mark on the product.

UL permits the reproduction of the material contained in the Online Certification Directory subject to the following conditions: 1. The Guide Information, Designs and/or Listings (files) must be presented in their entirety and in a non-misleading manner, without any manipulation of the data (or drawings). 2. The statement "Reprinted from the Online Certifications Directory with permission from Underwriters Laboratories Inc." must appear adjacent to the extracted material. In addition, the reprinted material must include a copyright notice in the following format: "Copyright © 2011 Underwriters Laboratories Inc.®"

An independent organization working for a safer world with integrity, precision and knowledge.



AYVZ8.E122965
Attachment Plugs with Overload Protection Certified for Canada - Component

[Page Bottom](#)

Attachment Plugs with Overload Protection Certified for Canada - Component

[See General Information for Attachment Plugs with Overload Protection Certified for Canada - Component](#)

INALWAYS CORP
7TH FL 105 WUGUNG RD
WUGU INDUSTRIAL DISTRICT
WUGU SHIANG
TAIPEI HSIEN, 24890 TAIWAN

E122965

Appliance Inlets, 0717-1 Series: Models 0717-1-PS, 0717-1-PLS, 0717-1-PQ, 0717-1-PW maybe followed by three alphanumeric digits; 0717-1S Series: Models 0717-1S-PS, 0717-1S-PLS, 0717-1S-PQ, 0717-1S-PW maybe followed by three alphanumeric digits.

Appliance inlets with overcurrent protector , 0717-2S Series: Model 0717-2S, followed by C or P, followed by Q or S.



Marking: Company name, model designation and Recognized Component Mark for Canada
[Last Updated](#) on 2008-02-08

[Questions?](#)

[Print this page](#)

[Notice of Disclaimer](#)

[Page Top](#)

[Copyright © 2011 Underwriters Laboratories Inc.®](#)

The appearance of a company's name or product in this database does not in itself assure that products so identified have been manufactured under UL's Follow-Up Service. Only those products bearing the UL Mark should be considered to be Listed and covered under UL's Follow-Up Service. Always look for the Mark on the product.

UL permits the reproduction of the material contained in the Online Certification Directory subject to the following conditions: 1. The Guide Information, Designs and/or Listings (files) must be presented in their entirety and in a non-misleading manner, without any manipulation of the data (or drawings). 2. The statement "Reprinted from the Online Certifications Directory with permission from Underwriters Laboratories Inc." must appear adjacent to the extracted material. In addition, the reprinted material must include a copyright notice in the following format: "Copyright © 2011 Underwriters Laboratories Inc.®"

An independent organization working for a safer world with integrity, precision and knowledge.



ZEICHENGENEHMIGUNG MARKS APPROVAL

Inalways Corporation
PO Box 17-196
24899 Sinjhuang, TAIPEI
TAIWAN

ist berechtigt, für ihr Produkt /
is authorized to use for their product

Gerätestecker mit integriertem Gerätesicherungshalter
Appliance inlet with integrated fuse-holder

die hier abgebildeten markenrechtlich geschützten Zeichen
für die ab Blatt 2 aufgeführten Typen zu benutzen /
the legally protected Marks as shown below for the types referred to on page 2 ff.



Geprüft und zertifiziert nach /
Tested and certified according to

DIN EN 60127-1 (VDE 0820-1):2007-02; EN 60127-1:2006
DIN EN 60320-1 (VDE 0625-1):2008-05; EN 60320-1:2001 + A1:2007
DIN EN 60127-6 (VDE 0820 Teil 6):2003-10; EN 60127-6:1994+ A1:1996+ A2:2003

VDE Prüf- und Zertifizierungsinstitut GmbH
Testing and Certification Institute
Zertifizierungsstelle / *Certification*

VDE Zertifikate sind nur gültig bei Veröffentlichung unter
VDE certificates are valid only when published on

Aktenzeichen: 1391600-1550-0018 / 103213

File ref.:

Ausweis-Nr. 40022412

Blatt 1

Certificate No.

Page

Weitere Bedingungen siehe Rückseite und Folgeblätter /
further conditions see overleaf and following pages

Offenbach, 2007-10-18

(letzte Änderung/updated 2009-02-26)

<http://www.vde.com/zertifikat>

<http://www.vde.com/certificate>

Name und Sitz des Genehmigungs-Inhabers / *Name and registered seat of the Certificate holder*
Inalways Corporation, PO Box 17-196, 24899 Sinjhuang, TAIPEI, TAIWAN

Aktenzeichen / *File ref.*

1391600-1550-0018 / 103213 / FG31 / E

letzte Änderung / *updated* Datum / *Date*
2009-02-26 2007-10-18

Dieses Blatt gilt nur in Verbindung mit Blatt 1 des Zeichengenehmigungsausweises Nr. 40022412.
This supplement is only valid in conjunction with page 1 of the Certificate No. 40022412.

Gerätestecker mit integriertem Gerätesicherungshalter
Appliance inlet with integrated fuse-holder

Typ(en) / *Type(s)*:

- 1 0717
- 2 0717-1
- 3 0717-1S

Bemessungsspannung AC 250 V
Rated voltage

Bemessungsstrom 10 A
Rated current

Bemessungswert der zul. Verlustleistung 1,6 W / 10 A
Rated power acceptance

Polzahl 2-polig mit Schutzkontakt
Number of poles 2-pole with earthing contact

Bauart Normblatt C14
Kind of construction standard sheet C14

Ausführung(en) mit Montagerahmen für Geräteschalter entsprechend EN 61058-1
Construction(s) with mounting frame for switches for appliances according to EN 61058
Für / for 3

Kategorie PC 2
Category

Stifttemperatur max. 70°C
Temperature of the pins

Fortsetzung siehe Blatt 3 /
continued on page 3



CERTIFICATE ENEC 2011059

Our ref. 264861-1

Product Appliance inlet

Rating and principal characteristics 10 A, 250 V~, IP20

Trade mark (if any) INALWAYS

Type 0717 series

Name and address of the licensee
Inalways Corporation
P. O. BOX 17-196
Sinjhuang 24899
Taipei County
TAIWAN

Address of the manufacturer
Inalways Electronic (Dongguang) Co. Ltd.
Si Huan Rd., Xianxi, Changan Dongguan City
GUANGDONG PROVINCE 523846
CHINA

Is in conformity with EN 60320-1:2001 + A1:2007

As shown in the Test Report(s) No(s) 264861-1

It is authorised to use of the marks ENEC 16

Validity This certificate is valid until 19 December 2016 unless the standard in question has been amended or superseded with significant changes in requirements, in which case, SGS Fimko has the right to shorten the validity of the certificate based on the legislation of the European Union. This certificate includes the right to use the ENEC 16 mark under the condition that changes (if any) will be checked at SGS Fimko before the product is brought onto market and that the conditions for ENEC certification are met.

Directive information The product(s) fulfils the essential safety requirements for CE conformity marking according to the Low Voltage Directive (2006/95/EC) at the date of issue of this certificate.

With the following limitations -

Date of issue 19 December 2011

Signature

Sixten Lökfors
Project Manager

This certificate has 1 appendix



This certificate is issued by the company under its General Conditions for Certification Services accessible at www.sgs.com/terms_and_conditions.htm. Attention is drawn to the limitations of liability defined therein and in the Test Report here above mentioned which findings are reflected in this certificate. Any unauthorized alteration, forgery or falsification of the content or appearance of this document is unlawful and offenders may be prosecuted to the fullest extent of the law.

Additional information

- Standard sheet C14 and C18
 - for class I or class II equipments
 - with or without fuse holder and opening for eg switch
 - with different soldering tabs and fixings

Product Code of 0717 series:

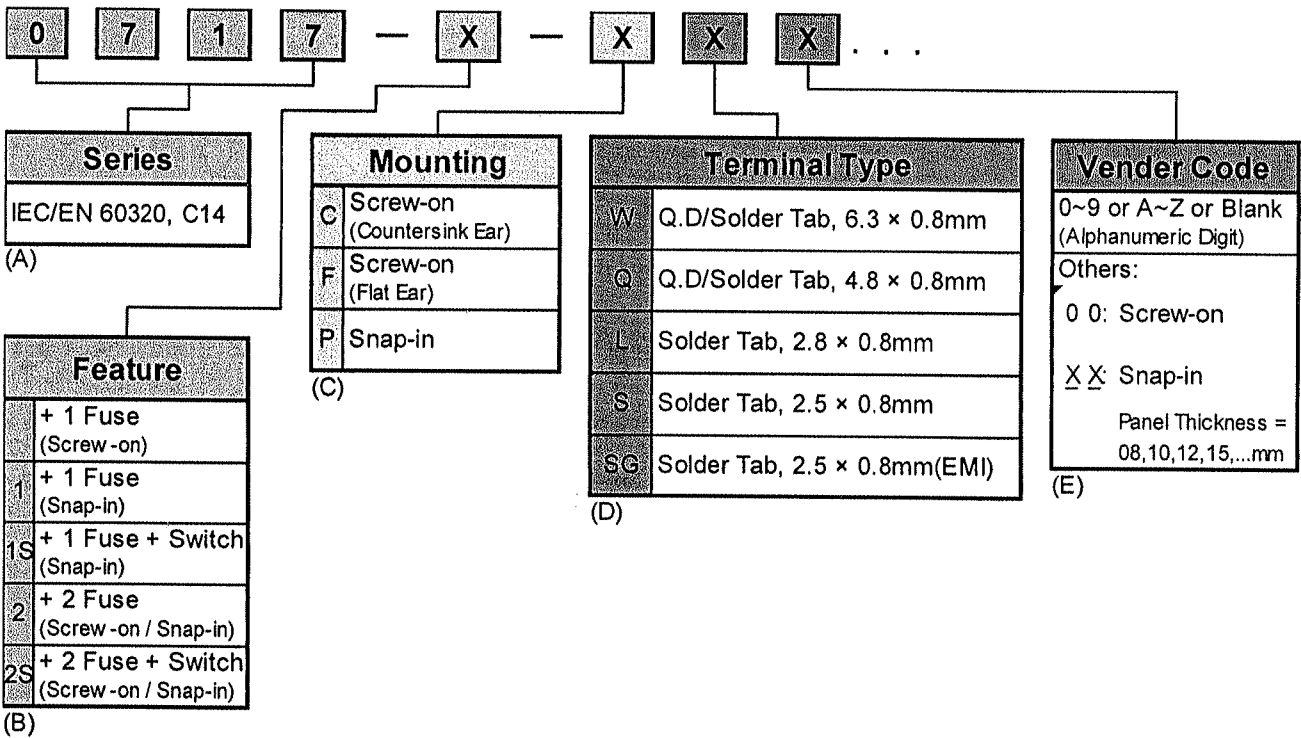

Manufacturing site(s)

Inalways Electronic (Dongguang) Co. Ltd.
 Si Huan Rd., Xianxi, Changan Dongguan City
 GUANGDONG PROVINCE 523846, CHINA



CERTIFICATE FOR CHINA COMPULSORY PRODUCT CERTIFICATION

No. : 2003010204074306

NAME AND ADDRESS OF THE APPLICANT

INALWAYS ELECTRONIC(DONGGUAN) CO., LTD.
Sihuan Road, Xianxi Village, Chang'an Town, Dongguan

NAME AND ADDRESS OF THE MANUFACTURER

INALWAYS ELECTRONIC(DONGGUAN) CO., LTD.
Sihuan Road, Xianxi Village, Chang'an Town, Dongguan

NAME AND ADDRESS OF THE FACTORY

INALWAYS ELECTRONIC(DONGGUAN) CO., LTD.
Sihuan Road, Xianxi Village, Chang'an Town, Dongguan

NAME, MODEL AND SPECIFICATION

10A 250V Appliance Inlet for Class I Equipment for Cold
Conditions;10A 250V Appliance Inlet for Class I Equipment for Cold
Conditions with FUSE-HOLDERS

0707-1、0707-2、0711、0711-1、0711-1RS、0711-1RS-PQ、0711-1RS-PS、0711-
1RS-PSG、0711-2、0711-SCQ、0711-SCS、0711-SPQ、0711-SPS、0714、0714-1、
0714-P 10A 250V~; 0717、0717-1、0717-1S、0717-2、0717-2S 10A 250V~

THE STANDARDS AND TECHNICAL REQUIREMENTS FOR THE PRODUCTS

GB17465.1-2009

This is to certify that the above mentioned products have met the
requirements of implementation rules for compulsory certification(REF
NO. CNCA-01C-006:2011).

Date of issue: Apr. 19, 2012 Date of expiry: Oct. 13, 2014

Validity of this certificate is subject to positive result of the regular
follow up inspection by issuing certification body until the expiry date.

Date of original certification: Aug. 04, 2003

This certificate can be verified through CNCA's website: www.cnca.gov.cn



President:

Wang Kejiao



CHINA QUALITY CERTIFICATION CENTRE

Section 9, No. 188, Nansihuan Xilu, Beijing 100070 P.R. China

<http://www.cqc.com.cn>

Q 0535462

 華瑋電子(東莞)有限公司 出貨檢驗規範							核准	審核	制作			
客戶名稱	RAPID		產品名稱	AC SOCKET		文件編號	郝哲菊	吳宗亮	宇路			
客戶料號	/		華瑋料號	0717-1S-PQ12N-A		文件版本						
抽樣標準	MIL-STD-105E單次正常II級抽樣		允收水準	CR = 0	MA = 0.1	MI = 0.25				客制編號		
檢驗項目	檢驗內容						缺點類別			檢驗方式 / 允收標準	判定	
							CR (嚴重)	MA (主要)	MI (次要)			
1. 紙箱外觀、料號、數量與箱麥確認	<input type="checkbox"/> 紙箱表面不可有壓垮、變形或破損、水漬、碰撞損壞							V		目視		
	<input type="checkbox"/> 出貨數量與出貨單數量須相符，箱麥標示需正確							V		目視 / 點數		
	<input type="checkbox"/> 出貨標籤之客戶料號、料號與送貨單資料及實物相符							V		目視		
2. 產品外觀檢測	<input type="checkbox"/> 主面外觀：射料不足、塑膠破損、髒污異色、毛邊、結合線、削傷、撞傷							V		目視		
	<input type="checkbox"/> 次表面外觀：射料不足、塑膠破損、髒污異色、毛邊、結合線、削傷、撞傷								V	目視		
	<input type="checkbox"/> 端子錯置 <input type="checkbox"/> 端子壓垮 <input type="checkbox"/> 端子漏植 <input type="checkbox"/> 端子未定位 <input type="checkbox"/> 端子晃動 <input type="checkbox"/> 端子漏加壓 <input type="checkbox"/> 卡鉤拉歪 <input type="checkbox"/> 卡鉤斷裂						V			目視		
	<input type="checkbox"/> 線材鉤焊端需完全包覆不可裸露或破損，松脫						V			目視		
	<input type="checkbox"/> 線材絕緣皮層不可破損，刮傷						V			目視		
	<input type="checkbox"/> 熱縮導管需熱縮到位							V		目視		
3. 尺寸檢驗(mm)	檢驗編號	尺寸規格	Cav#_	Cav#_	Cav#_	Cav#_	Cav#_	Cav#_	Cav#_	Cav#_	檢驗方式 / 允收標準	判定
	1	14.00±0.2									工程圖面	
	2	4.00±0.2									工程圖面	
	3	24+0.5/-0									工程圖面	
	4	16+0.5/-0									工程圖面	
	5	46.4±0.3									工程圖面	
	6	27.0±0.3									工程圖面	
	7	12+1/-0.5									工程圖面	
	8	15+0.5/-0									工程圖面	
											工程圖面	
											工程圖面	
											工程圖面	
											工程圖面	
4. 耐電壓&絕緣阻抗測試(依承認書測試條件)											高壓測試儀	
5. 扭力測試											<input type="checkbox"/> 扭力規格: 8kgf-cm <input type="checkbox"/> 特殊規格: _____ kgf-cm <input type="checkbox"/> N/A	
6. 拔出力測試											<input type="checkbox"/> SHEET F(10A): 全PIN最大50N，單PIN最小1.5N <input type="checkbox"/> SHEET J(16A): 全PIN最大60N，單PIN最小2N <input type="checkbox"/> N/A	
7. 膜厚測試	<input type="checkbox"/> 測試 <input type="checkbox"/> N/A										<input type="checkbox"/> 電鍍規格: 打銅底2.5um以上，鍍錫3.0um以上 <input type="checkbox"/> 電鍍規格: 打銅底2.5um以上，鍍錫3.0um以上 <input type="checkbox"/> 電鍍規格: 打銅底2.5um以上，鍍霧錫3.0um以上	
8. 刻字檢驗(Rating、料號、極性接地標示、INALWAYS Logo、認證安規標志、模具編號...).											目視	
9. 其它: _____												

Product Specification

T8550VBAAA



Description

Double pole, ON OFF, Rocker switch

1 of 2

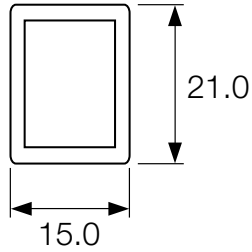

Bezel

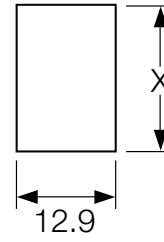

Panel thickness	Dimension X
0.75 - 1.24	26.1/26.2
1.25 - 1.99	26.3/26.4
2.00 - 3.00	26.7/26.8

Cut-Out

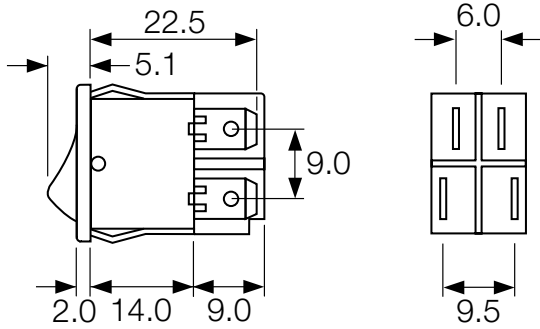

Side profile

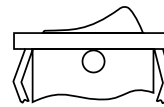

Rocker profile

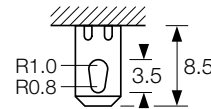

Solder

Terminal style

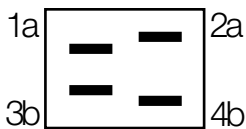

Terminal Identification

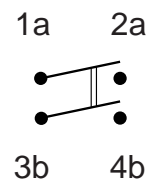

Circuit Identification

Product Specification**T8550VBAAA****Arcolectric**

Description

Double pole, ON OFF, Rocker switch

2 of 2

MATERIALS

Component	Material	Colour	Marking	Flammability Rating
Body	Nylon	Black	See below	UL94-V2
Rocker	Nylon	Black	See below	UL94-V2
Terminals	Copper Alloy			
Contacts	Silver Alloy			

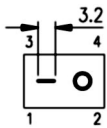
ROCKER MARKING

Printed in white

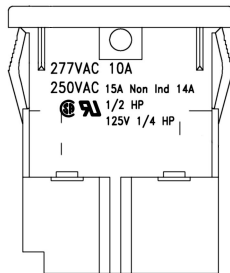

BODY MARKING

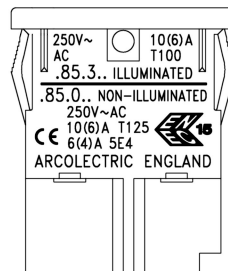
Side A



Side B

APPROVALS/RATINGS

Approval Body	Specification	Certificate No.	Rating
	EN61058-1	137198	10(6)A, 250V ac T125 6(4)A, 250V ac T125, 5E4 (50,000 operations)
	UL 1054	E45221	15A Non Ind 250V ac 14A Ind 250V ac 10A 277V ac 1/2HP 250V ac 1/4HP 125v ac
	Compliant		



Certificate of Compliance

Certificate Number: LR 10990-39

Revision: LR 10990-55

Issued to: **ARCOLECTRIC SWITCHES PLC**
Central Avenue
East Molesey
Surrey, England
KT8 2RF

SUBMITTOR

Date Issued: May 4, 1998

The products listed below are eligible to bear the CSA Mark

Issued by: G. Raymond, Eng.
Montréal, QC Canada

Signature: _____

PRODUCTS

CLASS 6241 10 - SWITCHES - Snap - Special Use

Rocker switches, single or double pole, Series 8500, 8550, 14A, 250V ac; 15A, 250V ac resistive; 10A, 277V ac; 1/2 hp, 250V ac, 1/4 hp, 125V ac.

Note: Model designations may have prefix and suffix letters.

APPLICABLE STANDARDS

CSA Std C22.2 No. 55-M1986 - Special Use Switches



Product Certification History

Revision	Date	Description
LR 10990-39	October 2, 1991	Rocker switches Series 8500
LR 10990-55	May 4, 1998	Rerating

ENEC CERTIFICATE

Switches for appliances (EN 61058-1)

Product:	Switches for appliances
Manufacturer:	Arcoelectric Switches plc, 61 Central Avenue, West Molesey, Surrey, England KT8 2RF
Production site:	See the appendix
Certificate holder:	Arcoelectric Switches plc, 61 Central Avenue, West Molesey, Surrey, England KT8 2RF
Certified by request of:	Arcoelectric Switches plc, 61 Central Avenue, West Molesey, Surrey, England KT8 2RF
Trademark:	ARCOELECTRIC
Model/Type ref.:	8500 Series
Rated current or power:	6(4) A, 10(6) A
Rated voltage:	250 Va.c.
Pattern number:	1 or 2
Rated ambient temperature:	125 °C or 100 °C
Switch Category	D
Proof tracking index (PTI)	250 V
Insulation Class:	For class II appliances
Degree of protection:	IP40
Additional information:	full disconnection; for dirty pollution situations

Variants covered by this Certificate are specified in the attached appendix.

A sample of the product has been tested and found in conformity with EN 61058-1:1992 + A1:1993, as shown in the Test Report with ref. No. 99-04251 and 99-04251/A1.

Products included in this Certificate are allowed to carry the marks ENEC 15, UL International Demko A/S - as shown in annex 1.

This Certificate is only valid for products, which are identical to the certified product, and manufactured at the above mentioned production site(s). UL International Demko A/S has to be informed in writing about any changes, in accordance with the "UL International Demko A/S Standard Terms and Conditions" for UL International Demko A/S services. This document contains Error! Unknown switch argument. page(s).

Herlev, 2003-07-08

Karina Christiansen
 Certification Manager

UL International Demko A/S

Lyskaer 8, P.O. Box 514
 DK-2730 Herlev, Denmark
 Telephone: +45 44856565
 Fax: +45 44856500



An Affiliate of
**Underwriters
 Laboratories Inc.®**

APPENDIX TO ENEC CERTIFICATE N° 122551-03/A1

Production sites:

1. Arcoelectric Switches plc,
61 Central Avenue, West Molesey, Surrey, KT8 2RF United Kingdom
2. Arcoelectric Switches Mfg Plant,
Hua Mei Rd, Heng Gang Town, Huang Ge Keng,
Long Gang District, Shenzhen Guangdong, P.R. China
3. Arcoelectric Tunisie,
23 Rue 62128, Zone Industrielle Ibn Khaldoun, Cite Ettahrir, 2042 Tunis

Herlev, 2003-07-08

Karina Christiansen
Certification Manager

UL International Demko A/S

Lyskaer 8, P.O. Box 514
DK-2730 Herlev, Denmark
Telephone: +45 44856565
Fax: +45 44856500



An Affiliate of
**Underwriters
Laboratories Inc.®**

APPENDIX TO ENEC CERTIFICATE N° 122551-03/A1

The Certificate covers the following:

8500 Series Type key

	Body Reference Any letter A -Z 'B' 19.1/19.8 x 13.0 mm 'O' 12.7 mm dia hole
	Actuator Reference Any letter A -Z 'V' Curved 'D' Paddle 'P' Push Button 'R' Semi rotary actuator
	Type Reference 8500 - Single Pole ON/OFF 6(4)A 250V 5E4 T125 - 10(6)A 250V 1E4 T125 8503 - Single Pole ON/OFF illuminated 6(4)A 250V 5E4 T125 - 10(6)A 250V 1E4 T100 8550 - Double Pole ON/OFF 6(4)A 250V 5E4 T125 - 10(6)A 250V 1E4 T125 8553 - Double Pole ON/OFF illuminated 6(4)A 250V 5E4 T125 - 10(6)A 250V 1E4 T100
	Terminal Reference Any letter A -Z 'H' - 4.8 x 0.8 mm tab 'T' - Solder tag 'K' - Alternative solder tag 'R' - Short solder tag

EMC requirements are not applicable for this product.

This Certificate replaces the Certificate with No. 122551-03, dated 2001-03-29, due to adding production sites.

Herlev, 2003-07-08

Karina Christiansen
Certification Manager

UL International Demko A/S

Lyskaer 8, P.O. Box 514
DK-2730 Herlev, Denmark
Telephone: +45 44856565
Fax: +45 44856500



An Affiliate of
**Underwriters
Laboratories Inc.®**

**Annex 1 to Certificate, licence No.
DK 122551-03**

Annex of the Form of the Mark.

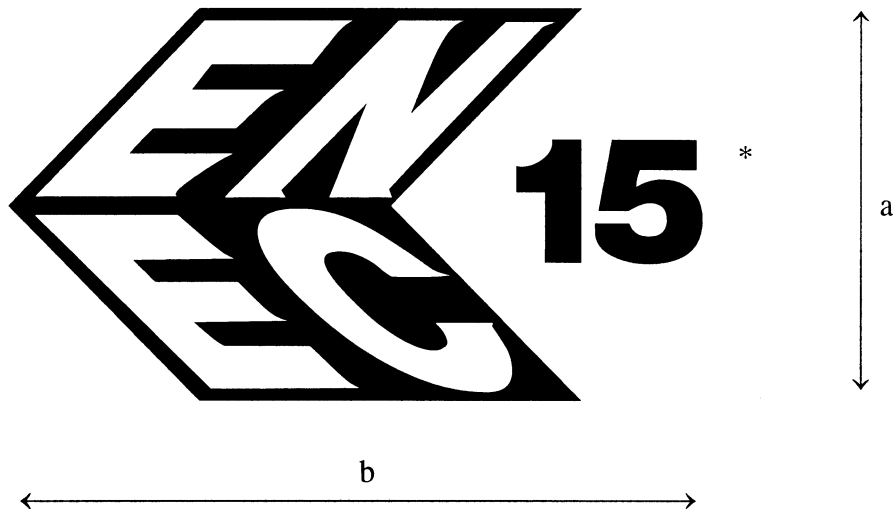

* Identification number of the Certification Body

Size of the Mark:

The size of the mark may be reduced on the condition that it remains legible and that the ratio $b/a = 1,7$ is kept.

UL International Demko A/S

Lyskaer 8, P.O. Box 514
DK-2730, Herlev, Denmark
Telephone: +45 44856565
Fax: +45 44856500



A Subsidiary of
**Underwriters
Laboratories Inc.**



Certificate of Compliance

File Number: E45221
Section: 6

Issued to: Arcoelectric Switches
Central Avenue,
Molesey,
Surrey, England. KT8 2RF

The products listed below are eligible to bear the UL Mark

Issued by: Stephen Italo
Melville, New York.

Signature:

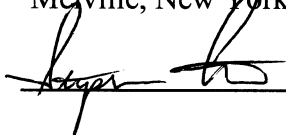

Products: Special Use Switches

Cat. Nos. 85 f/b 00, 03, 50, 53 aa

Rating: 14 A, 250 Vac
½ Hp, 250 Vac
¼ Hp, 125 Vac
15 A, 250 Vac "Res"
10 A, 277 Vac

Temperature: 105°C

Applicable Standards: UL 1054, SPECIAL-USE SWITCHES

UL Recognized Component Mark  on the switch or smallest shipping container. When the on Mark is not on the switch, the company name and catalog number appear with the Mark on the container.