

**IMPORTANT:
Read Before Using**

**IMPORTANT :
Lire avant usage**

**IMPORTANTE:
Leer antes de usar**



**Operating/Safety Instructions
Consignes de fonctionnement/sécurité
Instrucciones de funcionamiento y seguridad**

8220

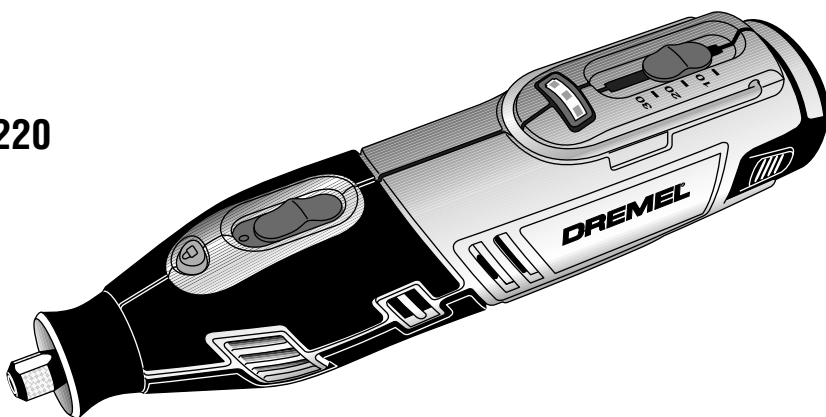

DREMEL®

P.O. Box 081126 Racine, WI 53408-1126

**Call Toll Free for
Consumer Information
& Service Locations**

**Pour obtenir des informations
et les adresses de nos centres
de service après-vente,
appelez ce numéro gratuit**

**Llame gratis para
obtener información
para el consumidor y
ubicaciones de servicio**

1-800-4-DREMEL (1-800-437-3635) www.dremel.com





**For English Version
See page 2**

**Version française
Voir page 31**

**Versión en español
Ver la página 61**

Safety Symbols

The definitions below describe the level of severity for each signal word. Please read the manual and pay attention to these symbols.

	This is the safety alert symbol. It is used to alert you to potential personal injury hazards. Obey all safety messages that follow this symbol to avoid possible injury or death.
	DANGER indicates a hazardous situation which, if not avoided, will result in death or serious injury.
	WARNING indicates a hazardous situation which, if not avoided, could result in death or serious injury.
	CAUTION, used with the safety alert symbol, indicates a hazardous situation which, if not avoided, will result in minor or moderate injury.

General Power Tool Safety Warnings

 **Read all safety warnings and all instructions.** Failure to follow the warnings and instructions may result in electric shock, fire and/or serious injury.

SAVE ALL WARNINGS AND INSTRUCTIONS FOR FUTURE REFERENCE

The term “power tool” in the warnings refers to your mains-operated (corded) power tool or battery-operated (cordless) power tool.

Work area safety

Keep work area clean and well lit. Cluttered or dark areas invite accidents.

Do not operate power tools in explosive atmospheres, such as in the presence of flammable liquids, gases or dust. Power tools create sparks which may ignite the dust or fumes.

Keep children and bystanders away while operating a power tool. Distractions can cause you to lose control.

Electrical safety

Power tool plugs must match the outlet. Never modify the plug in any way. Do not use any adapter plugs with earthed (grounded) power tools. Unmodified plugs and matching outlets will reduce risk of electric shock.

Avoid body contact with earthed or grounded surfaces such as pipes, radiators, ranges and refrigerators. There is an increased risk

of electric shock if your body is earthed or grounded.

Do not expose power tools to rain or wet conditions. Water entering a power tool will increase the risk of electric shock.

Do not abuse the cord. Never use the cord for carrying, pulling or unplugging the power tool. Keep cord away from heat, oil, sharp edges or moving parts. Damaged or entangled cords increase the risk of electric shock.

When operating a power tool outdoors, use an extension cord suitable for outdoor use. Use of a cord suitable for outdoor use reduces the risk of electric shock.

If operating the power tool in damp locations is unavoidable, use a Ground Fault Circuit Interrupter (GFCI) protected supply. Use of an GFCI reduces the risk of electric shock.

Personal safety

Stay alert, watch what you are doing and use common sense when operating a

power tool. Do not use a power tool while you are tired or under the influence of drugs, alcohol or medication. A moment of inattention while operating power tools may result in serious personal injury.

Use personal protective equipment. Always wear eye protection. Protective equipment such as dust mask, non-skid safety shoes, hard hat, or hearing protection used for appropriate conditions will reduce personal injuries.

Prevent unintentional starting. Ensure the switch is in the off-position before connecting to power source and / or battery pack, picking up or carrying the tool. Carrying power tools with your finger on the switch or energizing power tools that have the switch on invites accidents.

Remove any adjusting key or wrench before turning the power tool on. A wrench or a key left attached to a rotating part of the power tool may result in personal injury.

Do not overreach. Keep proper footing and balance at all times. This enables better control of the power tool in unexpected situations.

Dress properly. Do not wear loose clothing or jewelry. Keep your hair, clothing and gloves away from moving parts. Loose clothes, jewelry or long hair can be caught in moving parts.

If devices are provided for the connection of dust extraction and collection facilities, ensure these are connected and properly used. Use of dust collection can reduce dust-related hazards.

Power tool use and care

Do not force the power tool. Use the correct power tool for your application. The correct power tool will do the job better and safer at the rate for which it was designed.

Do not use the power tool if the switch does not turn it on and off. Any power tool that cannot be controlled with the switch is dangerous and must be repaired.

Disconnect the plug from the power source and/or the battery pack from the power tool before making any adjustments, changing accessories, or storing power tools. Such preventive safety measures reduce the risk of starting the power tool accidentally.

Store idle power tools out of the reach of children and do not allow persons unfamiliar with the power tool or these instructions to operate the power tool. Power tools are dangerous in the hands of untrained users.

Maintain power tools. Check for misalignment or binding of moving parts, breakage of parts and any other condition that may affect the power tool's operation. If damaged, have the power tool repaired before use.

Many accidents are caused by poorly maintained power tools.

Keep cutting tools sharp and clean. Properly maintained cutting tools with sharp cutting edges are less likely to bind and are easier to control.

Use the power tool, accessories and tool bits etc. in accordance with these instructions, taking into account the working conditions and the work to be performed. Use of the power tool for operations different from those intended could result in a hazardous situation.

Battery tool use and care

Recharge only with the charger specified by the manufacturer. A charger that is suitable for one type of battery pack may create a risk of fire when used with another battery pack.

Use power tools only with specifically designated battery packs. Use of any other battery packs may create a risk of injury and fire.

When battery pack is not in use, keep it away from other metal objects like paper clips, coins, keys, nails, screws, or other small metal objects that can make a connection from one terminal to another. Shorting the battery terminals together may cause burns or a fire.

Under abusive conditions, liquid may be ejected from the battery, avoid contact. If contact accidentally occurs, flush with water. If liquid contacts eyes, additionally seek medical help. Liquid ejected from the battery may cause irritation or burns.

Service

Have your power tool serviced by a qualified repair person using only identical replacement parts. This will ensure that the safety of the power tool is maintained.

Safety Rules for Rotary Tools

Safety warnings common for grinding, sanding, wire brushing, polishing, carving or abrasive cutting-off operations:

This power tool is intended to function as a grinder, sander, wire brush, polisher, carving or cut-off tool. Read all safety warnings, instructions, illustrations and specifications provided with this power tool. Failure to follow all instructions listed below may result in electric shock, fire and/or serious injury.

Do not use accessories which are not specifically designed and recommended by the tool manufacturer. Just because the accessory can be attached to your power tool, it does not assure safe operation.

The RATED SPEED of the accessories must be at least equal to the operating speed setting marked on the power tool. Accessories running faster than their RATED SPEED can break and fly apart.

The outside diameter and the thickness of your accessory must be within the capacity rating of your power tool. Incorrectly sized accessories cannot be adequately controlled.

The arbor size of wheels, sanding drums or any other accessory must properly fit the spindle or collet of the power tool. Accessories that do not match the mounting hardware of the power tool will run out of balance, vibrate excessively and may cause loss of control.

Mandrel mounted wheels, sanding drums, cutters or other accessories must be fully inserted into the collet or chuck. If the mandrel is insufficiently held and/or the overhang of the wheel is too long, the mounted wheel may become loose and be ejected at high velocity.

Do not use a damaged accessory. Before each use inspect the accessory such as abrasive wheels for chips and cracks, sanding drum for cracks, tear or excess wear, wire brush for loose or cracked wires. If power tool or accessory is dropped, inspect for damage or install an undamaged accessory. After inspecting and installing an accessory, position yourself and bystanders away from the plane of the rotating accessory and run the power tool at maximum no-load speed for one minute. Damaged accessories will normally break apart during this test time.

Wear personal protective equipment. Depending on application, use face shield, safety goggles or safety glasses. As appropriate, wear dust mask, hearing protectors, gloves and workshop apron capable of stopping small abrasive or workpiece fragments. The eye protection must be capable of stopping flying debris generated by various operations. The dust mask or respirator must be capable of filtering particles generated by your operation. Prolonged exposure to high intensity noise may cause hearing loss.

Keep bystanders a safe distance away from work area. Anyone entering the work area must wear personal protective equipment. Fragments of workpiece or of a broken accessory may fly away and cause injury beyond immediate area of operation.

Hold power tool by insulated gripping surfaces only, when performing an operation where the cutting accessory may contact hidden wiring. Cutting accessory contacting a "live" wire may make exposed metal parts of the power tool "live" and could give the operator an electric shock.

Always hold the tool firmly in your hand(s) during the start-up. The reaction torque of the motor, as it accelerates to full speed, can cause the tool to twist.

Use clamps to support workpiece whenever practical. Never hold a small workpiece in one hand and the tool in the other hand while in use. Clamping a small workpiece allows you to use your hand(s) to control the tool. Round material such as dowel rods, pipes or tubing have a tendency to roll while being cut, and may cause the bit to bind or jump toward you.

Position the cord clear of the spinning accessory. If you lose control, the cord may be cut or snagged and your hand or arm may be pulled into the spinning accessory.

Never lay the power tool down until the accessory has come to a complete stop. The spinning accessory may grab the surface and pull the power tool out of your control.

After changing the bits or making any adjustments, make sure the collet nut, chuck or any other adjustment devices are securely tightened. Loose adjustment devices can unexpectedly shift, causing loss of control, loose rotating components will be violently thrown.

Safety Rules for Rotary Tools - (cont.)

Do not run the power tool while carrying it at your side. Accidental contact with the spinning accessory could snag your clothing, pulling the accessory into your body.

Regularly clean the power tool's air vents. The motor's fan will draw the dust inside the housing and excessive accumulation of powdered metal may cause electrical hazards.

Do not operate the power tool near flammable materials. Sparks could ignite these materials.

Do not use accessories that require liquid coolants. Using water or other liquid coolants may result in electrocution or shock.

Use only in well-ventilated area. Working in a safe environment reduces risk of injury.

Allow for sufficient space, at least 6", between your hand and the spinning bit. Do not reach in the area of the spinning bit. The proximity of the spinning bit to your hand may not always be obvious.

Do not touch the bit or collet after use. After use the bit and collet are too hot to be touched by bare hands.

Do not alter or misuse tool. Any alteration or modification is a misuse and may result in serious personal injury.

This product is not intended for use as a dental drill, in human or veterinary medical applications. Serious injury may result.

Kickback and Related Warnings

Kickback is a sudden reaction to a pinched or snagged rotating wheel, backing pad, brush or any other accessory. Pinching or snagging causes rapid stalling of the rotating accessory which in turn causes the uncontrolled power tool to be forced in the direction opposite of the accessory's rotation.

For example, if an abrasive wheel is snagged or pinched by the workpiece, the edge of the wheel that is entering into the pinch point can dig into the surface of the material causing the wheel to climb out or kickout. The wheel may either jump toward or away from the operator, depending on direction of the wheel's movement at the point of pinching. Abrasive wheels may also break under these conditions.

Kickback is the result of power tool misuse and/or incorrect operating procedures or conditions and can be avoided by taking proper precautions as given below.

Maintain a firm grip on the power tool and position your body and arm to allow you to

resist kickback forces. The operator can control kickback forces, if proper precautions are taken.

Use special care when working corners, sharp edges etc. Avoid bouncing and snagging the accessory. Corners, sharp edges or bouncing have a tendency to snag the rotating accessory and cause loss of control or kickback.

Do not attach a toothed saw blade. Such blades create frequent kickback and loss of control.

Always feed the bit into the material in the same direction as the cutting edge is exiting from the material (which is the same direction as the chips are thrown). Feeding the tool in the wrong direction causes the cutting edge of the bit to climb out of the work and pull the tool in the direction of this feed.

When using rotary files, cut-off wheels, high-speed cutters or tungsten carbide cutters, always have the work securely clamped. These wheels will grab if they become slightly canted in the groove, and can kickback. When a cut-off wheel grabs, the wheel itself usually breaks. When a rotary file, high-speed cutter or tungsten carbide cutter grabs, it may jump from the groove and you could lose control of the tool.

Safety warnings specific for grinding and abrasive cutting-off operations:

Use only wheel types that are recommended for your power tool and only for recommended applications. For example: do not grind with the side of a cut-off wheel. Abrasive cut-off wheels are intended for peripheral grinding, side forces applied to these wheels may cause them to shatter.

For threaded abrasive cones and plugs use only undamaged wheel mandrels with an unrelieved shoulder flange that are of correct size and length. Proper mandrels will reduce the possibility of breakage.

Do not "jam" a cut-off wheel or apply excessive pressure. Do not attempt to make an excessive depth of cut. Overstressing the wheel increases the loading and susceptibility to twisting or snagging of the wheel in the cut and the possibility of kickback or wheel breakage.

Do not position your hand in line with and behind the rotating wheel. When the wheel, at the point of operation, is moving away from

Safety Rules for Rotary Tools - (cont.)

your hand, the possible kickback may propel the spinning wheel and the power tool directly at you.

When wheel is pinched, snagged or when interrupting a cut for any reason, switch off the power tool and hold the power tool motionless until the wheel comes to a complete stop. Never attempt to remove the cut-off wheel from the cut while the wheel is in motion otherwise kickback may occur. Investigate and take corrective action to eliminate the cause of wheel pinching or snagging.

Do not restart the cutting operation in the workpiece. Let the wheel reach full speed and carefully re-enter the cut. The wheel may bind, walk up or kickback if the power tool is restarted in the workpiece.

Support panels or any oversized workpiece to minimize the risk of wheel pinching and kickback. Large workpieces tend to sag under their own weight. Supports must be placed under the workpiece near the line of cut and near the edge of the workpiece on both sides of the wheel.

Use extra caution when making a "pocket cut" into existing walls or other blind areas.

The protruding wheel may cut gas or water pipes, electrical wiring or objects that can cause kickback.

Safety warnings specific for wire brushing operations:

Be aware that wire bristles are thrown by the brush even during ordinary operation. Do not overstress the wires by applying excessive load to the brush. The wire bristles can easily penetrate light clothing and/or skin.

Allow brushes to run at operating speed for at least one minute before using them. During this time no one is to stand in front or in line with the brush. Loose bristles or wires will be discharged during the run-in time.

Direct the discharge of the spinning wire brush away from you. Small particles and tiny wire fragments may be discharged at high velocity during the use of these brushes and may become imbedded in your skin.

Additional Safety Warnings

GFCI and personal protection devices like electrician's rubber gloves and footwear will further enhance your personal safety.

Do not use AC only rated tools with a DC power supply. While the tool may appear to work, the electrical components of the AC rated tool are likely to fail and create a hazard to the operator.

Keep handles dry, clean and free from oil and grease. Slippery hands cannot safely control the power tool.

Develop a periodic maintenance schedule for your tool. When cleaning a tool be careful not to disassemble any portion of the tool since internal wires may be misplaced or pinched or safety guard return springs may be improperly mounted. Certain cleaning agents such as gasoline, carbon tetrachloride, ammonia, etc. may damage plastic parts.

Ensure the switch is in the off position before inserting battery pack. Inserting the battery pack into power tools that have the switch on invites accidents.

⚠ WARNING Some dust created by power sanding, sawing, grinding, drilling, and other construction activities contains chemicals known to cause cancer, birth defects or other reproductive harm. Some examples of these chemicals are:

- Lead from lead-based paints,
- Crystalline silica from bricks and cement and other masonry products, and
- Arsenic and chromium from chemically-treated lumber.

Your risk from these exposures varies, depending on how often you do this type of work. To reduce your exposure to these chemicals: work in a well ventilated area, and work with approved safety equipment, such as those dust masks that are specially designed to filter out microscopic particles.



WARNING Read and understand all instructions. Failure to follow all instructions listed below, may result in electric shock, fire and/or serious personal injury.

IMPORTANT SAFETY AND OPERATING INSTRUCTIONS SAVE THESE INSTRUCTIONS

Charger Safety Rules

- 1. This manual contains instructions for battery charger model 876.** Do not substitute any other charger.
- 2. Before using battery charger, read all instructions and cautionary markings on (1) battery charger, (2) battery pack, and (3) product using battery.**
- 3. Charge only Dremel rechargeable batteries listed on page 11.** Other types of batteries may burst causing personal injury and damage.
- 4. Charge battery pack in temperatures above +32 degrees F (0 degrees C) and below +113 degrees F (45 degrees C). Store tool and battery pack in locations where temperatures will not exceed 120 degrees F (49 degrees C).** This is important to prevent serious damage to the battery cells.
- 5. Do not recharge battery in damp or wet environment. Do not expose charger to rain or snow.** Water entering battery charger may result in electric shock or fire.
- 6. Battery leakage may occur under extreme usage or temperature conditions. Avoid contact with skin and eyes.** The battery liquid is caustic and could cause chemical burns to tissues. If liquid comes in contact with skin, wash quickly with soap and water. If the liquid contacts your eyes, flush them with water for a minimum of 10 minutes and seek medical attention.
- 7. Place charger on flat nonflammable surfaces and away from flammable materials when recharging battery pack.** Carpeting and other heat insulating surfaces block proper air circulation which may cause overheating of the charger and battery pack. If smoke or melting of the charger or battery pack is observed, unplug the charger immediately and do not use the battery pack or charger. Contact customer service immediately.
- 8. Make sure cord is located so that it will not be stepped on, tripped over, or otherwise subjected to damage or stress.** Damaged plug and cord may result in electric shock or fire.
- 9. Disconnect the charger by pulling the plug rather than the cord. Do not operate charger with damaged cord or plug; have them replaced immediately.** Damaged plug or cord may result in electric shock or fire.
- 10. Do not insert battery pack in charger if battery pack case is cracked.** Using damaged battery pack may result in electric shock or fire.
- 11. Do not disassemble charger or operate the charger if it has received a sharp blow, been dropped or otherwise damaged in anyway.** Incorrect reassembly or damage may result in electric shock or fire.
- 12. Before each use, check the battery charger, cable and plug. If damage is detected, do not use the battery charger. Never open the battery charger yourself, take it to a Dremel Factory Service Center, or qualified serviceman only using original spare parts.** Incorrect reassembly may result in electric shock or fire.
- 13. Do not use attachments not recommended or sold by Dremel.** Using attachments not recommended may result in electric shock or fire.
- 14. Do not store battery pack in charger.** Battery pack stored in charger over a long period of time could lead to battery pack damage and fire.
- 15. Unplug charger from outlet before storage, attempting any maintenance or cleaning.** Such preventive safety measures reduce the risk of electric shock or fire.
- 16. Keep the battery charger clean by blowing compressed air on charger vents and wiping the charger housing with a damp cloth.** Contamination may result in electric shock or fire.
- 17. Replace battery pack if a substantial drop in operating time per charge is observed.** Battery pack may be nearing the end of its life.

FCC Caution:

The manufacturer is not responsible for radio interference caused by unauthorized modifications to this equipment. Such modifications could void the user's authority to operate the equipment.

This device complies with Part 15 of the FCC Rules. Operation is subject to the following two conditions:

- 1) This device may not cause harmful interference, and
- 2) This device must accept any interference received, including interference that may cause undesired operation.

NOTE! This equipment has been tested and found to comply with the limits for a Class B digital devices, pursuant to Part 15 of the FCC rules. These limits are designed to provide reasonable protection against harmful interference in a residential installation. This equipment generates uses and can radiate

radio frequency energy and, if not installed and used in accordance with the instructions, may cause harmful interference to radio communications. However, there is no guarantee that interference will not occur in a particular installation. If this equipment does cause harmful interference to radio or television reception, which can be determined by turning the equipment off and on, the user is encouraged to try to correct the interference by one or more of the following measures:

- Reorient or relocate the receiving antenna.
- Increase the separation between the equipment and receiver.
- Connect the equipment into an outlet on a circuit different from that to which the receiver is connected.
- Consult the dealer or an experienced radio/TV technician for help.

Battery Care

⚠ WARNING When batteries are not in tool or charger, keep them away from metal objects. For example, to protect terminals from shorting, **DO NOT** place batteries in a tool box or

pocket with nails, screws, keys, etc. Fire or injury may result.

DO NOT PUT BATTERIES INTO FIRE OR EXPOSE TO HIGH HEAT. They may explode.

Battery Disposal

⚠ WARNING Do not attempt to disassemble the battery or remove any component projecting from the battery terminals. Fire or injury may result. Prior to disposal, protect exposed terminals with heavy insulating tape to prevent shorting.

LITHIUM-ION BATTERIES

If equipped with a lithium-ion battery, the battery must be collected, recycled or disposed of in an environmentally sound manner.









"The EPA certified RBRC Battery Recycling Seal on the lithium-ion (Li-ion) battery indicates Robert Bosch Tool Corporation is voluntarily participating in an industry

program to collect and recycle these batteries at the end of their useful life, when taken out of service in the United States or Canada. The RBRC program provides a convenient alternative to placing used Li-ion batteries into the trash or the municipal waste stream, which may be illegal in your area.

Please call 1-800-8-BATTERY for information on Li-ion battery recycling and disposal bans/restrictions in your area, or return your batteries to a Bosch/Dremel Service Center for recycling. Robert Bosch Tool Corporation's involvement in this program is part of our commitment to preserving our environment and conserving our natural resources."

Symbols

IMPORTANT: Some of the following symbols may be used on your tool. Please study them and learn their meaning. Proper interpretation of these symbols will allow you to operate the tool better and safer.

Symbol	Designation / Explanation
V	Volts (voltage)
A	Amperes (current)
Hz	Hertz (frequency, cycles per second)
W	Watt (power)
kg	Kilograms (weight)
min	Minutes (time)
s	Seconds (time)
∅	Diameter (size of drill bits, grinding wheels, etc.)
n_0	No load speed (rotational speed at no load)
n	Rated speed (maximum attainable speed)
.../min	Revolutions or reciprocation per minute (revolutions, strokes, surface speed, orbits etc. per minute)
0	Off position (zero speed, zero torque...)
1, 2, 3, ... I, II, III,	Selector settings (speed, torque or position settings. Higher number means greater speed)
0 	Infinitely variable selector with off (speed is increasing from 0 setting)
	Arrow (action in the direction of arrow)
	Alternating current (type or a characteristic of current)
	Direct current (type or a characteristic of current)
	Alternating or direct current (type or a characteristic of current)
	Class II construction (designates double insulated construction tools)
	Earthing terminal (grounding terminal)

Symbols (continued)

IMPORTANT: Some of the following symbols may be used on your tool. Please study them and learn their meaning. Proper interpretation of these symbols will allow you to operate the tool better and safer.

Symbol	Designation / Explanation
	Designates Li-ion battery recycling program
	Designates Ni-Cad battery recycling program
	Alerts user to read manual
	Alerts user to wear eye protection
	This symbol designates that this tool is listed by Underwriters Laboratories.
	This symbol designates that this component is recognized by Underwriters Laboratories.
	This symbol designates that this tool is listed by Underwriters Laboratories, to United States and Canadian Standards.
	This symbol designates that this tool is listed by the Canadian Standards Association.
	This symbol designates that this tool is listed by the Canadian Standards Association, to United States and Canadian Standards.
	This symbol designates that this tool is listed by the Intertek Testing Services, to United States and Canadian Standards.
	This symbol designates that this tool complies to NOM Mexican Standards.

Functional Description and Specifications

WARNING Disconnect battery pack from tool before making any assembly, adjustments or changing accessories. Such preventive safety measures reduce the risk of starting the tool accidentally.

Model 8220 Cordless Rotary Tool

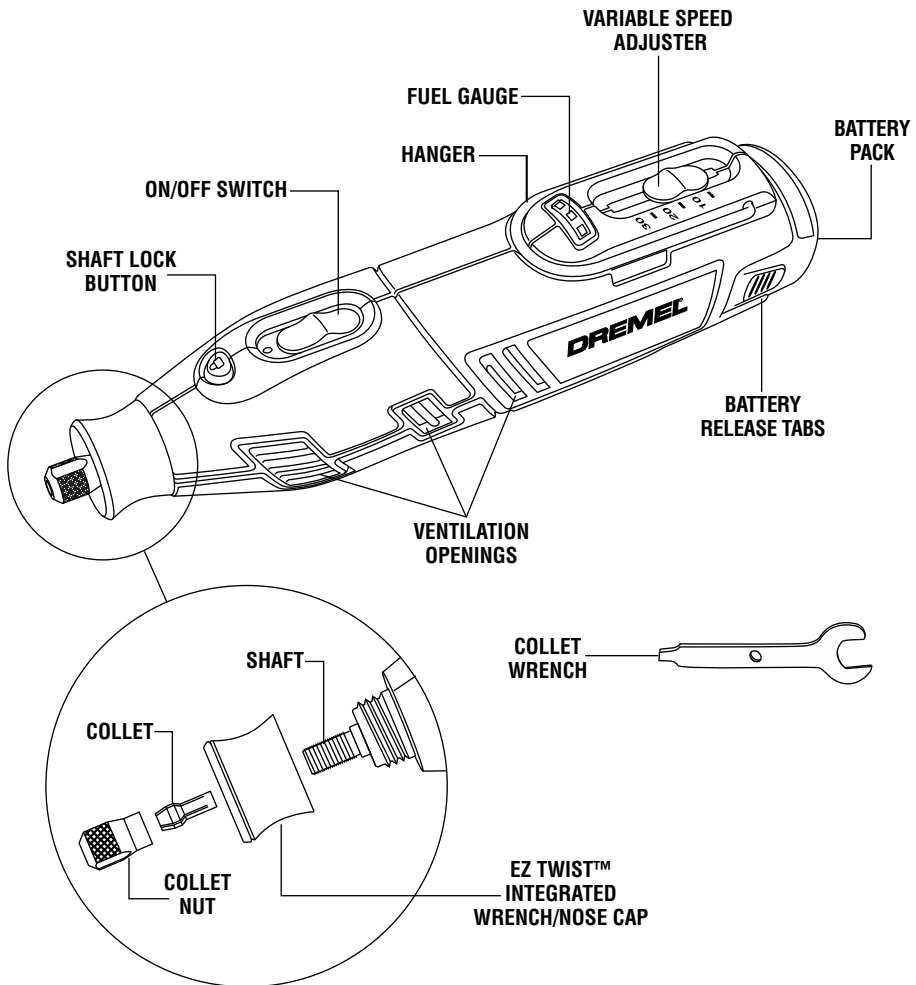

Model number 8220
 Voltage rating 10.8V/12V --- MAX
 Rated speed n 5,000 - 35,000/min
 Collet capacities 1/32, 1/16", 3/32", 1/8"

Charger 876
 Charge Time 1 Hour
 Voltage rating 120 V \sim 60 Hz
Battery pack 875, B812-01, B812-02, and B812-03
 Capacity 1.3 Ah, 1.5 Ah, or 2 Ah

Assembly

⚠ WARNING Disconnect battery pack from tool before making any assembly, adjustments or changing accessories. Such preventive safety measures reduce the risk of starting the tool accidentally.

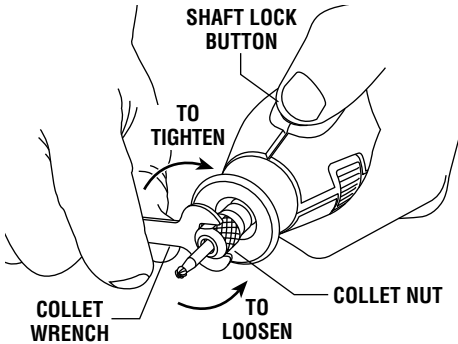

COLLET NUT — To loosen, first press shaft lock button and rotate the shaft by hand until the lock engages the shaft preventing further rotation. Your Dremel 8220 is equipped with a quick collet lock mechanism. This mechanism engages the output shaft in 8 separate locations on the shaft for easier operation.

⚠ CAUTION Do not engage lock while the Rotary Tool is running. With the shaft lock engaged use the collet wrench to loosen the collet nut if necessary. The collet nut must be loosely threaded on when inserting an accessory. Change accessories by inserting the new one into the collet as far as possible to minimize runout and

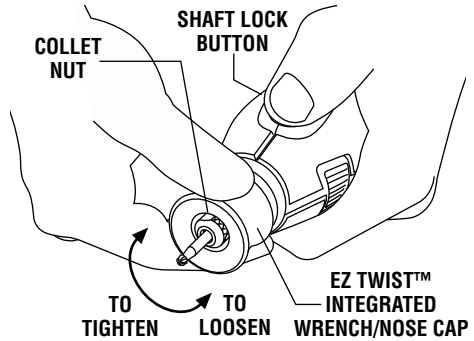

unbalance. With the shaft lock engaged, finger tighten the collet nut until the accessory shank is gripped by the collet. **Avoid excessive tightening of the collet nut when there is no bit inserted.**

EZ TWIST™ INTEGRATED WRENCH/NOSE CAP

The nose cap of your tool has an integrated wrench allowing you to loosen and tighten the collet nut without the use of the standard collet wrench. Unscrew the nose cap from the tool, line-up steel insert on inside of cap with collet nut. With the shaft lock engaged twist nose cap clockwise to tighten, and counter-clockwise to loosen.

COLLETS — Four different size collets (see illustration), to accommodate different shank sizes, are available for your Rotary Tool. To install a different collet, remove the collet nut and remove the old collet. Insert the slotted

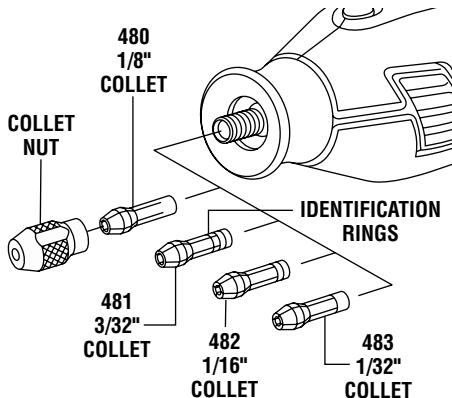

end of the collet in the hole in the end of the tool shaft. Replace collet nut on the shaft.

⚠ CAUTION Always use the collet which matches the shank size of the accessory you plan to use. Never force a larger diameter shank into a collet. **Note:** Most rotary tool kits do not include all four collets sizes.

COLLET IDENTIFICATION CHART

Collet sizes can be identified by the rings on the back end of collet.

1/32" Collet has one (1) ring.

1/16" Collet has two (2) rings.

3/32" Collet has three (3) rings.

1/8" Collet has no rings. **(Included in most tool kits on the tool)**

FIXING STUCK COLLETS – It is possible for a collet to get stuck within the collet nut especially if a collet nut is tightened onto the tool without a bit in place. If this happens, the collet can be removed from the collet nut by pushing the shank of an accessory into the hole in the collet nut. This should cause the collet to pop out of the collet nut.

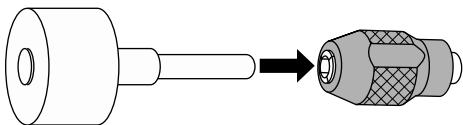

BALANCING ACCESSORIES – For precision work, it is important that all accessories be in good balance (much the same as the tires on your automobile). To true up or balance an

accessory, slightly loosen collet nut and give the accessory or collet a 1/4 turn. Retighten collet nut and run the Rotary Tool. You should be able to tell by the sound and feel if your accessory is running in balance. Continue adjusting in this fashion until best balance is achieved. To maintain balance on abrasive wheel points, before each use, with the wheel point secured in the collet, turn on the Rotary Tool and run the 415 Dressing Stone lightly against the revolving wheel point. This removes high spots and trues up the wheel point for good balance.

The hanger is provided for the use of hanging your tool while using the flex-shaft or for storage. If you do not use the hanger, snap it back into place so it will be out of the way while the tool is in use.

Operating Instructions

Dremel 8220

Thank you for purchasing the Dremel 8220. This product was designed by the many Dremel users who passionately use their rotary tools daily. This tool was designed to give you the ultimate performance when working on projects.

The Dremel 8220 is one of the MOST versatile cordless rotary tool available today. It has a wide speed range including a high performance motor that allows the tool to maintain its speed under load. The design of the tool also contains plenty of soft grip so the tool can be held comfortably in many positions. The quick collet lock mechanism makes locking the output shaft easier for changing accessories. You will appreciate the many applications that the Dremel 8220 can easily tackle.

Rotary Tool Introduction

The Rotary Tool has a small, powerful electric motor, is comfortable in the hand, and is made to accept a large variety of accessories including abrasive wheels, drill bits, wire brushes, polishers, engraving cutters, router bits, cutting wheels and attachments. Accessories come in a variety of shapes and permit you to do a number of different jobs. As you become familiar with the range of accessories and their uses, you will learn just how versatile the Rotary Tool is. You'll see dozens of uses you hadn't thought of before.

The real secret of the Rotary Tool is its speed. To understand the advantages of its high speed, you have to know that the standard portable electric drill runs at speeds up to 2,800 revolutions per minute. The Rotary Tool operates at speeds up to 30,000 revolutions per minute. The typical electric

drill is a low-speed, high torque tool; the Rotary Tool is just the opposite – a high-speed, low torque tool. The major difference to the user is that in the high speed tools, the speed combined with the accessory mounted in the collet does the work. You don't apply pressure to the tool, but simply hold and guide it. In the low speed tools, you not only guide the tool, but also apply pressure to it, as you do, for example, when drilling a hole.

It is this high speed, along with its compact size and wide variety of special accessories and attachments, that makes the Rotary Tool different from other tools. The speed enables it to do jobs low speed tools cannot do, such as cutting hardened steel, engraving glass, etc.

Getting the most out of your Rotary Tool is a matter of learning how to let this speed work for you. To learn about more uses and the versatility of Dremel accessories and attachments refer to this Owner's Manual or check our website at www.Dremel.com.

Using the Rotary Tool

The first step in learning to use the Rotary Tool is to get the "feel" of it. Hold it in your hand and feel its weight and balance. Feel the taper of the housing.



Always hold the tool away from your face. Accessories can be damaged during handling, and can fly apart as they come up to speed. This is not

common, but it does happen.

CAUTION Whenever you hold the tool, be careful not to cover the air vents with your hand. This blocks the air flow and causes the motor to overheat.

For best control in close work, grip the Rotary Tool like a pencil between your thumb and forefinger (Figure A).

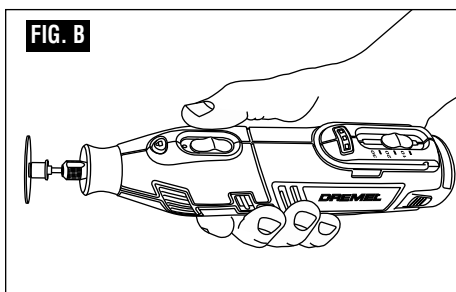
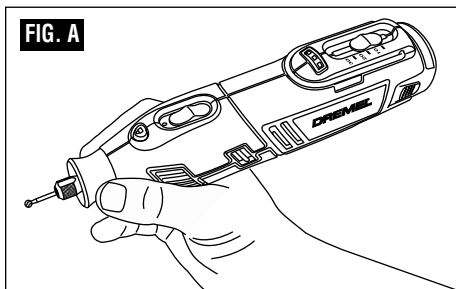

The "Golf Grip" method of holding the tool can be used for more aggressive operations such as grinding a flat surface or using cutoff wheels (Figure B).

Practice on scrap materials first to see how the Rotary Tool's high speed action performs. Keep in mind that the work is done by the speed of the tool and by the accessory in the collet. You should not lean on or push the tool during use.

Instead, lower the spinning accessory lightly to the work and allow it to touch the point at which you want cutting (or sanding or etching, etc.) to begin. Concentrate on guiding the tool over the work using very little pressure from your hand. Allow the accessory to do the work.

Usually, it is best to make a series of passes with the tool rather than attempt to do all the work in one pass. To make a cut, for example, pass the tool back and forth over the work, much as you would a small paint brush. Cut a little material on each pass until you reach the desired depth. For most work, the gentle touch is best. With it, you have the best control, are less likely to make errors, and will get the most efficient work out of the accessory.

**Questions or Problems? Call
1-800-437-3635
or check our website at
www.Dremel.com**

Operating Speeds

To select the right speed for each job, use a practice piece of material.

SLIDE "ON/OFF" SWITCH

The tool is switched "ON" by the slide switch located on the topside of the motor housing.

TO TURN THE TOOL "ON", slide the switch button forward.

TO TURN THE TOOL "OFF", slide the switch button backward.

HIGH PERFORMANCE MOTOR

Your tool is equipped with a high performance rotary tool motor. This motor expands the versatility of the rotary tool by driving additional attachments such as the Dremel Multi-Saw and Dremel Planer.

ELECTRONIC MONITORING

Your tool is equipped with an internal electronic monitoring system that provides a "soft start",

which will reduce the stresses that occur from a high torque start. The system also helps to maximize motor and battery performance by limiting the current to the tool when overload and stall conditions occur. The motor and battery pack are protected by limiting the current to the motor in these situations.

VARIABLE SPEED ADJUSTER

Your tool is equipped with a variable speed adjuster. The speed may be adjusted during operation by sliding the adjuster back or forth between any one of the settings.

You can refer to the charts on pages 27 – 30 to determine the proper speed, based on the material being worked and the type of accessory being used. These charts enable you to select both the correct accessory and the optimum speed at a glance.

The speed of Rotary Tool is controlled by setting this adjuster on the housing.

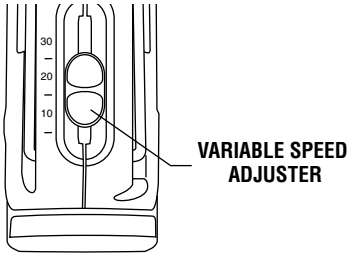

Settings for Approximate Revolutions.

Switch Setting	Speed Range
5	5,000-7,000 RPM
*10	7,000-10,000 RPM
15	13,000-17,000 RPM
20	18,000-23,000 RPM
25	23,000-27,000 RPM
30	28,000-35,000 RPM

* Wire Brush Setting.

Needs for Slower Speeds

Certain materials, however, (some plastics and precious metals, for example) require a relatively slow speed because at high speed the friction of the accessory generates heat and may cause damage to the material.

Slow speeds (15,000 RPM or less) usually are best for polishing operations employing the felt polishing accessories. They may also be best for working on delicate projects as “eggery” work, delicate wood carving and fragile model parts. **All brushing applications require lower speeds to avoid wire discharge from the holder.**

Higher speeds are better for carving, cutting, routing, shaping, cutting dadoes or rabbets in wood.

Hardwoods, metals and glass require high speed operation, and drilling should also be done at high speeds.

Many applications and accessories in our line will provide the best performance at full speed, but for certain materials, applications, and accessories, you need slower speeds, which is the reason our variable speed models are available.

To aid you in determining the optimum operational speed for different materials and different accessories, we have constructed a series of tables that appear on pages 27 – 30. By referring to these tables, you can discover the recommended speeds for each type of accessory. Look these tables over and become familiar with them.

Ultimately, the best way to determine the correct speed for work on any material is to practice for a few minutes on a piece of scrap, even after referring to the chart. You can quickly learn that a slower or faster speed is more effective just by observing what happens as you make a pass or two at different speeds. When working with plastic, for example, start at a slow rate of speed and increase the speed until you observe that the plastic is melting at the point of contact. Then reduce the speed slightly to get the optimum working speed.

Some rules of thumb in regard to speed:

1. Plastic and other materials that melt at low temperatures should be cut at low speeds.
2. Polishing, buffing and cleaning with any type of bristle brush must be done at speeds not greater than 15,000 RPM to prevent damage to the brush from bristles flying toward operator.
3. Wood should be cut at high speed.
4. Iron or steel should be cut at high speed. If a high speed steel cutter starts to chatter — this normally means it is running too slow.
5. Aluminum, copper alloys, lead alloys, zinc alloys and tin may be cut at various speeds, depending on the type of cutting being done. Use paraffin or other suitable lubricant on the cutter to prevent the cut material from adhering to the cutter teeth.

Increasing the pressure on the tool is not the answer when it is not performing as you think it should. Perhaps you should be using a different accessory, and perhaps an adjustment in speed would solve the problem. Leaning on the tool does not help.

Let speed do the work!

All Dremel Rotary Tool attachments are compatible with your tool, but you may experience reduced run times on the battery when using certain attachments.

Use only Dremel®, high-performance accessories.

FUEL GAUGE

This tool is equipped with a fuel gauge that tells you how much charge your battery has. A fully charged battery is indicated when all three LED lights are illuminated. As the battery discharges, the lights will turn off one by one until only one light is on. When the last light starts "flashing", the battery is almost empty. When the battery is dead, the tool will automatically turn off. This will be a sudden stop as opposed to a gradual winding down of the tool. Simply recharge the battery and reuse.

- 3 lights - 100% charge remaining
- 2 lights – 50% charge remaining
- 1 light - 25% charge remaining
- 1 "flashing" light - tool is about to shut off
- 3 "side to side" lights – battery charge is too low to run tool. Recharge the battery.
- 3 "flashing" lights – battery is too hot or too cold for use. Turn tool off and let battery return to normal operating temperature before resuming use.

INSERTING AND RELEASING BATTERY PACK

Release battery pack from tool by pressing on both sides of the battery release tabs and pull away from housing.

To insert battery, align battery and slide battery pack into tool until it locks into position. Do not force.

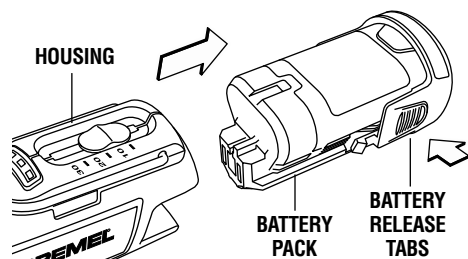

CHARGER INDICATORS, SYMBOLS AND MEANING

If the indicator lights are "OFF", the charger is not receiving power from power supply outlet.



If the green indicator light is "BLINKING", the battery pack is being fast-charged. Fast-charging will automatically stop when the battery pack is fully charged.

Fast-charging means that the battery will be fully charged in one hour.



If the green indicator light is "ON", the charger is plugged in but the battery pack is not inserted, or the battery pack is fully charged, or the battery pack is too hot or cold for fast-charging. The charger will automatically switch to fast-charging once a suitable temperature is reached.

IMPORTANT CHARGING NOTES

1. The charger was designed to fast charge the battery only when the battery temperature is between 32°F (0°C) and 113°F (45°C). If the battery pack is too hot or too cold, the charger will not fast charge the battery. (This may happen if the battery pack is hot from heavy use). When the battery temperature returns to between 32°F (0°C) and 113°F (45°C), the charger will automatically begin charging.
2. A substantial drop in operating time per

- charge may mean that the battery pack is nearing the end of its life and should be replaced.
3. Remember to unplug charger during storage period.
4. If battery does not charge properly:
 - a. Check for voltage at outlet by plugging in some other electrical device.
 - b. Check to see if outlet is connected to a light switch which turns power "off" when lights are turned off.

c. Check battery pack terminals for dirt. Clean with cotton swab and alcohol if necessary.

d. If you still do not get proper charging,

take or send tool, battery pack and charger to your local Dremel Service Center.

Note: Use of chargers or battery packs not sold by Dremel will void the warranty.

Charging Battery Pack

876 1-HOUR CHARGER

Plug charger cord into your standard power outlet, then insert battery pack into charger.

The charger's green indicator light will begin to "BLINK". This indicates that the battery is receiving a fast charge. Fast-charging will automatically stop when the battery pack is fully charged.

When the indicator light stops "BLINKING" (and becomes a steady green light) fast charging is complete.

The battery pack may be used even though the light may still be blinking. The light may require more time to stop blinking depending on temperature.

The purpose of the green light is to indicate that the battery pack is fast-charging. It does not indicate the exact point of full charge. The light will stop blinking in less time if the battery pack was not completely discharged.

When charging several batteries in sequence, the charge time may slightly increase.

When the battery pack is fully charged, unplug the charger (unless you're charging another battery pack) and slip the battery pack back into the tool.

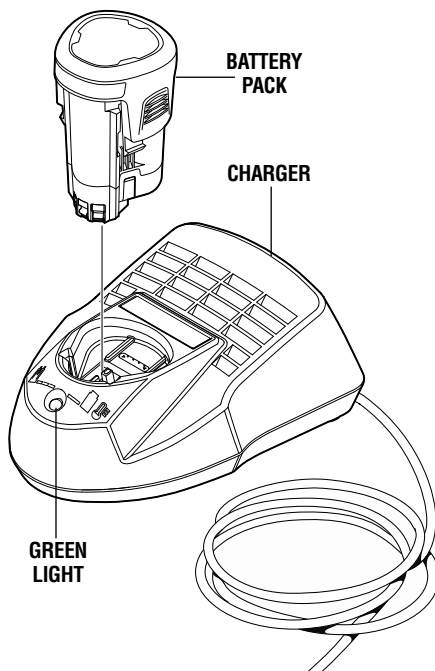

Maintenance

Service

⚠ WARNING **NO USER SERVICEABLE PARTS INSIDE.** Preventive maintenance performed by unauthorized personnel may result in misplacing of internal wires and components which could cause serious hazard. We recommend that all tool service be performed by a Dremel Service Center. **SERVICEMEN:** Disconnect tool and/or charger from power source before servicing.

BATTERIES

Be alert for battery packs that are nearing their end of life. If you notice decreased tool performance or significantly shorter running time between charges then it is time to replace the battery pack. Failure to do so can cause the tool to operate improperly or damage the charger.

D.C. MOTORS

The motor in your tool has been engineered for many hours of dependable service. To maintain peak efficiency of the motor, we

recommend it be examined every six months. Only a genuine Dremel replacement motor specially designed for your tool should be used.

Cleaning

⚠ WARNING To avoid accidents, always disconnect the tool and/or charger from the power supply before cleaning. The tool may be cleaned most effectively with compressed dry air. **Always wear safety goggles when cleaning tools with compressed air.**

Ventilation openings and switch levers must be kept clean and free of foreign matter. Do not attempt to clean by inserting pointed objects through opening.

⚠ CAUTION Certain cleaning agents and solvents damage plastic parts. Some of these are: gasoline, carbon tetrachloride, chlorinated cleaning solvents, ammonia and household detergents that contain ammonia.

Extension Cords

⚠ WARNING If an extension cord is necessary, a cord with adequate size conductors that is capable of carrying the current necessary for your tool must be used. This will prevent excessive voltage drop, loss of power or overheating. Grounded tools must use 3-wire extension cords that have 3-prong plugs and receptacles.

NOTE: The smaller the gauge number, the higher the cord capacity.

RECOMMENDED SIZES OF EXTENSION CORDS 120 VOLT ALTERNATING CURRENT TOOLS

Tool's Ampere Rating	Cord Size in A.W.G.				Wire Sizes in mm ²			
	Cord Length in Feet				Cord Length in Meters			
	25	50	100	150	15	30	60	120
3-6	18	16	16	14	0.75	0.75	1.5	2.5
6-8	18	16	14	12	0.75	1.0	2.5	4.0
8-10	18	16	14	12	0.75	1.0	2.5	4.0
10-12	16	16	14	12	1.0	2.5	4.0	–
12-16	14	12	–	–	–	–	–	–

Dremel Accessories

WARNING Use only Dremel®[®], high-performance accessories. Other accessories are not designed for this tool and may lead to personal injury or property damage.

Store accessories in a dry and temperate environment to avoid corrosion and deterioration.

The number and variety of accessories for the Rotary Tool are almost limitless. There is a category suited to almost any job you might have to do and a variety of sizes and shapes within each category which enables you to get the perfect accessory for every need.

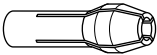

COLLETS

If you expect to use a variety of accessories, we recommend that in the beginning you purchase a complete set of four collets. Store these so that you will have the proper size of collet for any accessory or drill bit you want to use. **Currently, the 1/8", 3/32", 1/32" and 1/16" collets accommodate all of the available Dremel accessories. 1/8" collets are included in most rotary tool kits.**

MANDRELS

A mandrel is a shank with a threaded or screw head, which are required when you use polishing accessories, cutting wheels, sanding discs, and polishing points. The reason mandrels are used is that sanding discs, cutting wheels and similar accessories must be replaced frequently. The mandrel is a permanent shank, allowing you to replace only the worn head when necessary, thus saving the expense of replacing the shaft each time.

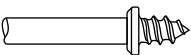

Screw Mandrel No 401

This is a screw mandrel used with the felt polishing tip and felt polishing wheels. 1/8" shank.



Small Screw Mandrel No 402

This is a mandrel with a small screw at its tip, and is used with emery and fiberglass cutting wheels, sanding discs and polishing wheels. 1/8" shank.

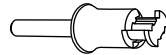

EZ Lock™

EZ Lock Mandrel No 402

The Dremel EZ Lock makes accessory changes easy as PULL - TWIST - RELEASE. The one-piece mandrel design simplifies the process of changing cutting wheels, buffs and detail abrasive brushes (EZ Lock compatible accessories).

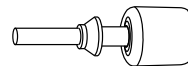

EZ Drum™ Mandrel No EZ407SA

The Dremel EZ Drum makes accessory changes easy as PULL - INSERT - PRESS DOWN. The one-piece mandrel design simplifies the process of changing sanding bands.

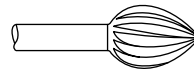

High Speed Cutters

Available in many shapes, high speed cutters are used in carving, cutting and slotting in wood, plastics and soft metals such as aluminum, copper and brass. These are the accessories to use for freehand routing or carving in wood or plastic, and for precision cutting. Made of high quality steel. 1/8" shank.



Tungsten Carbide Cutters

These are tough, long-lived cutters for use on hardened steel, fired ceramics and other very hard materials. They can be used for engraving on tools and garden equipment. 1/8" shanks.

Dremel Accessories (Continued)

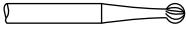

Engraving Cutters

This group has a wide variety of sizes and shapes, and are made for intricate work on ceramics (greenware), wood carvings, jewelry and scrimshaw. They often are used in making complicated printed circuit boards. They should not be used on steel and other very hard materials but are excellent on wood, plastic and soft metals. 1/8" shank.

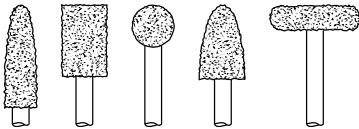

Structured Tooth Tungsten Carbide Cutters

Fast cutting, needle-sharp teeth for greater material removal with minimum loading. Use on fiberglass, wood, plastic, epoxy and rubber. 1/8" shank.

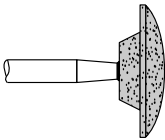

Aluminum Oxide Grinding Stones (red/brown)

Round, pointed, flat — you name the shape and there is one available in this category. These are made of aluminum oxide and cover virtually every possible kind of grinding application. Use them for sharpening lawn mower blades, screwdriver tips, knives, scissors, chisels and other cutting tools. Use to remove flash from metal castings, deburring any metal after cutting, smoothing welded joints, grinding off rivets and removing rust. These grinding stones can be resharped with a dressing stone. In machine shops, high speed drills and cutters normally are ground with aluminum oxide wheels. 1/8" shank.

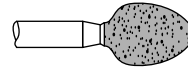

Silicon Carbide Grinding Stones (blue/green)

Tougher than aluminum oxide points, these are made especially for use on hard materials such as glass and ceramics. Typical uses might be the removal of stilt marks and excess glaze on ceramics and engraving on glass. 1/8" shank.

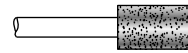

Diamond Wheel Points

Excellent for fine detail work on wood, jade, ceramic, glass and other hard material. Bits are covered with diamond particles. 1/8" shanks. (Not recommended for drilling)

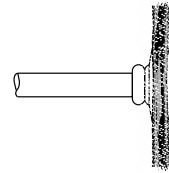

Wire Brushes

Three different shapes of wire brushes are available. **For best results wire brushes should be used at speeds not greater than 15,000 RPM. Refer to Operating Speeds section for proper tool speed setting.** The three shapes come in three different materials: stainless steel, brass and carbon wire. The stainless steel perform well on pewter, aluminum, stainless steel, and other metals, without leaving "after-rust". Brass brushes are non sparking, and softer than steel; making them good for use on soft metal like gold, cooper and brass. The carbon wire brushes are good for general purpose cleaning.

Dremel Accessories (Continued)

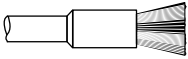

Bristle Brushes

These are excellent cleaning tools on silverware, jewelry and antiques. The three shapes make it possible to get into tight corners and other difficult places. Bristle brushes can be used with polishing compound for faster cleaning or polishing.

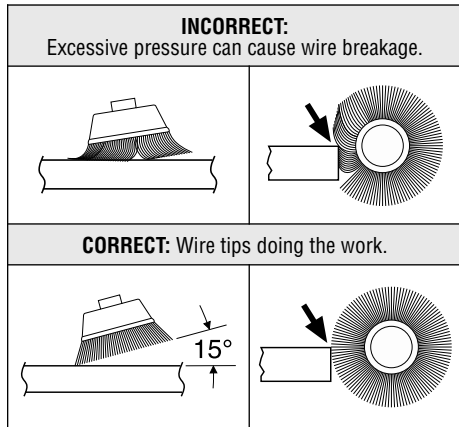

Brushing Pressure

1. Remember, the tips of a wire brush do the work. Operate the brush with the lightest pressure so only the tips of the wire come in contact with the work.
2. If heavier pressures are used, the wires will be overstressed, resulting in a wiping action; and if this is continued, the life of the brush will be shortened due to wire fatigue.
3. Apply the brush to the work in such a way that as much of the brush face as possible is in full contact with the work. Applying the side or edge of the brush to the work will result in wire breakage and shortened brush life.

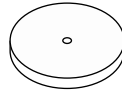

Polishing Accessories

These include an impregnated polishing wheel for bringing metal surfaces to smooth finish; a felt polishing tip and felt polishing wheel, and cloth polishing wheel, all used for polishing plastics, metals, jewelry and small parts. Also included in this group is a polishing compound (No. 421) for use with the felt and cloth polishers.

Polishing points make a very smooth surface, but a high luster is obtained using felt or cloth wheels and polishing compound.

For best results polishing accessories should be used at speeds not greater than 15,000 RPM.

No polishing compound is needed when using the 425 Polishing Wheel.

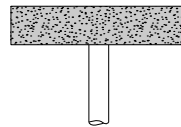

Aluminum Oxide Abrasive Wheels

Use to remove paint, deburr metal, polish stainless steel and other metals. Available in medium grit. 1/8" shank.

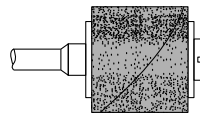

Sanding Accessories

Sanding discs in fine, medium and coarse grades are made to fit mandrel No. 402 and EZ407. They can be used for nearly any small sanding job you might have, from model making to fine furniture finishing. In addition, there is the drum sander, a tiny drum which fits into the Rotary Tool and makes it possible to shape wood, smooth fiberglass, sand inside curves and other diffi-

Dremel Accessories (Continued)

cult places, and other sanding jobs. You replace the sanding bands on the drum as they become worn and lose their grit. Bands come in fine medium and coarse grades. Flapwheels grind and polish flat or contoured surfaces. They are used most effectively as a finishing sander after heavier surface sanding and material removal is completed. Flapwheels come in fine and coarse grades. Buffs are a great finishing accessory for cleaning and light sanding. They work effectively on metal, glass, wood, aluminum and plastics. Coarse and medium buffs are sold together. All buffs are sold individually. **Do not exceed 15,000 RPM in speed. 1/8" shank.**

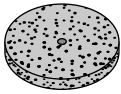

Grinding Wheel

Use for deburring, removing rust, and general purpose grinding. Use with Mandrel #402.

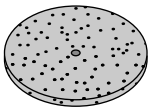

EZ Lock™

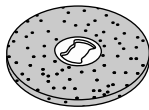

Cutting Wheels

These thin discs of emery or fiberglass are used for slicing, cutting off and similar operations. Use them for cutting off frozen bolt heads and nuts, or to reslot a screw head which has become so damaged that the screwdriver won't work in it. Fine for cutting BX cable, small rods, tubing, cable and cutting rectangular holes in sheet metal.



Drywall Cutting Bit

Gives you fast, clean cuts in drywall. Use with Dremel No 565/566 Cutting Guide attachment.



Tile Cutting Bit

Cuts ceramic wall tile, cement board, and plaster. Use with Dremel No 565/566 Cutting Guide attachment.



Spiral Cutting Bit

Cuts through all types of wood and wood composites. Use with Dremel No 565/566 Cutting Guide attachment.

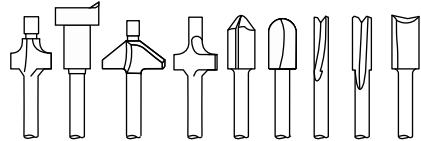

High Speed Router Bits

For routing, inlaying, and mortising in wood and other soft materials. Use with Dremel No. 335 Router attachment and No. 231 Shaper/Router table.

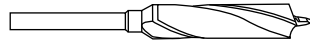

Brad Point Drill Bits

Titanium coated brad points stay on center and begin drilling immediately. For use on wood. Size 1/8", 5/32", 3/16", 1/4", 1/8" shank.



HSS Drill Bits

HSS drill bit for use in metal and plastic. Size 1/8", 7/64", 3/32", 5/64", 1/16", 3/64", 1/32". Shank size matches the drill bit size. Different collet size (481, 482, 483) or Dremel chuck (4486) required according to drill bit being used.

Dremel Accessories (Continued)

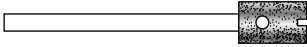

Glass Drill Bits

Diamond tipped drill bits for use on glass and ceramic wall tile. Lubricant included.

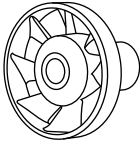

Collet Fan

Blows dust away for greater visibility to work piece. Great for sanding, engraving and carving. Do not use dust blower to stop or slow down the tool. Do not contact dust blower with fingers or workpiece during use.

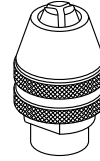

Dremel Chuck

This chuck allows you to quickly and easily change accessories on Dremel Rotary Tools without changing collets. Accepts accessories with 1/32" - 1/8" shank. Read instruction manual. Insert and securely tighten the shank of the accessory well within the jaws of the chuck.

Replacing Screw Mandrel Accessories

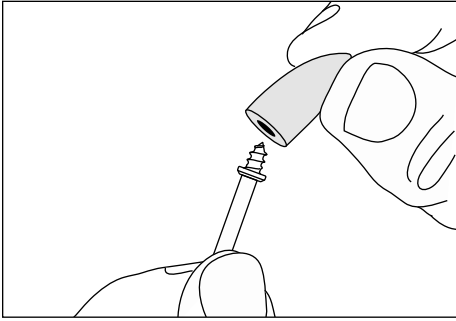

Mandrel No. 401 is used with the felt polishing tip and wheels. Thread the tip on to the screw carefully. The felt tip must thread

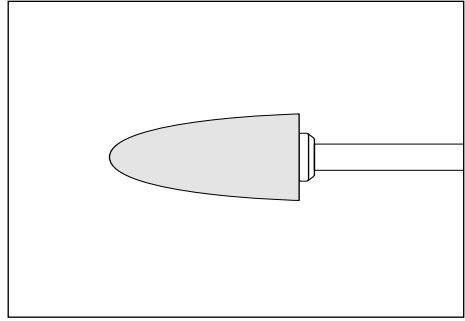

down straight on the screw Mandrel, and be turned all the way to the collar.

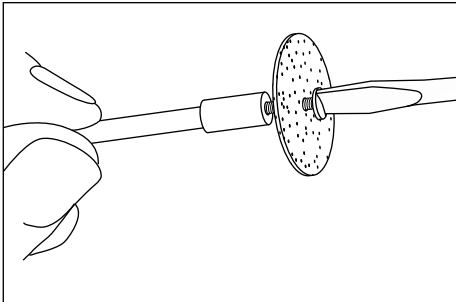

Mandrel N° 402 has a small screw at its tip, and is used with emery cutting wheels and sanding discs. Higher speeds, usually

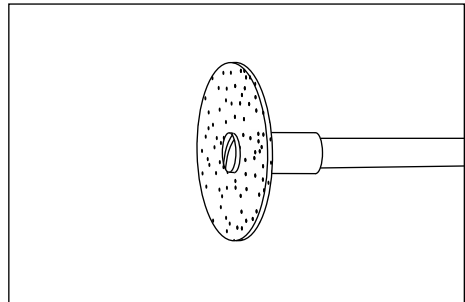

maximum, are best for most work, including cutting steel. Which is shown here.

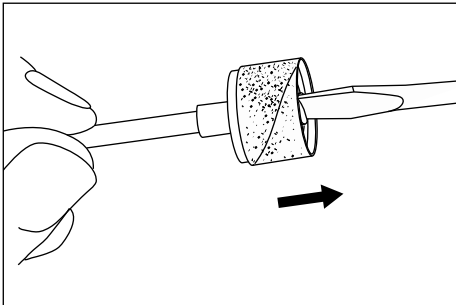

To replace a band on the **Drum Sander**, loosen the screw without removing it to contract the drum then slide the old band off. Slide the new sanding band on and then expand the drum by tightening the screw once again.

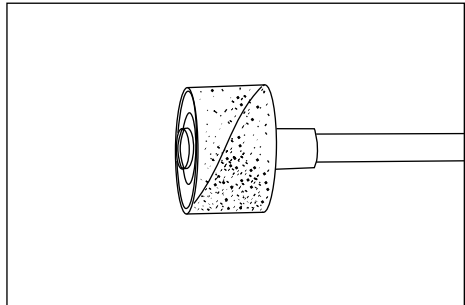

⚠ WARNING Before each use, check to make certain that all components are assembled to accessory shank and that the drum is sufficiently expanded to secure the band during use. If sanding band is loose on the drum during operation it may “fly” off and strike you or bystanders.

EZ Lock™ Operating Instructions

EZ Lock™ Mandrel No. EZ402 has a spring loaded sleeve and is used with cutting wheels, abrasive buffs and polishing cloth.

⚠ WARNING Always make sure the rotary tool is “OFF” and disconnect the plug from the power source or the battery pack from the tool before changing accessories. Such preventative safety measures reduce the risk of starting the power tool accidentally.

Always make sure accessory is properly seated on mandrel before use. Incorrect seating of accessory on mandrel may lead to personal injury or property damage.

To load accessory:

1. Place EZ Lock™ mandrel into collet as deep as possible and tighten collet nut.

Note: There is a blue spacer that will bottom out on the collet nut, setting the mandrel to the correct depth. When using with Dremel chuck, back the mandrel out slightly before tightening.

2. Pull spring-loaded sleeve DOWN towards tool with one hand and hold. You can brace the tool on the body or work-bench for extra leverage (Fig. 1).
3. With the other hand, align bowtie shape on cut-off wheel with mandrel and make sure metal insert is facing away from the tool (Fig. 2).

4. Place wheel on the mandrel to a point just below the bowtie on the mandrel and twist 90 degrees until the bowtie shape on the wheel aligns with the sleeve. Release sleeve. Wheel should lock in place (Fig. 3).

5. When mounting sanding and polishing accessories, align bowtie with metal insert on bottom of accessory (Fig. 4 & 5).

To check for proper seating, hold shaft lock button and twist accessory. Accessory will not be able to rotate on mandrel.

To unload accessory:

1. Pull spring-loaded sleeve DOWN toward tool with one hand (Fig. 1).
2. Hold sleeve down while twisting accessory 90 degrees.
3. Remove accessory.

During use

Avoid damage to EZ lock™ mandrel by not letting it contact the workpiece.

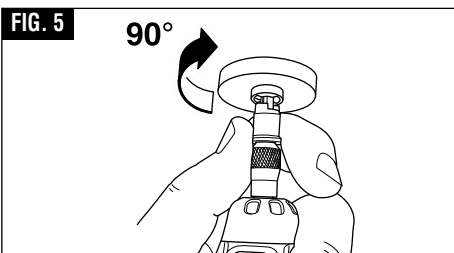
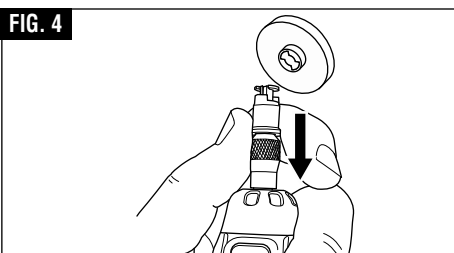
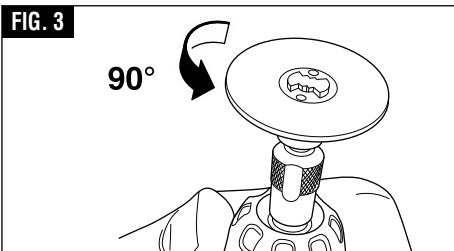
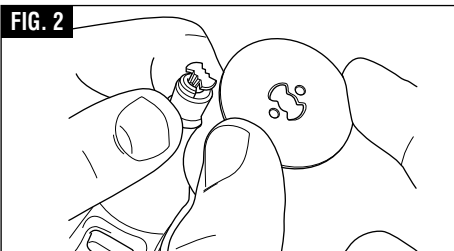
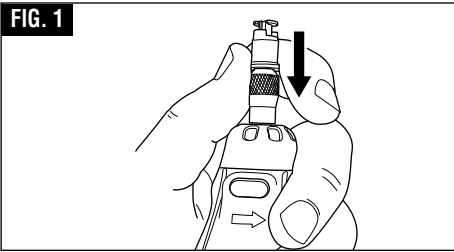

EZ Drum™ Operating Instructions

EZ Drum™ Mandrel No. EZ407SA has a spring loaded sleeve and is used with sanding bands.

⚠ WARNING Always make sure the rotary tool is "OFF" and disconnect the plug from the power source or the battery pack from the tool before changing accessories. Such preventative safety measures reduce the risk of starting the power tool accidentally.

Always make sure accessory is properly seated on mandrel before use. Incorrect seating of accessory on mandrel may lead to personal injury or property damage.

To load accessory:

1. As indicated, place two fingers underneath the mandrel and pull firmly up. This will place the EZ Drum™ in the "unlocked" position (Fig. 1).
2. Keeping two fingers beneath the mandrel, slide the sanding band down until the entire blue mandrel is covered (Fig. 2).
3. To return to "locked" position, press firmly down on the top of the mandrel (Fig. 3).

Removing the sanding band on the mandrel:

1. Place two fingers underneath the mandrel and pull firmly up. This will place the EZ Drum™ in the "unlocked" position (Fig. 1).
2. Sanding band will now easily slide off mandrel (Fig. 2). Do not squeeze sanding band when removing from EZ Drum™ mandrel. This can lead to rubber band pulling off mandrel and becoming inoperable.

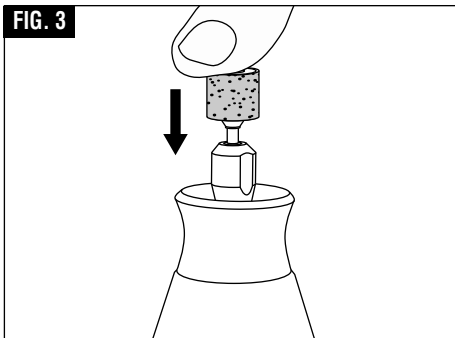
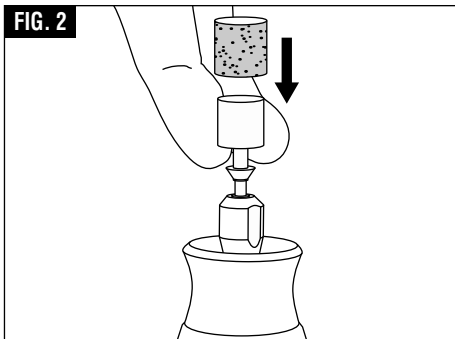
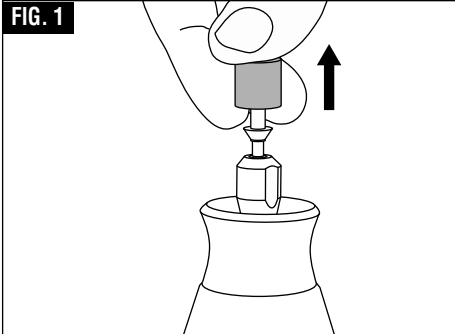

Speed Settings

Note: Each number settings listed in the speed charts = x 1,000 RPM

- * Speed for light cuts, Caution - burning on deep grooves.
- Depending on cutting direction relative to grain.

High Speed Cutters								
Catalog Number	Soft Wood	Hard Wood	Laminates /Plastics	Steel	Aluminum, Brass, etc.	Shell/ Stone	Ceramic	Glass
100, 121, 131	25-35	25-35	12-17	12-17	18-24	-	-	-
114, 124, 134, 144	25-35	12-17	9-11	12-17	12-17	-	-	-
118, 190, 191, 192, 193, 194	25-35	25-35	9-11	12-17	25-35	-	-	-
116, 117, 125, 196	25-35	12-17	9-11	12-17	12-17	-	-	-
115	25-35	25-35	9-11	12-17	12-17	-	-	-
198, 199	25-35	18-24	9-11	12-17	12-17	-	-	-

Engraving Cutters								
Catalog Number	Soft Wood	Hard Wood	Laminates /Plastics	Steel	Aluminum, Brass, etc.	Shell/ Stone	Ceramic	Glass
105, 108	25-35	25-35	18-24	9-11	12-17	-	-	-
106, 107, 109, 110	25-35	25-35	12-17	9-11	12-17	-	-	-
111	25-35*	25-35*	18-24*	9-11	12-17	-	-	-
112, 113	25-35*	25-35*	12-17*	9-11	12-17	-	-	-

Diamond Wheel Points								
Catalog Number	Soft Wood	Hard Wood	Laminates /Plastics	Steel	Aluminum, Brass, etc.	Shell/ Stone	Ceramic	Glass
7103, 7105, 7117, 7120, 7122, 7123, 7134, 7144	25-35	18-24	-	-	-	25-35	25-35	25-35

Structured Tooth Tungsten Carbide Cutters								
Catalog Number	Soft Wood	Hard Wood	Laminates /Plastics	Steel	Aluminum, Brass, etc.	Shell/ Stone	Ceramic	Glass
9931, 9932, 9933, 9934, 9935, 9936	25-35	18-24	9-11	-	12-17	-	-	-

Speed Settings (Continued)

Note: Each number settings listed in the speed charts = x 1,000 RPM

- * Speed for light cuts, Caution - burning on deep grooves.
- Depending on cutting direction relative to grain.

Tungsten Carbide Cutters								
Catalog Number	Soft Wood	Hard Wood	Laminates /Plastics	Steel	Aluminum, Brass, etc.	Shell/ Stone	Ceramic	Glass
9901, 9902, 9903, 9904, 9905, 9906, 9912	25-35	18-24	9-11	25-35	12-17	18-24	18-35	18-35
9909, 9910, 9911	-	-	-	-	-	18-24	18-35	18-35

High Speed Router Bits								
Catalog Number	Soft Wood	Hard Wood	Laminates /Plastics	Steel	Aluminum, Brass, etc.	Shell/ Stone	Ceramic	Glass
612, 640	25-35*	18-24•	-	-	-	-	-	-
615, 617, 618	25-35*	25-35•	-	-	-	-	-	-
650, 652, 654	25-35*	18-24•	-	-	-	-	-	-

Silicon Carbide Grinding Stones (blue/green)								
Catalog Number	Soft Wood	Hard Wood	Laminates /Plastics	Steel	Aluminum, Brass, etc.	Shell/ Stone	Ceramic	Glass
83142, 83322, 83702, 84922, 85422, 85602, 85622	-	-	12-17	25-35	9-11	12-17	25-35	25-35

Abrasive Wheels / Points								
Catalog Number	Soft Wood	Hard Wood	Laminates /Plastics	Steel	Aluminum, Brass, etc.	Shell/ Stone	Ceramic	Glass
516	4-6	4-6	-	18-24	12-17	-	-	-
500	4-6	4-6	-	18-24	9-17	-	-	-
EZ541GR	-	-	-	12-24	9-17	-	-	-

Aluminum oxide grinding stones (orange/brown)								
Catalog Number	Soft Wood	Hard Wood	Laminates /Plastics	Steel	Aluminum, Brass, etc.	Shell/ Stone	Ceramic	Glass
541, 903, 911, 921, 932, 941, 945, 952, 953, 954, 971, 997, 8153, 8175, 8193, 8215	25-35	25-35	-	18-24	9-11	12-17	25-35	-

Speed Settings (Continued)

Note: Each number settings listed in the speed charts = x 1,000 RPM

- * Speed for light cuts, Caution - burning on deep grooves.
- Depending on cutting direction relative to grain.

Chain Saw Sharpening Stones								
Catalog Number	Soft Wood	Hard Wood	Laminates /Plastics	Steel	Aluminum, Brass, etc.	Shell/ Stone	Ceramic	Glass
453, 454, 455	-	-	-	25-35	-	-	-	-

Cutting Accessories								
Catalog Number	Soft Wood	Hard Wood	Laminates /Plastics	Steel	Aluminum, Brass, etc.	Shell/ Stone	Ceramic	Glass
409, 420, 426, 540, EZ409	-	-	5-11	25-35	25-35	25-35	25-35	-
543, EZ544	25-35	18-35	5-11	-	-	-	-	-
545, EZ545	18-35	18-24	-	-	-	12-24	12-24	-
560	For use on drywall. For best results, use at 30,000 rpm							
561	12-35	12-35	5-11	-	25-35	-	-	-
562	-	-	-	-	-	-	25-35	-
EZ456	-	-	-	25-35	25-35	-	-	-
EZ476	-	-	5-11	-	-	-	-	-

Polishing Accessories								
Catalog Number	Soft Wood	Hard Wood	Laminates /Plastics	Steel	Aluminum, Brass, etc.	Shell/ Stone	Ceramic	Glass
461, 462, 463	-	-	-	18-24	18-24	18-24	18-24	18-24
414, 422, 429	-	-	-	12-17	12-17	12-17	12-17	12-17
425, 427	-	-	-	18-24	18-24	-	-	-
423E	-	-	-	12-24	5-8	5-8	5-8	12-24

Wire Brushes								
Catalog Number	Soft Wood	Hard Wood	Laminates /Plastics	Steel	Aluminum, Brass, etc.	Shell/ Stone	Ceramic	Glass
403, 404, 405	9-11	9-11	5-11	12-17	5-8	-	-	-
428, 442, 443	9-11	9-11	5-8	9-11	9-11	-	-	-
530, 531, 532	-	9-11	-	9-11	-	-	-	-
535, 536, 537	9-11	9-11	-	9-11	9-11	9-11	-	-

Sanding Bands and Discs								
Catalog Number	Soft Wood	Hard Wood	Laminates /Plastics	Steel	Aluminum, Brass, etc.	Shell/ Stone	Ceramic	Glass
407, 408, 430, 431, 432, 438, 439, 440, 444	5-35	5-35	5-17	25-35	25-35	5-35	5-35	-
411, 412, 413	12-17	12-17	5-8	-	5-8	-	-	-

Speed Settings (Continued)

Note: Each number settings listed in the speed charts = x 1,000 RPM

- * Speed for light cuts, Caution - burning on deep grooves.
- Depending on cutting direction relative to grain.

Flapwheels								
Catalog Number	Soft Wood	Hard Wood	Laminates /Plastics	Steel	Aluminum, Brass, etc.	Shell/ Stone	Ceramic	Glass
502, 503, 504, 505	25-35	18-24	5-8	25-35	18-35	-	-	-

Finishing Abrasive Buffs								
Catalog Number	Soft Wood	Hard Wood	Laminates /Plastics	Steel	Aluminum, Brass, etc.	Shell/ Stone	Ceramic	Glass
511E, 512E	12-17	12-17	9-11	12-17	12-17	-	-	-

Detail Abrasive Brushes								
Catalog Number	Soft Wood	Hard Wood	Laminates /Plastics	Steel	Aluminum, Brass, etc.	Shell/ Stone	Ceramic	Glass
EZ471SA, EZ472SA, EZ473SA	5-17	5-17	5-17	5-17	5-17	-	-	-

Drill Bit								
Catalog Number	Soft Wood	Hard Wood	Laminates /Plastics	Steel	Aluminum, Brass, etc.	Shell/ Stone	Ceramic	Glass
150	25-35	18-35	5-11	-	12-17	-	-	-

Glass Drilling Bits								
Catalog Number	Soft Wood	Hard Wood	Laminates /Plastics	Steel	Aluminum, Brass, etc.	Shell/ Stone	Ceramic	Glass
662DR, 663DR	-	-	-	-	-	5-17	5-17	5-17

Grout Removal Bits								
Catalog Number	Soft Wood	Hard Wood	Laminates /Plastics	Steel	Aluminum, Brass, etc.	Shell/ Stone	Ceramic	Glass
569, 570	For use on wall and floor grout					-	12-24	-

Dremel® Limited Warranty

Your Dremel product is warranted against defective material or workmanship for a period of two years from date of purchase. In the event of a failure of a product to conform to this written warranty, please take the following action:

1. DO NOT return your product to the place of purchase.
2. Carefully package the product by itself, with no other items, and return it, freight prepaid, along with:
 - A. A copy of your dated proof of purchase (please keep a copy for yourself).
 - B. A written statement about the nature of the problem.
 - C. Your name, address and phone number to:

UNITED STATES
Dremel Service Center
4915 21st Street
Racine, WI 53406

OR

CANADA
 Giles Tool Agency
 47 Granger Av.
 Canada M1K 3K9 1-416-287-3000

OUTSIDE CONTINENTAL UNITED STATES CONTINENTAL UNITED STATES

See your local distributor or write to Dremel, 4915 21st Street Racine, WI 53406

We recommend that the package be insured against loss or in transit damage for which we cannot be responsible.

This warranty applies only to the original registered purchaser. DAMAGE TO THE PRODUCT RESULTING FROM TAMPERING, ACCIDENT, ABUSE, NEGLIGENCE, UNAUTHORIZED REPAIRS OR ALTERATIONS, UNAPPROVED ATTACHMENTS OR OTHER CAUSES UNRELATED TO PROBLEMS WITH MATERIAL OR WORKMANSHIP ARE NOT COVERED BY THIS WARRANTY.

No employee, agent, dealer or other person is authorized to give any warranties on behalf of Dremel. If Dremel inspection shows that the problem was caused by problems with material or workmanship within the limitations of the warranty, Dremel will repair or replace the product free of charge and return product prepaid. Repairs made necessary by normal wear or abuse, or repair for product outside the warranty period, if they can be made, will be charged at regular factory prices.

DREMEL MAKES NO OTHER WARRANTY OF ANY KIND WHATEVER, EXPRESSED OR IMPLIED, AND ALL IMPLIED WARRANTIES OF MERCHANTABILITY AND FITNESS FOR A PARTICULAR PURPOSE WHICH EXCEED THE ABOVE MENTIONED OBLIGATION ARE HEREBY DISCLAIMED BY DREMEL AND EXCLUDED FROM THIS LIMITED WARRANTY.

This warranty gives you specific legal rights and you may also have other rights which vary from state to state. The obligation of the warrantor is solely to repair or replace the product. The warrantor is not liable for any incidental or consequential damages due to any such alleged defect. Some states do not allow the exclusion or limitation of incidental or consequential damages, so the above limitations or exclusion may not apply to you.

For prices and warranty fulfillment in the continental United States, contact your local Dremel distributor.

Exportado por: © Robert Bosch Tool Corporation Mt. Prospect, IL 60056 -2230, E.U.A.

Importado a México por: Robert Bosch, S. de R.L. de C.V.
 Calle Robert Bosch No. 405 - 50071 Toluca, Edo. de Méx. - México
 Tel. 052 (722) 279 2300 ext 1160 / Fax. 052 (722) 216-6656



1 6 0 0 A 0 1 2 F X A A