

Thermal overload relay TF42

Thermal overload relays are economic electromechanical protection devices for the main circuit. They are used mainly to protect motors against overload and phase failures. Starter combinations are setup together with contactors.



Description

- Overload protection – trip class 10
- Phase loss sensitivity
- Temperature compensation from -25 ... +60 °C
- Adjustable current setting for overload protection
- Automatic or manual reset selectable
- Suitable for three- and single-phase application
- Trip-free mechanism
- Status indication
- STOP and TEST function
- Direct mounting onto block contactors
- Sealable cover

Approvals

 cULus UL 508

 CB scheme

Marks

 CE

Order data

TF42 screw terminal
For AF contactors



Setting range	Type	Order code	Packing unit	Weight per PCE
A			PCE	kg
0.10 ... 0.13	TF42-0.13	1SAZ721201R1005	1	0.130
0.13 ... 0.17	TF42-0.17	1SAZ721201R1008	1	0.130
0.17 ... 0.23	TF42-0.23	1SAZ721201R1009	1	0.130
0.23 ... 0.31	TF42-0.31	1SAZ721201R1013	1	0.130
0.31 ... 0.41	TF42-0.41	1SAZ721201R1014	1	0.130
0.41 ... 0.55	TF42-0.55	1SAZ721201R1017	1	0.130
0.55 ... 0.74	TF42-0.74	1SAZ721201R1021	1	0.130
0.74 ... 1.00	TF42-1.0	1SAZ721201R1023	1	0.130
1.00 ... 1.30	TF42-1.3	1SAZ721201R1025	1	0.130
1.30 ... 1.70	TF42-1.7	1SAZ721201R1028	1	0.130
1.70 ... 2.30	TF42-2.3	1SAZ721201R1031	1	0.130
2.30 ... 3.10	TF42-3.1	1SAZ721201R1033	1	0.130
3.10 ... 4.20	TF42-4.2	1SAZ721201R1035	1	0.130
4.20 ... 5.70	TF42-5.7	1SAZ721201R1038	1	0.130
5.70 ... 7.60	TF42-7.6	1SAZ721201R1040	1	0.130
7.60 ... 10.0	TF42-10	1SAZ721201R1043	1	0.130
10.0 ... 13.0	TF42-13	1SAZ721201R1045	1	0.130
13.0 ... 16.0	TF42-16	1SAZ721201R1047	1	0.130
16.0 ... 20.0	TF42-20	1SAZ721201R1049	1	0.145
20.0 ... 24.0	TF42-24	1SAZ721201R1051	1	0.145
24.0 ... 29.0	TF42-29	1SAZ721201R1052	1	0.145
29.0 ... 35.0	TF42-35	1SAZ721201R1053	1	0.145
35.0 ... 38.0/40.0	TF42-38	1SAZ721201R1055	1	0.145

Suitable for mounting on:

AF09 ... AF16

AF26 ... AF38

Functional description

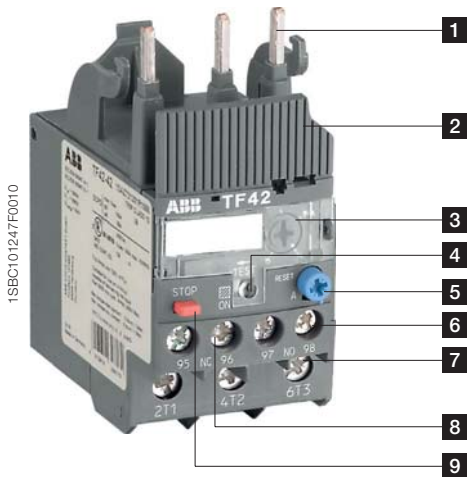

- 1** Terminals (1L1, 3L2, 5L3)
- 2** Sealable cover
- 3** Current setting range
Adjustable current setting for overload protection
- 4** Status indication
- 5** RESET button
Automatic or manual reset selectable
- 6** Signaling contacts 97-98
- 7** Terminals 2T1, 4T2, 6T3
- 8** Tripping contacts 95-96
- 9** STOP button

Application / internal function

The thermal overload relays are three pole relays with bimetal tripping elements (1 per pole). The motor current flows through the bimetal tripping elements and heats them directly and indirectly. In case of an overload (over current), the bimetal elements become bent as a result of the heating. This leads to a release of the relay and a change of the contacts switching position (95-96 / 97-98). The contact 95-96 is used to control the load contactor.

The overload relays have a setting scale in Amperes, which allows the direct adjusting of the relay without any additional calculation. In compliance with international and national standards, the setting current is the rated current of the motor and not the tripping current (no tripping at $1.05 \times I$, tripping at $1.2 \times I$; I = setting current). The relays are constructed in way that they protect themselves in the event of an overload. The overload relay has to be protected against short-circuit. The appropriate short-circuit protection devices are shown in the table.

Operation mode

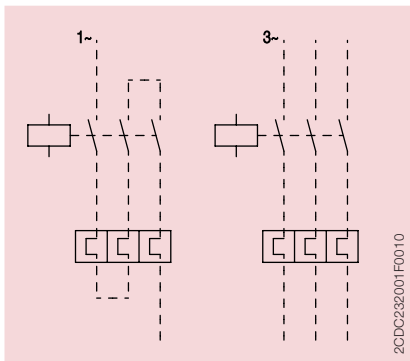

	Contact 95-96	Contact 97-98	Status indication	Comment
Trip state	open	closed		
RESET state	closed	open	ON	
TEST manual reset mode	open	closed		
TEST auto reset mode	open	closed		while TEST is operated
STOP while device is in trip state	open	closed		STOP button has no function
STOP while device is in RESET state	open	open		while STOP button is pressed

Wiring diagram

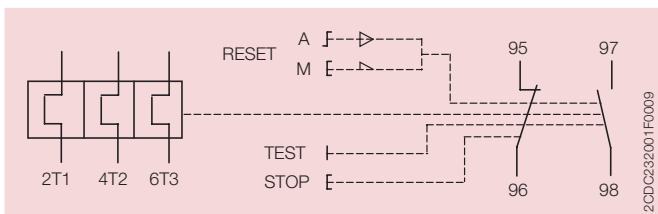

Resistance and power loss per pole and short-circuit protection device

Type	Setting range		Resistance per pole mΩ	Power loss		Short-circuit protection device coordination type 2
	lower value A	upper value A		at lower value W	at upper value W	
TF42-0.13	0.10	0.13	106508.88	1.1	2.0	0.5 A, Type T
TF42-0.17	0.13	0.17	62283.74	1.1	2.0	1.0 A, Type T
TF42-0.23	0.17	0.23	37429.00	1.1	2.0	1.0 A, Type T
TF42-0.31	0.23	0.31	20603.43	1.1	2.0	1.0 A, Type T
TF42-0.41	0.31	0.41	11421.77	1.1	2.0	2.0 A, Type gG
TF42-0.55	0.41	0.55	6347.11	1.1	2.0	2.0 A, Type gG
TF42-0.74	0.55	0.74	3615.62	1.1	2.0	4.0 A, Type gG
TF42-1.0	0.74	1.00	1920.00	1.1	2.0	6.0 A, Type gG
TF42-1.3	1.00	1.30	1065.09	1.1	2.0	6.0 A, Type gG
TF42-1.7	1.30	1.70	622.84	1.1	2.0	10.0 A, Type gG
TF42-2.3	1.70	2.30	340.26	1.1	2.0	10.0 A, Type gG
TF42-3.1	2.30	3.10	187.30	1.1	2.0	10.0 A, Type gG
TF42-4.2	3.10	4.20	102.04	1.1	2.0	20.0 A, Type gG
TF42-5.7	4.20	5.70	59.10	1.1	2.0	20.0 A, Type gG
TF42-7.6	5.70	7.60	31.16	1.1	2.0	35.0 A, Type gG
TF42-10	7.60	10.00	19.30	1.1	2.0	35.0 A, Type gG
TF42-13	10.00	13.00	13.07	1.3	2.2	40.0 A, Type gG
TF42-16	13.00	16.00	7.79	1.3	2.2	40.0 A, Type gG
TF42-20	16.00	20.00	6.25	1.8	2.6	63.0 A, Type gG
TF42-24	20.00	24.00	4.51	1.8	2.6	63.0 A, Type gG
TF42-29	24.00	29.00	3.09	1.8	2.6	63.0 A, Type gG
TF42-35	29.00	35.00	2.25	2.1	2.8	80.0 A, Type gG
TF42-38	35.00	40.00	1.72	2.1	2.8	80.0 A, Type gG

Technical diagrams

Intermittent periodic duty

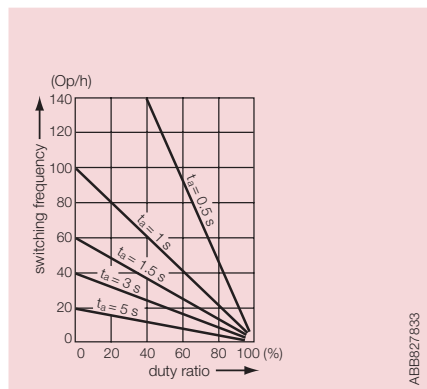

Motor starting time

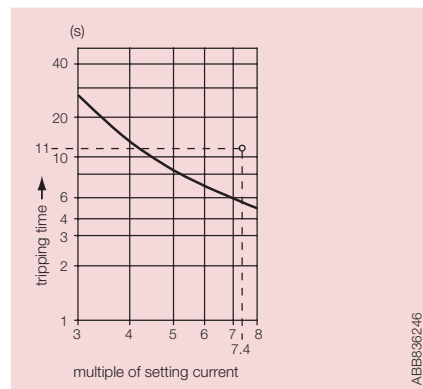

Tripping curve, starting from cold state

Dimensions

in mm and inches

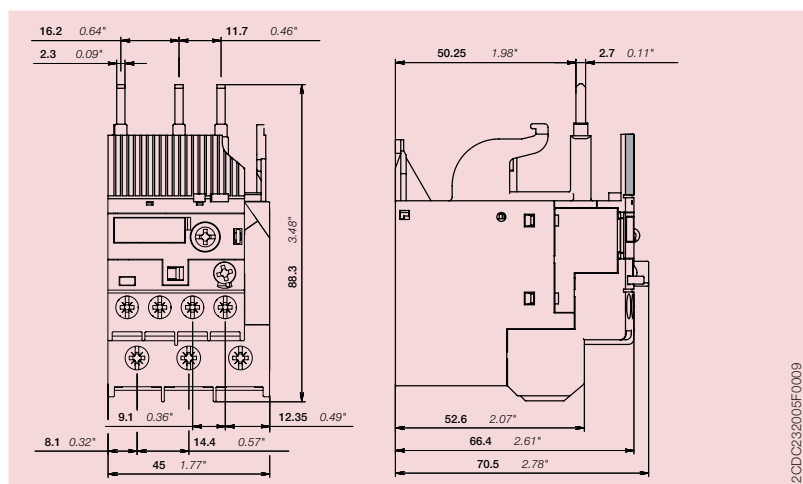

Technical data IEC/EN

Data at $T_A = 40\text{ °C}$ and at rated values, if nothing else indicated

Main circuit

		2T1-4T2-6T3	
Rated operational voltage U_e		690 V a.c. - V d.c.	
Setting range - thermal overload protection		see table on page 1	
Rated operational current AC-3 I_e		see upper value of setting range, table on page 3	
Trip class		10	
Rated frequency		50/60 Hz	
Number of poles		3	
Resistance per pole		see table on page 3	
Power loss per pole		see table on page 3	
Short-circuit protection device		see table on page 3	
Isolation data		2T1-4T2-6T3	
Rated impulse withstand voltage U_{imp}		6 kV	
Rated insulation voltage U_i		690 V	
Pollution degree		3	
Electrical connection		TF42 ≤ 20 A	TF42 > 20 A
Connecting capacity	solid	1/2 x 0.75 ... 4 mm ²	1/2 x 1.5 ... 2.5 mm ² / 1/2 x 2.5 ... 10 mm ²
	stranded	1/2 x 0.75 ... 4 mm ²	1/2 x 1.5 ... 2.5 mm ² / 1/2 x 2.5 ... 10 mm ²
	flexible with ferrule	1/2 x 0.75 ... 4 mm ²	1/2 x 1.5 ... 2.5 mm ² / 1/2 x 2.5 ... 10 mm ²
	flexible with ferrule isolated	1/2 x 0.75 ... 4 mm ²	1/2 x 1.5 ... 6 mm ²
	flexible without ferrule	1/2 x 0.75 ... 4 mm ²	1/2 x 2.5 ... 4 mm ² / 1/2 x 4 ... 6 mm ²
	Stripping length		12 mm
Tightening torque		1.5 ... 2.5 Nm	2.5 ... 2.7 Nm
Connection screw		M4 (Pozidrive 2)	

Auxiliary circuit

		95-96, 97-98
Rated operational voltage U_e		600 V
Conventional free air thermal current I_{th}	NC, 95-96	6 A
	NO, 97-98	4 A
Rated frequency		d.c., 50/60 Hz
Number of poles		1NC + 1NO
Rated operational current I_e		
acc. to IEC/EN 60947-5-1 for utilization category		
at AC15 at 110-120 V	NC, 95-96	3.00 A
	NO, 97-98	0.75 A
at AC15 at 220-230-240 V	NC, 95-96	3.00 A
	NO, 97-98	0.75 A
at AC15 at 440 V	NC, 95-96	0.75 A
	NO, 97-98	0.75 A
at AC15 at 480-500 V	NC, 95-96	0.75 A
	NO, 97-98	0.75 A
at DC13 at 24 V	NC, 95-96	1.25 A
	NO, 97-98	1.25 A
at DC13 at 110-120-125 V	NC, 95-96	0.55 A
	NO, 97-98	0.55 A
at DC13 at 250 V	NC, 95-96	0.27 A
	NO, 97-98	0.27 A
at DC13 at 500 V	NC, 95-96	0.15 A
	NO, 97-98	0.15 A
Minimum switching capacity		17 V / 3 mA
Short-circuit protection device	NC, 95-96	6 A, Type gG
	NO, 97-98	4 A, Type gG
Isolation data		95-96, 97-98
Rated impulse withstand voltage U_{imp}		6 kV
Rated insulation voltage U_i		690 V
Pollution degree		3
Electrical connection		95-96, 97-98
Connecting capacity	solid	1/2 x 0.75 ... 4 mm ²
	stranded	1/2 x 0.75 ... 4 mm ²
	flexible with ferrule	1/2 x 0.75 ... 2.5 mm ²
	flexible with ferrule isolated	1 x 0.75 ... 2.5 mm ²
		2 x 0.75 ... 1.5 mm ²
flexible without ferrule	1/2 x 0.75 ... 1 mm ² / 1/2 x 1 ... 2.5 mm ²	
Stripping length		9 mm
Tightening torque		1 ... 1.5 Nm
Connection screw		M3 (Pozidrive 2)

Generell data

Duty time		100 %
Operating frequency without early tripping		up to 15 operations/h or 60 operations/h with 40 % duty ratio, if the motor breaking current $6 \times I_n$ and the motor starting time does not exceed 1 s
Dimensions (W x H x D)		see dimension drawing
Weight		see ordering data
Mounting		mount on the contactor and tighten the screws of the main circuit terminals or with single mounting kit on DIN rail (35 mm)
Mounting position		position 1-5
Minimum distance to other units same type	horizontal	none
	vertical	not applicable
Minimum distance to electrical conductive board	horizontal	none
	vertical	on request
Degree of protection		IP20
Altitude		up to 2000 m

Electromagnetic compatibility

Electromagnetic compatibility		not applicable
-------------------------------	--	----------------

Environmental data

Ambient air temperature		
Operation	open - compensated without derating	-25 ... +60 °C (> 38 A: -25 ... +50 °C)
	open	-25 ... +60 °C (> 38 A: -25 ... +50 °C)
Storage		-50 ... +80 °C
Temperature compensation		continuous
Vibration (sinusoidal) acc. to IEC/EN 60068-2-6 (Fc)		5g / 3 ... 150 Hz
Shock (half-sine) acc. to IEC/EN 60068-2-27 (Ea)		25g / 11 ms

Standards / directives

Product standard		IEC/EN 60947-4-1
		IEC/EN 60497-5-1
		IEC/EN 60947-1
		UL 508, CSA22.2 No. 14
Low Voltage Directive		2006/95/EC
EMC Directive		2004/108/EC
RoHS Directive		2002/95/EC

Technical data UL/CSA

Full load amps and short-circuit protection device

Type	Full load amps (FLA)	Short-circuit protection device coordination type 2
	A	
TF42-0.13	0.13	1 A, Fuse type K5
TF42-0.17	0.17	1 A, Fuse type K5
TF42-0.23	0.23	1 A, Fuse type K5
TF42-0.31	0.31	3 A, Fuse type K5
TF42-0.41	0.41	3 A, Fuse type K5
TF42-0.55	0.55	3 A, Fuse type K5
TF42-0.74	0.74	3 A, Fuse type K5
TF42-1.0	1.00	6 A, Fuse type K5
TF42-1.3	1.30	6 A, Fuse type K5
TF42-1.7	1.70	6 A, Fuse type K5
TF42-2.3	2.30	10 A, Fuse type K5
TF42-3.1	3.10	10 A, Fuse type K5
TF42-4.2	4.20	15 A, Fuse type K5
TF42-5.7	5.70	20 A, Fuse type K5
TF42-7.6	7.60	25 A, Fuse type K5
TF42-10	10.00	35 A, Fuse type K5
TF42-13	13.00	40 A, Fuse type K5
TF42-16	16.00	60 A, Fuse type K5
TF42-20	20.00	80 A, Fuse type K5
TF42-24	24.00	80 A, Fuse type K5
TF42-29	29.00	100 A, Fuse type K5
TF42-35	35.00	150 A, Fuse type K5
TF42-38	40.00	150 A, Fuse type K5

Main circuit

Maximum operational voltage	600 V a.c.
Trip rating	125 % of FLA
Full load amps (FLA)	see table above
Short-circuit rating RMS at 600 V symmetrical	18000 A
Short-circuit protection device	see table above

Electrical connection		TF42 ≤ 20 A	TF42 > 20 A
		Connecting capacity	stranded
	flexible without ferrule	1/2 x AWG 18 ... 10	1/2 x AWG 14 ... 6
Stripping length		12 mm	
Tightening torque		13 ... 22 lb-in	22 lb-in

Auxiliary circuit

Conventional thermal current	NC	5 A
	NO	2.5 A
Making and breaking capacity	NC	B600, Q300
	NO	D300, Q300

Electrical connection		
Connecting capacity	stranded	1/2 x AWG 18 ... 12
	flexible without ferrule	1/2 x AWG 18 ... 12
Stripping length		9 mm
Tightening torque		9 ... 13 lb-in

Contact us

ABB STOTZ-KONTAKT GmbH

Eppelheimer Straße 82
69123 Heidelberg, Germany
Phone: +49 (0) 6221 7 01-0
Fax: +49 (0) 6221 7 01-13 25
E-Mail: info.desto@de.abb.com

You can find the address of your
local sales organisation on the
ABB home page
<http://www.abb.com/contacts>
-> Low Voltage Products and Systems

Note:

We reserve the right to make technical changes or modify the contents of this document without prior notice. With regard to purchase orders, the agreed particulars shall prevail. ABB AG does not accept any responsibility whatsoever for potential errors or possible lack of information in this document.

We reserve all rights in this document and in the subject matter and illustrations contained therein. Any reproduction, disclosure to third parties or utilization of its contents – in whole or in parts – is forbidden without prior written consent of ABB AG.

Copyright© 2010 ABB
All rights reserved