

LR Position Switches

- Technopolymer housing, one conduit entry
- Protection degree IP67 according to EN 60529
- 17 contact blocks available
- 48 actuators available
- M12 assembled connector versions
- Silver contacts gold plated versions
- Other versions available (see LM, LX, LZ datasheets)



Approvals



General data

Ambient temperature:	-25°C ... +80°C
Max. actuation frequency:	3600 operating cycles ¹ /hour
Mechanical endurance:	20 million operating cycles ¹
Mounting position:	any
Safety parameters:	
B _{10d} :	40,000,00 for NC contacts
Mechanical interlock, not coded:	type 1 according to EN ISO 14119

(1) One operation cycle means two movements, one to close and one to open contacts, as defined in EN 60947-5-1.

Cable cross section (flexible copper strands)

Contact blocks C20, C21, C22, C33, C34:	min. 1 x 0.34 mm ²	(1 x AWG 22)
	max. 2 x 1.5 mm ²	(2 x AWG 16)
Contact block C5, C6, C7, C9, C10, C11, C12, C13, C14, C15, C16, C18:	min. 1 x 0.5 mm ²	(1 x AWG 20)
	max. 2 x 2.5 mm ²	(2 x AWG 14)
Contact block C2:	min. 1 x 0.5 mm ²	(1 x AWG 20)
	max. 2 x 1.5 mm ²	(2 x AWG 16)

In conformity with standards:

IEC 60947-5-1, EN 60947-5-1, EN 60947-1, EN 50047, IEC 60204-1, EN 60204-1, EN ISO 14119, EN ISO 12100, IEC 60529, EN 60529, UL 508, CSA 22.2 No. 14 .

Approvals:

IEC 60947-5-1, UL 508, CSA 22.2 No.14, GB14048.5-2001.

In conformity with the requirements of:

Low Voltage Directive 2006/95/EC, Machinery Directive 2006/42/EC and EMC Directive 2004/108/EC.

Positive contact opening in conformity with standards:

IEC 60947-5-1, EN 60947-5-1.

Installation for safety applications:

Use only switches marked with the symbol ⊕ aside the product code. Always connect the safety circuit to the **NC contacts** (normally closed contacts: C11-C12, C21-C22 or C31-C32) as stated in **standard EN 60947-5-1, encl. K, par. 2**. Actuate the switch **at least up to the positive opening travel** shown in the travel diagrams. Operate the switch **at least with the positive opening force**, indicated between brackets below each article, aside the minimum force value.

Electrical data

Utilization category

without connector	Thermal current (I _{th}):	10 A	Alternating current: AC15 (50 ÷ 60 Hz)			
	Rated insulation voltage (U _i):	500 Vac 600 Vdc	Ue (V)	250	400	500
		400 Vac 500 Vdc (contact blocks 2, 11, 12, 20, 21, 22, 33, 34)	Ie (A)	6	4	1
	Rated impulse withstand voltage (U _{imp}):	6 kV	Direct current: DC13			
	4 kV (contact blocks 20, 21, 22, 33, 34)	Ue (V)	24	125	250	
Conditional short circuit current:	1000 A according to EN 60947-5-1	Ie (A)	6	1.1	0.4	
Protection against short circuits:	type aM fuse 10 A 500 V					
Pollution degree:	3					

with connector M12, 4 poles	Thermal current (I _{th}):	4 A	Alternating current: AC15 (50 ÷ 60 Hz)			
	Rated insulation voltage (U _i):	250 Vac 300 Vdc	Ue (V)	24	120	250
	Protection against short circuits:	type gG fuse 4 A 500 V	Ie (A)	4	4	4
	Pollution degree:	3	Direct current: DC13			
Ue (V)	24	125	250			
Ie (A)	4	1.1	0.4			

with connector M12, 8 poles	Thermal current (I _{th}):	2 A	Alternating current: AC15 (50 ÷ 60 Hz)		
	Rated insulation voltage (U _i):	30 Vac 36 Vdc	Ue (V)	24	
	Protection against short circuits:	type gG fuse 2 A 500 V	Ie (A)	2	
	Pollution degree:	3	Direct current: DC13		
Ue (V)	24				
Ie (A)	2				

Specifications

Rated insulation voltage (Ui): 500 Vac
 400 Vac (for contact blocks C2, C11, C12, C20, C21, C22, C33, C34)

Conventional free air thermal current (Ith): 10 A

Protection against short circuits: type aM fuse 10 A 500 V

Rated impulse withstand voltage (U_{imp}): 6 kV
 4 kV (for contact blocks C20, C21, C22, C33, C34)

Protection degree of the housing: IP67

MV terminals (screw terminals)

Pollution degree 3

Utilization category: AC15

Operating voltage (Ue): 400 Vac (50 Hz)

Operating current (Ie): 3 A

Forms of the contact element: Za, Zb, Za+Za, Y+Y, X+X, Y+Y+X, Y+Y+Y, Y+X+X

Positive opening of contacts on contact blocks C5, C6, C7, C9, C11, C13, C14, C16, C18, C20, C21, C22, C33, C34

In conformity with standards: EN 60947-1, EN 60947-5-1 + A1:2009, fundamental requirements of the Low Voltage Directive 2006/95/EC.

Please contact our technical service for the list of approved products.

UL Approval

Utilization categories Q300 (69 VA, 125 ... 250 Vdc)
 A600 (720 VA, 120 ... 600 Vac)

Data of housing type 1, 4X "indoor use only", 12, 13

For all contact blocks except C2 and C3 use 60 or 75°C copper (Cu) conductor, rigid or flexible, wire size AWG 12/14. Terminal tightening torque of 7.1 lb in (0.8 Nm).

For contact blocks C2 and C3 use 60 or 75 °C copper (Cu) conductor, rigid or flexible, wire size AWG 14. Terminal tightening torque of 12 lb in (1.4 Nm).

In conformity with standard: UL 508, CSA 22.2 No.14

Please contact our technical service for the list of approved products.

Connection diagram for M12 connectors

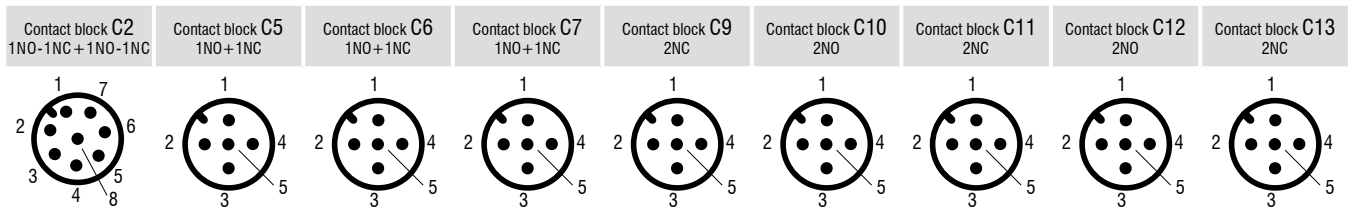

M12 connector, 8 poles M12 connector, 5 poles M12 connector, 5 poles M12 connector, 5 poles M12 connector, 5 poles M12 connector, 5 poles M12 connector, 5 poles M12 connector, 5 poles M12 connector, 5 poles

Contact block	Contacts	Pin no.	Contact block	Contacts	Pin no.	Contact block	Contacts	Pin no.	Contact block	Contacts	Pin no.	Contact block	Contacts	Pin no.	Contact block	Contacts	Pin no.	Contact block	Contacts	Pin no.						
C2	NO	3-4	C5	NC	1-2	C6	NC	1-2	C7	NC	1-2	C9	NC	1-2	C10	NO	1-2	C11	NC	1-2	C12	NO	1-2	C13	NC (1°)	1-2
	NC	5-6		NO	3-4		NO	3-4		NO	3-4		NC	3-4		NO	3-4		NC	3-4		NO	3-4		NC (2°)	3-4
	NC	7-8		ground	5		ground	5		ground	5		ground	5		ground	5		ground	5		ground	5		ground	5
	NO	1-2																								

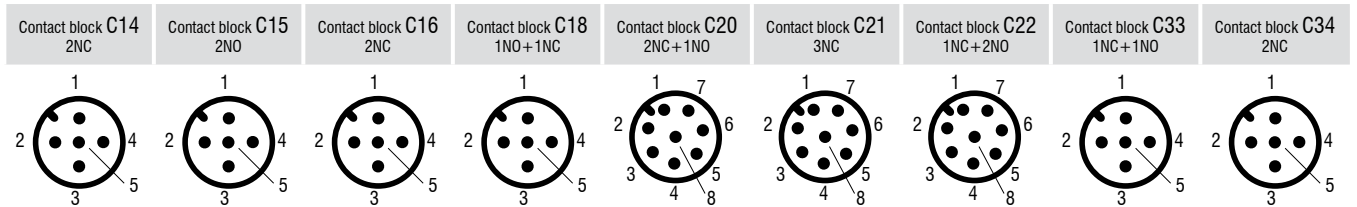

M12 connector, 5 poles M12 connector, 5 poles M12 connector, 5 poles M12 connector, 5 poles M12 connector, 8 poles M12 connector, 8 poles M12 connector, 8 poles M12 connector, 5 poles M12 connector, 5 poles

Contact block	Contacts	Pin no.	Contact block	Contacts	Pin no.	Contact block	Contacts	Pin no.	Contact block	Contacts	Pin no.	Contact block	Contacts	Pin no.	Contact block	Contacts	Pin no.	Contact block	Contacts	Pin no.	Contact block	Contacts	Pin no.	Contact block	Contacts	Pin no.
C14	NC (1°)	1-2	C15	NO (1°)	1-2	C16	NC, lever at the right	1-2	C18	NC	1-2	C20	NC	3-4	C21	NC	3-4	C22	NC	3-4	C33	NC	1-2	C34	NC	1-2
	NC (2°)	3-4		NO (2°)	3-4		NC, lever to the left	3-4		NO	3-4		NC	5-6		NC	5-6		NO	5-6		NO	3-4		NC	3-4
	ground	5		ground	5		ground	5		ground	5		NO	7-8		NC	7-8		NO	7-8		ground	5		ground	5
										ground	1		ground	1		ground	1		ground	1						

Contact block CE1
PNP

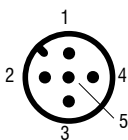

M12 connector, 5 poles

Contacts	Pin no.
+	1
-	3
NC	2
NO	4
ground	5

Selection diagram

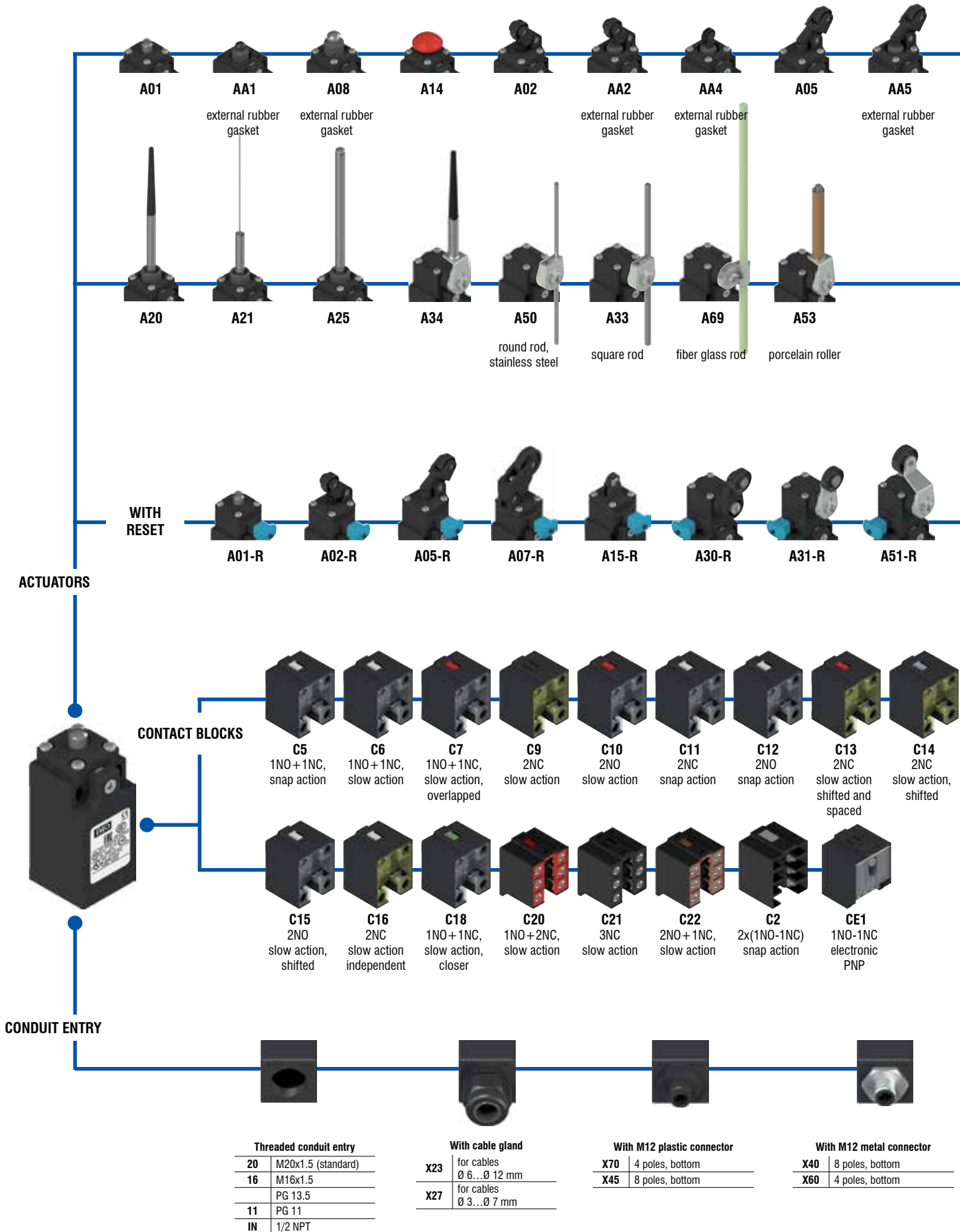

● product options
→ accessory sold separately

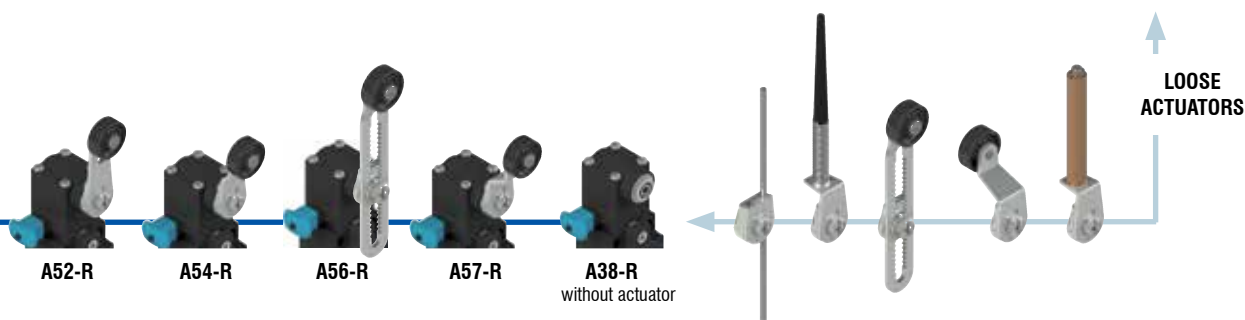
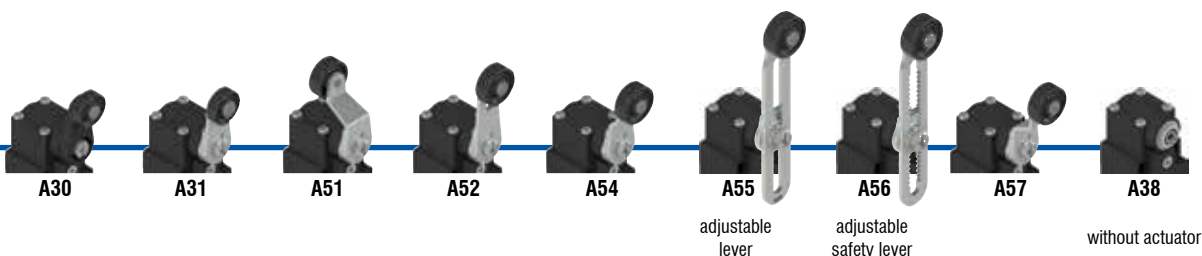
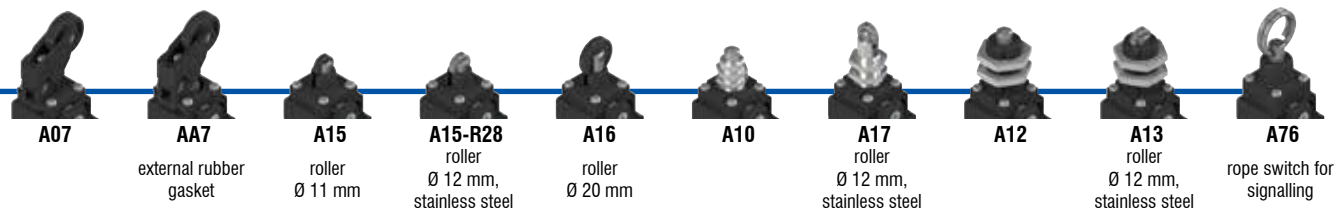

Options & Ordering Codes

Attention! The feasibility of a code number does not mean the effective availability of a product. Please contact our sales office.

	LR	C5	A02	-	1	R	SS	20	X70	
Housing	polymer, one conduit entry									Preinstalled Cable Gland or Connectors
	LR									no cable gland or connector (standard)
Contact Blocks										X21 assembled cable gland
1NO+1NC, snap action		C5								X70 4 poles M12 assembled plastic connector
1NO+1NC, slow action		C6								
1NO+1NC, slow action, overlapped		C7								
.....		...								
Other contact blocks available upon request										Threaded Conduit Entry
Actuators										PG 13.5 (standard)
short plunger			A01							11 PG 11
roller lever			A02							16 M16 x 1.5
offset roller lever			A05							20 M20 x 1.5
Other actuators available upon request										IN 1/2 NPT
Suffix										External Metallic Parts
no suffix (standard)										zinc plated steel (standard)
with stainless steel roller: - Ø 12mm for actuators AA4, A15 - Ø 14mm for actuators A2, A02, A5, A05 - Ø 20mm for actuators A30, A31, A51, A52, A54, A55, A56, A57					1					SS stainless steel
with Ø 35mm polymer roller					2					Reset Hooking
with Ø 50mm rubber roller					3					without reset (standard)
with Ø 50mm overhanging rubber roller					4					R simultaneous reset
										RI simultaneous reset with increased force

Contact type:

- R** = snap action
- L** = slow action
- LO** = slow action overlapped
- LS** = slow action shifted
- LV** = slow action shifted and spaced
- LI** = slow action independent
- LA** = slow action closer
- △** = electronic PNP

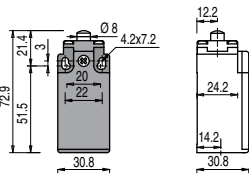

With external rubber gasket

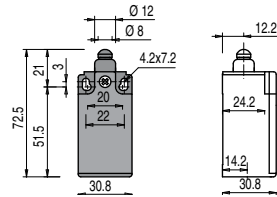

With stainless steel roller on request

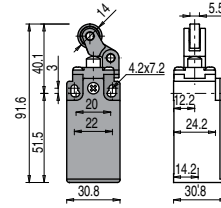

With external rubber gasket

With stainless steel roller on request

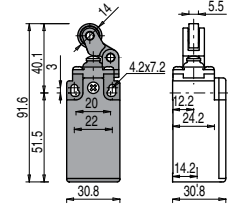

Contact blocks

C5	R	LRC5A01	⊕ 1NO+1NC	LRC5AA1	⊖ 1NO+1NC	LRC5A02	⊕ 1NO+1NC	LRC5AA2	⊕ 1NO+1NC
C6	L	LRC6A01	⊕ 1NO+1NC	LRC6AA1	⊕ 1NO+1NC	LRC6A02	⊕ 1NO+1NC	LRC6AA2	⊕ 1NO+1NC
C7	LO	LRC7A01	⊕ 1NO+1NC	LRC7AA1	⊕ 1NO+1NC	LRC7A02	⊕ 1NO+1NC	LRC7AA2	⊕ 1NO+1NC
C9	L	LRC9A01	⊕ 2NC	LRC9AA1	⊕ 2NC	LRC9A02	⊕ 2NC	LRC9AA2	⊕ 2NC
C10	L	LRC10A01	2NO	LRC10AA1	2NO	LRC10A02	2NO	LRC10AA2	2NO
C11	R	LRC11A01	⊕ 2NC	LRC11AA1	⊕ 2NC	LRC11A02	⊕ 2NC	LRC11AA2	⊕ 2NC
C12	R	LRC12A01	2NO	LRC12AA1	2NO	LRC12A02	2NO	LRC12AA2	2NO
C13	LV	LRC13A01	⊕ 2NC	LRC13AA1	⊕ 2NC	LRC13A02	⊕ 2NC	LRC13AA2	⊕ 2NC
C14	LS	LRC14A01	⊕ 2NC	LRC14AA1	⊕ 2NC	LRC14A02	⊕ 2NC	LRC14AA2	⊕ 2NC
C15	LS	LRC15A01	2NO	LRC15AA1	2NO	LRC15A02	2NO	LRC15AA2	2NO
C18	LA	LRC18A01	⊕ 1NO+1NC	LRC18AA1	⊖ 1NO+1NC	LRC18A02	⊕ 1NO+1NC	LRC18AA2	⊕ 1NO+1NC
C20	L	LRC20A01	⊕ 1NO+2NC	LRC20AA1	⊖ 1NO+2NC	LRC20A02	⊕ 1NO+2NC	LRC20AA2	⊕ 1NO+2NC
C21	L	LRC21A01	⊕ 3NC	LRC21AA1	⊖ 3NC	LRC21A02	⊕ 3NC	LRC21AA2	⊕ 3NC
C22	L	LRC22A01	⊕ 2NO+1NC	LRC22AA1	⊖ 2NO+1NC	LRC22A02	⊕ 2NO+1NC	LRC22AA2	⊕ 2NO+1NC
C2	R	LRC2A01	2x(1NO-1NC)	LRC2A01	2x(1NO-1NC)	LRC2A02	2x(1NO-1NC)	LRC2A02	2x(1NO-1NC)
CE1	△	LRCE1A01	1NO-1NC	LRCE1AA1	1NO-1NC	LRCE1A02	1NO-1NC	LRCE1AA2	1NO-1NC
Max. speed		Type 4		Type 4		Type 3		Type 3	
Min. force		8 N (25 N ⊕)		6 N (25 N ⊕)		6 N (25 N ⊕)		4.3 N (25 N ⊕)	
Travel diagrams		Group 1		Group 1		Group 2		Group 2	

With external rubber gasket

With Ø 12 mm stainless steel roller on request

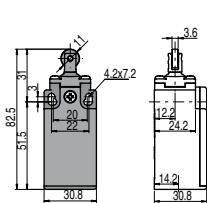

With stainless steel roller on request

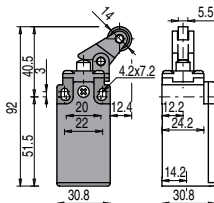

With external rubber gasket

With stainless steel roller on request

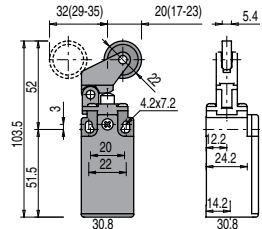
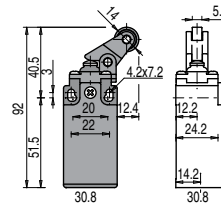

Contact blocks

C5	R	LRC5AA4	⊕ 1NO+1NC	LRC5A05	⊖ 1NO+1NC	LRC5AA5	⊕ 1NO+1NC	LRC5A07	⊕ 1NO+1NC
C6	L	LRC6AA4	⊕ 1NO+1NC	LRC6A05	⊕ 1NO+1NC	LRC6AA5	⊕ 1NO+1NC	LRC6A07	⊕ 1NO+1NC
C7	LO	LRC7AA4	⊕ 1NO+1NC	LRC7A05	⊕ 1NO+1NC	LRC7AA5	⊕ 1NO+1NC	LRC7A07	⊕ 1NO+1NC
C9	L	LRC9AA4	⊕ 2NC	LRC9A05	⊕ 2NC	LRC9AA5	⊕ 2NC	LRC9A07	⊕ 2NC
C10	L	LRC10AA4	2NO	LRC10A05	2NO	LRC10AA5	2NO	LRC10A07	2NO
C11	R	LRC11AA4	⊕ 2NC	LRC11A05	⊕ 2NC	LRC11AA5	⊕ 2NC	LRC11A07	⊕ 2NC
C12	R	LRC12AA4	2NO	LRC12A05	2NO	LRC12AA5	2NO	LRC12A07	2NO
C13	LV	LRC13AA4	⊕ 2NC	LRC13A05	⊕ 2NC	LRC13AA5	⊕ 2NC	LRC13A07	⊕ 2NC
C14	LS	LRC14AA4	⊕ 2NC	LRC14A05	⊕ 2NC	LRC14AA5	⊕ 2NC	LRC14A07	⊕ 2NC
C15	LS	LRC15AA4	2NO	LRC15A05	2NO	LRC15AA5	2NO	LRC15A07	2NO
C18	LA	LRC18AA4	⊕ 1NO+1NC	LRC18A05	⊖ 1NO+1NC	LRC18AA5	⊕ 1NO+1NC	LRC18A07	⊕ 1NO+1NC
C20	L	LRC20AA4	⊕ 1NO+2NC	LRC20A05	⊖ 1NO+2NC	LRC20AA5	⊕ 1NO+2NC	LRC20A07	⊕ 1NO+2NC
C21	L	LRC21AA4	⊕ 3NC	LRC21A05	⊖ 3NC	LRC21AA5	⊕ 3NC	LRC21A07	⊕ 3NC
C22	L	LRC22AA4	⊕ 2NO+1NC	LRC22A05	⊖ 2NO+1NC	LRC22AA5	⊕ 2NO+1NC	LRC22A07	⊕ 2NO+1NC
C2	R	LRC2A05	2x(1NO-1NC)	LRC2A05	2x(1NO-1NC)	LRC2AA5	2x(1NO-1NC)	LRC2A07	2x(1NO-1NC)
CE1	△	LRCE1AA4	1NO-1NC	LRCE1A05	1NO-1NC	LRCE1AA5	1NO-1NC	LRCE1A07	1NO-1NC
Max. speed		Type 5		Type 3		Type 3		Type 3	
Min. force		6 N (25 N ⊕)		6 N (25 N ⊕)		4.3 N (25 N ⊕)		4 N (25 N ⊕)	
Travel diagrams		Group 1		Group 2		Group 2		Group 3	

All measures in the drawings are in mm

Contact type:

- R** = snap action
- L** = slow action
- LO** = slow action overlapped
- LS** = slow action shifted
- LV** = slow action shifted and spaced
- LI** = slow action independent
- LA** = slow action closer
- = electronic PNP

Contact blocks

	With external rubber gasket		With external rubber gasket		Fixed only by threaded head in vertical position			
C5	R LRC5AA7	➔ 1NO+1NC	R LRC5A08	➔ 1NO+1NC	R LRC5A10	➔ 1NO+1NC	R LRC5A12	➔ 1NO+1NC
C6	L LRC6AA7	➔ 1NO+1NC	L LRC6A08	➔ 1NO+1NC	L LRC6A10	➔ 1NO+1NC	L LRC6A12	➔ 1NO+1NC
C7	LO LRC7AA7	➔ 1NO+1NC	LO LRC7A08	➔ 1NO+1NC	LO LRC7A10	➔ 1NO+1NC	LO LRC7A12	➔ 1NO+1NC
C9	L LRC9AA7	➔ 2NC	L LRC9A08	➔ 2NC	L LRC9A10	➔ 2NC	L LRC9A12	➔ 2NC
C10	L LRC10AA7	2NO	L LRC10A08	2NO	L LRC10A10	2NO	L LRC10A12	2NO
C11	R LRC11AA7	➔ 2NC	R LRC11A08	➔ 2NC	R LRC11A10	➔ 2NC	R LRC11A12	➔ 2NC
C12	R LRC12AA7	2NO	R LRC12A08	2NO	R LRC12A10	2NO	R LRC12A12	2NO
C13	LV LRC13AA7	➔ 2NC	LV LRC13A08	➔ 2NC	LV LRC13A10	➔ 2NC	LV LRC13A12	➔ 2NC
C14	LS LRC14AA7	➔ 2NC	LS LRC14A08	➔ 2NC	LS LRC14A10	➔ 2NC	LS LRC14A12	➔ 2NC
C15	LS LRC15AA7	2NO	LS LRC15A08	2NO	LS LRC15A10	2NO	LS LRC15A12	2NO
C18	LA LRC18AA7	➔ 1NO+1NC	LA LRC18A08	➔ 1NO+1NC	LA LRC18A10	➔ 1NO+1NC	LA LRC18A12	➔ 1NO+1NC
C20	L LRC20AA7	➔ 1NO+2NC	L LRC20A08	➔ 1NO+2NC	L LRC20A10	➔ 1NO+2NC	L LRC20A12	➔ 1NO+2NC
C21	L LRC21AA7	➔ 3NC	L LRC21A08	➔ 3NC	L LRC21A10	➔ 3NC	L LRC21A12	➔ 3NC
C22	L LRC22AA7	➔ 2NO+1NC	L LRC22A08	➔ 2NO+1NC	L LRC22A10	➔ 2NO+1NC	L LRC22A12	➔ 2NO+1NC
C2	R LRC2AA7	2x(1NO-1NC)	R LRC2A08	2x(1NO-1NC)	R LRC2A10	2x(1NO-1NC)	R LRC2A12	2x(1NO-1NC)
CE1	LRCE1AA7	1NO-1NC	LRCE1A08	1NO-1NC	LRCE1A10	1NO-1NC	LRCE1A12	1NO-1NC
Max. speed	Type 3		Type 4		Type 4		Type 4	
Min. force	3 N (25 N ➔)		8 N (25 N ➔)		8 N (25 N ➔)		8 N (25 N ➔)	
Travel diagrams	Group 3		Group 1		Group 1		Group 1	

	Roller, Ø 11 mm, technopolymer		Roller, Ø 12 mm, stainless steel	
C5	R LRC5A13	➔ 1NO+1NC	R LRC5A15	➔ 1NO+1NC
C6	L LRC6A13	➔ 1NO+1NC	L LRC6A15	➔ 1NO+1NC
C7	LO LRC7A13	➔ 1NO+1NC	LO LRC7A15	➔ 1NO+1NC
C9	L LRC9A13	➔ 2NC	L LRC9A15	➔ 2NC
C10	L LRC10A13	2NO	L LRC10A15	2NO
C11	R LRC11A13	➔ 2NC	R LRC11A15	➔ 2NC
C12	R LRC12A13	2NO	R LRC12A15	2NO
C13	LV LRC13A13	➔ 2NC	LV LRC13A15	➔ 2NC
C14	LS LRC14A13	➔ 2NC	LS LRC14A15	➔ 2NC
C15	LS LRC15A13	2NO	LS LRC15A15	2NO
C18	LA LRC18A13	➔ 1NO+1NC	LA LRC18A15	➔ 1NO+1NC
C20	L LRC20A13	➔ 1NO+2NC	L LRC20A15	➔ 1NO+2NC
C21	L LRC21A13	➔ 3NC	L LRC21A15	➔ 3NC
C22	L LRC22A13	➔ 2NO+1NC	L LRC22A15	➔ 2NO+1NC
C2	R LRC2A13	2x(1NO-1NC)	R LRC2A15	2x(1NO-1NC)
CE1	LRCE1A13	1NO-1NC	LRCE1A15	1NO-1NC
Max. speed	Type 2		Type 2	
Min. force	8 N (25 N ➔)		8 N (25 N ➔)	
Travel diagrams	Group 1		Group 1	

All measures in the drawings are in mm

Contact type:

- R** = snap action
- L** = slow action
- LO** = slow action overlapped
- LS** = slow action shifted
- LV** = slow action shifted and spaced
- LI** = slow action independent
- LA** = slow action closer
- △** = electronic PNP

Contact blocks

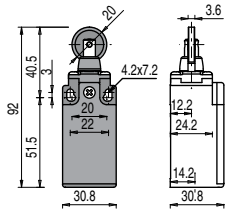

Fixed only by threaded head in vertical position

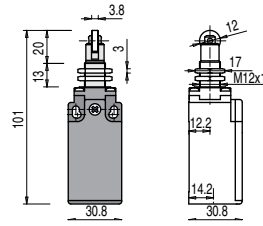

With external rubber gasket

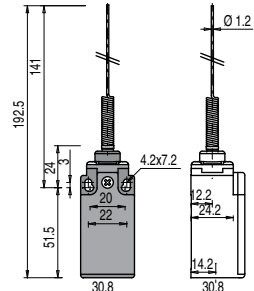
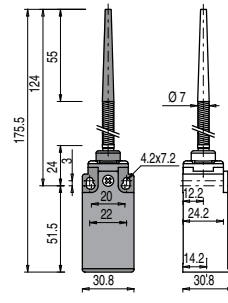

C5	R	LRC5A16-20	⊕ 1NO+1NC	LRC5A17-20	⊖ 1NO+1NC	LRC5A20-20	1NO+1NC	LRC5A21-20	1NO+1NC
C6	L	LRC6A16-20	⊕ 1NO+1NC	LRC6A17-20	⊕ 1NO+1NC				
C7	LO	LRC7A16-20	⊕ 1NO+1NC	LRC7A17-20	⊕ 1NO+1NC				
C9	L	LRC9A16-20	⊕ 2NC	LRC9A17-20	⊕ 2NC				
C10	L	LRC10A16-20	2NO	LRC10A17-20	2NO	LRC10A20-20	2NO	LRC10A21-20	2NO
C11	R	LRC11A16-20	⊕ 2NC	LRC11A17-20	⊕ 2NC				
C12	R	LRC12A16-20	2NO	LRC12A17-20	2NO	LRC12A20-20	2NO	LRC12A21-20	2NO
C13	LV	LRC13A16-20	⊕ 2NC	LRC13A17-20	⊕ 2NC				
C14	LS	LRC14A16-20	⊕ 2NC	LRC14A17-20	⊕ 2NC				
C15	LS	LRC15A16-20	2NO	LRC15A17-20	2NO				
C18	LA	LRC18A16-20	⊕ 1NO+1NC	LRC18A17-20	⊕ 1NO+1NC	LRC18A20-20	1NO+1NC	LRC18A21-20	1NO+1NC
C20	L	LRC20A16-20	⊕ 1NO+2NC	LRC20A17-20	⊕ 1NO+2NC	LRC20A20-20	1NO+2NC	LRC20A21-20	1NO+2NC
C21	L	LRC21A16-20	⊕ 3NC	LRC21A17-20	⊕ 3NC	LRC21A20-20	3NC	LRC21A21-20	3NC
C22	L	LRC22A16-20	⊕ 2NO+1NC	LRC22A17-20	⊕ 2NO+1NC	LRC22A20-20	2NO+1NC	LRC22A21-20	2NO+1NC
C2	R	LRC2A16-20	2x(1NO-1NC)	LRC2A17-20	2x(1NO-1NC)	LRC2A20-20	2x(1NO-1NC)	LRC2A21-20	2x(1NO-1NC)
CE1	△	LRCE1A16-20	1NO-1NC	LRCE1A17-20	1NO-1NC	LRCE1A20-20	1NO-1NC	LRCE1A21-20	1NO-1NC
Max. speed		Type 2		Type 2		1 m/s		1 m/s	
Min. force		8 N (25 N ⊕)		8 N (25 N ⊕)		0.07 Nm		0.07 Nm	
Travel diagrams		Group 1		Group 1		Group 4		Group 4	

With external rubber gasket

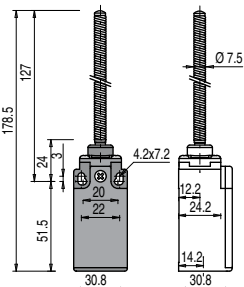

With Ø 20 mm stainless steel roller on request

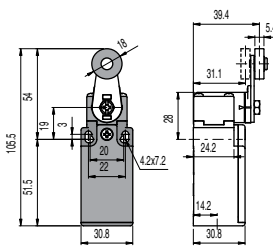
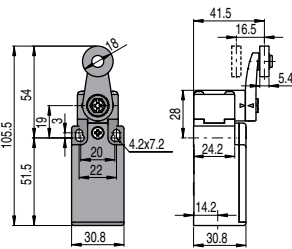

Square rod, 3x3 mm

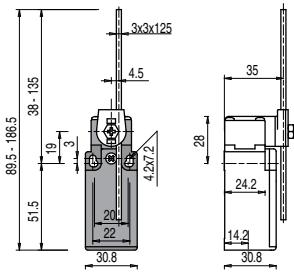

Contact blocks

C5	R	LRC5A25-20	1NO+1NC	LRC5A30-20	⊖ 1NO+1NC	LRC5A31-20	⊕ 1NO+1NC	LRC5A33-20	1NO+1NC
C6	L			LRC6A30-20	⊕ 1NO+1NC	LRC6A31-20	⊕ 1NO+1NC	LRC6A33-20	1NO+1NC
C7	LO			LRC7A30-20	⊕ 1NO+1NC	LRC7A31-20	⊕ 1NO+1NC	LRC7A33-20	1NO+1NC
C9	L			LRC9A30-20	⊕ 2NC	LRC9A31-20	⊕ 2NC	LRC9A33-20	2NC
C10	L	LRC10A25-20	2NO	LRC10A30-20	2NO	LRC10A31-20	2NO	LRC10A33-20	2NO
C11	R			LRC11A30-20	⊕ 2NC	LRC11A31-20	⊕ 2NC	LRC11A33-20	2NC
C12	R	LRC12A25-20	2NO	LRC12A30-20	2NO	LRC12A31-20	2NO	LRC12A33-20	2NO
C13	LV			LRC13A30-20	⊕ 2NC	LRC13A31-20	⊕ 2NC	LRC13A33-20	2NC
C14	LS			LRC14A30-20	⊕ 2NC	LRC14A31-20	⊕ 2NC	LRC14A33-20	2NC
C15	LS			LRC15A30-20	2NO	LRC15A31-20	2NO	LRC15A33-20	2NO
C16	LI			LRC16A30-20	⊕ 2NC	LRC16A31-20	⊕ 2NC	LRC16A33-20	2NC
C18	LA	LRC18A25-20	1NO+1NC	LRC18A30-20	⊕ 1NO+1NC	LRC18A31-20	⊕ 1NO+1NC	LRC18A33-20	1NO+1NC
C20	L	LRC20A25-20	1NO+2NC	LRC20A30-20	⊕ 1NO+2NC	LRC20A31-20	⊕ 1NO+2NC	LRC20A33-20	1NO+2NC
C21	L	LRC21A25-20	3NC	LRC21A30-20	⊕ 3NC	LRC21A31-20	⊕ 3NC	LRC21A33-20	3NC
C22	L	LRC22A25-20	2NO+1NC	LRC22A30-20	⊕ 2NO+1NC	LRC22A31-20	⊕ 2NO+1NC	LRC22A33-20	2NO+1NC
C2	R	LRC2A25-20	2x(1NO-1NC)	LRC2A30-20	2x(1NO-1NC)	LRC2A31-20	2x(1NO-1NC)	LRC2A33-20	2x(1NO-1NC)
CE1	△	LRCE1A25-20	1NO-1NC	LRCE1A30-20	1NO-1NC	LRCE1A31-20	1NO-1NC	LRCE1A33-20	1NO-1NC
Max. speed		1 m/s		Type 1		Type 1		1.5 m/s	
Min. force		0.12 Nm		0.06 Nm (0.25 Nm ⊕)		0.06 Nm (0.25 Nm ⊕)		0.06 Nm	
Travel diagrams		Group 4		Group 5		Group 5		Group 5	

All measures in the drawings are in mm

Contact type:

- R** = snap action
- L** = slow action
- LO** = slow action overlapped
- LS** = slow action shifted
- LV** = slow action shifted and spaced
- LI** = slow action independent
- LA** = slow action closer
- = electronic PNP

Contact blocks

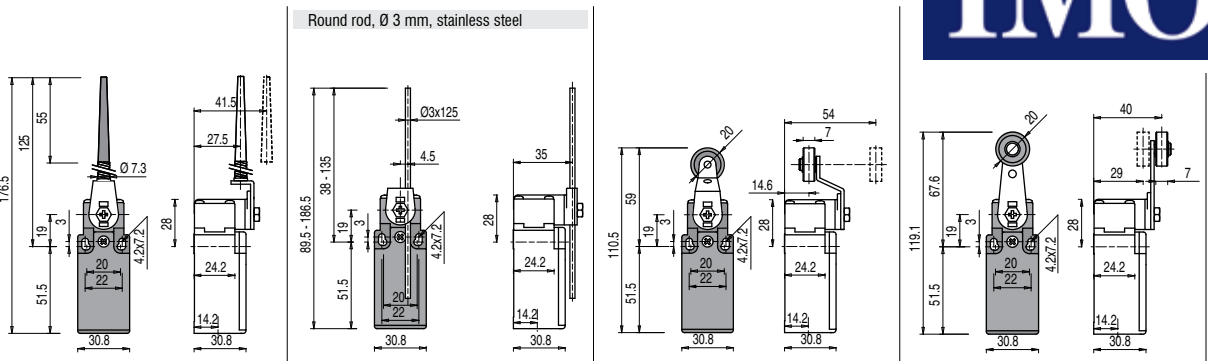

C5	R	LRC5A34-20	1NO+1NC	LRC5A50-20	1NO+1NC	LRC5A51-20	⊕ 1NO+1NC	LRC5A52-20	⊕ 1NO+1NC
C6	L	LRC6A34-20	1NO+1NC	LRC6A50-20	1NO+1NC	LRC6A51-20	⊕ 1NO+1NC	LRC6A52-20	⊕ 1NO+1NC
C7	LO	LRC7A34-20	1NO+1NC	LRC7A50-20	1NO+1NC	LRC7A51-20	⊕ 1NO+1NC	LRC7A52-20	⊕ 1NO+1NC
C9	L	LRC9A34-20	2NC	LRC9A50-20	2NC	LRC9A51-20	⊕ 2NC	LRC9A52-20	⊕ 2NC
C10	L	LRC10A34-20	2NO	LRC10A50-20	2NO	LRC10A51-20	2NO	LRC10A52-20	2NO
C11	R	LRC11A34-20	2NC	LRC11A50-20	2NC	LRC11A51-20	⊕ 2NC	LRC11A52-20	⊕ 2NC
C12	R	LRC12A34-20	2NO	LRC12A50-20	2NO	LRC12A51-20	2NO	LRC12A52-20	2NO
C13	LV	LRC13A34-20	2NC	LRC13A50-20	2NC	LRC13A51-20	⊕ 2NC	LRC13A52-20	⊕ 2NC
C14	LS	LRC14A34-20	2NC	LRC14A50-20	2NC	LRC14A51-20	⊕ 2NC	LRC14A52-20	⊕ 2NC
C15	LS	LRC15A34-20	2NO	LRC15A50-20	2NO	LRC15A51-20	2NO	LRC15A52-20	2NO
C16	LI	LRC16A34-20	2NC	LRC16A50-20	2NC	LRC16A51-20	⊕ 2NC	LRC16A52-20	⊕ 2NC
C18	LA	LRC18A34-20	1NO+1NC	LRC18A50-20	1NO+1NC	LRC18A51-20	⊕ 1NO+1NC	LRC18A52-20	⊕ 1NO+1NC
C20	L	LRC20A34-20	1NO+2NC	LRC20A50-20	1NO+2NC	LRC20A51-20	⊕ 1NO+2NC	LRC20A52-20	⊕ 1NO+2NC
C21	L	LRC21A34-20	3NC	LRC21A50-20	3NC	LRC21A51-20	⊕ 3NC	LRC21A52-20	⊕ 3NC
C22	L	LRC22A34-20	2NO+1NC	LRC22A50-20	2NO+1NC	LRC22A51-20	⊕ 2NO+1NC	LRC22A52-20	⊕ 2NO+1NC
C2	R	LRC2A34-20	2x(1NO-1NC)	LRC2A50-20	2x(1NO-1NC)	LRC2A51-20	2x(1NO-1NC)	LRC2A52-20	2x(1NO-1NC)
CE1		LRCE1A34-20	1NO-1NC	LRCE1A50-20	1NO-1NC	LRCE1A51-20	1NO-1NC	LRCE1A52-20	1NO-1NC
Max. speed		1.5 m/s		1.5 m/s		Type 1		Type 1	
Min. force		0.06 Nm		0.06 Nm		0.06 Nm (0.25 Nm ⊕)		0.06 Nm (0.25 Nm ⊕)	
Travel diagrams		Group 5		Group 5		Group 5		Group 5	

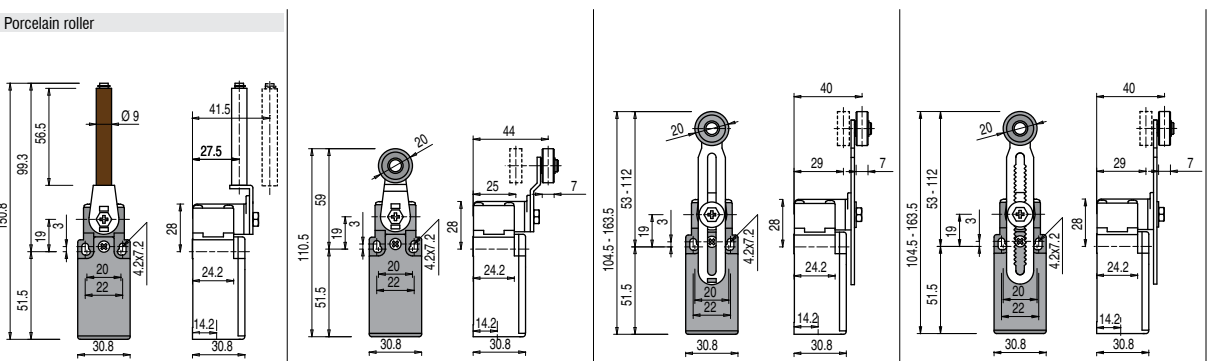

Contact blocks

C5	R	LRC5A53-20	⊕ 1NO+1NC	LRC5A54-20	⊕ 1NO+1NC	LRC5A55-20	⊕ (*) 1NO+1NC	LRC5A56-20	⊕ 1NO+1NC
C6	L	LRC6A53-20	⊕ 1NO+1NC	LRC6A54-20	⊕ 1NO+1NC	LRC6A55-20	⊕ (*) 1NO+1NC	LRC6A56-20	⊕ 1NO+1NC
C7	LO	LRC7A53-20	⊕ 1NO+1NC	LRC7A54-20	⊕ 1NO+1NC	LRC7A55-20	⊕ (*) 1NO+1NC	LRC7A56-20	⊕ 1NO+1NC
C9	L	LRC9A53-20	⊕ 2NC	LRC9A54-20	⊕ 2NC	LRC9A55-20	⊕ (*) 2NC	LRC9A56-20	⊕ 2NC
C10	L	LRC10A53-20	2NO	LRC10A54-20	2NO	LRC10A55-20	2NO	LRC10A56-20	2NO
C11	R	LRC11A53-20	⊕ 2NC	LRC11A54-20	⊕ 2NC	LRC11A55-20	⊕ (*) 2NC	LRC11A56-20	⊕ 2NC
C12	R	LRC12A53-20	2NO	LRC12A54-20	2NO	LRC12A55-20	2NO	LRC12A56-20	2NO
C13	LV	LRC13A53-20	⊕ 2NC	LRC13A54-20	⊕ 2NC	LRC13A55-20	⊕ (*) 2NC	LRC13A56-20	⊕ 2NC
C14	LS	LRC14A53-20	⊕ 2NC	LRC14A54-20	⊕ 2NC	LRC14A55-20	⊕ (*) 2NC	LRC14A56-20	⊕ 2NC
C15	LS	LRC15A53-20	2NO	LRC15A54-20	2NO	LRC15A55-20	2NO	LRC15A56-20	2NO
C16	LI	LRC16A53-20	⊕ 2NC	LRC16A54-20	⊕ 2NC	LRC16A55-20	⊕ (*) 2NC	LRC16A56-20	⊕ 2NC
C18	LA	LRC18A53-20	⊕ 1NO+1NC	LRC18A54-20	⊕ 1NO+1NC	LRC18A55-20	⊕ (*) 1NO+1NC	LRC18A56-20	⊕ 1NO+1NC
C20	L	LRC20A53-20	⊕ 1NO+2NC	LRC20A54-20	⊕ 1NO+2NC	LRC20A55-20	⊕ (*) 1NO+2NC	LRC20A56-20	⊕ 1NO+2NC
C21	L	LRC21A53-20	⊕ 3NC	LRC21A54-20	⊕ 3NC	LRC21A55-20	⊕ (*) 3NC	LRC21A56-20	⊕ 3NC
C22	L	LRC22A53-20	⊕ 2NO+1NC	LRC22A54-20	⊕ 2NO+1NC	LRC22A55-20	⊕ (*) 2NO+1NC	LRC22A56-20	⊕ 2NO+1NC
C2	R	LRC2A53-20	2x(1NO-1NC)	LRC2A54-20	2x(1NO-1NC)	LRC2A55-20	2x(1NO-1NC)	LRC2A56-20	2x(1NO-1NC)
CE1		LRCE1A53-20	1NO-1NC	LRCE1A54-20	1NO-1NC	LRCE1A55-20	1NO-1NC	LRCE1A56-20	1NO-1NC
Max. speed		0.5 m/s		Type 1		Type 1		Type 1	
Min. force		0.03 Nm (0.25 Nm ⊕)		0.06 Nm (0.25 Nm ⊕)		0.06 Nm (0.25 Nm ⊕)		0.06 Nm (0.25 Nm ⊕)	
Travel diagrams		Group 6		Group 5		Group 5		Group 5	

(*) Positive opening only with actuator set to max.

All measures in the drawings are in mm

Contact type:

- R** = snap action
- L** = slow action

With Ø 12 mm stainless steel roller on request

With Ø 20 mm stainless steel roller on request

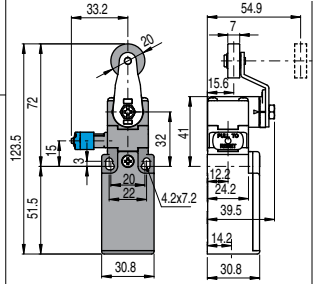
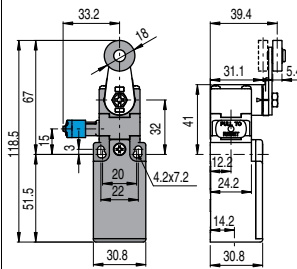
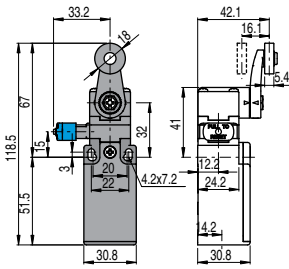
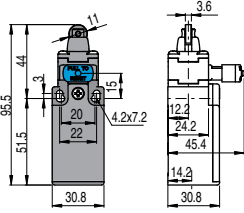

Contact blocks

C6	<input type="checkbox"/> L				
C9	<input type="checkbox"/> L	LRC9A15-R20	⊖ 2NC	LRC9A30-R20	⊕ 2NC
C10	<input type="checkbox"/> L				
C20	<input type="checkbox"/> L	LRC20A15-R20	⊖ 1NO+2NC	LRC20A30-R20	⊕ 1NO+2NC
C21	<input type="checkbox"/> L				
C22	<input type="checkbox"/> L	LRC22A15-R20	⊖ 2NO+1NC	LRC22A30-R20	⊕ 2NO+1NC
C2	<input type="checkbox"/> R				
Max. speed		Type 2		Type 1	
Min. force		4.5 N (25 N ⊕)		0.07 Nm (0.25 Nm ⊖)	
Travel diagrams		Group 1		Group 4	

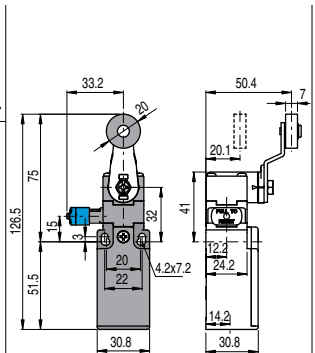
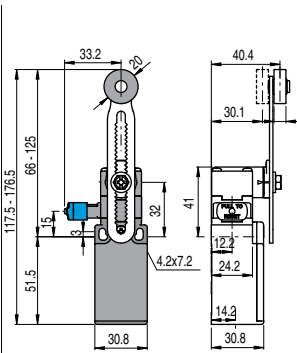
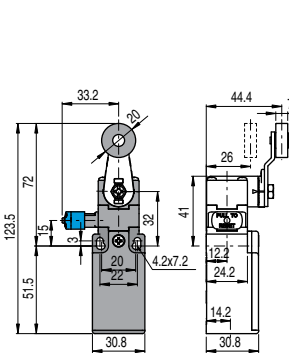
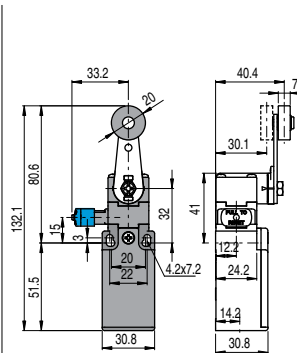

Contact blocks

C6	<input type="checkbox"/> L				
C9	<input type="checkbox"/> L	LRC9A52-R20	⊖ 2NC	LRC9A54-R20	⊕ 2NC
C10	<input type="checkbox"/> L				
C20	<input type="checkbox"/> L	LRC20A52-R20	⊖ 1NO+2NC	LRC20A54-R20	⊕ 1NO+2NC
C21	<input type="checkbox"/> L				
C22	<input type="checkbox"/> L	LRC22A52-R20	⊖ 2NO+1NC	LRC22A54-R20	⊕ 2NO+1NC
C2	<input type="checkbox"/> R				
Max. speed		Type 1		Type 1	
Min. force		0.07 Nm (0.25 Nm ⊕)		0.07 Nm (0.25 Nm ⊕)	
Travel diagrams		Group 4		Group 4	

All measures in the drawings are in mm

Increased actuating force

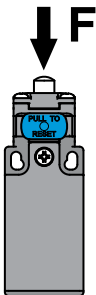

The switch can be delivered with increased actuating force (option RI). Ideal for applications with vibrations.

Actuators	Min. force
01, 14, 15, 16	7 N
02, 05	6 N
07	3.5 N
30 ... 57	0.08 Nm

Position switches with revolving lever without actuator

Contact type:

- R** = snap action
- L** = slow action
- LO** = slow action overlapped
- LS** = slow action shifted
- LV** = slow action shifted and spaced
- LI** = slow action independent
- LA** = slow action closer
- PNP** = electronic PNP

With manual reset knob

All measures in the drawings are in mm

IMPORTANT
For safety applications: join only switches and actuators marked with symbol aside the product code.

Contact blocks	Product Code	Configuration	Product Code	Configuration
C5	R LRC5A38-20	➔ 1NO+1NC		
C6	L LRC6A38-20	➔ 1NO+1NC	LRC6A38-R20	➔ 1NO+1NC
C7	LO LRC7A38-20	➔ 1NO+1NC		
C9	L LRC9A38-20	➔ 2NC	LRC9A38-R20	➔ 2NC
C10	L LRC10A38-20	2NO	LRC10A38-R20	2NO
C11	R LRC11A38-20	➔ 2NC		
C12	R LRC12A38-20	2NO		
C13	LV LRC13A38-20	➔ 2NC		
C14	LS LRC14A38-20	➔ 2NC		
C15	LS LRC15A38-20	2NO		
C16	LI LRC16A38-20	➔ 2NC		
C18	LA LRC18A38-20	➔ 1NO+1NC		
C20	L LRC20A38-20	➔ 1NO+2NC	LRC20A38-R20	➔ 1NO+2NC
C21	L LRC21A38-20	➔ 3NC	LRC21A38-R20	➔ 3NC
C22	L LRC22A38-20	➔ 2NO+1NC	LRC22A38-R20	➔ 2NO+1NC
C2	R LRC2A38-20	2x(1NO-1NC)	LRC2A38-R20	2NO+2NC
CE1	PNP LRCE1A38-20	1NO-1NC		
Min. force	0.06 Nm (0.25 Nm ➔)		0.07 Nm (0.25 Nm ➔)	
Travel diagrams	Group 5		Group 4	

All measures in the drawings are in mm

Loose actuators

All measures in the drawings are in mm

IMPORTANT: These loose actuators can be used with items of series LR, LM, LX, LZ and LK only.

Technopolymer roller Ø 18 mm	Technopolymer roller Ø 18 mm	Adjustable square rod, 3x3x125 mm	Flexible rod with pointed end	Adjustable round rod Ø 3x125 mm	Technopolymer roller Ø 20 mm	
AC-CAE30 ➔	AC-CAE31 ➔	AC-CAE33	AC-CAE34	AC-CAE50	AC-CAE51 ➔	
Technopolymer roller Ø 20 mm	Porcelain roller	Technopolymer roller Ø 20 mm	Adjustable actuator with technopolymer roller	Adjustable safety actuator with technopolymer roller	Technopolymer roller Ø 20 mm	Adjustable fiber glass rod
AC-CAE52 ➔	AC-CAE53 ➔ (2)	CA-CAE54 ➔	AC-CAE55 ➔ (1)	AC-CAE56 ➔	AC-CAE57 ➔	AC-CAE69

- (1) Actuator AC-CAE55 can only be used in safety applications if adjusted to its max. length, as shown in figure beside. If you need an adjustable lever for safety applications, use the adjustable safety lever AC-CAE56.
- (2) The position switch obtained by assembling switch LM • A38-20 (e.g. LMC5A38-20, LMC6A38-20...) with actuator AC-CAE53 will not present the same travel diagrams and actuating forces as switch LM • A53-JOST (e.g. LMC5A53-JOST, LMC6A53-JOST...).
- (4) The actuator cannot be rotated to the inside because it will mechanically interfere with the switch head.

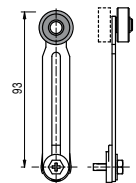

Special loose actuators

All measures in the drawings are in mm

IMPORTANT: These loose actuators can be used with items of series LR, LM, LX, LZ and LK only.

Stainless steel rollers, Ø 20 mm

AC-CAE31-R24 (1)	AC-CAE51-R24 (1)	AC-CAE52-R24 (1)	AC-CAE54-R24 (1)	AC-CAE55-R24 (1) (1)	AC-CAE56-R24 (1)	AC-CAE57-R24 (1)

Technopolymer rollers, Ø 35 mm

AC-CAE31-R25 (4)	AC-CAE51-R25 (4)	AC-CAE52-R25 (4)	AC-CAE54-R25 (4)	AC-CAE55-R25 (1) (1)	AC-CAE56-R25 (1)	AC-CAE57-R25 (1)

Rubber rollers, Ø 40 mm

AC-CAE31-R5 (4)	AC-CAE51-R5 (4)	AC-CAE52-R5 (4)	AC-CAE54-R5 (4)	AC-CAE55-R5 (1) (1)	AC-CAE56-R5 (1)	AC-CAE57-R5 (4)

Rubber rollers, Ø 50 mm

AC-CAE51-R26 (4)	AC-CAE2-R26 (4)	AC-CAE54-R26 (4)	AC-CAE55-R26 (1) (1)	AC-CAE56-R26 (1)	AC-CAE57-R26 (4)

Protruding rubber rollers, Ø 50 mm

AC-CAE55-R27 (1) (1)	AC-CAE56-R27 (1)

Maximum and minimum actuation speed

Lever with roller - Type 1

Ø	Vmax (m/s)	Vmin (mm/s)	
		L	R
15°	2.5	9	0.07
30°	1.5	8	
45°	1	7	
60°	0.75	7	

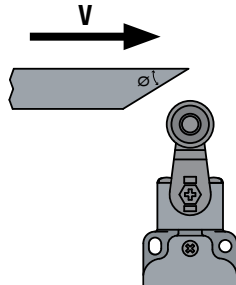

Plunger with roller - Type 2

Ø	Vmax (m/s)	Vmin (mm/s)	
		L	R
15°	1	4	0.04
30°	0.5	2	0.02
45°	0.3	1	0.01

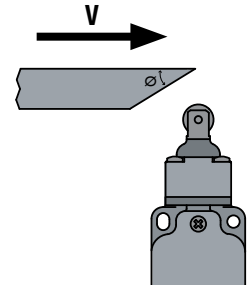

Lever with roller - Type 3

Ø	Vmax (m/s)	Vmin (mm/s)	
		L	R
15°	1	5	0.05
30°	0.5	2.5	0.025
45°	0.3	1.5	0.015

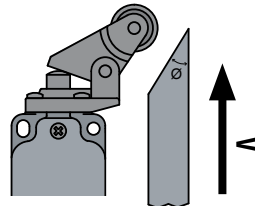

Plunger with roller - Type 5

Ø	Vmax (m/s)	Vmin (mm/s)	
		L	R
15°	0.3	4	0.04
30°	0.2	2	0.02

Plunger with roller - Type 4

Vmax (m/s)	Vmin (mm/s)	
	L	R
0.5	1	0.01

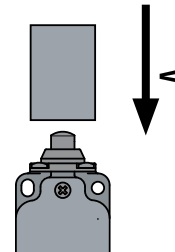

Contacts Type:

- R = snap action
- L = slow action

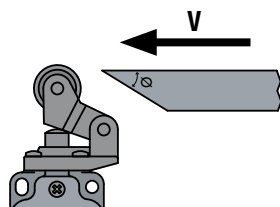

Driving Torques For LR and LX series only

- | | | |
|---|--|---|
| 1 | Cover screws | 0.8...1.2Nm |
| 2 | Head screws | 0.8...1.2Nm |
| 3 | Lever screws | 0.8...1.2Nm |
| 4 | Protection plugs | 1.2...1.6Nm
(conduit entry M20/PG13.5)
(conduit entry M16/PG11) |
| 5 | Contact block screws | 1.0...1.4Nm
0.6...0.8Nm |
| 6 | M5 screws of the housing fastening with washer | 2.0...3.0Nm |

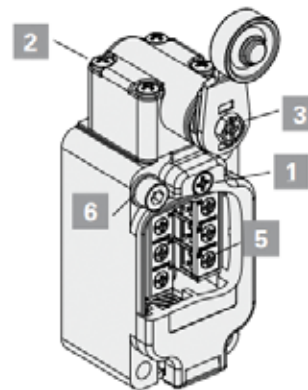

Travel Diagrams

Contact block		Group 1	Group 2	Group 3	Group 4
6 1NO+1NC					
9 2NC					
10 2NO					
20 1NO+2NC					
21 3NC					
22 2NO+1NC					
33 1NO+1NC					
34 2NC					
2 2x(1NO-1NC)					

Legend
 Closed contact | Opened contact | Positive opening travel | Pushing the switch / Releasing the switch

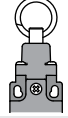
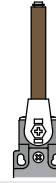
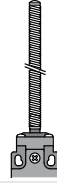

Contact block	Group 1	Group 2	Group 3	Group 4	Group 5	Group 6	Group 7 inverted contacts
2 2x(1NO-1NC)							
3 1NO-1NC							
5 1NO+1NC							
6 1NO+1NC				/			
7 1NO+1NC				/			
9 2NC				/			
10 2NO							
11 2NC				/		/	
12 2NO							
13 2NC				/			
14 2NC				/			
15 2NO				/			
16 2NC	/	/	/	/		/	/
18 1NO+1NC							
20 1NO+2NC							
21 3NC							
22 2NO+1NC							
28 1NO+2NC				/			
29 3NC				/			
30 3NC				/			
33 1NO+1NC							
34 2NC							
37 1NO+1NC				/			
66 1NC							
67 1NO							

Legend
 Closed contact | Opened contact | Positive opening travel | Pushing the switch / Releasing the switch