

# PC F 85 G

**FIBOX**  
Enclosing innovations



Sample image

**Order symbol:** PC F 85 G

**Product nbr:** 8724312

**UL Code:** 8714312

**UL Name:** UL PC F 85 G

**Description:** Enclosure. PC

**Remarks:** Opaque cover

**Including:** Base with screws for mounting plate/DIN-rail. cover with PUR gasket and polyamide cover screws.

**EAN:** 6418074002211

**El. number:**

- Finland: 3423415
- Denmark: 8212001637
- Sweden: 2536823

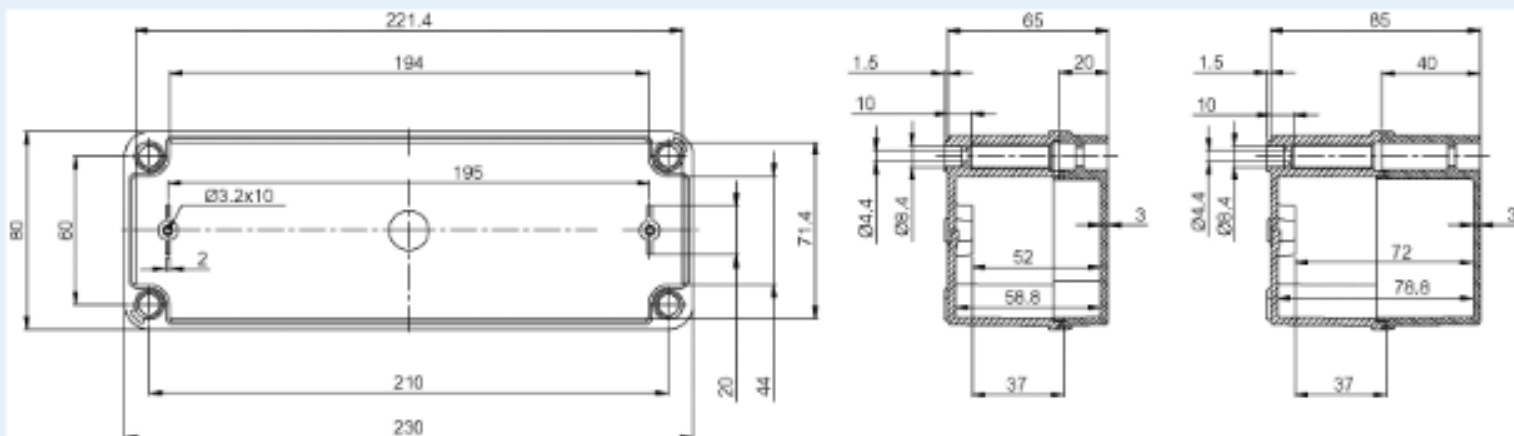

Dimensions:	Height	Width	Depth
mm:	230	80	85
inch:	9.06	3.15	3.35

#### Materials:

Material:	Polycarbonate
Base colour:	RAL 7035 -light grey
Cover colour:	RAL 7035 -light grey
Gasket material:	Polyurethane

#### Temperatures:

Temperature °C (short term):	-40 ... 120
Temperature °C (continuous):	
Temperature °F (short term):	-40 ... 250
Temperature °F (continuous):	-40 ... 175

#### Accessories:

FP 22040	Mounting foot kit (2 pcs). for enclosures:
F-MP	Back Panel. for enclosures: (200 x 54 x 1)
FM-3	DIN-35 Mounting rail. for enclosures: (35 x 200 x 1)

#### Rating:

Ingress protection (EN 60529):	IP66; IP67;
Impact Resistance (EN 62262):	IK08;
Electrical insulation:	Totally insulated
Halogen free (DIN/VDE 0472, Part 815):	1
UV resistance:	UL 508
Flammability Rating:	UL 746C 5*
Glow Wire Test (IEC 695-2-1) °C:	960 °C
NEMA Class	

#### Certificates:

SGSFIMKO\_PICC\_pc