

**DETAIL A
SCALE 1 / 2
END VENTS**

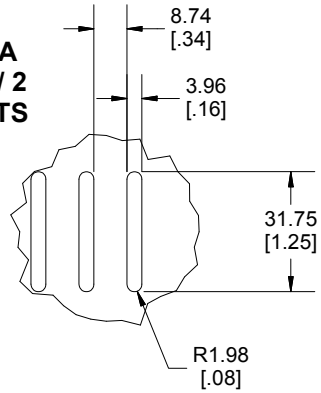

TOP VIEW OF ENCLOSURE

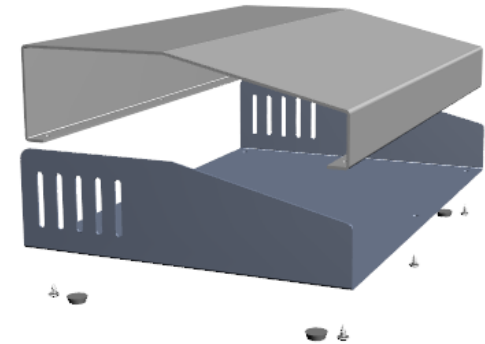
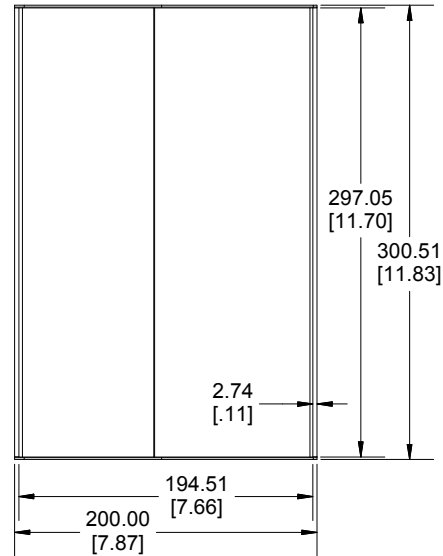

BACK VIEW OF ENCLOSURE

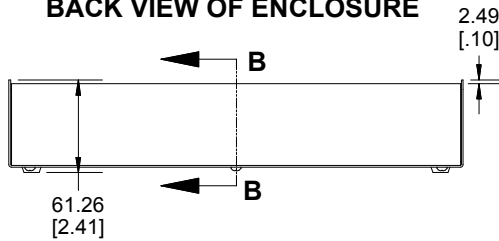

END VIEW OF ENCLOSURE

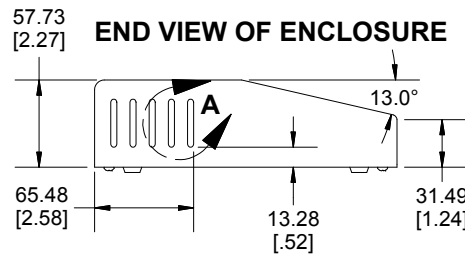

FRONT VIEW OF ENCLOSURE

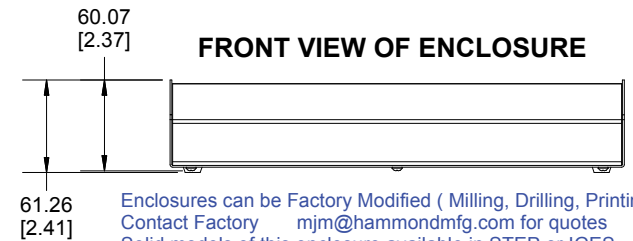

**SECTION B-B
END VIEW**

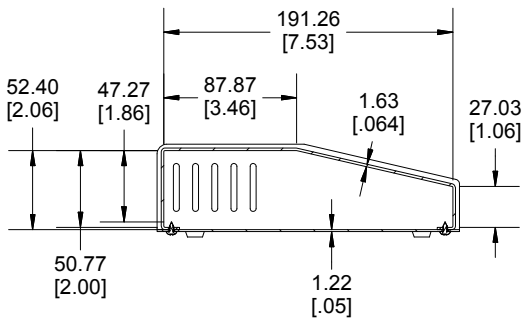

BOTTOM VIEW OF ENCLOSURE

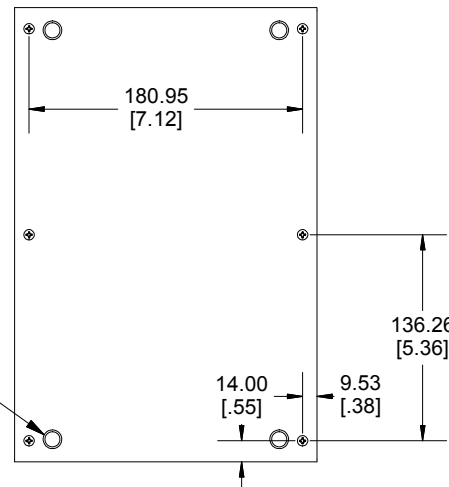

ADHESIVE RUBBER FEET

Enclosures can be Factory Modified (Milling, Drilling, Printing etc.)
Contact Factory mjm@hammondmfg.com for quotes
Solid models of this enclosure available in STEP or IGES.

NOTE

Case Includes Adhesive Rubber Feet and Required Hardware.
Enclosure Case is Made of 0.05" Steel.
Top Panel is Made of 0.064" Aluminum.

PART NUMBERS

515-0950 Enclosure

Smooth Light Grey Top Case
Dark Satin Grey Base Case

515-0950

ACCESSORIES

Plated Cover Screws (Pkg 50)
[#6 x 1/4 Self Tapping]

SC19482-50

Grey Self-Adhesive Rubber Feet (Pkg 4)

1421T2GY

**HAMMOND
MANUFACTURING™**

515-0950

www.hammondmfg.com

Dimensions:
mm
[inches]