

TOP VIEW

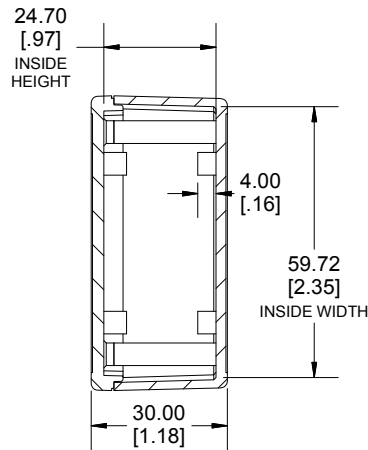

**SECTION A-A
END VIEW**

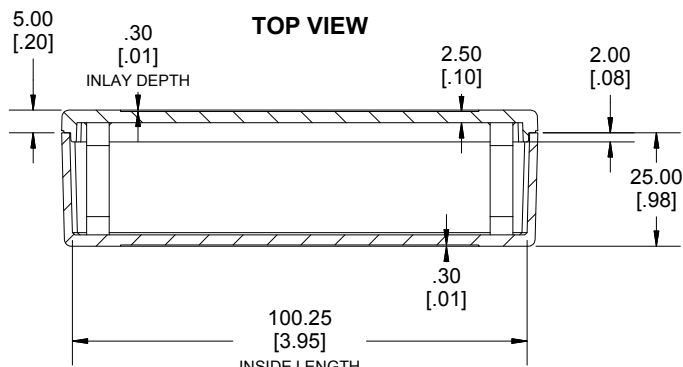
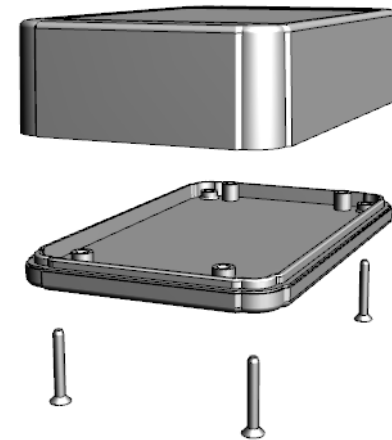

**SECTION B-B
SIDE VIEW**

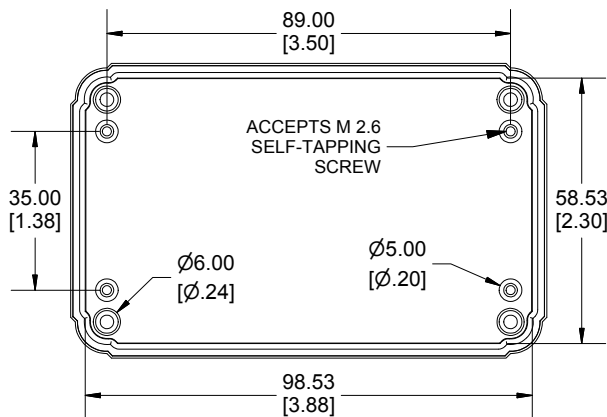

INSIDE LID

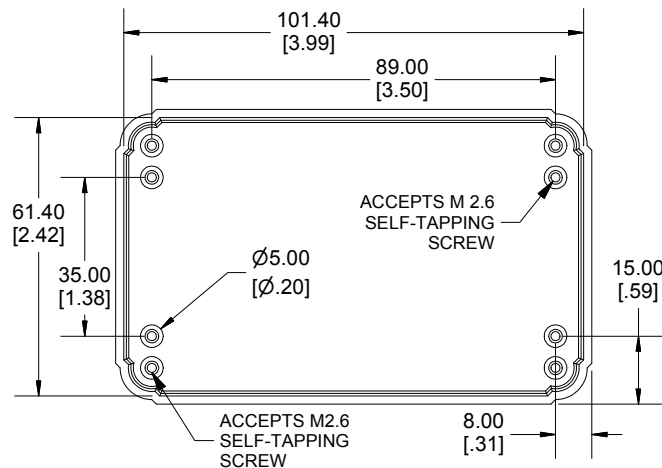

INSIDE BOX

Enclosures can be Factory Modified (Milling, Drilling, Printing etc.)
 Contact Factory mjm@hammondmfg.com for quotes
 Solid models of this enclosure available in STEP or IGES.
 (Part number and text placement/orientation on our products are subject to change,
 we do not recommend using them as a locating reference for modification purposes)

NOTE

Purchased assembly includes box, lid, 4 PCB screws, and 4 cover screws.

Recommended Torque : (64-71) Ozf.in / (45-50) cN.m

RL Enclosure

General Purpose ABS Light Grey (UL94 HB)	RL6165
General Purpose ABS Black (UL94 HB)	RL6165BK

ACCESSORIES

Lid Screw (M2.6 X 18mm Self-tapping) (50 Pkg)	SC520-50
PCB Screw (M2.6 X 6mm Self-tapping) (50 Pkg)	SC519-50

**HAMMOND
MANUFACTURING**

RL6165

www.hammondmfg.com

Dimensions:
mm
[inches]