

50mm Ultra-thin Speakers



DESCRIPTION

Low Profile full range paper cone speakers just 10mm thick.

DISTINCTIVE FEATURES

- Paper cone
- 50mm diameter
- 10mm depth
- Solder tag termination
- Fitted with flange to assist mounting
- Nominal power 0.2W
- 8R Impedance

APPLICATIONS

Wide range speakers are suitable for speech, music and indication purposes. Ultra-slim design allows use where space is at a premium.

**50mm
Ø**

**8R
Impedance**

85dB

**Max
0.5W**



ELECTRICAL SPECIFICATION

Impedance	8R
Power Handling (Nominal)	0.2W
Power Handling (Peak)	0.5W
Voicecoil Impedance	8Ω ± 15% at 750 Hz
Polarity	When a positive D.C. current is applied to the voice coil terminal marked + the diaphragm shall move forward
Insulation Voltage	100V A.C. 50 or 60 Hz/sec voltage at voicecoil and frame, test 1 minute
Insulation Resistance	D.C. 500V at voicecoil and frame test. Resistance value not under 20m Ω
Revc	8.7Ω
Zo	9.96Ω



GENERAL SPECIFICATION

Type	Mylar cone miniature speaker
Nominal Size	50mm diameter
Resonant Frequency	468 ± 15% HZ AT 1V
Frequency Response Deviation	(FO~ 4200HZ) MAX 10 dB
Sensitivity	90 ± 2 dB (1 W 100CM)
Flux Density	1.4 Gauss
QTS (Total Damping)	2.07
QMS (Mechanical Damping)	5.56
QES (Electro-mechanical Damping)	3.31
VAS	0.07 Litre



MATERIALS

Cone	Paper
Frame	Mild Steel
Terminals	Tin plated Brass



ENVIRONMENTAL/OPERATING SPECIFICATION

Heat Resistance	70 ± 2°C 16 hr
Humidity Resistance	40 ± 2°C 96 hr 90%
Vibration Test	Less than 10Hz – 55Hz - 10Hz/min double amplitude 1.5mm test time 1hr
Cold Resistance	-20 ± 2°C 16 hr



TERMINALS

Terminal Type	Solder Tag
---------------	------------



DIMENSIONS/DRAWINGS

Units	mm - unless stated otherwise
Dimensions	50mm dia x 10mm Deep
Magnet Dimensions	12.5 x 2MM
Weight	16g

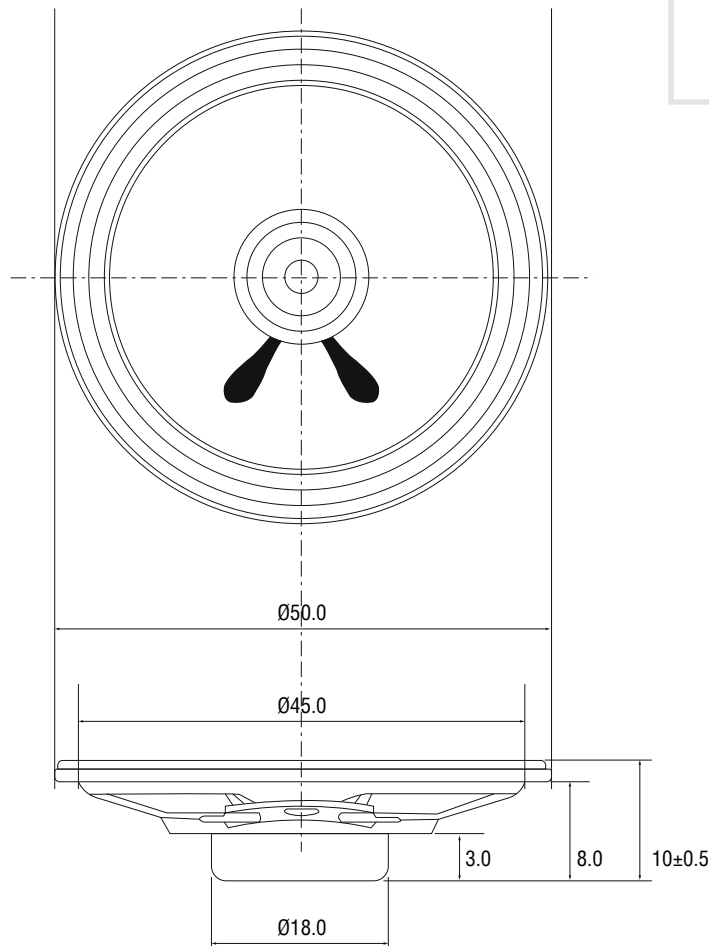

PART NUMBER TABLE

Part Number	Impedance	EAN	UNSPSC	Country of origin
35-0910	8 Ω	5053556001606	52161512	China

R-TECH

Tried & trusted technology

Important Notice: This data sheet and its contents (the "Information") belong to Rapid Electronics Limited or are licensed to it. No licence is granted for the use of it other than for information purposes in connection with the products to which it relates. No licence of any intellectual property rights is granted. The Information is subject to change without notice and replaces all data sheets previously supplied. The Information supplied is believed to be accurate but Rapid Electronics Limited assumes no responsibility for its accuracy or completeness, any error in or omission from it or for any use made of it. Users of this data sheet should check for themselves the Information and the suitability of the products for their purpose and not make any assumptions based on information included or omitted. Liability for loss or damage resulting from any reliance on the Information or use of it (including liability resulting from negligence or where Rapid Electronics Limited were aware of the possibility of such loss or damage arising) is excluded. This will not operate to limit or restrict Rapid Electronics Limited's liability for death or personal injury resulting from its negligence.