



# 規格承認書

## Specification For Approval

客戶 Customer: \_\_\_\_\_  
客戶代號 Customer Code: \_\_\_\_\_ B652 \_\_\_\_\_  
客戶品號 Customer Part No.: \_\_\_\_\_

產品名稱 Product Name: \_\_\_\_\_ DC Fan \_\_\_\_\_  
型號 Model No.: \_\_\_\_\_ RDH8025S2 \_\_\_\_\_  
產品品號 Part No.: \_\_\_\_\_

編號 Spec. No.: \_\_\_\_\_ XRL413Z073 \_\_\_\_\_  
制定日期 Issue Date: \_\_\_\_\_ 2013-12-24 \_\_\_\_\_  
版本 Revision.: \_\_\_\_\_ A00 \_\_\_\_\_

客戶確認簽名欄 Customer Confirmation Signature

此份規格的制定是依據您的當前需求，除非另有修訂，它將是貴公司所有生產訂單最終檔，敬請研究細節，在您確認後的同時返回給我們有清晰簽名的副本。

This specification is made according to your current inquiry , unless otherwise revised, It will be final document for all future production of orders from your respected company , Kindly study in details and return to us the duplicate clear signed as your confirmation same.

批准 Approved By	檢查 Checked By	準備 Prepared By
肖云海	余宽兴	程晶



## 修改记录 Revised Record

版本 Rev	修订简述 Revision Description	日期 Date
A00	首次制作	13/12/24

1. 适用范围 Scope

此份规格书定义了产品的电气及机械特性。

This specification defines the electrical and mechanical characteristics of the product.

2. 一般规格 General Specification

序号 No.	项目 Item	规格 Specification	单位 Unit
1	额定电压 Rated Voltage	24	VDC
2	工作电压 Operating Voltage	12.0~27.6	VDC
3	标签电压 Label Voltage	24	VDC
4	输入电流 Input Current	0.15(Max.0.17)	A
5	标签电流 Label Current	0.15	A
6	输入功率 Input Power	3.60(Max.4.14)	W
7	转速 Speed	3000 ± 10%	RPM
8	最大风量(零静压时)Max. Air Flow(At Zero Static Pressure)	41.06(Min. 36.95)	CFM
9	最大风压 (零风量时) Max. Air Pressure(At Zero Air Flow)	3.45(Min.2.79)	mmH <sub>2</sub> O
10	噪声 Acoustical Noise	33(Max.37)	dB(A)

3. 电气特性 Electrical characteristics

1	绝缘阻抗 Insulation resistance	框与导线正极端子之间加直流 500VDC，最小 10MΩ； Min 10M ohm between frame and positive terminal at 500VDC.
2	绝缘耐压 Dielectric strength	框与导线正极之间加交流 500VAC 1 分钟或 600VAC 1 秒钟，漏电流最大 5 mA； Max 5 mA between frame and positive terminal at 500VAC 1 min or 600VAC 1Sec.
3	预期寿命 (故障率 10%) Life Expectancy (L <sub>10</sub> )	在额定电压，室温 25℃，相对湿度 15%~65%RH 环境中工作时的平均寿命约 30000 小时； Average life is about 30000 hours while fan is operating at rated voltage in room temperature 25℃and relative Humidity 15%~65%RH environment.
4	绝缘等级 Insulated Class	UL: Class A (105℃)
5	安规 Safety Approvals	TP 
6	导线 Lead Wire	UL1007 24AWG； 红色正极 Red Positive(+); 黑色负极 Black Negative(-)

4. 机械特性 Mechanical Characteristics

1	尺寸 Dimension	参见尺寸图 See Dimension Drawing
2	外框 frame	塑料、黑色 Thermoplastic ,Black ,UL94V-0
3	扇叶 Impeller	塑料、黑色 Thermoplastic ,Black ,UL94V-0
4	轴承 Bearing	含油轴承 Sleeve Bearing
5	重量 Weight	Approx. 76g
6	外壳防护 Ingress Protection Rating	NA

5. 环境适应 Environmental

1	运转温度 Operating Temperature	-10 ~ +70 °C
2	储存温度 Storage Temperature	-40 ~ +75 °C
3	运转湿度 Operating Humidity	35% ~ 85%RH
4	储存湿度 Storage Humidity	35% ~ 85%RH
5	环保要求 RoHS Compliance	产品有害物质含量符合欧盟指令 2002/95/EC 要求。 Hazardous substances contents in our products is in compliance with RoHS 2002/95/EC requirement.

6. 保护 Protection

1	极性保护 Polarity Protection	如果端子的正负极接反，产品能够承受 10 分钟不被损坏。 Be capable of withstanding 10 minutes will not cause damage if reverse connection for positive and negative leads.
2	马达锁住保护 Locked Rotor Protection	在额定电压范围和运转温度下，当转子被锁住后电路电流会被关闭或维持很小范围保护马达在 72 小时内不会损坏。 The current will shut down or remain a little range to protect motor from damage in 72 hours when locking rotor at rated voltage and operation temperature.

7. 噪音 Acoustical Noise

风扇悬吊在无响室无风阻运转，在额定电压下麦克风距风扇进风口 1 米的距离测试值。 Fan is hanged in anechoic chamber, noise is measured at rated voltage in free air in anechoic chamber with microphone at a distance of one meter from the air intake .

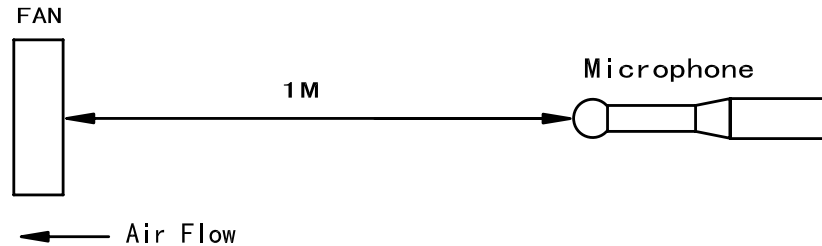

8. 特性曲线 Performance Curve

在运转电压、室温、65%湿度条件下测试。 At operation voltage in room temperature and 65% humidity

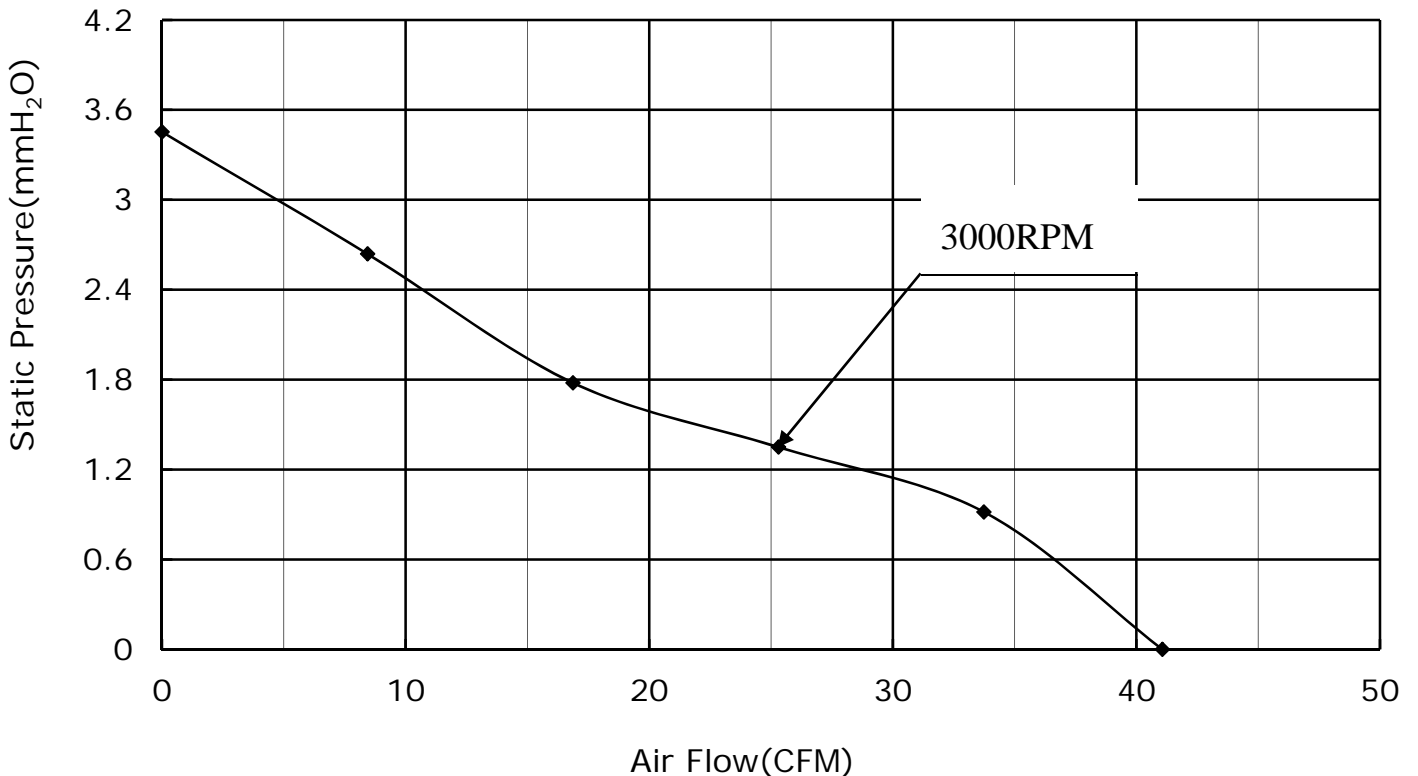

9. 标签 Label



(1)	制造日期 Date Code
(2)	型号 Model No.
(3)	电压 Voltage
(4)	电流 Current
(5)	安规 Safety Approvals
(6)	产地 Location

10. 尺寸图 Dimension Drawing

单位 Unit: mm

- 1. 红色 RED(+)
- 2. 黑色 BLACK(-)

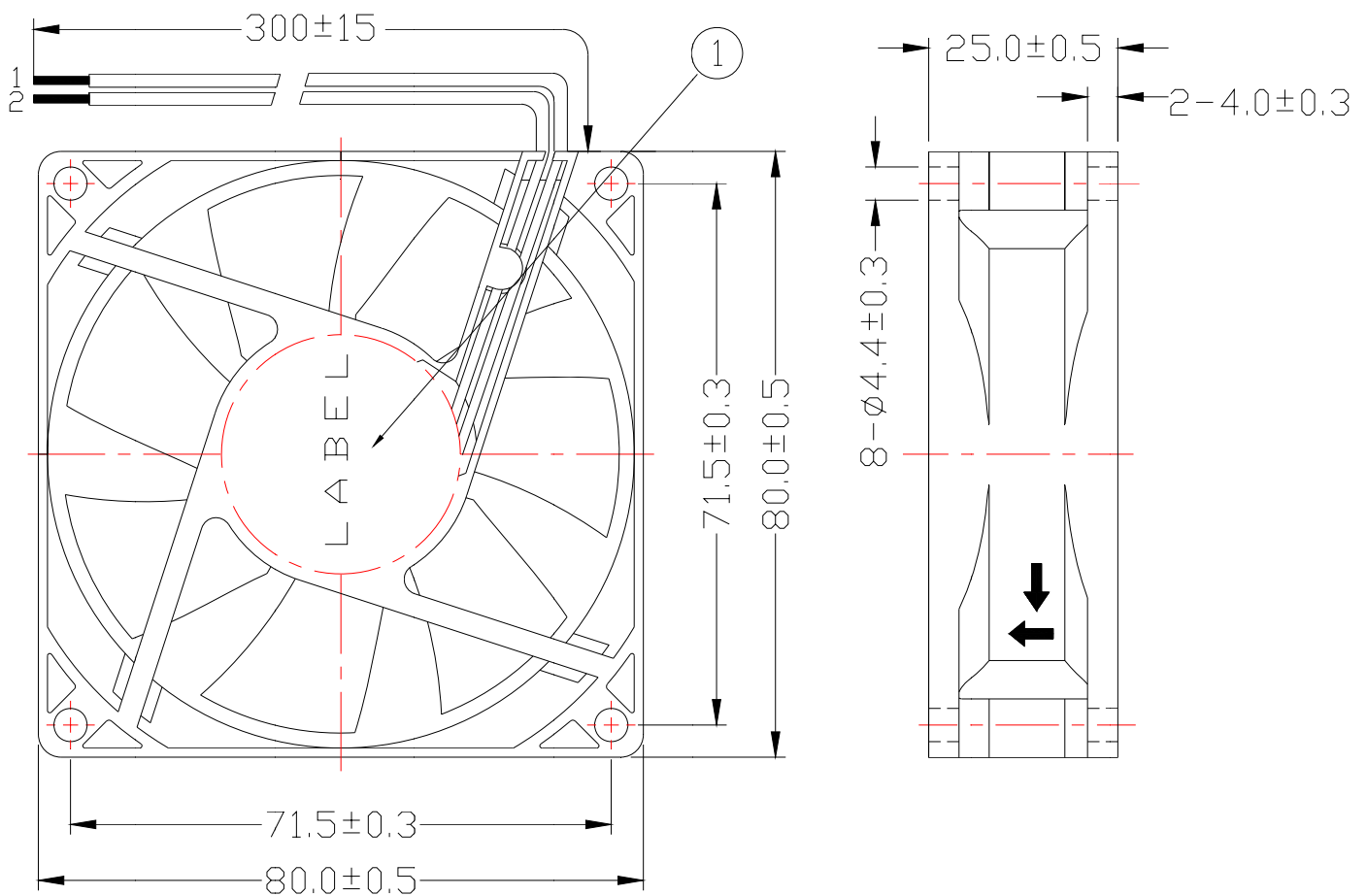

序号 No.	数量 Qty	名称 Part Name	描述 Description
①	1	标签 Label	

## 注解 Notes

1. 我们提供的产品应在规格书指定的条件内使用，如果您的应用超出规格极限我们对此不保证产品质量。We provide products should be used within the specification appointed condition, so we will not guarantee this product quality if your application exceeds the limitations outlined in this specification.
2. 除非事先约定，我们保留使用相等规格多种来源零件的权利，原材料和结构的变更不作预先通知，但确保变更完全符合此份规格书。Unless prior agreement, we reserves the right to use components with equivalent specifications from multiple sources, so material and construction are subject to change without advance notice. this changes should be within this specification here above.
3. 除非事先通知我们所需求参数，否则出货产品与此份规格书一致，未在此份规格书中指定的参数与贵公司最终承认的样品相同。Product will be shipped in accordance with this specification unless we has been previously notified of parameters requiring exception, if parameters which are not specified in this specification will be identical to the final sample which has been approved by your company.
4. 除非特别指出，测量记录是在室温、供给产品接线端的额定电压误差不超过 $\pm 0.1\text{VDC}$ 条件下测试。Unless otherwise specified, marking measurement and tests are on room temperature, power supply provide rated voltage tolerance must not over  $\pm 0.1\text{VDC}$ .
5. 除非特殊设计,在使用期间由于灰尘，水，水滴，露，腐蚀气体、应用缺陷等意外事件可能引起的产品性能下降、安全问题甚至产品失效。Except some special designs, During use against caused by dust, water, droplets, dew, corrosive fluids, application bugs, etc. accidents cause product performance degradation, safety problem even product failures.
6. 在出厂前叶轮和马达被连接起来维持好了平衡，当您使用时不要从马达上分离扇叶，这可能产生振动和减少运转寿命。The impeller and the motor are combined to maintain good balance before this product leave factory, Do not separate the impeller from the motor when you use, This may cause vibration and decrease the operation life.
7. 当风扇在转动时，不要把手指或您的身体的其它部分伸进产品造成人体受伤，更不能放物体到风扇里面造成风扇损坏。Do not put your finger or any other part of your body in to this product when the fan in running , You may get injured, never put an object into the fan, it may damage the fan.
8. 当产品工作时始终遵守规格中指出的运转条件和环境需求（诸如运转电压范围，运转温度范围，电源节点）。Always observe the operating conditions and the environmental requirements indicated in this catalog (such as operating voltage range, operation temperature range, and power connection points) when operation the product.
9. 请小心搬运和安装此产品，碰撞或跌落或用手指等其它物体挤压产品都有可能损坏支架和轴承导致产品在设备工作时产生奇怪的噪音和振动。Please handle and install this product carefully, Hitting or dropping or extruding with fingers or other objects this product may damage holders or bearings. Resulting in strange noise and vibration during equipment operation.
10. 确定在连接和断开连接器之前关掉电源，避免产生电子零件短路。Make sure to turn off the power before connection or disconnecting the connectors. This may cause short of electronic parts.
11. 不适当的安装可能产生刺耳的共振，振动和噪音，请可靠安装。Improper mounting may cause harsh resonance, vibration, and noise. Please mount securely.
12. 确保产品依照指定的储存温湿度存储，不要储存在高温，高湿，有腐蚀气体的环境，如果产品储存超过 6 个月，我们推荐在使用前进行功能性测试。Always ensure that products are stored according to the storage temperatures and humidity specified. Do not store in such as high temperature and high humidity and where there is corrosive gas environment, If the products are stored for more than 6 months, we recommend functional testing before using.



## GPVV2.E186492 Fans, Electric - Component

[Page Bottom](#)

### Fans, Electric - Component

[See General Information for Fans, Electric - Component](#)

**XINRUILIAN SCIENCE & TECHNOLOGY (SHENZHEN) CO LTD**

E186492

BLK A,B,C,D

SANWEI INDUSTRIAL DISTRICT

BAO'AN XI XIANG TOEN

SHENZHEN, GUANGDONG CHINA

**AC fans**, Models RAH1225B1, RAM1225B1, RAL1225B1, RAH1225S1, RAM1225S1, RAL1225S1, RAH1751B1, RAM1751B1, RAL1751B1, RAH1751S1, RAM1751S1, RAL1751S1, RAH1225B2, RAM1225B2, RAL1225B2, RAH1225S2, RAM1225S2, RAL1225S2, RAH1238B2, RAM1238B2, RAL1238B2, RAH1238S2, RAM1238S2, RAL1238S2, RAH1238S2T, RAH1751B2, RAM1751B2, RAL1751B2, RAH1751S2, RAM1751S2, RAL1751S2.

Models RAH8025B1, RAH8025S1, RAH8038B1, RAH8038S1, RAM8038B1, RAM8038S1, RAH9225B1, RAH9225S1, RAH8025B2, RAH8025S2, RAH8038B2, RAH8038S2, RAM8038B2, RAM8038S2, RAH9225B2, RAH9225S2.

Models RA(S)(T)B(W)-C, RA(S)1751(V)(W)-B, RA(S)(U)(V)(W), RA(S)1238(V)(W)-C, RA(S)1238(V)(W)-B, RA(X)1238(V)1, RAL2589B(W)-C Series, where (S) may be H or M, (T) may be 1738, 1538, 1751, 1725 or 1555, (U) may be 1725 or 1555, (V) may be B or S, (W) may be 1 or 2, (X) may be H, M or L; Models RAH1751B2-C1, RAM1751B2-C1, RAH1751B1-C1, RAM1751B1-C1, RAH1538B2-C1, RAM1538B2-C1, RAH1538B1-C1, RAM1538B1-C1.

Models RA(X)1225(Z)(W)-B, RA(X)8025(Z)(W)-C, RA(X)8038(Z)(W)-C, RA(X)9225(Z)(W)-C, RA(X)9238(Z)(W)-C, RA(X)9238(Z)(W), RA(X)1225(Z)(W)-C, RA(Y)1278(Z)(W), RA(X)1278(Z)(W)-C, RAH2260B(W)-C Series, where (W) may be 1 or 2, (X) may be H or M, (Y) may be H, M or L, (Z) may be B or S.

Model RAH2045S(W)-C, where the (W) may be 1 or 2.

Models RAH1245S2, RAH1747B2-C, RAH1759(X)2, where (X) may be B or S.

Models RAD8025B2, RAD9225B2, RAD8038B2, RAD9238B2, RAD1278B2, RAH2589B2-C, RAM2589B2-C, RCH1231S2-C, RCH1231B2-C, RAH6030S2, RAH6030B2.

Model RCL2720S1-C.

Model RAH1350S2.

Models RCH1385S2, RCH1880S2, RCH1726S2-C.

Models REH175X62-2CR, REM220X63-2CR, RAH1238S2P, RCH2110S2-C.

Models REH133X61-2CN, REH175X47-2CN, REH175X62-2CN, REH180X49-2CN, REM180X49-2CN, REL180X49-2CN, REH190X62-2CN, REM190X62-2CN, REL190X62-2CN, REH220X63-2CN, REM220X63-2CN, REL220X63-2CN, REH225X90-2CN, REM225X90-2CN, REL225X90-2CN, REH252X84-2CN, REM252X84-2CN, REL252X84-2CN.

Models RCH1512S2, RCH1713S2, RCH1815S2-C.

Models RCH2048S2-C, RCH2048S2-C1, RCH2258S2-C.

Models RCH2614S2-C, RCH2506S2-C, RCH2294S2-C, RCH2268S2-C.

Models RCH1768S2, RCH1875S2-C.

Model REM225X90-1CN.

Model RCH1448S2.

Models RAH2589B2-C1, RAM2589B2-C1, RAL2589B2-C1, RAH2589B1-C1, RAM2589B1-C1, RAL2589B1-C1.

Models RCL4022B2-C, RCL4022B2-C1.

Model REH190X62-1CN.

**Brushless DC fans**, Models RDM6025S, RDH6025S; Models RDL8025, RDM8025, RDL9025, RDM9025 with suffix "B" or "S" representing ball or sleeve bearing system respectively.

Models RDH4010B, RDH4010S, RDM4010B, RDM4010S, RDL4010B, RDL4010S, RDM4020S, RDH5210B, RDM5210B, RDL5210B, RDH5210S, RDM5210S, RDL5210S, RDH6020S, RDM6020S, RDL6020S, RDH8025B, RDH8025S, RDH9025B, RDH9025S, RDX4010Y1, RDX4010Y-1, RSX4010Y, where X may be H, M or L, Y may be S or B.

Models RDH4028S5, RDM4028S5, RDL4028S5, RDH4028B5, RDM4028B5, RDL4028B5, RDH4028S, RDM4028S, RDL4028S, RDH4028B, RDM4028B, RDL4028B.

**DC fans**, Models RDH1225B, RDH1225S, RDH1238B, RDH1238S, RDH4020B, RDH4020S, RDH6015B, RDH6015S, RDH8015B, RDH8015S, RDL1225B, RDL1225S, RDL1238B, RDL1238S, RDL4020B, RDL4020S, RDL6015B, RDL6015S, RDL8015B, RDL8015S, RDM1225B, RDM1225S, RDM1238B, RDM1238S, RDM6015B, RDM6015S, RDM8015B, RDM8015S, RDX8015Y1, where X may be H, M or L, Y may be S or B.

Models RDH5010B, RDH5010S, RDH6020B, RDH6025B, RDL5010B, RDL5010S, RDL6020B, RDL6025B, RDL6025S, RDM4020B, RDM5010B, RDM5010S, RDM6020B, RDM6025B.

Models RDH1232B DC12V, RDH1232B DC24V, RDH1232B DC48V, RDH1232S DC12V, RDH1232S DC24V, RDH1232S DC48V, RDL1232B DC12V, RDL1232B DC24V, RDL1232B DC48V, RDL1232S DC12V, RDL1232S DC24V, RDL1232S DC48V, RDM1232B DC12V, RDM1232B DC24V, RDM1232B DC48V, RDM1232S DC12V, RDM1232S DC24V, RDM1232S DC48V.

Model RDX1238YZ Series, where X may be H, M or L, Y may be S or B, Z may be 1, 2 or 4.

Models RDH3828y5, RDH3828y, RDH4020y5, RDL3828y5, RDL3828y, RDL4020y5, RDM3828y5, RDM3828y, RDM4020y5, RDD4020y5 Series, where y may be B or S.

Models RDH9232B, RDL9232B, RDM9232B.

Models RD(X)4010(Y)5, RD(X)4028(Y)2, RD(X)4510(Y)5, RD(X)4510(Y), RD(X)5010(Y)5, RD(X)5015(Y)5, RD(X)5015(Y), RD(X)6010B, RD(X)6015(Y)5, RD(X)6025(Y)2, RD(X)8020(Y), RD(X)8020(Y)2, RD(X)8025(Y)2, RD(X)9025(Y)2 Series, where (X) may be H, M or L, (Y) may be B or S.

Models RB(X)9733(Y), RB(X)9733(Y)2, RB(X)9733(Y)4 Series, where (X) may be H, M or L, (Y) may be B or S.

Models RBH5015S, RBM5015S, RBL5015S, RBH5015B, RBM5015B, RBL5015B, RDH9025S APF, RDM9025S APF, RDL9025S APF, RDH9025S BPF, RDM9025S BPF, RDL9025S BPF, RDH9025S APT, RDM9025S APT, RDL9025S APT, RDH9025S BPT, RDM9025S BPT, RDL9025S BPT, RDH9025S BGF, RDM9025S BGF, RDL9025S BGF, RBH1232B, RBM1232B, RBL1232B; RBH1232B2, RBM1232B2, RBL1232B2; RBH1232B4, RBM1232B4, RBL1232B4.

Models RD(A)2510(B)(C), RD(A)3010(B)(C), RD(A)7025(B)(E), RD(A)8025(B)(F) Series, DX-CF101, DX-CF102, DX-CF103, where (A) may be H, M or L, (B) may be S or B, (C) may be 5 or blank, (E) may be 2, 5 or blank, (F) may be L3 or L4.

Models RDH6015(Y)1, RSH6015(Y)1, RDH7015(Y)1, RDH7010(Y)(Z), RDM6015(Y)1, RSM6015(Y)1, RDM7015(Y)1, RDM7010(Y)(Z), RDL6015(Y)1, RSL6015(Y)1, RDL7015(Y)1, RDL7010(Y)(Z) Series, where (Y) may be S or B, (Z) may be 1 or 2.

Models RD(A)4010(B)2, RD(C)4020S2, RD(C)4020B2, RD(A)1225(B)2 Series, where (A) may be H, M or L, (B) may be S or B, (C) may be D, H, M or L.

Models RB(A)5015(B)(C), RB(D)7530(B)(E) Series, where (A) may be L, M or H, (B) may be S or B, (C) may be 2 or 5, (D) may be X, L, M, H or D, (E) may be 1, blank or 2.

Models RD(A)3006(D)5, RD(A)3006(D)1, RD(A)6010(D)1, RD(A)(C)(D)1(E), RD(B)(C)(D)2(E), RD(B)(C)(D)4(E) Series, where (A) may be H, M or L, (B) may be D, H, M, L or X, (C) may be 1555, 1725 or 1751, (D) may be B or S, (E) may be -3 or -5.

Model RS(A)4510(B)1 Series, where (A) may be H, M or L, (B) may be B or S.

Models RDH1225S1, RDM1225S1, RDL1225S1, RDH1225B1, RDM1225B1, RDL1225B1.

Models RDH4015(Y)1, RDM4015(Y)1, RDL4015(Y)1 Series, where (Y) may be S, B or C.

Model RDH9025(X)1 Series, where (X) may be S or B.

Models RDD8025(Y)1, RDH8025(Y)1, RDM8025(Y)1, RDL8025(Y)1, RDH8025(Y)5, RDM8025(Y)5, RDL8025(Y)5, where (Y) may be S or B.

Models RDD8025(X)4 Series, RDD8025(X)4-1 Series, RDH9025(X)4 Series, RBH1881B4, RBH1881B2, where (X) may be B or S.

Models RDL1238B6, RDH1232B6, RDL6025B6, RDL9025B6, RDH1225B6.

Models RDH1338B1, RDH1338B2, RDH1338B4, RDM1338B1, RDM1338B2, RDM1338B4, RDL1338B1, RDL1338B2, RDL1338B4 Series.

Models RDH1225(Y)4, RDM1225(Y)4, RDL1225(Y)4, where (Y) may be B or S.

Models RG(X)4028(Y)1, RG(Z)4028(Y)2, RG(X)8038(Y)1, RG(X)8038(Y)2, RG(X)8038(Y)4 Series, where (X) may be D, H, M or L, (Z) may be H, M or L, (Y) may be S or B.



Model RSH6870(Y)1 series, where (Y) may be S or B.

Models RG(X)4056B1, RG(X)6038(Y)1, RG(X)6038(Y)2, RG(X)6038(Y)4 series, where (X) may be D, H, M or L, (Y) may be B or S.

Model RSM1130(Y)1 series, where (Y) may be B or S.

Models RD(X)8010(Y)5, RD(X)8010(Y)1 series, where (X) may be D, H, M or L, (Y) may be B or S.

**DC low voltage fans**, Models RDD1232(Y)4, RDD8015(Y)1, RD(X)5015(Y)2 Series, where (X) may be D, H, M or L, (Y) may be S or B.

Models RBH9330(Y)1, RBM9330(Y)1, RBL9330(Y)1, RBH9330(Y)1-1, RBM9330(Y)1-1, RBL9330(Y)1-1, RBH9330(Y)2, RBM9330(Y)2, RBL9330(Y)2, RBH9330(Y)2-1, RBM9330(Y)2-1, RBL9330(Y)2-1 Series, where (Y) may be B or S.

Models RDH8025(Y)4, RDM8025(Y)4, RDL8025(Y)4, RDH9225(Y)1, RDM9225(Y)1, RDL9225(Y)1, RDH6025(Y)4, RDM6025(Y)4, RDL6025(Y)4, RDH5012(Y)1, RDM5012(Y)1, RDL5012(Y)1, RGD1238(Y)4, RGH1238(Y)4, RGM1238(Y)4, RGL1238(Y)4, RGH1238(Y)1, RGM1238(Y)1, RGL1238(Y)1, RGH1238(Y)2, RGM1238(Y)2, RGL1238(Y)2 Series, where (Y) may be S or B.

, Model RD(X)4025(Y)1 series, where (X) may be H, M or L; (Y) may be B or S.

Marking: Company name or tradenames "Heng Yang" or "RUILIAN SCIENCE" or trademarks  and model designation.  
[Last Updated](#) on 2012-10-05

---

[Questions?](#)

[Print this page](#)

[Terms of Use](#)

[Page Top](#)

2012 UL LLC

When the UL Leaf Mark is on the product, or when the word "Environment" is included in the UL Mark, please search the [UL Environment database](#) for additional information regarding this product's certification.

The appearance of a company's name or product in this database does not in itself assure that products so identified have been manufactured under UL's Follow-Up Service. Only those products bearing the UL Mark should be considered to be Listed and covered under UL's Follow-Up Service. Always look for the Mark on the product.

UL permits the reproduction of the material contained in the Online Certification Directory subject to the following conditions: 1. The Guide Information, Designs and/or Listings (files) must be presented in their entirety and in a non-misleading manner, without any manipulation of the data (or drawings). 2. The statement "Reprinted from the Online Certifications Directory with permission from UL" must appear adjacent to the extracted material. In addition, the reprinted material must include a copyright notice in the following format: "© 2012 UL LLC".



## GPWV8.E186492 Fans, Electric Certified for Canada - Component

[Page Bottom](#)

### Fans, Electric Certified for Canada - Component

[See General Information for Fans, Electric Certified for Canada - Component](#)

**XINRUILIAN SCIENCE & TECHNOLOGY (SHENZHEN) CO LTD**

E186492

BLK A,B,C,D  
SANWEI INDUSTRIAL DISTRICT  
BAO'AN XI XIANG TOEN  
SHENZHEN, GUANGDONG CHINA

**AC fans**, Models RAH1225B1, RAM1225B1, RAL1225B1, RAH1225S1, RAM1225S1, RAL1225S1, RAH1751B1, RAM1751B1, RAL1751B1, RAH1751S1, RAM1751S1, RAL1751S1, RAH1225B2, RAM1225B2, RAL1225B2, RAH1225S2, RAM1225S2, RAL1225S2, RAH1238B2, RAM1238B2, RAL1238B2, RAH1238S2, RAM1238S2, RAL1238S2, RAH1238S2T, RAH1751B2, RAM1751B2, RAL1751B2, RAH1751S2, RAM1751S2, RAL1751S2.

Models RAH8025B1, RAH8025S1, RAH8038B1, RAH8038S1, RAM8038B1, RAM8038S1, RAH9225B1, RAH9225S1, RAH8025B2, RAH8025S2, RAH8038B2, RAH8038S2, RAM8038B2, RAM8038S2, RAH9225B2, RAH9225S2.

Models RA(S)(T)B(W)-C, RA(S)1751(V)(W)-B, RA(S)(U)(V)(W), RA(S)1238(V)(W)-C, RA(S)1238(V)(W)-B, RA(X)1238(V)1, RAL2589B(W)-C Series, where (S) may be H or M, (T) may be 1738, 1538, 1751, 1725 or 1555, (U) may be 1725 or 1555, (V) may be B or S, (W) may be 1 or 2, (X) may be H, M or L; Models RAH1751B2-C1, RAM1751B2-C1, RAH1751B1-C1, RAM1751B1-C1, RAH1538B2-C1, RAM1538B2-C1, RAH1538B1-C1, RAM1538B1-C1.

Models RA(X)1225(Z)(W)-B, RA(X)8025(Z)(W)-C, RA(X)8038(Z)(W)-C, RA(X)9225(Z)(W)-C, RA(X)9238(Z)(W)-C, RA(X)9238(Z)(W), RA(X)1225(Z)(W)-C, RA(Y)1278(Z)(W), RA(X)1278(Z)(W)-C Series, where (W) may be 1 or 2, (X) may be H or M, (Y) may be H, M or L, (Z) may be B or S.

Model RAH2045S(W)-C, where the (W) may be 1 or 2.

Models RAH1245S2, RAH1747B2-C, RAH1759(X)2, where (X) may be B or S.

Models RAD8025B2, RAD9225B2, RAD8038B2, RAD9238B2, RAD1278B2, RAH2589B2-C, RAM2589B2-C, RCH1231S2-C, RCH1231B2-C, RAH6030S2, RAH6030B2.

Model RCL2720S1-C.

Model RAH1350S2.

Models REH175X62-2CR, REM220X63-2CR, RAH1238S2P, RCH2110S2-C.

Models REH133X61-2CN, REH175X47-2CN, REH175X62-2CN, REH180X49-2CN, REM180X49-2CN, REL180X49-2CN, REH190X62-2CN, REM190X62-2CN, REL190X62-2CN, REH220X63-2CN, REM220X63-2CN, REL220X63-2CN, REH225X90-2CN, REM225X90-2CN, REL225X90-2CN, REH252X84-2CN, REM252X84-2CN, REL252X84-2CN.

Models RCH2048S2-C, RCH2048S2-C1, RCH2258S2-C.

Models RCH1768S2, RCH1875S2-C.

Model REM225X90-1CN.

Model RCH1448S2.

Models RAH2589B2-C1, RAM2589B2-C1, RAL2589B2-C1, RAH2589B1-C1, RAM2589B1-C1, RAL2589B1-C1.

Model RCL4022B2-C.

Model REH190X62-1CN.

**Brushless DC fans**, Models RDM6025S, RDH6025S; Models RDL8025, RDM8025, RDL9025, RDM9025 with suffix "B" or "S" representing ball or sleeve bearing system respectively.

Models RDH4010B, RDH4010S, RDM4010B, RDM4010S, RDL4010B, RDL4010S, RDM4020S, RDH5210B, RDM5210B, RDL5210B, RDH5210S, RDM5210S, RDL5210S, RDH6020S, RDM6020S, RDL6020S, RDH8025B, RDH8025S, RDH9025B, RDH9025S, RDX4010Y1, RDX4010Y-1, RSX4010Y, where X may be H, M or L, Y may be S or B.

Models RDH4028S5, RDM4028S5, RDL4028S5, RDH4028B5, RDM4028B5, RDL4028B5, RDH4028S, RDM4028S, RDL4028S, RDH4028B, RDM4028B, RDL4028B.

**DC fans**, Models RDH1225B, RDH1225S, RDH1238B, RDH1238S, RDH4020B, RDH4020S, RDH6015B, RDH6015S, RDH8015B, RDH8015S, RDL1225B, RDL1225S, RDL1238B, RDL1238S, RDL4020B, RDL4020S, RDL6015B, RDL6015S, RDL8015B, RDL8015S, RDM1225B, RDM1225S, RDM1238B, RDM1238S, RDM6015B, RDM6015S, RDM8015B, RDM8015S, RDX8015Y1, where X may be H, M or L, Y may be S or B.

Models RDH5010B, RDH5010S, RDH6020B, RDH6025B, RDL5010B, RDL5010S, RDL6020B, RDL6025B, RDL6025S, RDM4020B, RDM5010B, RDM5010S, RDM6020B, RDM6025B.

Models RDH1232B DC12V, RDH1232B DC24V, RDH1232B DC48V, RDH1232S DC12V, RDH1232S DC24V, RDH1232S DC48V, RDL1232B DC12V, RDL1232B DC24V, RDL1232B DC48V, RDL1232S DC12V, RDL1232S DC24V, RDL1232S DC48V, RDM1232B DC12V, RDM1232B DC24V, RDM1232B DC48V, RDM1232S DC12V, RDM1232S DC24V, RDM1232S DC48V.

Model RDX1238YZ Series, where X may be H, M or L, Y may be S or B, Z may be 1, 2 or 4.

Models RDH3828y5, RDH3828y, RDH4020y5, RDL3828y5, RDL3828y, RDL4020y5, RDM3828y5, RDM3828y, RDM4020y5, RDD4020y5 Series, where y may be B or S.

Models RDH9232B, RDL9232B, RDM9232B.

Models RD(X)4010(Y)5, RD(X)4028(Y)2, RD(X)4510(Y)5, RD(X)4510(Y), RD(X)5010(Y)5, RD(X)5015(Y)5, RD(X)5015(Y), RD(X)6010B, RD(X)6015(Y)5, RD(X)6025(Y)2, RD(X)8020(Y), RD(X)8020(Y)2, RD(X)8025(Y)2, RD(X)9025(Y)2 Series, where (X) may be H, M or L, (Y) may be B or S.

Models RB(X)9733(Y), RB(X)9733(Y)2, RB(X)9733(Y)4 Series, where (X) may be H, M or L, (Y) may be B or S.

Models RBH5015S, RBM5015S, RBL5015S, RBH5015B, RBM5015B, RBL5015B, RDH9025S APF, RDM9025S APF, RDL9025S APF, RDH9025S BPF, RDM9025S BPF, RDL9025S BPF, RDH9025S APT, RDM9025S APT, RDL9025S APT, RDH9025S BPT, RDM9025S BPT, RDL9025S BPT, RDH9025S BGF, RDM9025S BGF, RDL9025S BGF, RBH1232B, RBM1232B, RBL1232B; RBH1232B2, RBM1232B2, RBL1232B2; RBH1232B4, RBM1232B4, RBL1232B4.

Models RD(A)2510(B)(C), RD(A)3010(B)(C), RD(A)7025(B)(E), RD(A)8025(B)(F) Series, DX-CF101, DX-CF102, DX-CF103, where (A) may be H, M or L, (B) may be S or B, (C) may be 5 or blank, (E) may be 2, 5 or blank, (F) may be L3 or L4.

Models RDH6015(Y)1, RSH6015(Y)1, RDH7015(Y)1, RDH7010(Y)(Z), RDM6015(Y)1, RSM6015(Y)1, RDM7015(Y)1, RDM7010(Y)(Z), RDL6015(Y)1, RSL6015(Y)1, RDL7015(Y)1, RDL7010(Y)(Z) Series, where (Y) may be S or B, (Z) may be 1 or 2.

Models RD(A)4010(B)2, RD(C)4020S2, RD(C)4020B2, RD(A)1225(B)2 Series, where (A) may be H, M or L, (B) may be S or B, (C) may be D, H, M or L.

Models RB(A)5015(B)(C), RB(D)7530(B)(E) Series, where (A) may be L, M or H, (B) may be S or B, (C) may be 2 or 5, (D) may be X, L, M, H or D, (E) may be 1, blank or 2.

Models RD(A)3006(D)5, RD(A)3006(D)1, RD(A)6010(D)1, RD(A)(C)(D)1(E), RD(B)(C)(D)2(E), RD(B)(C)(D)4(E) Series, where (A) may be H, M or L, (B) may be D, H, M, L or X, (C) may be 1555, 1725 or 1751, (D) may be B or S, (E) may be -3 or -5.

Model RS(A)4510(B)1 Series, where (A) may be H, M or L, (B) may be B or S.

Models RDH1225S1, RDM1225S1, RDL1225S1, RDH1225B1, RDM1225B1, RDL1225B1.

Models RDH4015(Y)1, RDM4015(Y)1, RDL4015(Y)1 Series, where (Y) may be S, B or C.

Model RDH9025(X)1 Series, where (X) may be S or B.

Models RDD8025(Y)1, RDH8025(Y)1, RDM8025(Y)1, RDL8025(Y)1, RDH8025(Y)5, RDM8025(Y)5, RDL8025(Y)5, where (Y) may be S or B.

Models RDD8025(X)4 Series, RDD8025(X)4-1 Series, RDH9025(X)4 Series, RBH1881B4, RBH1881B2, where (X) may be B or S.

Models RDL1238B6, RDH1232B6, RDL6025B6, RDL9025B6, RDH1225B6.

Models RDH1338B1, RDH1338B2, RDH1338B4, RDM1338B1, RDM1338B2, RDM1338B4, RDL1338B1, RDL1338B2, RDL1338B4Series.

Models RDH1225(Y)4, RDM1225(Y)4, RDL1225(Y)4, where (Y) may be B or S.

Models RG(X)4028(Y)1, RG(Z)4028(Y)2, RG(X)8038(Y)1, RG(X)8038(Y)2, RG(X)8038(Y)4 Series, where (X) may be D, H, M or L, (Z) may be H, M or L, (Y) may be S or B.

Model RSH6870(Y)1 series, where (Y) may be S or B.

Models RG(X)4056B1, RG(X)6038(Y)1, RG(X)6038(Y)2, RG(X)6038(Y)4 series, where (X) may be D, H, M or L, (Y) may be B or S.

Model RSM1130(Y)1 series, where (Y) may be B or S.

Models RD(X)8010(Y)5, RD(X)8010(Y)1 series, where (X) may be D, H, M or L, (Y) may be B or S.

**DC low voltage fans**, Models RDD1232(Y)4, RDD8015(Y)1, RD(X)5015(Y)2 Series, where (X) may be D, H, M or L, (Y) may be S or B.

Models RBH9330(Y)1, RBM9330(Y)1, RBL9330(Y)1, RBH9330(Y)1-1, RBM9330(Y)1-1, RBL9330(Y)1-1, RBH9330(Y)2, RBM9330(Y)2, RBL9330(Y)2, RBH9330(Y)2-1, RBM9330(Y)2-1, RBL9330(Y)2-1Series, where (Y) may be B or S.

Models RDH8025(Y)4, RDM8025(Y)4, RDL8025(Y)4, RDH9225(Y)1, RDM9225(Y)1, RDL9225(Y)1, RDH6025(Y)4, RDM6025(Y)4, RDL6025(Y)4, RDH5012(Y)1, RDM5012(Y)1, RDL5012(Y)1, RGD1238(Y)4, RGH1238(Y)4, RGM1238(Y)4, RGL1238(Y)4, RGH1238(Y)1, RGM1238(Y)1, RGL1238(Y)1, RGH1238(Y)2, RGM1238(Y)2, RGL1238(Y)2 Series, where (Y) may be S or B.

, Model RD(X)4025(Y)1 series, where (X) may be H, M or L; (Y) may be B or S.

Marking: Company name or tradenames "Heng Yang" or "RUILIAN SCIENCE" or trademark  , model designation and Recognized

Component Mark for Canada 

Last Updated on 2012-10-05

---

[Questions?](#)

[Print this page](#)

[Terms of Use](#)

[Page Top](#)

2012 UL LLC

When the UL Leaf Mark is on the product, or when the word "Environment" is included in the UL Mark, please search the [UL Environment database](#) for additional information regarding this product's certification.

The appearance of a company's name or product in this database does not in itself assure that products so identified have been manufactured under UL's Follow-Up Service. Only those products bearing the UL Mark should be considered to be Listed and covered under UL's Follow-Up Service. Always look for the Mark on the product.

UL permits the reproduction of the material contained in the Online Certification Directory subject to the following conditions: 1. The Guide Information, Designs and/or Listings (files) must be presented in their entirety and in a non-misleading manner, without any manipulation of the data (or drawings). 2. The statement "Reprinted from the Online Certifications Directory with permission from UL" must appear adjacent to the extracted material. In addition, the reprinted material must include a copyright notice in the following format: "© 2012 UL LLC".

# Zertifikat

# Certificate



Zertifikat Nr. *Certificate No.*  
R 50019167

Blatt *Page*  
0001

Ihr Zeichen *Client Reference*  
PT/VTC

Unser Zeichen *Our Reference*  
ZTW1-ALD- 10005136 001

Ausstellungsdatum  
07.11.2002

*Date of Issue*  
(day/mo/yr)

**Genehmigungsinhaber *License Holder***

Xinruilian Electronics (Shenzhen)  
Co., Ltd.  
Block A, Sanwei Industrial District  
Xixiang Town, Baoan  
Shenzhen, Guangdong  
P.R. China

**Fertigungsstätte *Manufacturing Plant***

Xinruilian Electronics (Shenzhen)  
Co., Ltd.  
Block A, Sanwei Industrial District  
Xixiang Town, Baoan  
Shenzhen, Guangdong  
P.R. China

**Prüfzeichen *Test Mark***



**Geprüft nach *Tested acc. to***

EN 60950:1992+A1+A2+A3+A4+A11

**Zertifiziertes Produkt (Geräteidentifikation)**  
*Certified Product (Product Identification)*

**Lizenzentgelte - Einheit**  
*License Fee - Unit*

Ventilator (DC Fan)

Bezeichnung (Type Designation)	: RDXYYZZSW	6
X steht für (stands for):	H, M, L	1
YY steht für (stands for):	40, 45, 50, 60, 80, 90, 97	1
ZZ steht für (stands for):	10, 15, 20, 25, 28, 33	1
W steht für (stands for):	2, 4, 5 oder (or) freibleibend (blank)	1

Nennspannung (Rated Voltage)	: DC 24V (W = 2) DC 48V (W = 4) DC 5V (W = 5) DC 12V (W = blank)
Nennstrom (Rated Current)	: siehe Aufbau-Übersicht (see constructional dataform)
Schutzklasse (Protection Class)	: III



10

ANLAGE (Appendix): 1

Dem Zertifikat liegt unsere Prüf- und Zertifizierungsordnung zugrunde.  
Das Produkt entspricht den o.g. Anforderungen, die Herstellung wird überwacht.  
This certificate is based on our Testing and Certification Regulation. The product  
fulfills above-mentioned-requirements, the production is subject to surveillance.

**Zertifizierungsstelle**

**TÜV Rheinland Product Safety GmbH, Am Grauen Stein, D-51105 Köln**

Tel.:(+49/221)8 06 - 13 71 Fax:(+49/221)8 06 - 39 35 e-mail: Althoff@de.tuv.com

**Dipl.-Ing. A. Klinker**

# Zertifikat *Certificate*



Zertifikat Nr. *Certificate No.*  
R 50019167

Blatt *Page*  
0015

Ihr Zeichen <i>Client Reference</i>	Unser Zeichen <i>Our Reference</i>	Ausstellungsdatum	<i>Date of Issue</i> (day/month/year)
12063483/KY150413	ZTW1-- 10005136 013	20.05.2013	

**Genehmigungsinhaber *License Holder***  
Xinruilian Science & Technology  
Co., Ltd.  
2F, No. 1 HsingHua St,  
TouNai, YunLin 630  
Taiwan

**Fertigungsstätte *Manufacturing Plant***  
Xinruilian Electronics (Zhaoqing)  
Co., Ltd.  
Xijiang Industrial District  
Xiaoxiang, Gaoyao, Guangdong 526122  
P.R. China

## Prüfzeichen *Test Mark*

Geprüft nach *Tested acc. to*  
EN 60950-1:2006+A11+A1+A12



Zertifiziertes Produkt (Geräteidentifikation)  
*Certified Product (Product Identification)*

Lizenzentgelte - Einheit  
*License Fee - Unit*

Ventilator (DC Fan)

wie Blatt (as page) 01

Änderung  
(Change)

Prüfgrundlage : siehe oben  
(Test Requirement) (see above)

ANLAGE (Appendix): 1

Dem Zertifikat liegt unsere Prüf- und Zertifizierungsordnung zugrunde und es bestätigt die Konformität des Produktes mit den oben genannten Standards und Prüfgrundlagen. Zusätzliche Anforderungen in Ländern, in denen das Produkt in Verkehr gebracht werden soll, müssen zusätzlich betrachtet werden. Die Herstellung des zertifizierten Produktes wird überwacht.  
*This certificate is based on our Testing and Certification Regulation and states the conformity of the product with the standards and testing requirements as indicated above. Any additional requirements in countries where the product is going to be marketed have to be considered additionally. The manufacturing of the certified product is subject to surveillance.*

**TÜV Rheinland LGA Products GmbH - Tillystraße 2 - 90431 Nürnberg**  
Tel.: (+49/221)8 06 - 13 71 e-mail: cert-validity@de.tuv.com  
Fax: (+49/221)8 06 - 39 35 http://www.tuv.com/safety

Zertifizierungsstelle



**CERTIFICATE**  
Of Conformity  
EC Council Directive 2004/108/EC  
Electromagnetic Compatibility

Registration No.: AT1011645E

Report No.: 201011705E

**Applicant** : Xinruilian Science & Technology Co., Ltd.  
2F, No.1 HsingHua St., TouNai, YunLin, Taiwan R.O.C.

**Product** : DC FAN

**Identification** : Model No. : RDX4028YZ, RDX6020YZ, RDX6025YZ  
RDX8020YZ, RDX8025YZ, RDX9025YZ  
(X=H, M, L; Y=B, S; Z=1 or blank, 2)

**Trade Mark** : X-FAN, XINRUILIAN, RUILIAN

**Rating** : 12V/24V

**Test Standards** : EN 55022: 2006+A1: 2007  
EN 61000-3-2: 2006+A1: 2009+A2: 2009  
EN 61000-3-3: 2008  
EN 55024: 1998+A1: 2001+A2: 2003  
(IEC 61000-4-2: 2008, IEC 61000-4-3: 2010, IEC 61000-4-4: 2004  
IEC 61000-4-5: 2005, IEC 61000-4-6: 2008, IEC 61000-4-8: 2003  
IEC 61000-4-11: 2004)

The certificate of conformity is based on an evaluation of a sample of the above-mentioned product. Technical report and documentation are at the applicant's disposal. This is to certify that the tested sample is in conformity with all provisions of Annex III of Council Directive 2004/108/EC, in its latest amended version, referred to EMC Directive. The certificate does not imply assessment of the production and does not permit the use of Lab's logo. The applicant of the certificate is authorized to use this certificate in connection with EC declaration of conformity to Article 10.1 of the Directive.



Nov. 22, 2010  
Date

Certified by

Daniel Zhu  
Chief Executives



The CE Marking may only be used if all relevant and effective EC Directives are complied with



**Anbotek Compliance Laboratory Limited**  
1/F, 1 /Building, SEC Industrial Park, No.4 Qianhai Road, Tel: (86)755-26014771  
Nanshan District, Shenzhen, 518054, China Fax: (86)755-26014772  
[Http://www.anbotek.com](http://www.anbotek.com) Email: [service@anbotek.com](mailto:service@anbotek.com)