



# 規格承認書

## Specification For Approval

客戶 Customer: \_\_\_\_\_  
客戶代號 Customer Code: \_\_\_\_\_ B652 \_\_\_\_\_  
客戶品號 Customer Part No.: \_\_\_\_\_

產品名稱 Product Name: \_\_\_\_\_ AC Fan \_\_\_\_\_  
型號 Model No.: \_\_\_\_\_ RAH1238B1 \_\_\_\_\_  
產品品號 Part No.: \_\_\_\_\_

編號 Spec. No.: \_\_\_\_\_ XRL513Z005 \_\_\_\_\_  
制定日期 Issue Date: \_\_\_\_\_ 2013-12-04 \_\_\_\_\_  
版本 Revision.: \_\_\_\_\_ A00 \_\_\_\_\_

客戶確認簽名欄 Customer Confirmation Signature

此份規格的制定是依據您的當前需求，除非另有修訂，它將是貴公司所有生產訂單最終檔，敬請研究細節，在您確認後的同時返回給我們有清晰簽名的副本。

This specification is made according to your current inquiry , unless otherwise revised, It will be final document for all future production of orders from your respected company , Kindly study in details and return to us the duplicate clear signed as your confirmation same.

批准 Approved By	檢查 Checked By	準備 Prepared By
尹程明	陆伟刚	黎航





## 1. 适用范围 Scope





此份规格书定义了产品的电气及机械特性。

This specification defines the electrical and mechanical characteristics of the product.

## 2. 一般规格 General Specification

No.	项目 Item	规格 Specification	单位 Unit
1	额定电压 Rated Voltage	230	VAC
2	工作电压 Operating Voltage	185~245	VAC
3	标签电压 Label Voltage	220~240	VAC
4	频率 Frequency	50/60	Hz
5	输入电流 Input Current	0.20	A
6	标签电流 Label Current	0.20	A
7	输入功率 Input Power	28/24	W
8	转速 Speed	2600/3000 ± 10%	RPM
9	最大风量(零静压时)Max. Air Flow(At Zero Static Pressure)	97/111	CFM
10	最大风压(零风量时) Max. Air Pressure(At Zero Air Flow)	7.4/9.3	mmH <sub>2</sub> O
11	噪声 Acoustical Noise	40/44	dB(A)

## 3. 电气特性 Electrical characteristics

1	绝缘阻抗 Insulation resistance	框与导线正极端子之间加直流 500VDC, 最小 10MΩ; Min 10M ohm between frame and positive terminal at 500VDC.
2	绝缘耐压 Dielectric strength	框与导线之间加交流 1500VAC 1 分钟或 1800VAC 1 秒钟漏电流最大 5 mA; Max 5 mA between frame and positive terminal at 1500VAC 1 minutes or 1800VAC 1second.
3	预期寿命 (故障率 10%) Life Expectancy (L <sub>10</sub> )	在额定电压, 室温 25℃, 相对湿度 15%~65%RH 环境中工作时的平均寿命约 50000 小时; Average life is about 50000 hours while fan is operating at rated voltage in room temperature 25℃ and relative Humidity 15%~65%RH environment.
4	绝缘等级 Insulated Class	UL: Class B(130℃)
5	安规 Safety Approvals	ZP    
6	导线 Lead Wire	UL1430, 22AWG; Black;

## 4. 机械特性 Mechanical Characteristics

1	尺寸 Dimension	参见尺寸图 See Dimension Drawing
2	外框 frame	压铸铝、黑色 Die-Cast Aluminum, Black
3	扇叶 Impeller	塑料、黑色 Thermoplastic, Black, UL94V-0
4	轴承 Bearing	滚珠轴承 Ball Bearing
5	重量 Weight	Approx. 500g
6	外壳防护 Ingress Protection Rating	N/A

## 5. 环境适应 Environmental

1	运转温度 Operating Temperature	-10 ~ +70 °C
2	储存温度 Storage Temperature	-40 ~ +75 °C
3	运转湿度 Operating Humidity	35% ~ 85%RH
4	储存湿度 Storage Humidity	35% ~ 85%RH
5	环保要求 RoHS Compliance	产品有害物质含量符合欧盟指令 2002/95/EC 要求。 Hazardous substances contents in our products is in compliance with RoHS 2002/95/EC requirement.

6. 保护 Protection

1	阻抗保护 Impedance Protection	在额定电压范围和运转温度下，阻抗保护马达的绕组保护马达转子被锁住后 72 小时内不会损坏。 Impedance of motor winding protects motor from damage in 72 hours of locking rotor condition at rated voltage and operation temperature.
---	------------------------------	---

7. 噪音 Acoustical Noise

风扇悬吊在无响室无风阻运转，在额定电压下麦克风距风扇进风口 1 米的距离测试值。 Fan is hanged in anechoic chamber, Noise is measured at rated voltage in free air in anechoic chamber with microphone at a distance of one meter from the air intake .

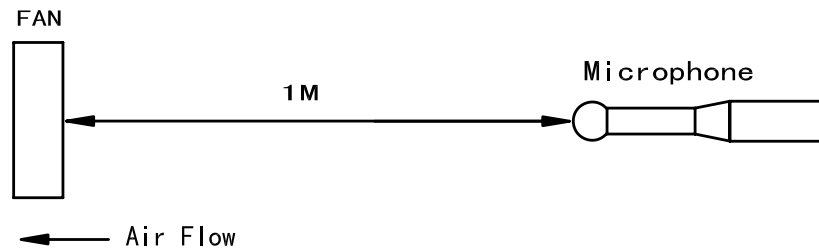

8. 特性曲线 Performance Curve

在运转电压、室温、65%湿度条件下测试。 At operation voltage in room temperature and 65% humidity.

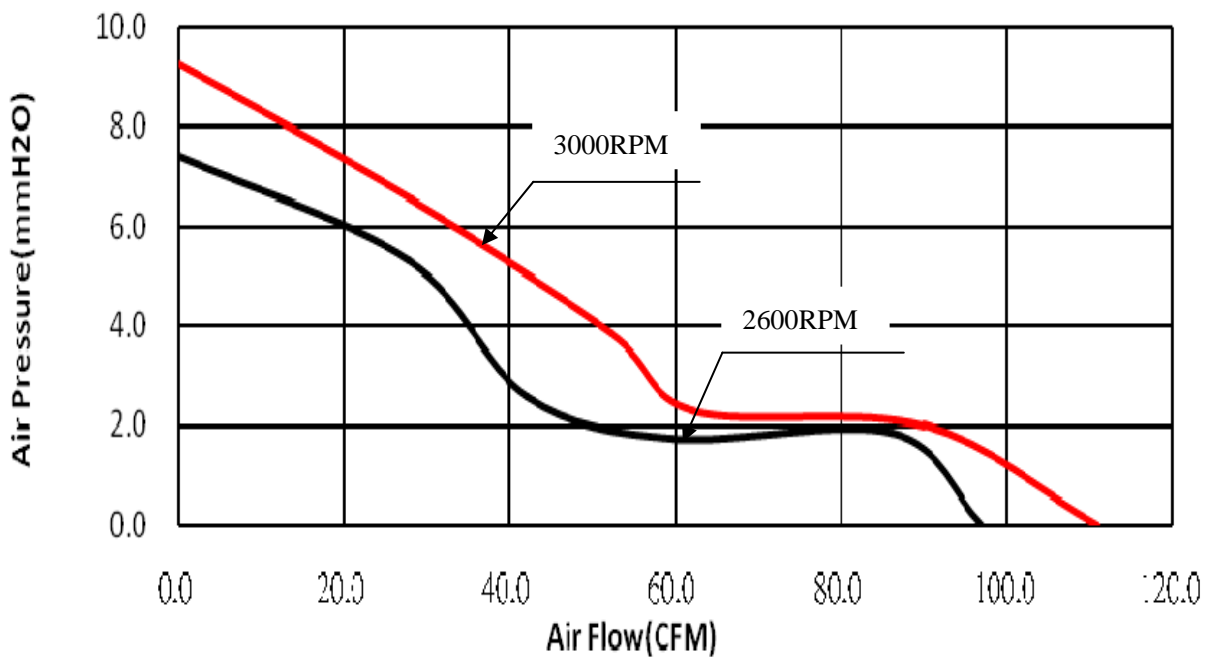

9. 标签 Label



10. 尺寸图 Dimension Drawing

单位 Unit: mm

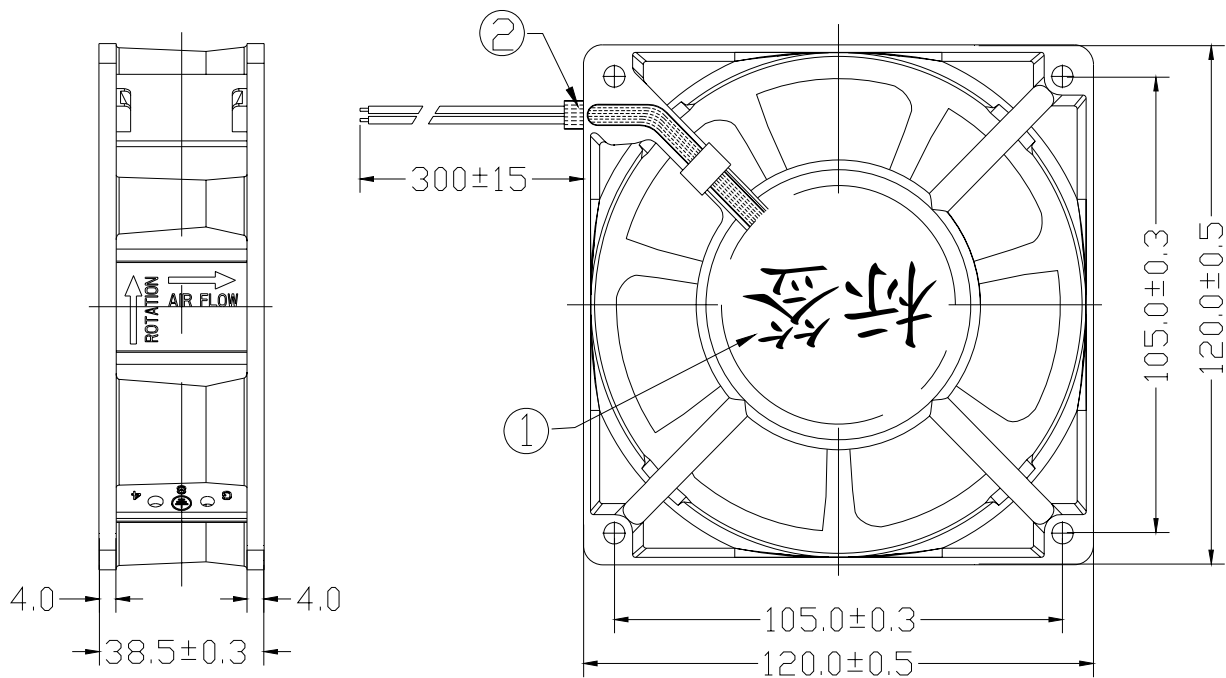

序号 No.	数量 Qty	名称 Part Name	描述 Description
①	1	标签 Label	
②	1	PVC 套管	黑色 Black

## 注解 Notes

1. 我们提供的产品应在规格书指定的条件内使用，如果您的应用超出规格极限我们对此不保证产品质量。  
We provide products should be used within the specification appointed condition, so we will not guarantee this product quality if your application exceeds the limitations outlined in this specification.
2. 除非事先约定，我们保留使用相等规格多种来源零件的权利，原材料和结构的变更不作预先通知，但确保变更完全符合此份规格书。  
Unless prior agreement, we reserves the right to use components with equivalent specifications from multiple sources, so material and construction are subject to change without advance notice. this changes should be within this specification here above.
3. 除非事先通知我们所需求参数，否则出货产品与此份规格书一致，未在此份规格书中指定的参数与贵公司最终承认的样品相同。  
Product will be shipped in accordance with this specification unless we has been previously notified of parameters requiring exception, if parameters which are not specified in this specification will be identical to the final sample which has been approved by your company.
4. 除非特殊设计,在使用期间由于灰尘，水，水滴，露，腐蚀气体、应用缺陷等意外事件可能引起的产品性能下降、安全问题甚至产品失效。  
Except some special designs, During use against caused by dust, water, droplets, dew, corrosive fluids, application bugs, etc. accidents cause product performance degradation, safety problem even product failures.
5. 在出厂前叶轮和马达被连接起来维持好了平衡，当您使用时不要从马达上分离扇叶，这可能产生振动和减少运转寿命。  
The impeller and the motor are combined to maintain good balance before this product leave factory, Do not separate the impeller from the motor when you use, This may cause vibration and decrease the operation life.
6. 当风扇在转动时，不要把手指或您的身体的其它部分伸进产品造成人体受伤，更不能放物体到风扇里面造成风扇损坏。  
Do not put your finger or any other part of your body in to this product when the fan in running , You may get injured, never put an object into the fan, it may damage the fan.
7. 当产品工作时始终遵守规格中指出的运转条件和环境需求（诸如运转电压范围，运转温度范围，电源节点）。  
Always observe the operating conditions and the environmental requirements indicated in this catalog (such as operating voltage range, operation temperature range, and power connection points) when operation the product.
8. 请小心搬运和安装此产品，碰撞或跌落或用手指等其它物体挤压产品都有可能损坏支架和轴承导致产品在设备工作时产生奇怪的噪音和振动。  
Please handle and install this product carefully, Hitting or dropping or extruding with fingers or other objects this product may damage holders or bearings. Resulting in strange noise and vibration during equipment operation.
9. 不适当的安装可能产生刺耳的共振，振动和噪音，请可靠安装。  
Improper mounting may cause harsh resonance, vibration, and noise. Please mount securely.
10. 确保产品依照指定的储存温湿度存储，不要储存在高温，高湿，有腐蚀气体的环境，如果产品储存超过6个月，我们推荐在使用前进行功能性测试。  
Always ensure that products are stored according to the storage temperatures and humidity specified. Do not store in such as high temperature and high humidity and where there is corrosive gas environment, If the products are stored for more than 6 months, we recommend functional testing before using.



# AC成品检查记录表

送检单位	AL 佛山	检验日期	2013.12.6	客户代号	B652
产品型号	RAH1248B1	产品品号		送检数量	2 pc
订单单号	B2Y180	工单单号	SP2513Z005	抽检数量	2 pc
额定电压	230 V 50 HZ	抽样计划: ASQ, C=0 SAMPLING PLANS, AQL: <input type="checkbox"/> 加严0.25 <input type="checkbox"/> 正常0.4			

## 检查记录表

检查项目	规格	样品编号									
		1	2	3	4	5	6	7	8	9	10
1 额定电流	0.20	0.132	0.130								
2 额定转速	3600rpm	2532	2532								
3 起动											
4 噪音		✓	✓								
5 抖动/松动		✓	✓								
6 贴面		✓	✓								
7 功率	28	20.0	20.0								
8 导线规格	300mm	✓	✓								
9 外观检查		✓	✓								
10 风扇尺寸	长度										
	宽度										
	厚度										
11 孔距	扇叶面										
	标签面										
12 孔径	扇叶面										
	标签面										
	地线孔										
13 温控功能											
14 耐压		✓	✓								
15 绝缘阻抗		✓	✓								
16 标签及盖日期的方式											
17 包装方式											
18 环保要求确认		<input checked="" type="checkbox"/> 符合 <input type="checkbox"/> 不符合									

其它样品检验结果:

样品检验 OK

o-FAN

检验结果  合格  不合格  特采

审核:

2013.12.6

检验员:

2013.12.6



# AC成品检查记录表

送检单位	杭州... (handwritten)	检验日期	2013.12.6	客户代号	B652
产品型号	PAH1238B1	产品品号		送检数量	2 pc
订单单号	B2Y180	工单单号	5225132005	抽检数量	2 pc
额定电压	230 V 60 HZ	抽样计划: ASQ, C=0 SAMPLING PLANS, AQL: <input type="checkbox"/> 加严0.25 <input type="checkbox"/> 正常0.4			

## 检查记录表

检查项目	规格	样品编号									
		1	2	3	4	5	6	7	8	9	10
1 额定电流	0.30	0.112	0.112								
2 额定转速	3000±10%	2750	2782								
3 起动											
4 噪音		✓	✓								
5 抖动/松动		✓	✓								
6 贴面		✓	✓								
7 功率	24	17.6	17.5								
8 导线规格	1.0mm	✓	✓								
9 外观检查		✓	✓								
10 风扇尺寸	长度										
	宽度										
	厚度										
11 孔距	扇叶面										
	标签面										
12 孔径	扇叶面										
	标签面										
	地线孔										
13 温控功能											
14 耐压		✓	✓								
15 绝缘阻抗		✓	✓								
16 标签及盖日期的方式											
17 包装方式											
18 环保要求确认		<input checked="" type="checkbox"/> 符合 <input type="checkbox"/> 不符合									

其它样品检验结果:

样品控制 OK XAN

检验结果  合格  不合格  特采 审核: 蔡能 检验员: 李亚明 12/6





## GPVV2.E186492 Fans, Electric - Component

[Page Bottom](#)

### Fans, Electric - Component

[See General Information for Fans, Electric - Component](#)

**XINRUILIAN SCIENCE & TECHNOLOGY (SHENZHEN) CO LTD**

E186492

BLK A,B,C,D

SANWEI INDUSTRIAL DISTRICT

BAO'AN XI XIANG TOEN

SHENZHEN, GUANGDONG CHINA

**AC fans**, Models RAH1225B1, RAM1225B1, RAL1225B1, RAH1225S1, RAM1225S1, RAL1225S1, RAH1751B1, RAM1751B1, RAL1751B1, RAH1751S1, RAM1751S1, RAL1751S1, RAH1225B2, RAM1225B2, RAL1225B2, RAH1225S2, RAM1225S2, RAL1225S2, RAH1238B2, RAM1238B2, RAL1238B2, RAH1238S2, RAM1238S2, RAL1238S2, RAH1238S2T, RAH1751B2, RAM1751B2, RAL1751B2, RAH1751S2, RAM1751S2, RAL1751S2.

Models RAH8025B1, RAH8025S1, RAH8038B1, RAH8038S1, RAM8038B1, RAM8038S1, RAH9225B1, RAH9225S1, RAH8025B2, RAH8025S2, RAH8038B2, RAH8038S2, RAM8038B2, RAM8038S2, RAH9225B2, RAH9225S2.

Models RA(S)(T)B(W)-C, RA(S)1751(V)(W)-B, RA(S)(U)(V)(W), RA(S)1238(V)(W)-C, RA(S)1238(V)(W)-B, RA(X)1238(V)1, RAL2589B(W)-C Series, where (S) may be H or M, (T) may be 1738, 1538, 1751, 1725 or 1555, (U) may be 1725 or 1555, (V) may be B or S, (W) may be 1 or 2, (X) may be H, M or L; Models RAH1751B2-C1, RAM1751B2-C1, RAH1751B1-C1, RAM1751B1-C1, RAH1538B2-C1, RAM1538B2-C1, RAH1538B1-C1, RAM1538B1-C1.

Models RA(X)1225(Z)(W)-B, RA(X)8025(Z)(W)-C, RA(X)8038(Z)(W)-C, RA(X)9225(Z)(W)-C, RA(X)9238(Z)(W)-C, RA(X)9238(Z)(W), RA(X)1225(Z)(W)-C, RA(Y)1278(Z)(W), RA(X)1278(Z)(W)-C, RAH2260B(W)-C Series, where (W) may be 1 or 2, (X) may be H or M, (Y) may be H, M or L, (Z) may be B or S.

Model RAH2045S(W)-C, where the (W) may be 1 or 2.

Models RAH1245S2, RAH1747B2-C, RAH1759(X)2, where (X) may be B or S.

Models RAD8025B2, RAD9225B2, RAD8038B2, RAD9238B2, RAD1278B2, RAH2589B2-C, RAM2589B2-C, RCH1231S2-C, RCH1231B2-C, RAH6030S2, RAH6030B2.

Model RCL2720S1-C.

Model RAH1350S2.

Models RCH1385S2, RCH1880S2, RCH1726S2-C.

Models REH175X62-2CR, REM220X63-2CR, RAH1238S2P, RCH2110S2-C.

Models REH133X61-2CN, REH175X47-2CN, REH175X62-2CN, REH180X49-2CN, REM180X49-2CN, REL180X49-2CN, REH190X62-2CN, REM190X62-2CN, REL190X62-2CN, REH220X63-2CN, REM220X63-2CN, REL220X63-2CN, REH225X90-2CN, REM225X90-2CN, REL225X90-2CN, REH252X84-2CN, REM252X84-2CN, REL252X84-2CN.

Models RCH1512S2, RCH1713S2, RCH1815S2-C.

Models RCH2048S2-C, RCH2048S2-C1, RCH2258S2-C.

Models RCH2614S2-C, RCH2506S2-C, RCH2294S2-C, RCH2268S2-C.

Models RCH1768S2, RCH1875S2-C.

Model REM225X90-1CN.

Model RCH1448S2.

Models RAH2589B2-C1, RAM2589B2-C1, RAL2589B2-C1, RAH2589B1-C1, RAM2589B1-C1, RAL2589B1-C1.

Models RCL4022B2-C, RCL4022B2-C1.

Model REH190X62-1CN.

**Brushless DC fans**, Models RDM6025S, RDH6025S; Models RDL8025, RDM8025, RDL9025, RDM9025 with suffix "B" or "S" representing ball or sleeve bearing system respectively.

Models RDH4010B, RDH4010S, RDM4010B, RDM4010S, RDL4010B, RDL4010S, RDM4020S, RDH5210B, RDM5210B, RDL5210B, RDH5210S, RDM5210S, RDL5210S, RDH6020S, RDM6020S, RDL6020S, RDH8025B, RDH8025S, RDH9025B, RDH9025S, RDX4010Y1, RDX4010Y-1, RSX4010Y, where X may be H, M or L, Y may be S or B.

Models RDH4028S5, RDM4028S5, RDL4028S5, RDH4028B5, RDM4028B5, RDL4028B5, RDH4028S, RDM4028S, RDL4028S, RDH4028B, RDM4028B, RDL4028B.

**DC fans**, Models RDH1225B, RDH1225S, RDH1238B, RDH1238S, RDH4020B, RDH4020S, RDH6015B, RDH6015S, RDH8015B, RDH8015S, RDL1225B, RDL1225S, RDL1238B, RDL1238S, RDL4020B, RDL4020S, RDL6015B, RDL6015S, RDL8015B, RDL8015S, RDM1225B, RDM1225S, RDM1238B, RDM1238S, RDM6015B, RDM6015S, RDM8015B, RDM8015S, RDX8015Y1, where X may be H, M or L, Y may be S or B.

Models RDH5010B, RDH5010S, RDH6020B, RDH6025B, RDL5010B, RDL5010S, RDL6020B, RDL6025B, RDL6025S, RDM4020B, RDM5010B, RDM5010S, RDM6020B, RDM6025B.

Models RDH1232B DC12V, RDH1232B DC24V, RDH1232B DC48V, RDH1232S DC12V, RDH1232S DC24V, RDH1232S DC48V, RDL1232B DC12V, RDL1232B DC24V, RDL1232B DC48V, RDL1232S DC12V, RDL1232S DC24V, RDL1232S DC48V, RDM1232B DC12V, RDM1232B DC24V, RDM1232B DC48V, RDM1232S DC12V, RDM1232S DC24V, RDM1232S DC48V.

Model RDX1238YZ Series, where X may be H, M or L, Y may be S or B, Z may be 1, 2 or 4.

Models RDH3828y5, RDH3828y, RDH4020y5, RDL3828y5, RDL3828y, RDL4020y5, RDM3828y5, RDM3828y, RDM4020y5, RDD4020y5 Series, where y may be B or S.

Models RDH9232B, RDL9232B, RDM9232B.

Models RD(X)4010(Y)5, RD(X)4028(Y)2, RD(X)4510(Y)5, RD(X)4510(Y), RD(X)5010(Y)5, RD(X)5015(Y)5, RD(X)5015(Y), RD(X)6010B, RD(X)6015(Y)5, RD(X)6025(Y)2, RD(X)8020(Y), RD(X)8020(Y)2, RD(X)8025(Y)2, RD(X)9025(Y)2 Series, where (X) may be H, M or L, (Y) may be B or S.

Models RB(X)9733(Y), RB(X)9733(Y)2, RB(X)9733(Y)4 Series, where (X) may be H, M or L, (Y) may be B or S.

Models RBH5015S, RBM5015S, RBL5015S, RBH5015B, RBM5015B, RBL5015B, RDH9025S APF, RDM9025S APF, RDL9025S APF, RDH9025S BPF, RDM9025S BPF, RDL9025S BPF, RDH9025S APT, RDM9025S APT, RDL9025S APT, RDH9025S BPT, RDM9025S BPT, RDL9025S BPT, RDH9025S BGF, RDM9025S BGF, RDL9025S BGF, RBH1232B, RBM1232B, RBL1232B; RBH1232B2, RBM1232B2, RBL1232B2; RBH1232B4, RBM1232B4, RBL1232B4.

Models RD(A)2510(B)(C), RD(A)3010(B)(C), RD(A)7025(B)(E), RD(A)8025(B)(F) Series, DX-CF101, DX-CF102, DX-CF103, where (A) may be H, M or L, (B) may be S or B, (C) may be 5 or blank, (E) may be 2, 5 or blank, (F) may be L3 or L4.

Models RDH6015(Y)1, RSH6015(Y)1, RDH7015(Y)1, RDH7010(Y)(Z), RDM6015(Y)1, RSM6015(Y)1, RDM7015(Y)1, RDM7010(Y)(Z), RDL6015(Y)1, RSL6015(Y)1, RDL7015(Y)1, RDL7010(Y)(Z) Series, where (Y) may be S or B, (Z) may be 1 or 2.

Models RD(A)4010(B)2, RD(C)4020S2, RD(C)4020B2, RD(A)1225(B)2 Series, where (A) may be H, M or L, (B) may be S or B, (C) may be D, H, M or L.

Models RB(A)5015(B)(C), RB(D)7530(B)(E) Series, where (A) may be L, M or H, (B) may be S or B, (C) may be 2 or 5, (D) may be X, L, M, H or D, (E) may be 1, blank or 2.

Models RD(A)3006(D)5, RD(A)3006(D)1, RD(A)6010(D)1, RD(A)(C)(D)1(E), RD(B)(C)(D)2(E), RD(B)(C)(D)4(E) Series, where (A) may be H, M or L, (B) may be D, H, M, L or X, (C) may be 1555, 1725 or 1751, (D) may be B or S, (E) may be -3 or -5.

Model RS(A)4510(B)1 Series, where (A) may be H, M or L, (B) may be B or S.

Models RDH1225S1, RDM1225S1, RDL1225S1, RDH1225B1, RDM1225B1, RDL1225B1.

Models RDH4015(Y)1, RDM4015(Y)1, RDL4015(Y)1 Series, where (Y) may be S, B or C.

Model RDH9025(X)1 Series, where (X) may be S or B.

Models RDD8025(Y)1, RDH8025(Y)1, RDM8025(Y)1, RDL8025(Y)1, RDH8025(Y)5, RDM8025(Y)5, RDL8025(Y)5, where (Y) may be S or B.

Models RDD8025(X)4 Series, RDD8025(X)4-1 Series, RDH9025(X)4 Series, RBH1881B4, RBH1881B2, where (X) may be B or S.

Models RDL1238B6, RDH1232B6, RDL6025B6, RDL9025B6, RDH1225B6.

Models RDH1338B1, RDH1338B2, RDH1338B4, RDM1338B1, RDM1338B2, RDM1338B4, RDL1338B1, RDL1338B2, RDL1338B4 Series.

Models RDH1225(Y)4, RDM1225(Y)4, RDL1225(Y)4, where (Y) may be B or S.

Models RG(X)4028(Y)1, RG(Z)4028(Y)2, RG(X)8038(Y)1, RG(X)8038(Y)2, RG(X)8038(Y)4 Series, where (X) may be D, H, M or L, (Z) may be H, M or L, (Y) may be S or B.

Model RSH6870(Y)1 series, where (Y) may be S or B.

Models RG(X)4056B1, RG(X)6038(Y)1, RG(X)6038(Y)2, RG(X)6038(Y)4 series, where (X) may be D, H, M or L, (Y) may be B or S.

Model RSM1130(Y)1 series, where (Y) may be B or S.

Models RD(X)8010(Y)5, RD(X)8010(Y)1 series, where (X) may be D, H, M or L, (Y) may be B or S.

**DC low voltage fans**, Models RDD1232(Y)4, RDD8015(Y)1, RD(X)5015(Y)2 Series, where (X) may be D, H, M or L, (Y) may be S or B.

Models RBH9330(Y)1, RBM9330(Y)1, RBL9330(Y)1, RBH9330(Y)1-1, RBM9330(Y)1-1, RBL9330(Y)1-1, RBH9330(Y)2, RBM9330(Y)2, RBL9330(Y)2, RBH9330(Y)2-1, RBM9330(Y)2-1, RBL9330(Y)2-1 Series, where (Y) may be B or S.

Models RDH8025(Y)4, RDM8025(Y)4, RDL8025(Y)4, RDH9225(Y)1, RDM9225(Y)1, RDL9225(Y)1, RDH6025(Y)4, RDM6025(Y)4, RDL6025(Y)4, RDH5012(Y)1, RDM5012(Y)1, RDL5012(Y)1, RGD1238(Y)4, RGH1238(Y)4, RGM1238(Y)4, RGL1238(Y)4, RGH1238(Y)1, RGM1238(Y)1, RGL1238(Y)1, RGH1238(Y)2, RGM1238(Y)2, RGL1238(Y)2 Series, where (Y) may be S or B.

, Model RD(X)4025(Y)1 series, where (X) may be H, M or L; (Y) may be B or S.

Marking: Company name or tradenames "Heng Yang" or "RUILIAN SCIENCE" or trademarks  and model designation.  
[Last Updated](#) on 2012-10-05

---

[Questions?](#)

[Print this page](#)

[Terms of Use](#)

[Page Top](#)

2012 UL LLC

When the UL Leaf Mark is on the product, or when the word "Environment" is included in the UL Mark, please search the [UL Environment database](#) for additional information regarding this product's certification.

The appearance of a company's name or product in this database does not in itself assure that products so identified have been manufactured under UL's Follow-Up Service. Only those products bearing the UL Mark should be considered to be Listed and covered under UL's Follow-Up Service. Always look for the Mark on the product.

UL permits the reproduction of the material contained in the Online Certification Directory subject to the following conditions: 1. The Guide Information, Designs and/or Listings (files) must be presented in their entirety and in a non-misleading manner, without any manipulation of the data (or drawings). 2. The statement "Reprinted from the Online Certifications Directory with permission from UL" must appear adjacent to the extracted material. In addition, the reprinted material must include a copyright notice in the following format: "© 2012 UL LLC".



## GPWV8.E186492 Fans, Electric Certified for Canada - Component

[Page Bottom](#)

### Fans, Electric Certified for Canada - Component

[See General Information for Fans, Electric Certified for Canada - Component](#)

**XINRUILIAN SCIENCE & TECHNOLOGY (SHENZHEN) CO LTD**

E186492

BLK A,B,C,D  
SANWEI INDUSTRIAL DISTRICT  
BAO'AN XI XIANG TOEN  
SHENZHEN, GUANGDONG CHINA

**AC fans**, Models RAH1225B1, RAM1225B1, RAL1225B1, RAH1225S1, RAM1225S1, RAL1225S1, RAH1751B1, RAM1751B1, RAL1751B1, RAH1751S1, RAM1751S1, RAL1751S1, RAH1225B2, RAM1225B2, RAL1225B2, RAH1225S2, RAM1225S2, RAL1225S2, RAH1238B2, RAM1238B2, RAL1238B2, RAH1238S2, RAM1238S2, RAL1238S2, RAH1238S2T, RAH1751B2, RAM1751B2, RAL1751B2, RAH1751S2, RAM1751S2, RAL1751S2.

Models RAH8025B1, RAH8025S1, RAH8038B1, RAH8038S1, RAM8038B1, RAM8038S1, RAH9225B1, RAH9225S1, RAH8025B2, RAH8025S2, RAH8038B2, RAH8038S2, RAM8038B2, RAM8038S2, RAH9225B2, RAH9225S2.

Models RA(S)(T)B(W)-C, RA(S)1751(V)(W)-B, RA(S)(U)(V)(W), RA(S)1238(V)(W)-C, RA(S)1238(V)(W)-B, RA(X)1238(V)1, RAL2589B(W)-C Series, where (S) may be H or M, (T) may be 1738, 1538, 1751, 1725 or 1555, (U) may be 1725 or 1555, (V) may be B or S, (W) may be 1 or 2, (X) may be H, M or L; Models RAH1751B2-C1, RAM1751B2-C1, RAH1751B1-C1, RAM1751B1-C1, RAH1538B2-C1, RAM1538B2-C1, RAH1538B1-C1, RAM1538B1-C1.

Models RA(X)1225(Z)(W)-B, RA(X)8025(Z)(W)-C, RA(X)8038(Z)(W)-C, RA(X)9225(Z)(W)-C, RA(X)9238(Z)(W)-C, RA(X)9238(Z)(W), RA(X)1225(Z)(W)-C, RA(Y)1278(Z)(W), RA(X)1278(Z)(W)-C Series, where (W) may be 1 or 2, (X) may be H or M, (Y) may be H, M or L, (Z) may be B or S.

Model RAH2045S(W)-C, where the (W) may be 1 or 2.

Models RAH1245S2, RAH1747B2-C, RAH1759(X)2, where (X) may be B or S.

Models RAD8025B2, RAD9225B2, RAD8038B2, RAD9238B2, RAD1278B2, RAH2589B2-C, RAM2589B2-C, RCH1231S2-C, RCH1231B2-C, RAH6030S2, RAH6030B2.

Model RCL2720S1-C.

Model RAH1350S2.

Models REH175X62-2CR, REM220X63-2CR, RAH1238S2P, RCH2110S2-C.

Models REH133X61-2CN, REH175X47-2CN, REH175X62-2CN, REH180X49-2CN, REM180X49-2CN, REL180X49-2CN, REH190X62-2CN, REM190X62-2CN, REL190X62-2CN, REH220X63-2CN, REM220X63-2CN, REL220X63-2CN, REH225X90-2CN, REM225X90-2CN, REL225X90-2CN, REH252X84-2CN, REM252X84-2CN, REL252X84-2CN.

Models RCH2048S2-C, RCH2048S2-C1, RCH2258S2-C.

Models RCH1768S2, RCH1875S2-C.

Model REM225X90-1CN.

Model RCH1448S2.

Models RAH2589B2-C1, RAM2589B2-C1, RAL2589B2-C1, RAH2589B1-C1, RAM2589B1-C1, RAL2589B1-C1.

Model RCL4022B2-C.

Model REH190X62-1CN.

**Brushless DC fans**, Models RDM6025S, RDH6025S; Models RDL8025, RDM8025, RDL9025, RDM9025 with suffix "B" or "S" representing ball or sleeve bearing system respectively.

Models RDH4010B, RDH4010S, RDM4010B, RDM4010S, RDL4010B, RDL4010S, RDM4020S, RDH5210B, RDM5210B, RDL5210B, RDH5210S, RDM5210S, RDL5210S, RDH6020S, RDM6020S, RDL6020S, RDH8025B, RDH8025S, RDH9025B, RDH9025S, RDX4010Y1, RDX4010Y-1, RSX4010Y, where X may be H, M or L, Y may be S or B.

Models RDH4028S5, RDM4028S5, RDL4028S5, RDH4028B5, RDM4028B5, RDL4028B5, RDH4028S, RDM4028S, RDL4028S, RDH4028B, RDM4028B, RDL4028B.

**DC fans**, Models RDH1225B, RDH1225S, RDH1238B, RDH1238S, RDH4020B, RDH4020S, RDH6015B, RDH6015S, RDH8015B, RDH8015S, RDL1225B, RDL1225S, RDL1238B, RDL1238S, RDL4020B, RDL4020S, RDL6015B, RDL6015S, RDL8015B, RDL8015S, RDM1225B, RDM1225S, RDM1238B, RDM1238S, RDM6015B, RDM6015S, RDM8015B, RDM8015S, RDX8015Y1, where X may be H, M or L, Y may be S or B.

Models RDH5010B, RDH5010S, RDH6020B, RDH6025B, RDL5010B, RDL5010S, RDL6020B, RDL6025B, RDL6025S, RDM4020B, RDM5010B, RDM5010S, RDM6020B, RDM6025B.

Models RDH1232B DC12V, RDH1232B DC24V, RDH1232B DC48V, RDH1232S DC12V, RDH1232S DC24V, RDH1232S DC48V, RDL1232B DC12V, RDL1232B DC24V, RDL1232B DC48V, RDL1232S DC12V, RDL1232S DC24V, RDL1232S DC48V, RDM1232B DC12V, RDM1232B DC24V, RDM1232B DC48V, RDM1232S DC12V, RDM1232S DC24V, RDM1232S DC48V.

Model RDX1238YZ Series, where X may be H, M or L, Y may be S or B, Z may be 1, 2 or 4.

Models RDH3828y5, RDH3828y, RDH4020y5, RDL3828y5, RDL3828y, RDL4020y5, RDM3828y5, RDM3828y, RDM4020y5, RDD4020y5 Series, where y may be B or S.

Models RDH9232B, RDL9232B, RDM9232B.

Models RD(X)4010(Y)5, RD(X)4028(Y)2, RD(X)4510(Y)5, RD(X)4510(Y), RD(X)5010(Y)5, RD(X)5015(Y)5, RD(X)5015(Y), RD(X)6010B, RD(X)6015(Y)5, RD(X)6025(Y)2, RD(X)8020(Y), RD(X)8020(Y)2, RD(X)8025(Y)2, RD(X)9025(Y)2 Series, where (X) may be H, M or L, (Y) may be B or S.

Models RB(X)9733(Y), RB(X)9733(Y)2, RB(X)9733(Y)4 Series, where (X) may be H, M or L, (Y) may be B or S.

Models RBH5015S, RBM5015S, RBL5015S, RBH5015B, RBM5015B, RBL5015B, RDH9025S APF, RDM9025S APF, RDL9025S APF, RDH9025S BPF, RDM9025S BPF, RDL9025S BPF, RDH9025S APT, RDM9025S APT, RDL9025S APT, RDH9025S BPT, RDM9025S BPT, RDL9025S BPT, RDH9025S BGF, RDM9025S BGF, RDL9025S BGF, RBH1232B, RBM1232B, RBL1232B; RBH1232B2, RBM1232B2, RBL1232B2; RBH1232B4, RBM1232B4, RBL1232B4.

Models RD(A)2510(B)(C), RD(A)3010(B)(C), RD(A)7025(B)(E), RD(A)8025(B)(F) Series, DX-CF101, DX-CF102, DX-CF103, where (A) may be H, M or L, (B) may be S or B, (C) may be 5 or blank, (E) may be 2, 5 or blank, (F) may be L3 or L4.

Models RDH6015(Y)1, RSH6015(Y)1, RDH7015(Y)1, RDH7010(Y)(Z), RDM6015(Y)1, RSM6015(Y)1, RDM7015(Y)1, RDM7010(Y)(Z), RDL6015(Y)1, RSL6015(Y)1, RDL7015(Y)1, RDL7010(Y)(Z) Series, where (Y) may be S or B, (Z) may be 1 or 2.

Models RD(A)4010(B)2, RD(C)4020S2, RD(C)4020B2, RD(A)1225(B)2 Series, where (A) may be H, M or L, (B) may be S or B, (C) may be D, H, M or L.

Models RB(A)5015(B)(C), RB(D)7530(B)(E) Series, where (A) may be L, M or H, (B) may be S or B, (C) may be 2 or 5, (D) may be X, L, M, H or D, (E) may be 1, blank or 2.

Models RD(A)3006(D)5, RD(A)3006(D)1, RD(A)6010(D)1, RD(A)(C)(D)1(E), RD(B)(C)(D)2(E), RD(B)(C)(D)4(E) Series, where (A) may be H, M or L, (B) may be D, H, M, L or X, (C) may be 1555, 1725 or 1751, (D) may be B or S, (E) may be -3 or -5.

Model RS(A)4510(B)1 Series, where (A) may be H, M or L, (B) may be B or S.

Models RDH1225S1, RDM1225S1, RDL1225S1, RDH1225B1, RDM1225B1, RDL1225B1.

Models RDH4015(Y)1, RDM4015(Y)1, RDL4015(Y)1 Series, where (Y) may be S, B or C.

Model RDH9025(X)1 Series, where (X) may be S or B.

Models RDD8025(Y)1, RDH8025(Y)1, RDM8025(Y)1, RDL8025(Y)1, RDH8025(Y)5, RDM8025(Y)5, RDL8025(Y)5, where (Y) may be S or B.

Models RDD8025(X)4 Series, RDD8025(X)4-1 Series, RDH9025(X)4 Series, RBH1881B4, RBH1881B2, where (X) may be B or S.

Models RDL1238B6, RDH1232B6, RDL6025B6, RDL9025B6, RDH1225B6.

Models RDH1338B1, RDH1338B2, RDH1338B4, RDM1338B1, RDM1338B2, RDM1338B4, RDL1338B1, RDL1338B2, RDL1338B4Series.

Models RDH1225(Y)4, RDM1225(Y)4, RDL1225(Y)4, where (Y) may be B or S.

Models RG(X)4028(Y)1, RG(Z)4028(Y)2, RG(X)8038(Y)1, RG(X)8038(Y)2, RG(X)8038(Y)4 Series, where (X) may be D, H, M or L, (Z) may be H, M or L, (Y) may be S or B.

Model RSH6870(Y)1 series, where (Y) may be S or B.

Models RG(X)4056B1, RG(X)6038(Y)1, RG(X)6038(Y)2, RG(X)6038(Y)4 series, where (X) may be D, H, M or L, (Y) may be B or S.

Model RSM1130(Y)1 series, where (Y) may be B or S.

Models RD(X)8010(Y)5, RD(X)8010(Y)1 series, where (X) may be D, H, M or L, (Y) may be B or S.

**DC low voltage fans**, Models RDD1232(Y)4, RDD8015(Y)1, RD(X)5015(Y)2 Series, where (X) may be D, H, M or L, (Y) may be S or B.

Models RBH9330(Y)1, RBM9330(Y)1, RBL9330(Y)1, RBH9330(Y)1-1, RBM9330(Y)1-1, RBL9330(Y)1-1, RBH9330(Y)2, RBM9330(Y)2, RBL9330(Y)2, RBH9330(Y)2-1, RBM9330(Y)2-1, RBL9330(Y)2-1Series, where (Y) may be B or S.

Models RDH8025(Y)4, RDM8025(Y)4, RDL8025(Y)4, RDH9225(Y)1, RDM9225(Y)1, RDL9225(Y)1, RDH6025(Y)4, RDM6025(Y)4, RDL6025(Y)4, RDH5012(Y)1, RDM5012(Y)1, RDL5012(Y)1, RGD1238(Y)4, RGH1238(Y)4, RGM1238(Y)4, RGL1238(Y)4, RGH1238(Y)1, RGM1238(Y)1, RGL1238(Y)1, RGH1238(Y)2, RGM1238(Y)2, RGL1238(Y)2 Series, where (Y) may be S or B.

, Model RD(X)4025(Y)1 series, where (X) may be H, M or L; (Y) may be B or S.

Marking: Company name or tradenames "Heng Yang" or "RUILIAN SCIENCE" or trademark  , model designation and Recognized

Component Mark for Canada 

Last Updated on 2012-10-05

---

[Questions?](#)

[Print this page](#)

[Terms of Use](#)

[Page Top](#)

2012 UL LLC

When the UL Leaf Mark is on the product, or when the word "Environment" is included in the UL Mark, please search the [UL Environment database](#) for additional information regarding this product's certification.

The appearance of a company's name or product in this database does not in itself assure that products so identified have been manufactured under UL's Follow-Up Service. Only those products bearing the UL Mark should be considered to be Listed and covered under UL's Follow-Up Service. Always look for the Mark on the product.

UL permits the reproduction of the material contained in the Online Certification Directory subject to the following conditions: 1. The Guide Information, Designs and/or Listings (files) must be presented in their entirety and in a non-misleading manner, without any manipulation of the data (or drawings). 2. The statement "Reprinted from the Online Certifications Directory with permission from UL" must appear adjacent to the extracted material. In addition, the reprinted material must include a copyright notice in the following format: "© 2012 UL LLC".

# Zertifikat

# Certificate



Zertifikat Nr. *Certificate No.*  
R 50180055

Blatt *Page*  
0002

Ihr Zeichen <i>Client Reference</i>	Unser Zeichen <i>Our Reference</i>	Ausstellungsdatum	<i>Date of Issue</i> (day/mo/yr)
8578000960	ZTW2-SYC- 11020361 001	19.05.2010	

**Genehmigungsinhaber *License Holder***  
Xinruilian Science & Technology  
Co., Ltd.  
2F, No. 1 HsingHua St,  
TouNai, YunLin 630  
Taiwan, R.O.C.

**Fertigungsstätte *Manufacturing Plant***  
Xinruilian Electronics (Zhaoqing)  
Co., Ltd.  
Xijiang Industrial District  
Xiaoxiang, Gaoyao, Guangdong  
P.R. China

## Prüfzeichen *Test Mark*

## Geprüft nach *Tested acc. to*

EN 60335-1:2002+A1+A11+A12+A2+A13  
EN 60335-2-80:2003+A1+A2



**Zertifiziertes Produkt (Geräteidentifikation)**  
***Certified Product (Product Identification)***

**Lizenzentgelte - Einheit**  
***License Fee - Unit***

**Ventilator (AC Fan)**

Wie Blatt (As Page) 01

Ergänzung (Addition)

Bezeichnung (Type Designation) : RAX1238Y1 1

X steht für (stands for) : H, M oder (or) L 1

Y steht für (stands for) : B oder (or) S 1

Nennstrom (Rated Current) : 0.2A (RAH1238Y1)  
0.16A (RAM1238Y1)  
0.1A (RAL1238Y1)



3

**ANLAGE (Appendix): 1.0**

Dem Zertifikat liegt unsere Prüf- und Zertifizierungsordnung zugrunde und es bestätigt die Konformität des Produktes mit den oben genannten Standards und Prüfgrundlagen. Zusätzliche Anforderungen in Ländern, in denen das Produkt in Verkehr gebracht werden soll, müssen zusätzlich betrachtet werden. Die Herstellung des zertifizierten Produktes wird überwacht.

This certificate is based on our Testing and Certification Regulation and states the conformity of the product with the standards and testing requirements as indicated above. Any additional requirements in countries where the product is going to be marketed have to be considered additionally. The manufacturing of the certified product is subject to surveillance.

**Zertifizierungsstelle**

**TÜV Rheinland LGA Products GmbH - Tillystraße 2 - 90431 Nürnberg**  
Tel.: (+49/221)8 06 - 13 71 e-mail: cert-validity@de.tuv.com  
Fax: (+49/221)8 06 - 39 35 http://www.tuv.com/safety

**Dipl.-Ing. B. Scheirer**

# Zertifikat

# Certificate



Zertifikat Nr. *Certificate No.*  
R 50180055

Blatt *Page*  
0003

Ihr Zeichen *Client Reference*  
12063522

Unser Zeichen *Our Reference*  
ZTW2-YEL- 11020361 002

Ausstellungsdatum  
06.08.2013

*Date of Issue*  
(day/mo/yr)

**Genehmigungsinhaber *License Holder***

Xinruilian Science & Technology  
Co., Ltd.  
2F, No. 1 HsingHua St,  
TouNai, YunLin 630  
Taiwan, R.O.C.

**Fertigungsstätte *Manufacturing Plant***

Xinruilian Electronics (Zhaoqing)  
Co., Ltd.  
Xijiang Industrial District  
Xiaoxiang, Gaoyao, Guangdong 526122  
P.R. China

**Prüfzeichen *Test Mark***



**Geprüft nach *Tested acc. to***

EN 60335-1:2002+A1+A11+A12+A2+A13+A14+A15  
EN 60335-2-80:2003+A1+A2

**Zertifiziertes Produkt (Geräteidentifikation)  
*Certified Product (Product Identification)***

**Lizenzentgelte - Einheit  
*License Fee - Unit***

Ventilator (AC Fan)

Wie Blatt (As Page) 01

Änderung (Change)

Prüfgrundlage  
(Test Requirement)

: siehe oben  
(see above)



Dem Zertifikat liegt unsere Prüf- und Zertifizierungsordnung zugrunde und es bestätigt die Konformität des Produktes mit den oben genannten Standards und Prüfgrundlagen. Zusätzliche Anforderungen in Ländern, in denen das Produkt in Verkehr gebracht werden soll, müssen zusätzlich betrachtet werden. Die Herstellung des zertifizierten Produktes wird überwacht.

This certificate is based on our Testing and Certification Regulation and states the conformity of the product with the standards and testing requirements as indicated above. Any additional requirements in countries where the product is going to be marketed have to be considered additionally. The manufacturing of the certified product is subject to surveillance.

**TÜV Rheinland LGA Products GmbH - Tillystraße 2 - 90431 Nürnberg**  
Tel.: (+49/221)8 06 - 13 71 e-mail: cert-validity@de.tuv.com  
Fax: (+49/221)8 06 - 39 35 http://www.tuv.com/safety

**Zertifizierungsstelle**

Dipl.-Ing. M. Kröger



# C E R T I F I C A T E



of Conformity  
Low Voltage Directive 2006/95/EC

Registration No.: AN 50262492 0001

Report No.: 11020361 002

Holder: Xinruilian Science & Technology  
Co., Ltd.  
2F, No. 1 HsingHua St,  
TouNai, YunLin 630  
Taiwan, R.O.C.

Product: Fan  
(AC Fan)

Identification: RAX1238Y1  
X stands for: H, M or L  
Y stands for: B or S

This certificate of conformity is based on an evaluation of a sample of the above mentioned product. Technical Report and documentation are at the Licence Holder's disposal. This is to certify that the tested sample is in conformity with all revision of Annex I of Council Directive 2006/95/EC, in its latest amended version, referred to as the Low Voltage Directive. This certificate does not imply assessment of the series-production of the product and does not permit the use of a TÜV Rheinland mark of conformity. The holder of the certificate is authorized to use this certificate in connection with the EC declaration of conformity according to Annex III of the Directive.

Certification Body



Date 06.08.2013

  
Dipl.-Ing. M. Kröger

TÜV Rheinland LGA Products GmbH - Tillystraße 2 - 90431 Nürnberg

CE The CE marking may be used if all relevant and effective EC Directives are complied with. CE

## GUTACHTEN MIT FERTIGUNGSÜBERWACHUNG CERTIFICATE OF CONFORMITY WITH FACTORY SURVEILLANCE

Xinruilian Science & Technology  
(Shenzhen) Co., Ltd.  
Block A, Sanwei Industrial District  
Xixiang, Baoan  
518126 SHENZHEN  
CHINA

ist berechtigt, für ihr Produkt /  
is authorized to use for their product

**Einbauventilator für IT-Geräte**  
**Fan for building-in, IT-equipment**

die hier abgebildeten markenrechtlich geschützten Zeichen  
für die ab Blatt 2 aufgeführten Typen zu benutzen /  
the legally protected Marks as shown below for the types referred to on page 2 ff.



REG.-Nr. 122216 oder/or



oder/or VDE-REG.-Nr. 122216

REG.-Nr. 122216

Geprüft und zertifiziert nach /  
Tested and certified according to

DIN EN 60950-1 (VDE 0805 Teil 1):2011-01; EN 60950-1:2006 + A11:2009 + A1:2010  
DIN EN 60950-1/A12 (VDE 0805-1/A12):2011-08; EN 60950-1/A12:2011-02

VDE Prüf- und Zertifizierungsinstitut GmbH  
VDE Testing and Certification Institute  
Zertifizierungsstelle / Certification

VDE Zertifikate sind nur gültig bei Veröffentlichung unter:  
VDE certificates are valid only when published on:

Aktenzeichen: 2315400-2611-0001 / 158229  
File ref.:

Ausweis-Nr. 122216 Blatt 1  
Certificate No. Page

Weitere Bedingungen siehe Rückseite und Folgeblätter /  
further conditions see overleaf and following pages

Offenbach, 2000-11-09  
(letzte Änderung/updated 2012-02-22 )

<http://www.vde.com/zertifikat>  
<http://www.vde.com/certificate>

Name und Sitz des Genehmigungs-Inhabers / *Name and registered seat of the Certificate holder*  
Xinruilian Science & Technology (Shenzhen) Co., Ltd., Block A, Sanwei Industrial District, Xixiang,  
Baoan, 518126 SHENZHEN, Guangdong, CHINA

Aktenzeichen / *File ref.*  
2315400-2611-0001 / 158229 / FG13 / S

letzte Änderung / *updated* Datum / *Date*  
2012-02-22 2000-11-09

Dieses Blatt gilt nur in Verbindung mit Blatt 1 des Gutachtens mit Fertigungsüberwachung Nr. 122216.  
*This supplement is only valid in conjunction with page 1 of the Certificate of Conformity with factory surveillance No. 122216.*

**Einbauventilator für IT-Geräte**  
***Fan for building-in, IT-equipment***

Typ(en) / *Type(s)*:

**RAH1238B1**  
**RAM1238B1**  
**RAL1238B1**  
**RAH1238S1**  
**RAM1238S1**  
**RAL1238S1**

Nennspannung AC 220-240 V / 50/60Hz  
*Rated voltage*

Nennstrom max. 200mA  
*Rated current*

Schutzklasse I  
*Class*

Umgebungstemperatur max. 50°C  
*Ambient temperature*

Einbaubedingungen Beim Einbau des genehmigten Erzeugnisses, der  
entsprechend der zugehörigen Installationsan-  
leitung zu erfolgen hat, ist darauf zu achten,  
daß alle Anforderungen gemäß der oben genannten  
Bestimmung(en) eingehalten sind.  
*Built-in requirements For the installation of the certified equipment,  
which has to be carried out according to the  
respective installation manual, all requirements  
of the standards mentioned above have to be  
fulfilled.*

Weitere Angaben siehe Anlage Nr. 3 / see Appendix No. 3  
*Further information*

Fortsetzung siehe Blatt 3 /  
*continued on page 3*

Name und Sitz des Genehmigungs-Inhabers / *Name and registered seat of the Certificate holder*

Xinruilian Science & Technology (Shenzhen) Co., Ltd., Block A, Sanwei Industrial District, Xixiang,  
Baoan, 518126 SHENZHEN, Guangdong, CHINA

Aktenzeichen / *File ref.*

2315400-2611-0001 / 158229 / FG13 / S

letzte Änderung / *updated* Datum / *Date*

2012-02-22 2000-11-09

Dieses Blatt gilt nur in Verbindung mit Blatt 1 des Gutachtens mit Fertigungsüberwachung Nr. 122216.

*This supplement is only valid in conjunction with page 1 of the Certificate of Conformity with factory surveillance No. 122216.*

Dieser Zeichengenehmigungs-Ausweis bildet eine Grundlage für die EG-Konformitätserklärung und CE-Kennzeichnung durch den Hersteller oder dessen Bevollmächtigten und bescheinigt die Konformität mit den grundlegenden Schutzanforderungen der **EG-Niederspannungsrichtlinie 2006/95/EG** mit ihren Änderungen.

*This Marks Approval is a basis for the EC Declaration of Conformity and the CE Marking by the manufacturer or his agent and proves the conformity with the essential safety requirements of the **EC Low-Voltage Directive 2006/95/EC** including amendments.*

VDE Prüf- und Zertifizierungsinstitut GmbH  
*VDE Testing and Certification Institute*  
Fachgebiet FG13  
*Section FG13*

# VDE Prüf- und Zertifizierungsinstitut Gutachten mit Fertigungsüberwachung

Ausweis-Nr. / Beiblatt /  
Certificate No. Supplement  
122216

Name und Sitz des Genehmigungs-Inhabers / *Name and registered seat of the Certificate holder*

Xinruilian Science & Technology (Shenzhen) Co., Ltd., Block A, Sanwei Industrial District, Xixiang,  
Baoan, 518126 SHENZHEN, Guangdong, CHINA

Aktenzeichen / *File ref.*

2315400-2611-0001 / 158229 / FG13 / S

letzte Änderung / *updated* Datum / *Date*

2012-02-22

2000-11-09

Dieses Beiblatt ist Bestandteil des Gutachtens mit Fertigungsüberwachung Nr. 122216.

*This supplement is part of the Certificate of Conformity with factory surveillance No. 122216.*

## Einbauventilator für IT-Geräte *Fan for building-in, IT-equipment*

### Fertigungsstätte(n)

*Place(s) of manufacture*

Referenz/*Reference*

**30019216**

Xinruilian Electronics  
(Zhaoqing) Co. Ltd.  
Xijiang Industrial District  
526122 XIAOXIANG, GAOYAO  
Guangdong  
CHINA

VDE Prüf- und Zertifizierungsinstitut GmbH

*VDE Testing and Certification Institute*

Fachgebiet FG13

*Section FG13*

# VDE Prüf- und Zertifizierungsinstitut Gutachten mit Fertigungsüberwachung

Ausweis-Nr. / Infoblatt /  
Certificate No. Info sheet  
122216

Name und Sitz des Genehmigungs-Inhabers / *Name and registered seat of the Certificate holder*

Xinruilian Science & Technology (Shenzhen) Co., Ltd., Block A, Sanwei Industrial District, Xixiang, Baoan, 518126 SHENZHEN, Guangdong, CHINA

Aktenzeichen / *File ref.*

2315400-2611-0001 / 158229 / FG13 / S

letzte Änderung / *updated* Datum / *Date*

2012-02-22 2000-11-09

Dieses Blatt gilt nur in Verbindung mit Blatt 1 des Gutachtens mit Fertigungsüberwachung Nr. 122216.

*This supplement is only valid in conjunction with page 1 of the Certificate of Conformity with factory surveillance No. 122216.*

## **Genehmigung zum Benutzen des auf Seite 1 abgebildeten markenrechtlich geschützten Zeichens des VDE:**

Grundlage für die Benutzung sind die Allgemeinen Geschäftsbedingungen (AGB) der VDE Prüf- und Zertifizierungsinstitut GmbH ([www.vde.com\AGB-Institut](http://www.vde.com\AGB-Institut)). Das Recht zur Benutzung erstreckt sich nur auf die bezeichnete Firma mit den genannten Fertigungsstätten und die oben aufgeführten Produkte mit den zugeordneten Bezeichnungen. Die Fertigungsstätte muss so eingerichtet sein, dass eine gleichmäßige Herstellung der geprüften und zertifizierten Ausführung gewährleistet ist.

Die Genehmigung ist so lange gültig wie die VDE-Bestimmungen gelten, die der Zertifizierung zugrunde gelegen haben, sofern sie nicht auf Grund anderer Bedingungen aus der VDE Prüf- und Zertifizierungsordnung (PM102) zurückgezogen werden muss.

Der Gültigkeitszeitraum einer VDE-GS-Zeichengenehmigung kann auf Antrag verlängert werden. Bei gesetzlichen und / oder normativen Änderungen kann die VDE-GS-Zeichengenehmigung ihre Gültigkeit zu einem früheren als dem angegebenen Datum verlieren.

Produkte, die das Biozid Dimethylfumarat (DMF) enthalten, dürfen gemäß der Kommissionsentscheidung 2009/251/EG nicht mehr in den Verkehr gebracht oder auf dem Markt bereitgestellt werden.

Der VDE-Zeichengenehmigungsausweis wird ausschließlich auf der ersten Seite unterzeichnet.

### **Approval to use the legally protected Mark of the VDE as shown on the first page:**

*Basis for the use are the general terms and conditions of the VDE Testing and Certification Institute ([www.vde.com\terms-institute](http://www.vde.com\terms-institute)). The right to use the mark is granted only to the mentioned company with the named places of manufacture and the listed products with the related type references. The place of manufacture shall be equipped in a way that a constant manufacturing of the certified construction is assured.*

*The approval is valid as long as the VDE specifications are in force, on which the certification is based on, unless it is withdrawn according to the VDE Testing and Certification Procedure (PM102E).*

*The validity period of a VDE-GS-Mark Approval may be prolonged on request. In case of changes in legal and / or normative requirements, the validity period of a VDE-GS-Mark Approval may be shortened.*

*Products containing the biocide dimethylfumarate (DMF) may not be marketed or made available on the EC market according to the Commission Decision 2009/251/EC.*

*The approval is solely signed on the first page.*