

Outline dimensions:

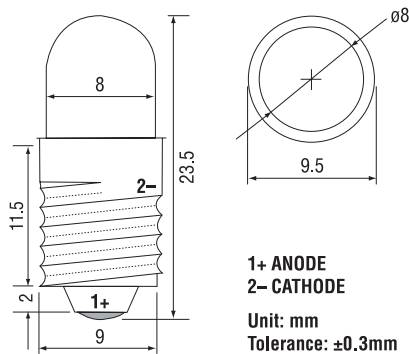

Directivity:

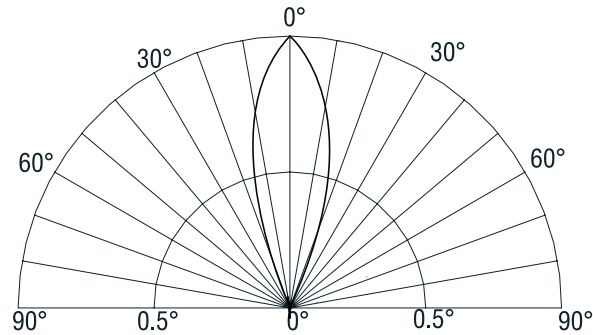

Features:

- AC/DC Operation
- Viewing angle 30°

Absolute maximum rating (Ta=25°C)

Item	Symbol	Value		Unit
		PG/UB/PW	HR/OR/YL	
Pulse forward current*	I_{FP}	100	150	mA
Power dissipation	P_D	240	240	mW
Operating temperature	T_{opr}	-30 to +80	-30 to +80	°C
Storage temperature	T_{stg}	-30 to +100	-30 to +100	°C

*Pulse width max. 10ms. Duty ratio max. 1/10

Electrical - Optical characteristics (Ta=25°C)

Emitting colour	Lens type	Forward voltage VF (V)		Chromaticity coordinates ²				Luminous intensity IV (mcd) ¹	
		AC	DC	X		Y			
		Working current: IF = 20mA							
		Typ.	Max.	Min.	Max.	Min.	Max.	Typ.	Max.
White	Water clear	6	8	0.26	0.29	0.25	0.28	8400	10000

1 Axial direction (luminous intensity)

2 According to CIE 1931 chromaticity diagram